



PRIUS+

PRIUSV

Gasoline-Electric

Hybrid Synergy Drive

***HYBRID VEHICLE
DISMANTLING
MANUAL***



Foreword

This guide was developed to educate and assist dismantlers in the safe handling of Toyota PRIUS +/PRIUS v gasoline-electric hybrid vehicles. PRIUS +/PRIUS v dismantling procedures are similar to other non-hybrid Toyota vehicles with the exception of the high voltage electrical system. It is important to recognize and understand the high voltage electrical system features and specifications of the Toyota PRIUS +/PRIUS v hybrid, as they may not be familiar to dismantlers.

High voltage electricity powers the A/C compressor, electric motor, generator, and inverter/converter. All other conventional automotive electrical devices such as the headlights, radio, and gauges are powered from a separate 12 Volt auxiliary battery. Numerous safeguards have been designed into the PRIUS +/PRIUS v to help ensure the high voltage, approximately 201.6 Volt, Lithium-ion (Li-ion) Hybrid Vehicle (HV) battery assembly is kept safe and secure in an accident.

The Li-ion HV battery assembly contains sealed batteries that are similar to rechargeable batteries used in some battery operated power tools and other consumer products. The electrolyte is absorbed in the cell plates and will not normally leak out even if the battery is cracked. In the unlikely event the electrolyte does leak, it can be easily neutralized with a dilute boric acid solution or vinegar.

High voltage cables, identifiable by orange insulation and connectors, are isolated from the metal chassis of the vehicle.

Additional topics contained in the guide include:

- Toyota PRIUS +/PRIUS v identification.
- Major hybrid component locations and descriptions.

By following the information in this guide, dismantlers will be able to handle PRIUS +/PRIUS v-electric vehicles as safely as the dismantling of a conventional non-hybrid automobile.

© 2012 Toyota Motor Corporation

All rights reserved. This book may not be reproduced or copied, in whole or in part, without the written permission of Toyota Motor Corporation.

Table of Contents

<u>About the PRIUS +/PRIUS v</u>	<u>1</u>
<u>PRIUS +/PRIUS v Identification</u>	<u>2</u>
Exterior	3
<u>PRIUS +/PRIUS v Identification (Continued)</u>	<u>4</u>
Interior.....	4
Engine Compartment	5
<u>Hybrid Component Locations & Descriptions</u>	<u>6</u>
Specifications	7
<u>Hybrid Synergy Drive Operation</u>	<u>8</u>
Vehicle Operation.....	8
<u>Hybrid Vehicle (HV) Battery Assembly and Auxiliary Battery</u>	<u>9</u>
HV Battery Assembly	9
Components Powered by the HV Battery Assembly	9
HV Battery Assembly Recycling.....	10
Auxiliary Battery	10
<u>High Voltage Safety</u>	<u>11</u>
High Voltage Safety System.....	11
Service Plug Grip	12
<u>Precaution to be observed when dismantling the vehicle</u>	<u>13</u>
Necessary Items	13
<u>Spills</u>	<u>14</u>
<u>Dismantling the vehicle</u>	<u>15</u>
<u>Removal of HV battery</u>	<u>19</u>
HV Battery Caution Label	28

About the PRIUS +/PRIUS v

The PRIUS +/PRIUS v wagon joins the PRIUS, CAMRY hybrid and AURIS hybrid as a hybrid model for Toyota. *Hybrid Synergy Drive* means that the vehicle contains a gasoline engine and an electric motor for power. The two hybrid power sources are stored on board the vehicle:

1. Gasoline stored in the fuel tank for the gasoline engine.
2. Electricity stored in a high voltage Hybrid Vehicle (HV) battery assembly for the electric motor.

The result of combining these two power sources is improved fuel economy and reduced emissions. The gasoline engine also powers an electric generator to recharge the battery assembly; unlike a pure all electric vehicle, the PRIUS +/PRIUS v never needs to be recharged from an external electric power source.

Depending on the driving conditions one or both sources are used to power the vehicle. The following illustration demonstrates how the PRIUS +/PRIUS v operates in various driving modes.

- ❶ During light acceleration at low speeds, the vehicle is powered by the electric motor. The gasoline engine is shut off.
- ❷ During normal driving, the vehicle is powered mainly by the gasoline engine. The gasoline engine also powers the generator to recharge the battery assembly and drive to the electric motor.
- ❸ During full acceleration, such as climbing a hill, both the gasoline engine and the electric motor power the vehicle.
- ❹ During deceleration, such as when braking, the vehicle regenerates the kinetic energy from the wheels to produce electricity that recharges the battery assembly.
- ❺ While the vehicle is stopped, the gasoline engine and electric motor are off, however the vehicle remains on and operational.

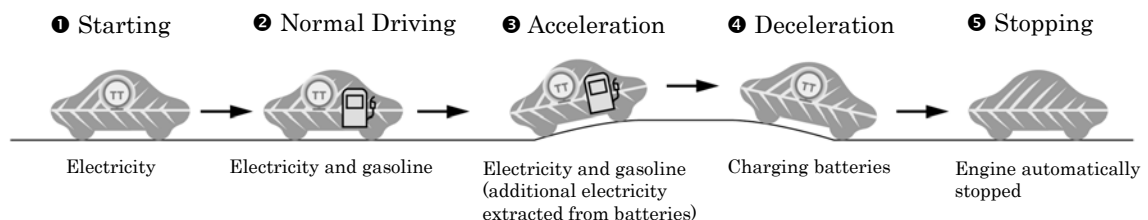

PRIUS +/PRIUS v Identification

In appearance, the PRIUS +/PRIUS v is a 5-door wagon. Exterior, interior, and engine compartment illustrations are provided to assist in identification.

The alphanumeric 17 character Vehicle Identification Number (VIN) is provided in the front windshield cowl, right side floor and on the left side B pillar.

Example VIN: JTDZS3EU0C3000101

A PRIUS +/PRIUS v is identified by the first 8 alphanumeric characters **JTDZS3EU**.

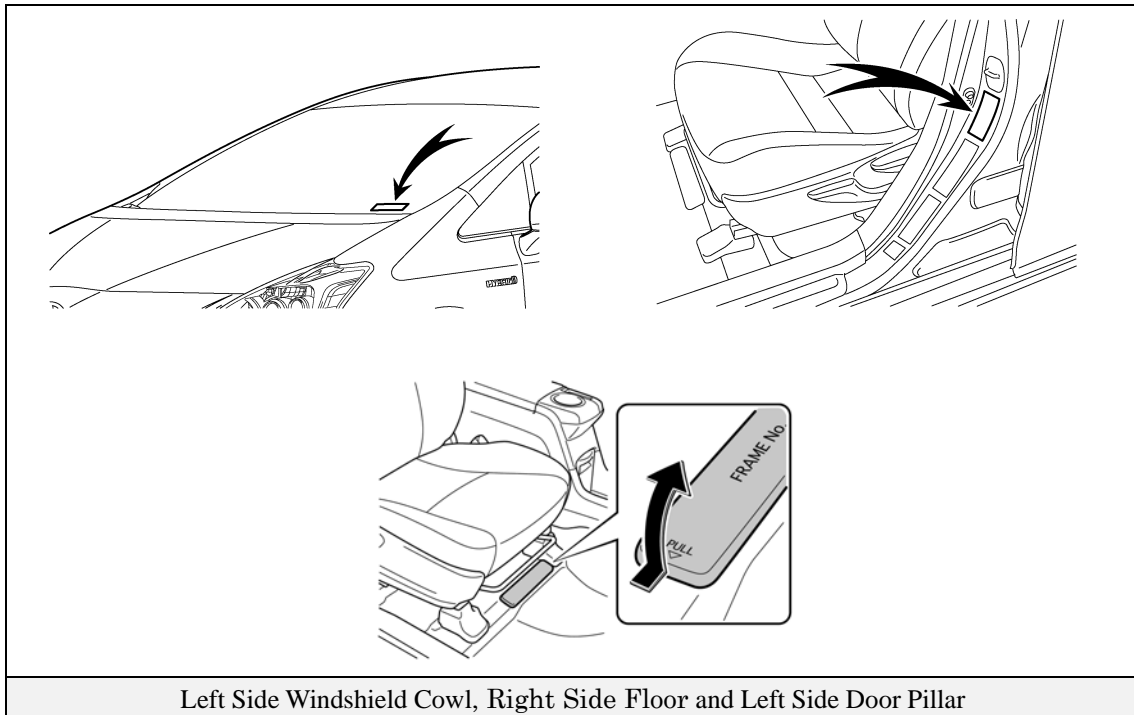

Left Side Windshield Cowl, Right Side Floor and Left Side Door Pillar

PRIUS +/PRIUS v Identification (Continued)

Exterior

- ❶ Name plate and  logos on the back door.
- ❷  logo on each front fender.

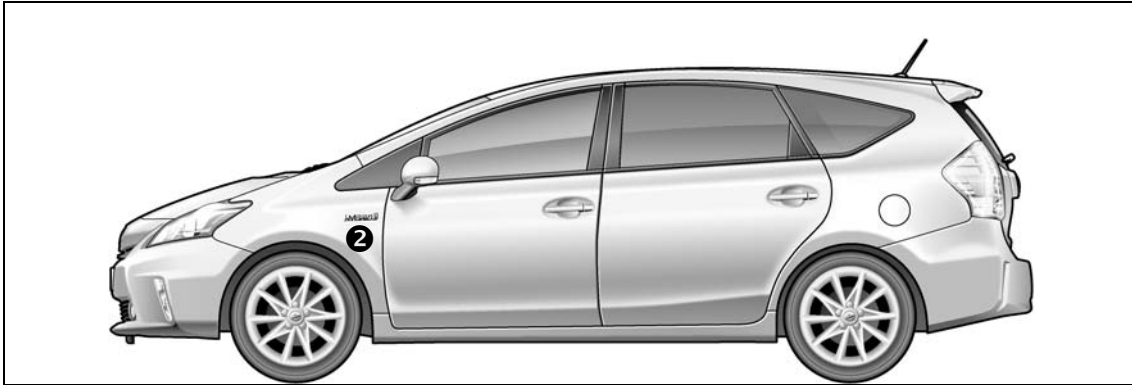

Exterior Left Side View

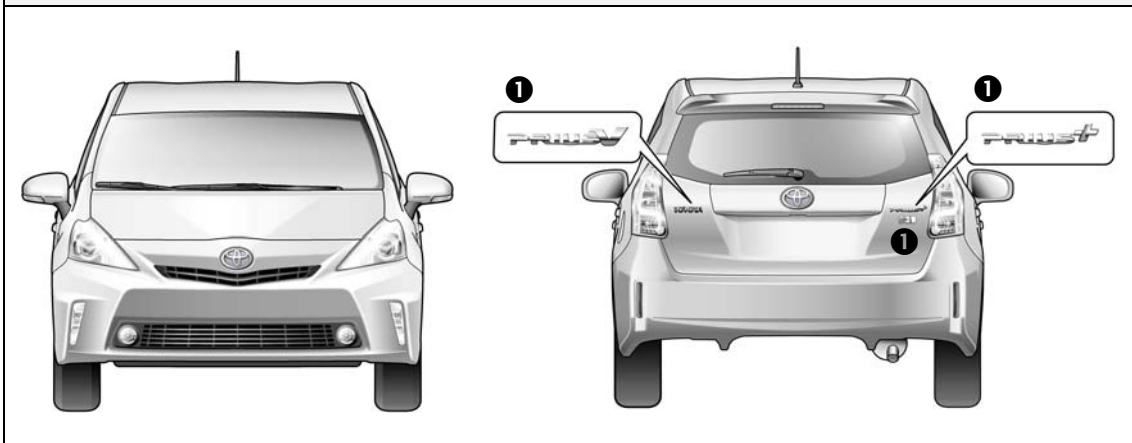

Exterior Front View and Rear View

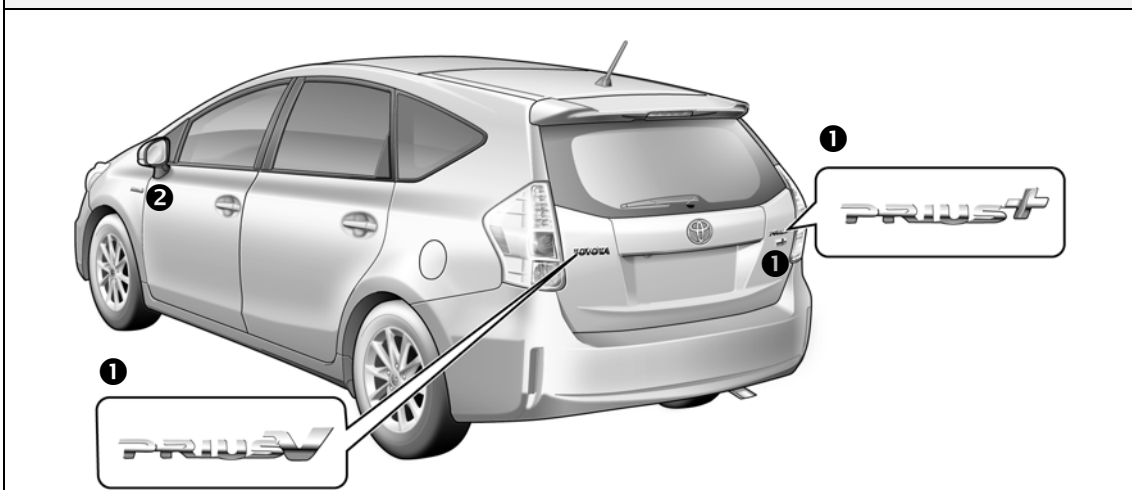

Exterior Rear and Left Side View

PRIUS +/PRIUS v Identification (Continued)

Interior

- ③ Instrument cluster (**READY** indicator, shift state indicators) located in center of the dash and near the base of the windshield.

Hint:

If the vehicle is shut off, the instrument cluster gauges will be “blacked out”, not illuminated.

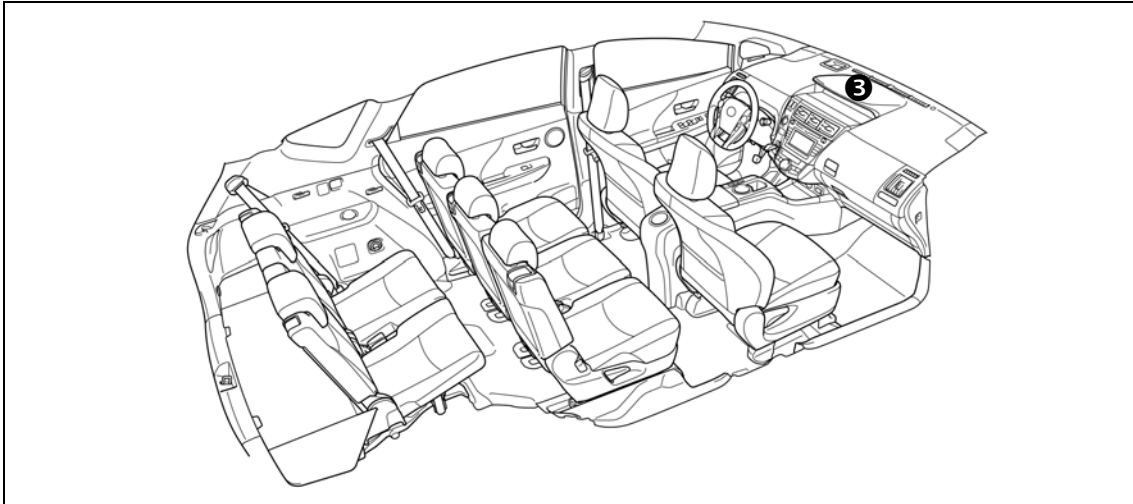

Interior View

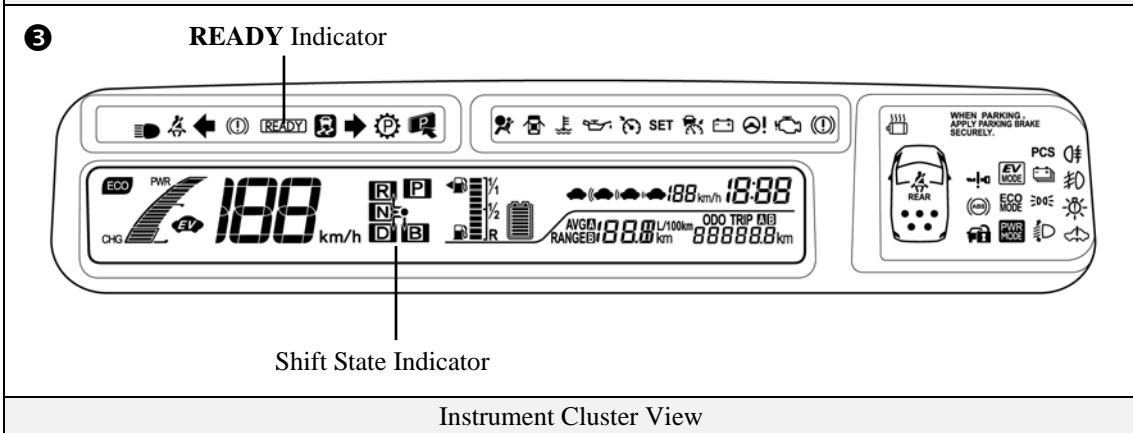

Instrument Cluster View

PRIUS +/PRIUS v Identification (Continued)

Engine Compartment

- ④ 1.8-liter aluminum alloy gasoline engine.
- ⑤ Logo on the plastic engine cover.
- ⑥ Orange colored high voltage power cables.

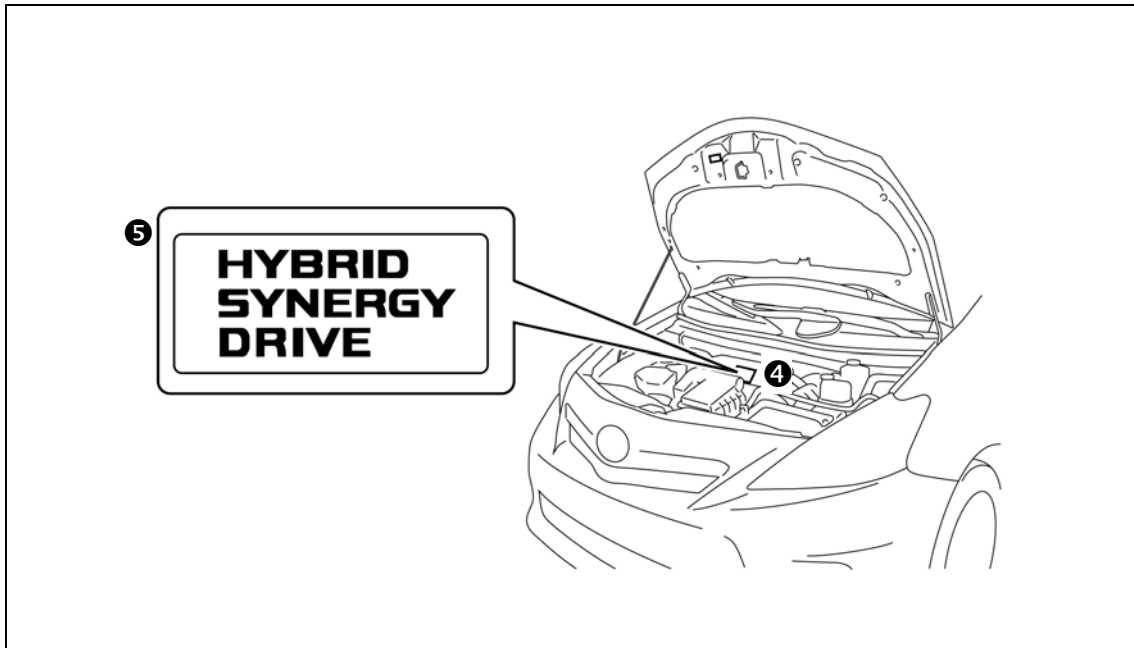

Engine Compartment View

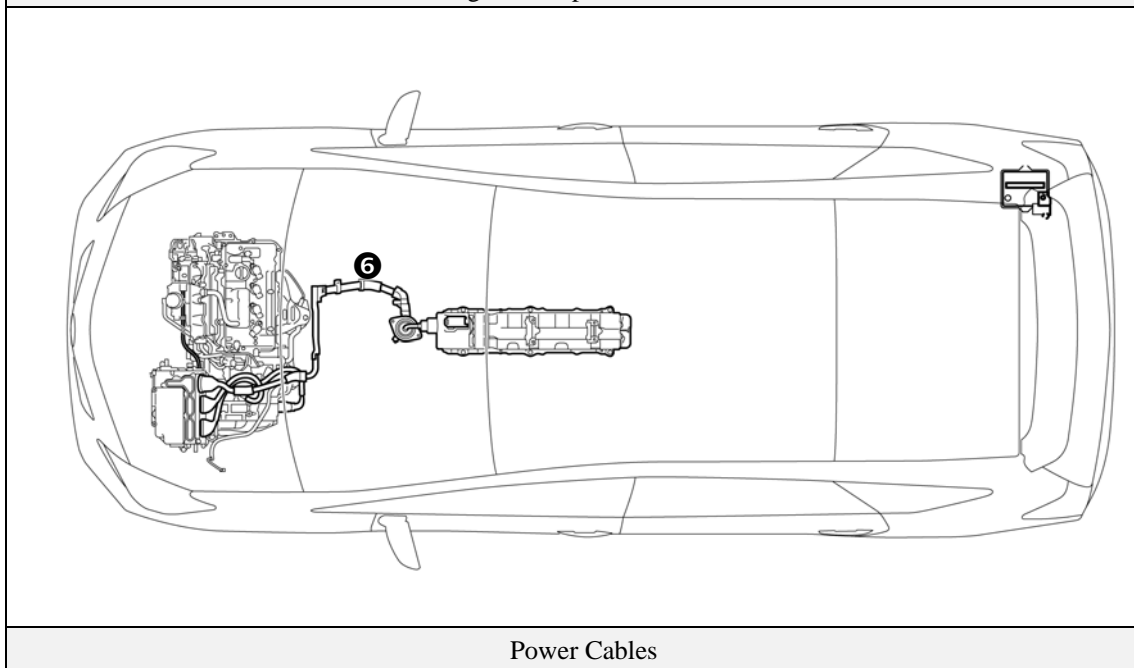

Power Cables

Hybrid Component Locations & Descriptions

Component	Location	Description
12 Volt ❶ Auxiliary Battery	Right Side of Cargo Area	A lead-acid battery that supplies power to the low voltage devices.
Hybrid ❷ Vehicle (HV) Battery Assembly	Center Console	201.6 Volt Lithium-ion (Li-ion) battery assembly consisting of 56 low voltage (3.6 Volt) cells connected in series.
Power ❸ Cables	Undercarriage and Engine Compartment	Orange colored power cables carry high voltage Direct Current (DC) between the HV battery assembly, inverter/converter, and A/C compressor. These cables also carry 3-phase Alternating Current (AC) between the inverter/converter, electric motor, and generator.
Inverter/Converter ❹	Engine Compartment	Boosts and inverts the high voltage electricity from the HV battery assembly to 3-phase AC electricity that drives the electric motors. The inverter/converter also converts AC electricity from the electric generator and electric motors (regenerative braking) to DC that recharges the HV battery assembly.
Gasoline ❺ Engine	Engine Compartment	Provides two functions: 1) Powers vehicle. 2) Powers generator to recharge the HV battery assembly. The engine is started and stopped under control of the vehicle computer.
Electric ❻ Motor	Engine Compartment	3-phase high voltage AC motor contained in the front transaxle. It is used to power the front wheels.
Electric ❼ Generator	Engine Compartment	3-phase high voltage AC generator that is contained in the transaxle and recharges the HV battery assembly.
A/C Compressor (with Inverter) ❸	Engine Compartment	3-phase high voltage AC electrically driven motor compressor.
Fuel Tank and Fuel Line ❹	Undercarriage and Center	The fuel tank provides gasoline via a fuel line to the engine. The fuel line is routed under the center of vehicle.

*Numbers in the component column apply to the illustrations on the following page.

Hybrid Component Locations & Descriptions (Continued)

Specifications

- Gasoline Engine: 98 hp (73 kW), 1.8-liter Aluminum Alloy Engine
- Electric Motors 80 hp (60 kW), AC Motor
- Transmission: Automatic Only (electrically controlled continuously variable transaxle)
- HV Battery: 201.6 Volt Sealed Li-ion-Battery
- Curb Weight: 3,450 lbs/1,565 kg
- Fuel Tank: 11.9 gals/45.0 liters
- Frame Material: Steel Unibody
- Body Material: Steel Panels except for Aluminum Hood and Optional Polycarbonate Roof
- Seating Capacity: 7 passenger

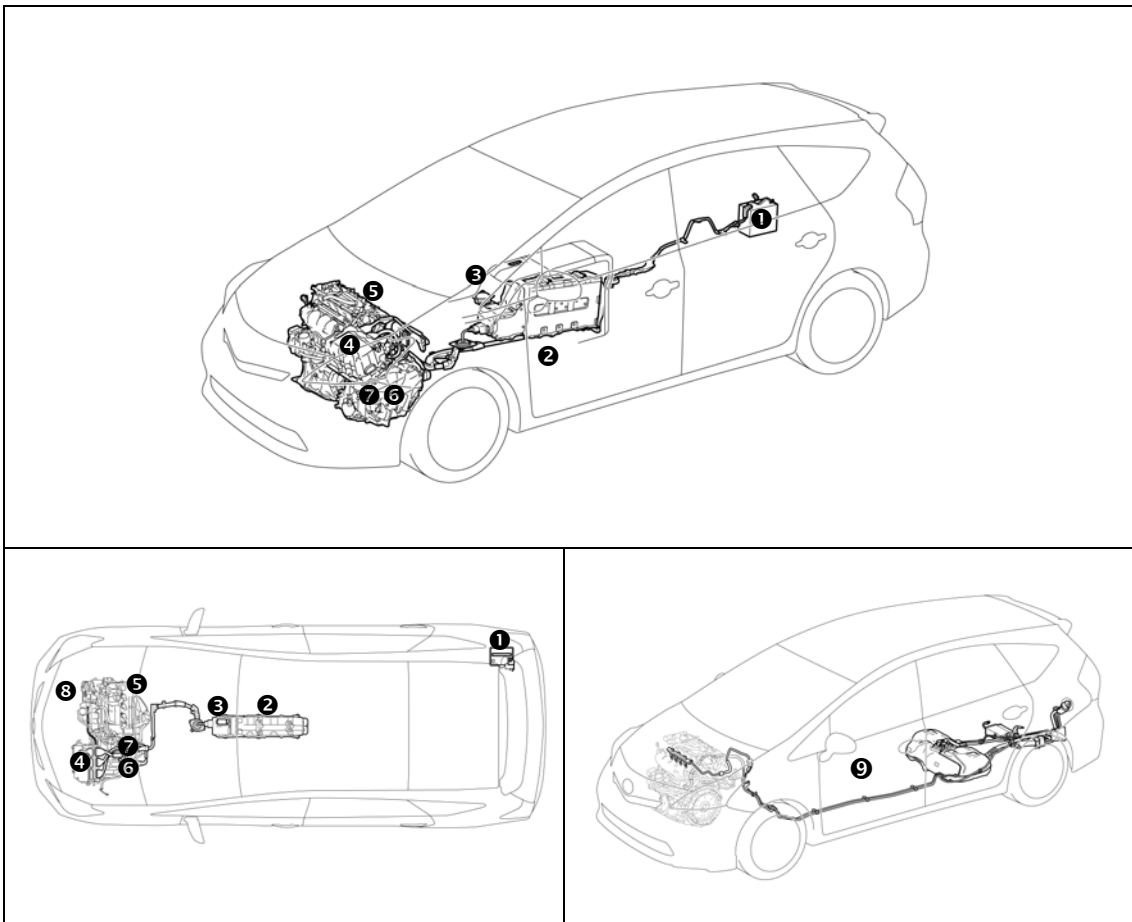

Hybrid Synergy Drive Operation

Once the **READY** indicator is illuminated in the instrument cluster, the vehicle may be driven. However, the gasoline engine does not idle like a typical automobile and will start and stop automatically. It is important to recognize and understand the **READY** indicator provided in the instrument cluster. When illuminated, it informs the driver that the vehicle is on and operational even though the gasoline engine may be off and the engine compartment is silent.

Vehicle Operation

- With the PRIUS +/PRIUS v, the gasoline engine may stop and start at any time while the **READY** indicator is on.
- Never assume that the vehicle is shut off just because the engine is off. Always look for the **READY** indicator status. The vehicle is shut off when the **READY** indicator is off.

The vehicle may be powered by:

1. The electric motor only.
2. A combination of both the electric motor and the gasoline engine.

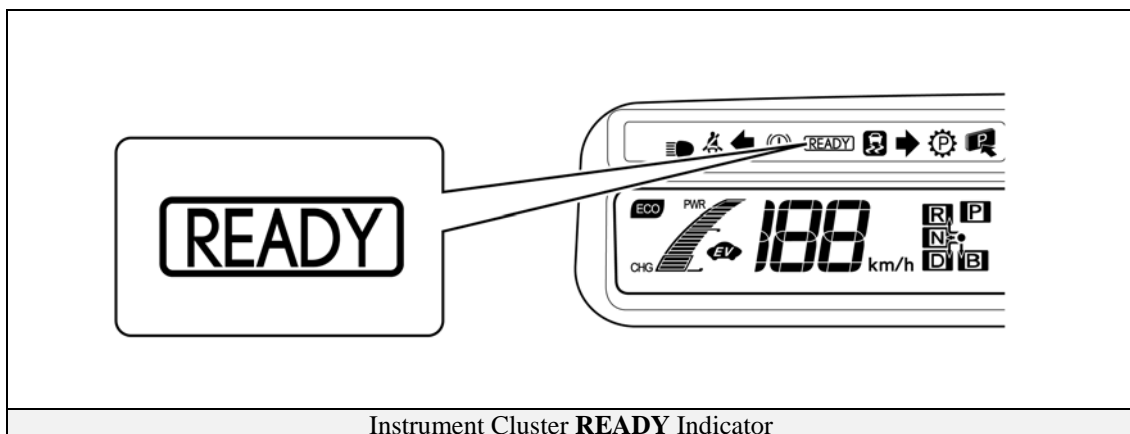

Hybrid Vehicle (HV) Battery Assembly and Auxiliary Battery

The PRIUS +/PRIUS v features a high voltage Hybrid Vehicle (HV) battery assembly that contains sealed Lithium-ion (Li-ion) battery cells.

HV Battery Assembly

- The HV battery assembly is enclosed in a metal case and is rigidly mounted in the center console. The metal case is isolated from high voltage.
- The HV battery assembly consists of 56 low voltage (3.6 Volt) Li-ion battery cells connected in series to produce approximately 201.6 Volts. Each Li-ion battery cell is non-spillable and in a sealed case.
- The electrolyte used in the Li-ion battery cells is a flammable organic electrolyte. The electrolyte is absorbed into the battery cell separator and will not normally leak, even in a collision.

HV Battery Assembly	
Battery assembly voltage	201.6 V
Number of Li-ion battery cells in the pack	56
Li-ion battery cell voltage	3.6 V
Li-ion battery cell dimensions	4.4 x 0.6 x 4.4 in (111 x 14 x 112 mm)
Li-ion cell weight	0.55 lbs (0.25 kg)
Li-ion battery assembly dimensions	32.7 x 8.7 x 14.6 in (830 x 220 x 370 mm)
Li-ion battery assembly weight	69 lbs (31.5 kg)

Components Powered by the HV Battery Assembly

- Electric Motor
- Power Cables
- Electric Generator
- Inverter/Converter Motor
- A/C Compressor

Hybrid Vehicle (HV) Battery Assembly and Auxiliary Battery (Continued)

HV Battery Assembly Recycling

- The HV battery assembly is recyclable. Contact either your Toyota Distributor as mentioned on HV battery Caution Label (see page 28) or the nearest Toyota dealer.

Auxiliary Battery

- The PRIUS +/PRIUS v also contains a lead-acid 12 Volt battery. This 12 Volt auxiliary battery powers the vehicle electrical system similar to a conventional vehicle. As with other conventional vehicles, the auxiliary battery is grounded to the metal chassis of the vehicle.
- The auxiliary battery is located in the cargo area. It is concealed by the deck board and auxiliary box on the right side in the rear quarter panel well.

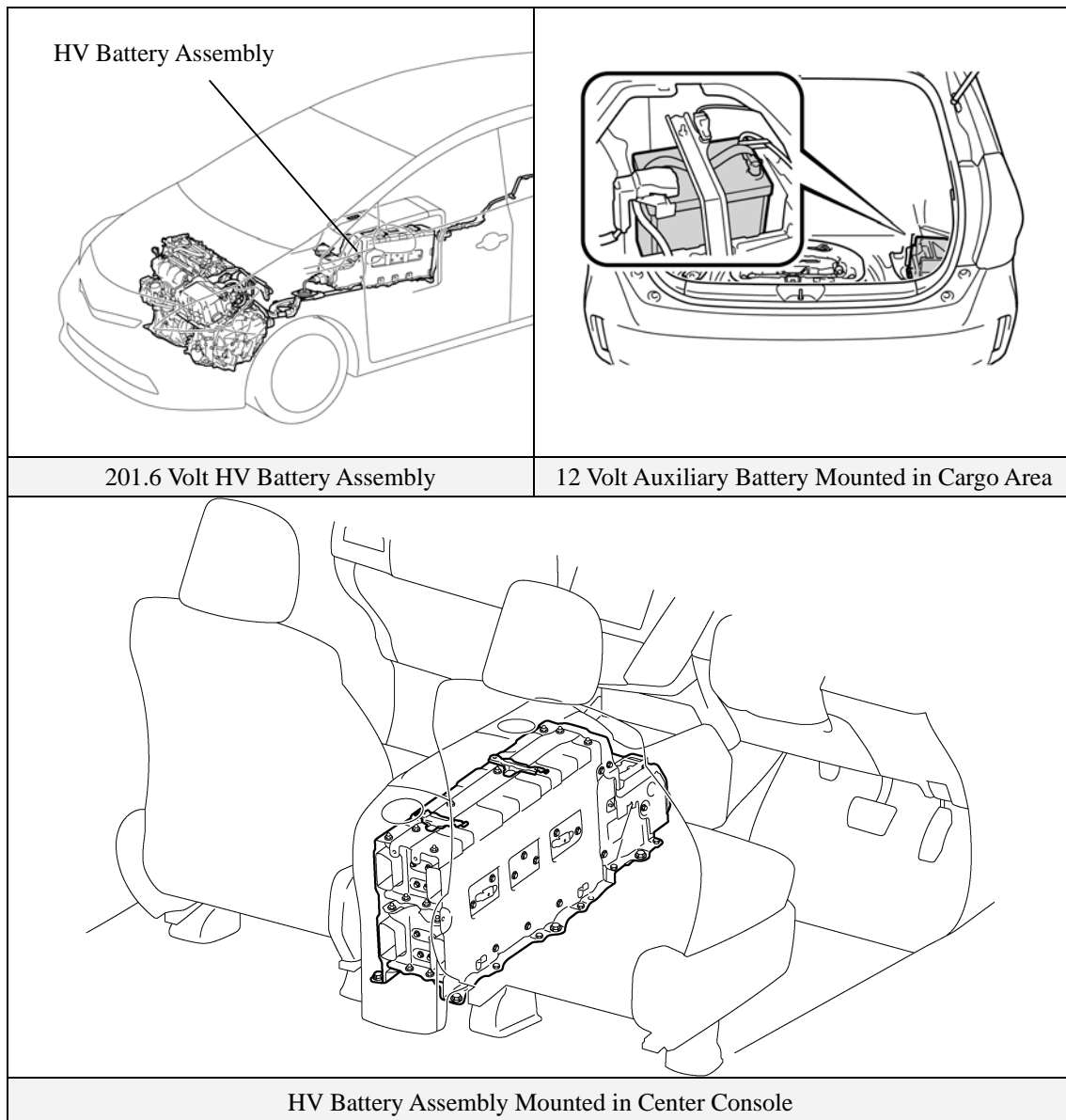

High Voltage Safety

The HV battery assembly powers the high voltage electrical system with DC electricity. Positive and negative orange colored high voltage power cables are routed from the battery assembly, under the vehicle floor pan, to the inverter/converter. The inverter/converter contains a circuit that boosts the HV battery voltage from 201.6 to 650 Volts DC. The inverter/converter creates 3-phase AC to power the motors. Power cables are routed from the inverter/converter to each high voltage motor (electric motor, electric generator, and A/C compressor). The following systems are intended to help keep occupants in the vehicle and emergency responders safe from high voltage electricity:

High Voltage Safety System

- A high voltage fuse ❶* provides short circuit protection in the HV battery assembly.
- Positive and negative high voltage power cables ❷* connected to the HV battery assembly are controlled by 12 Volt normally open relays ❸*. When the vehicle is shut off, the relays stop electricity flow from leaving the HV battery assembly.



WARNING:

- ***The high voltage system may remain powered for up to 10 minutes after the vehicle is shut off or disabled. To prevent serious injury or death from severe burns or electric shock, avoid touching, cutting, or opening any orange high voltage power cable or high voltage component.***

- Both positive and negative power cables ❷* are insulated from the metal chassis, so there is no possibility of electric shock when touching the metal chassis.
- A ground-fault monitor continuously monitors for high voltage leakage to the metal chassis while the vehicle is running. If a malfunction is detected, the hybrid vehicle computer ❹* will illuminate the hybrid system warning light  in the instrument cluster.
- The HV battery assembly relays will automatically open to stop electricity flow in a collision sufficient to activate the SRS.

*Numbers apply to the illustration on the following page.

High Voltage Safety (Continued)

Service Plug Grip

- The high-voltage circuit is cut by removing the service plug grip (see page 15).

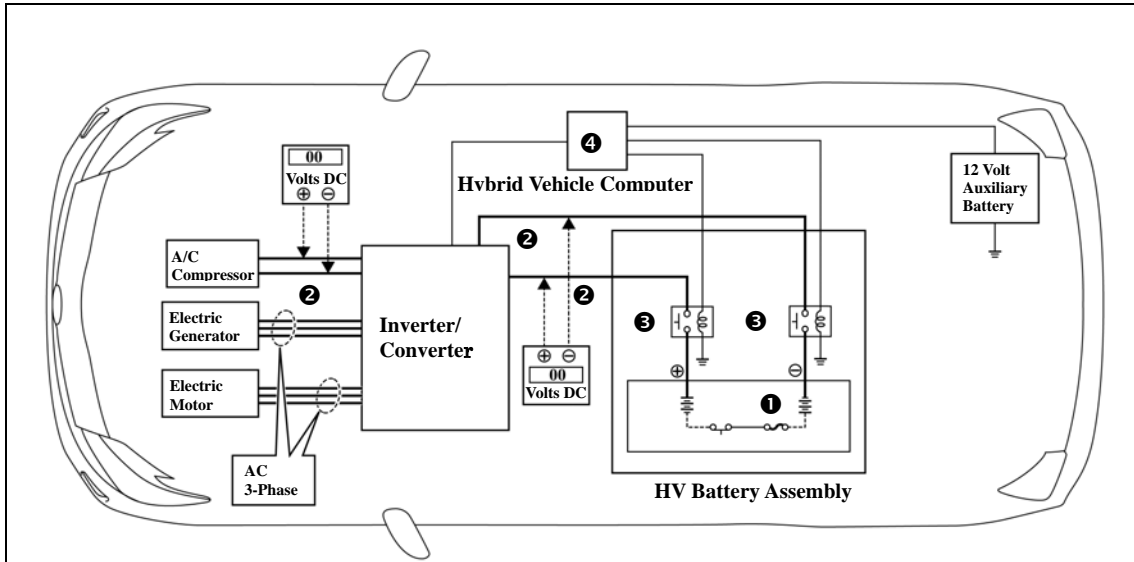

High Voltage Safety System – Vehicle Shut Off (**READY-OFF**)

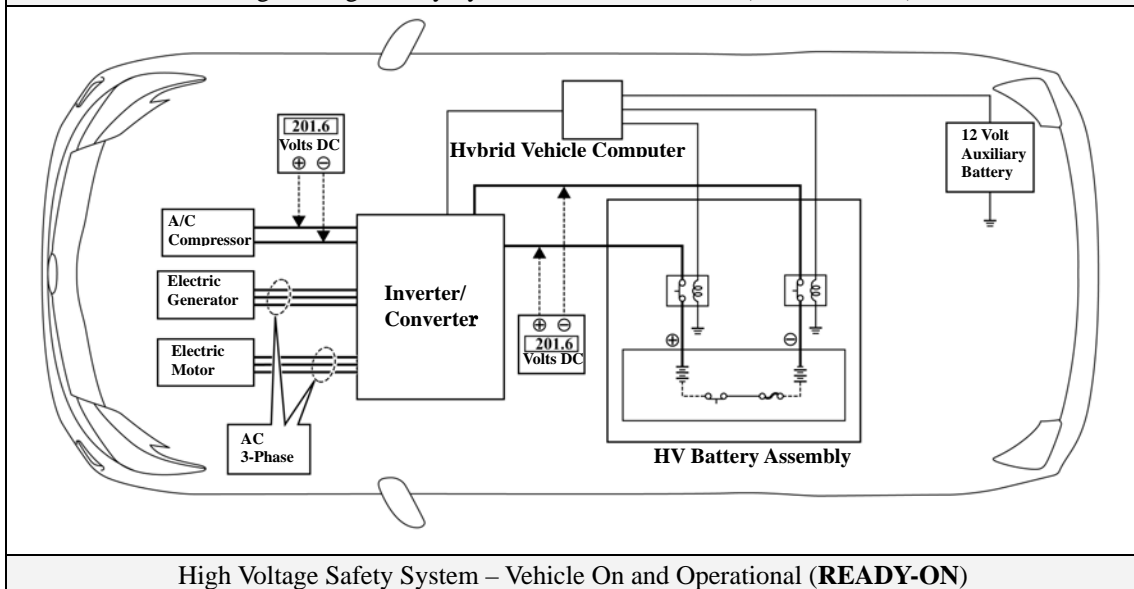

High Voltage Safety System – Vehicle On and Operational (**READY-ON**)

Precaution to be observed when dismantling the vehicle



WARNING:

- *The high voltage system may remain powered for up to 10 minutes after the vehicle is shut off or disabled. To prevent serious injury or death from severe burns or electric shock, avoid touching, cutting, or opening any orange high voltage power cable or high voltage component.*

Necessary Items

- Protective clothing such as insulated gloves (electrically insulated), rubber gloves, safety goggles, and safety shoes.
- Insulating tape such as electrical tape that has a suitable electrical insulation rating.
- Before wearing insulated gloves, make sure that they are not cracked, ruptured, torn, or damaged in any way. Do not wear wet insulated gloves.
- An electrical tester that is capable of measuring DC 750 Volts or more.

Spills

The PRIUS +/PRIUS v hybrid contains the same common automotive fluids used in other non-hybrid Toyota vehicles, with the exception of the Li-ion electrolyte used in the HV battery assembly. The electrolyte used in the Li-ion battery cells is a flammable organic electrolyte. The electrolyte is absorbed into the battery cell separators, even if the battery cells are crushed or cracked, it is unlikely that liquid electrolyte will leak. Any liquid electrolyte that leaks from a Li-ion battery cell quickly evaporates.

 **WARNING:**

- *The Li-ion battery contains organic electrolyte. Only a small amount may leak from the batteries which may irritate the eyes, nose, throat, and skin.*
- *Contact with the vapor produced by the electrolyte may irritate the nose and throat.*
- *To avoid injury by coming in contact with the electrolyte or vapor, wear personal protective equipment for organic electrolyte including SCBA or protective mask for organic gases.*

- Handle Li-ion electrolyte spills using the following Personal Protective Equipment (PPE):
 - Splash shield or safety goggles. Fold down helmet shields are not acceptable for electrolyte spills.
 - Rubber gloves or gloves suitable for organic solvents.
 - Apron suitable for organic solvents.
 - Rubber boots or boots suitable for organic solvents.
 - Protective mask for organic gases or SCBA.

Dismantling the vehicle

The following 2 pages contain general instructions for use when working on a PRIUS +/PRIUS v. Read these instructions before proceeding to the HV battery removal instructions on page 19.



WARNING:

- **The high voltage system may remain powered for up to 10 minutes after the vehicle is shut off or disabled. To prevent serious injury or death from severe burns or electric shock, avoid touching, cutting, or opening any orange high voltage power cable or any high voltage component.**

1. Shut off the ignition (**READY** indicator is off). Then disconnect the cable from the auxiliary battery negative (-) terminal.
 - (1) Remove the 3 deck boards.
 - (2) Remove the 2 auxiliary boxes.
 - (3) Disconnect the battery negative terminal.

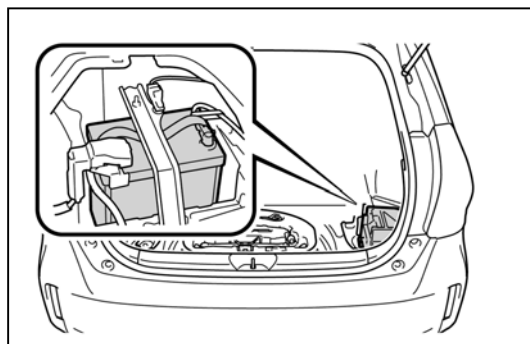

2. Remove the service plug cover.
 - (1) Remove the console cover.

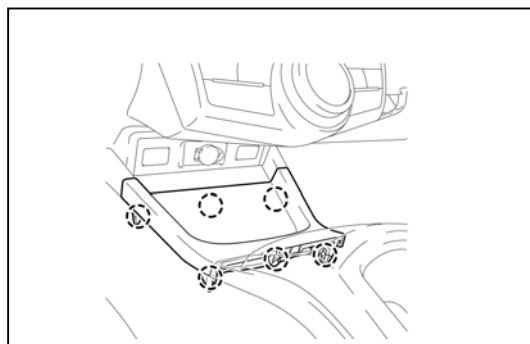

- (2) Remove the service plug cover.

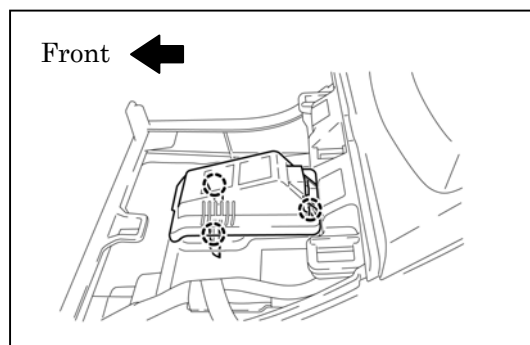

3. Remove the service plug grip.

Caution:

Wear insulated gloves for the following 4 steps.

- (1) Slide the handle of the service plug grip to the front.
- (2) Raise the release handle of the service plug grip
- (3) Remove the service plug grip.
- (4) Apply insulating tape to the socket of the service plug grip to insulate it.

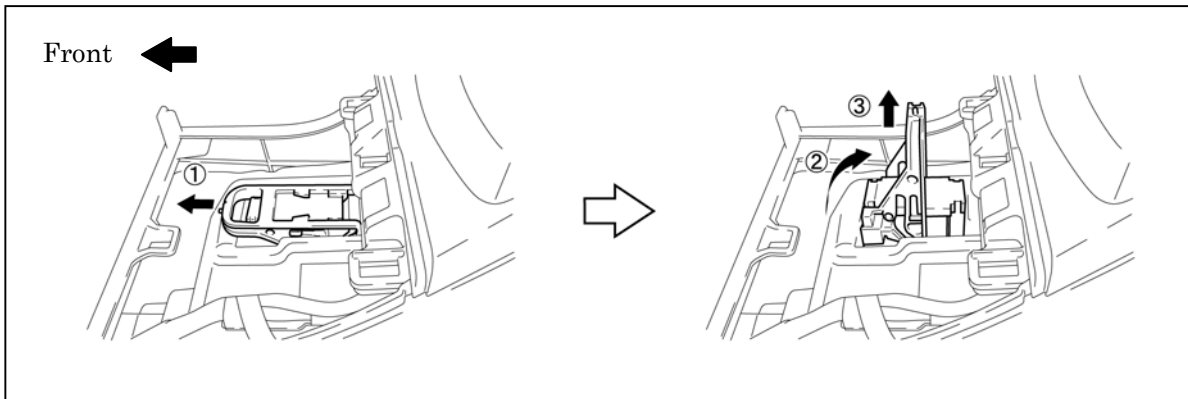

4. Carry the removed service plug grip in your pocket to prevent other staff from accidentally reinstalling it while you are dismantling the vehicle.
5. Make other staff aware that a high-voltage system is being dismantled by using the following sign: CAUTION: HIGH-VOLTAGE. DO NOT TOUCH (see page 18).
6. If the service plug grip cannot be removed due to damage to the vehicle, remove the **IG2** fuse (20 A).

Caution:

This operation shuts off the HV system. Be sure to wear insulated gloves because high voltage is not shut off inside the HV battery. When it is possible to remove the service plug grip, remove it and continue the procedure.

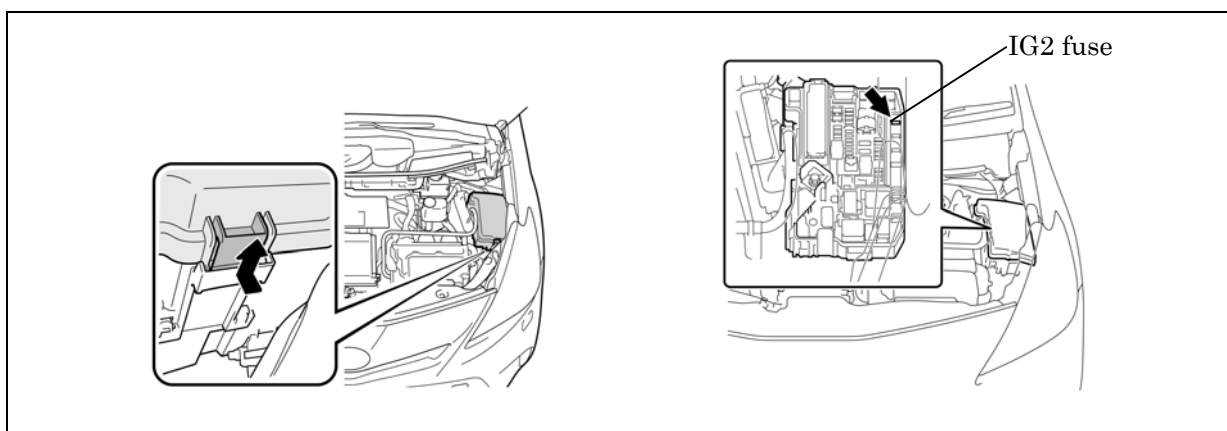

7. After disconnecting or exposing a high-voltage connector or terminal, insulate it immediately using insulating tape. Before disconnecting or touching a bare high-voltage terminal, wear insulated gloves.

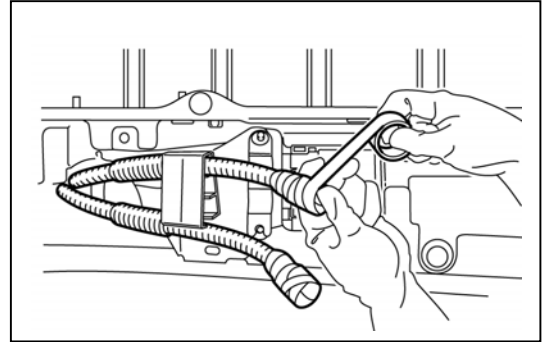

8. Check the HV battery and nearby area for leakage. If you find any liquid, it may be Li-ion electrolyte. Handle Li-ion electrolyte spills using the following Personal Protective Equipment (PPE):

- Splash shield or safety goggles. Fold down helmet shields are not acceptable for electrolyte spills.
- Rubber gloves or gloves suitable for organic solvents.
- Apron suitable for organic solvents.
- Rubber boots or boots suitable for organic solvents.
- Protective mask for organic gases or SCBA.

Caution:

- **The Li-ion battery contains organic electrolyte. Only a small amount may leak from the batteries which may irritate the eyes, nose, throat, and skin.**
 - **Contact with the vapor produced by the electrolyte may irritate the nose and throat.**
 - **To avoid injury by coming in contact with the electrolyte or vapor, wear personal protective equipment for organic electrolyte including SCBA or protective mask for organic gases.**
9. If the electrolyte comes into contact with your eye(s), call out loudly for help. Do not rub your eye(s). Instead, wash the eye(s) with a dilute boric acid solution or a large amount of water and seek medical care.
10. With the exception of the HV battery, remove parts by following procedures which are similar to conventional Toyota vehicles. For the removal of the HV battery, refer to the following pages.

Person in charge: _____

CAUTION:
HIGH-VOLTAGE.
DO NOT TOUCH.

CAUTION:
HIGH-VOLTAGE.
DO NOT TOUCH.

Person in charge: _____

When performing work on the HV system, fold this sign and
put it on the roof of the vehicle.

Removal of HV battery



WARNING:

- *Be sure to wear insulated gloves when handling high-voltage parts.*
- *Even if the vehicle is shut off and the relays are off, be sure to remove the service plug grip before performing any further work.*
- *Power remains in the high voltage electrical system for 10 minutes even after the HV battery assembly is shut off because the circuit has a condenser that stores power.*
- *Make sure that the tester reading is 0 V before touching any high-voltage terminals which are not insulated.*
- *The SRS may remain powered for up to 90 seconds after the vehicle is shut off or disabled. To prevent serious injury or death from unintentional SRS deployment, avoid cutting the SRS components.*

1. SHUT OFF IGINATION (**READY** indicator is off)
2. REMOVE 12 V AUXILIARY BATTERY

- (1) Remove the 3 deck boards.
- (2) Remove the 2 auxiliary boxes.

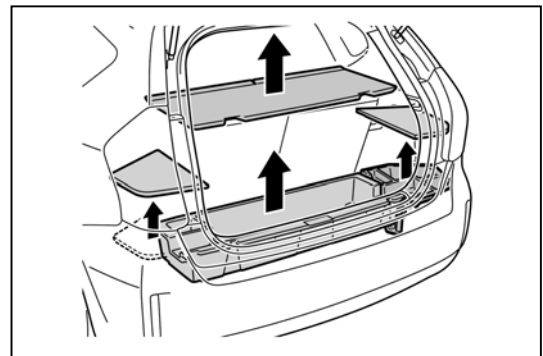

- (3) Disconnect the cable from the auxiliary battery negative (-) terminal.
- (4) Disconnect the cable from the auxiliary battery positive (+) terminal.
- (5) Remove the 12 Volt auxiliary battery.

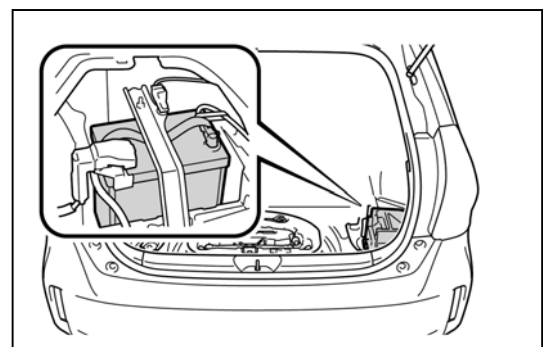

3. REMOVE SERVICE PLUG COVER

- (1) Remove the console cover.

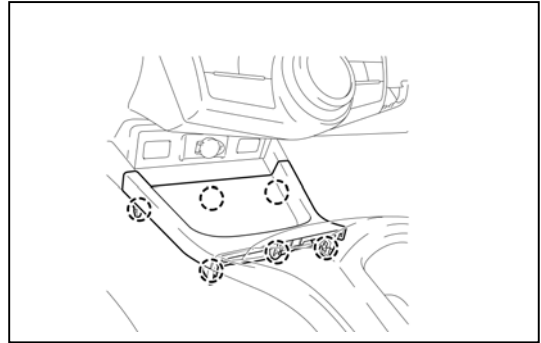

- (2) Remove the service plug cover.

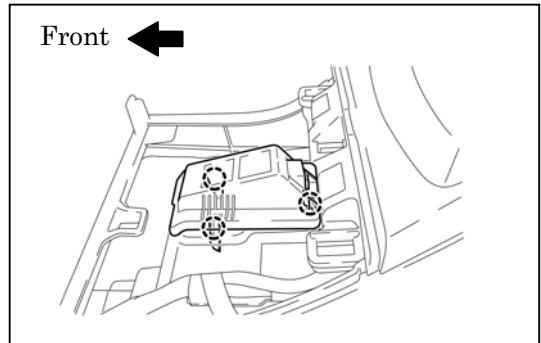

4. REMOVE SERVICE PLUG GRIP

Caution:

Wear insulated gloves for the following 4 steps.

- (1) Slide the handle of the service plug grip to the front.
- (2) Raise the release handle of the service plug grip
- (3) Remove the service plug grip.
- (4) Apply insulating tape to the socket of the service plug grip to insulate it.

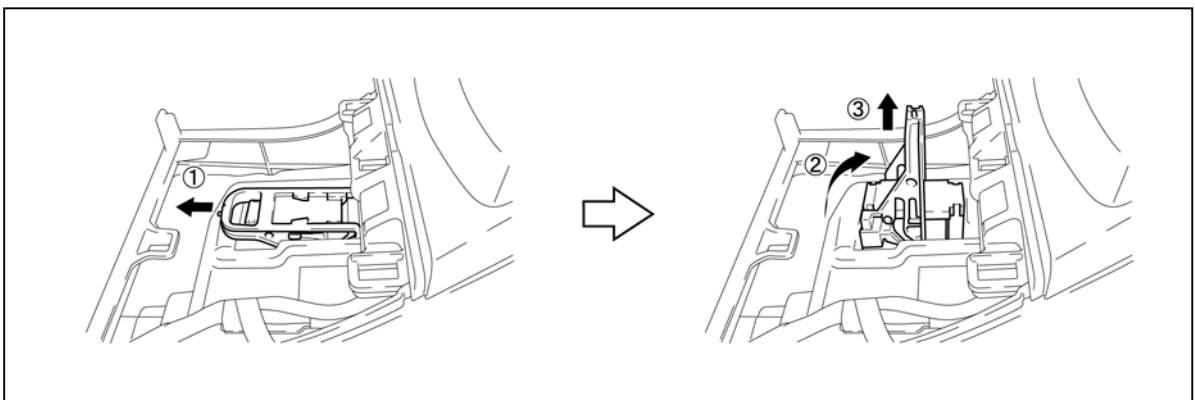

5. REMOVE 9 BOLTS AND INVERTER TERMINAL COVER

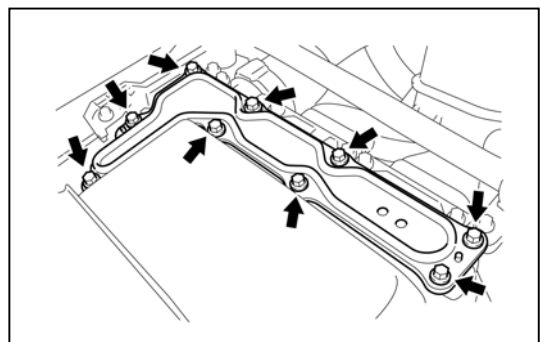

6. CHECK TERMINAL VOLTAGE

- (1) Check voltage at the terminals in inspection point in the power control unit.

Caution:

Wear insulated gloves.

To prevent serious injury or death, do not proceed with dismantling of the HV system until the voltage at the terminals in the inspection point is 0 V.

Standard voltage: 0 V

Hint:

Set the tester to DC 750 Volts measure the voltage.

This inspection is performed to verify that it is safe to remove the HV battery.

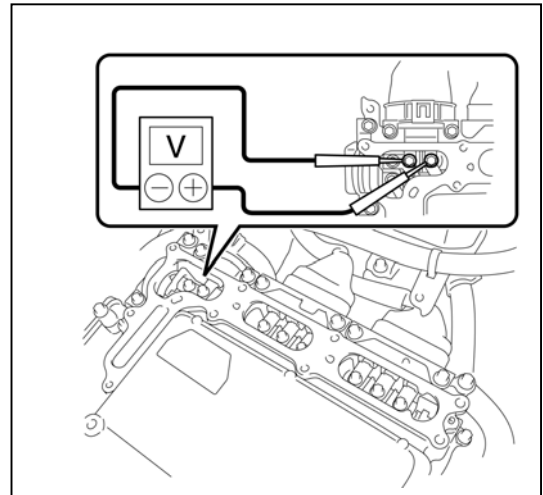

7. REMOVE FRONT SEAT HEADREST ASSEMBLY

8. REMOVE FRONT SEAT ASSEMBLY RH

- (1) Lift up the seat track adjusting handle and move the seat to the rearmost position.
- (2) Disengage the 2 claws and remove the front inner seat track bracket cover.

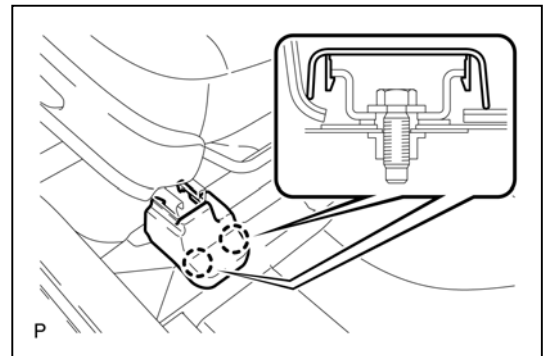

- (3) Disengage the 2 claws and remove the front outer seat track bracket cover.

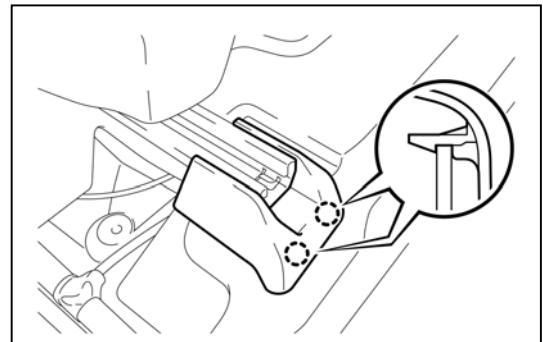

- (4) Lift up the seat track adjusting handle and move the seat to the foremost position.
- (5) Disengage the claw.
- (6) Disengage the guide and remove the rear inner seat track bracket cover.

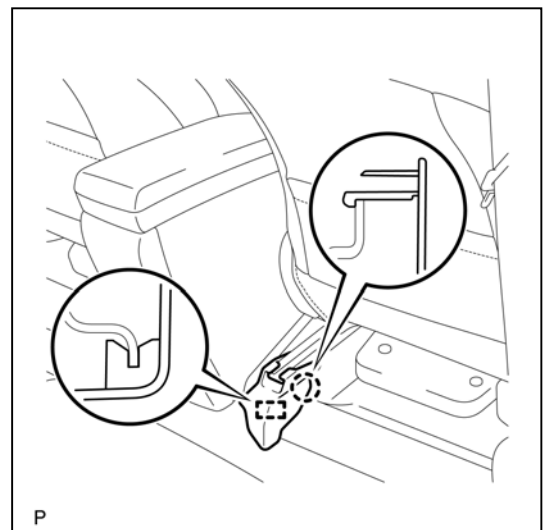

- (7) Disengage the 2 claws and remove the rear outer seat track bracket cover.

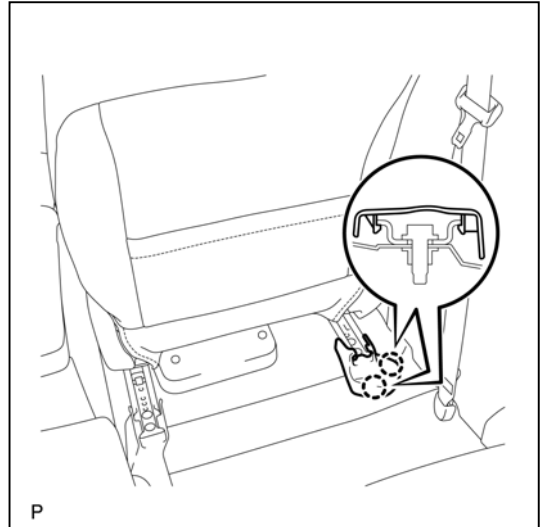

- (8) Remove the 2 bolts on the rear side of the seat.
(9) Lift up the seat track adjusting handle and move the seat to the rearmost position.

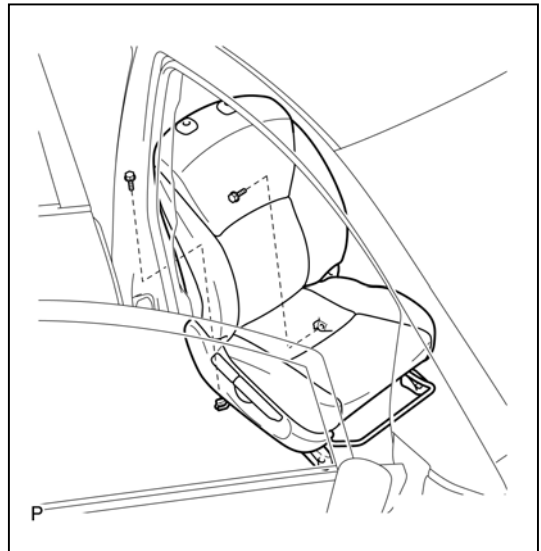

- (10) Remove the 2 bolts on the front side of the seat.
(11) Lift up the seat track adjusting handle and move the seat to the center position. Also, operate the reclining adjuster release handle and move the seatback to the upright position.
(12) Operate the vertical adjusting handle to move the seat cushion to the upper position.
(13) Disconnect each connector and clamp under the seat.
(14) Remove the front seat assembly.

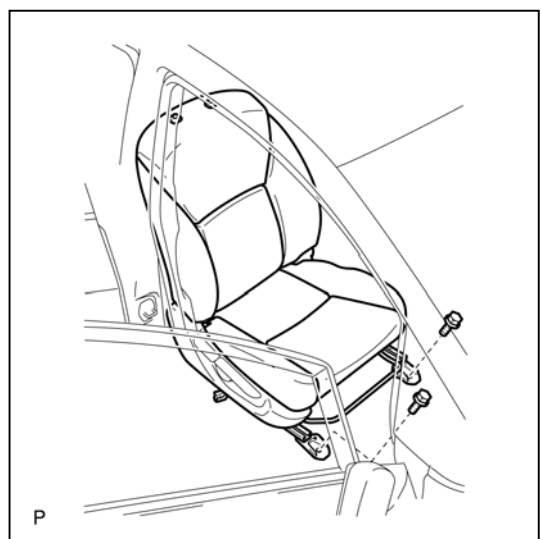

**9. REMOVE CENTER FLOOR CARPET COVER
LH**

- (1) Pull the front center floor carpet cover LH in the direction indicated by the arrow to disengage the 4 claws and guide, and remove the center floor carpet cover LH.

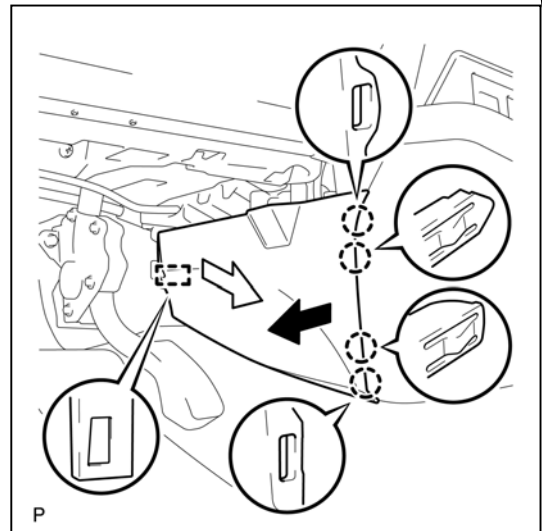

**10. REMOVE CENTER FLOOR CARPET COVER
RH**

- (1) Pull the front center floor carpet cover RH in the direction indicated by the arrow to disengage the 4 claws and guide, and remove the center floor carpet cover RH.

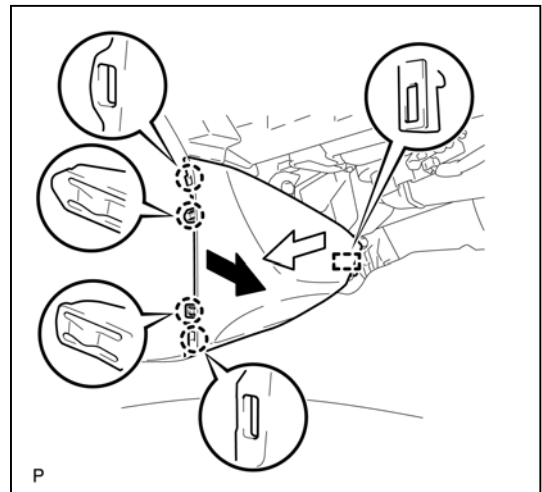

**11. REMOVE UPPER CONSOLE PANEL
SUB-ASSEMBLY**

- (1) Disengage the 7 claws.
- (2) Disconnect each connector and remove the upper console panel sub-assembly.

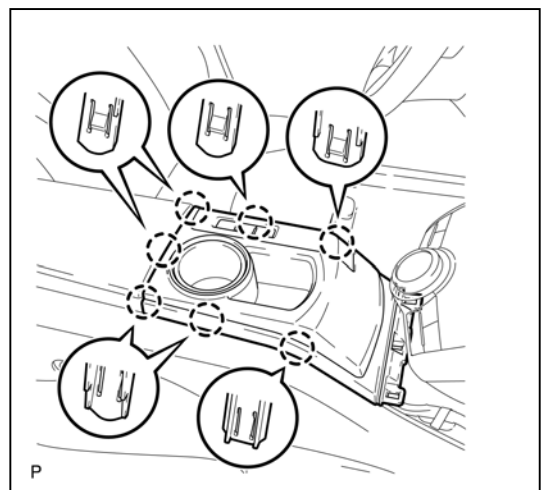

12. REMOVE FRONT NO. 2 CONSOLE BOX INSERT

- (1) Remove the front No. 2 console box insert.

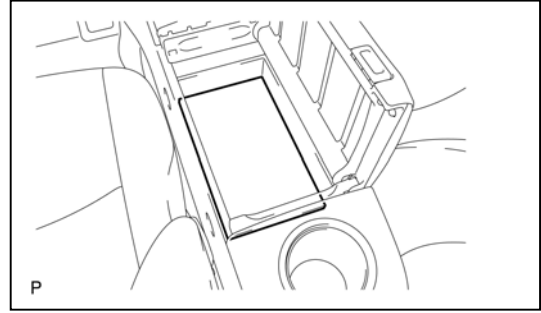

13. REMOVE CONSOLE BOX ASSEMBLY

- (1) Remove the 4 bolts and 6 clips.

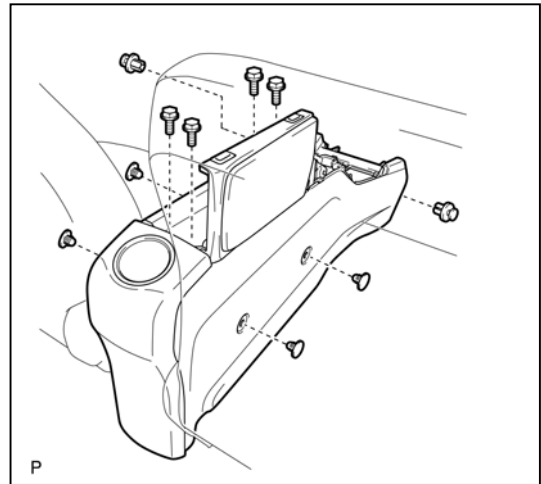

- (2) Disengage the clamp.
- (3) Pull the console box assembly in the direction indicated by the arrow to disengage the 4 claws and remove the console box assembly.

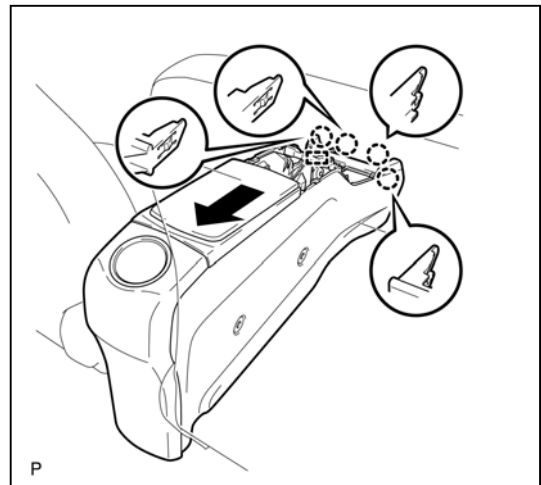

14. REMOVE NO. 1 HYBRID BATTERY SHIELD SUB-ASSEMBLY

Caution:
Wear insulated gloves for the following 3 steps.

- (1) Disconnect the 3 clamps.

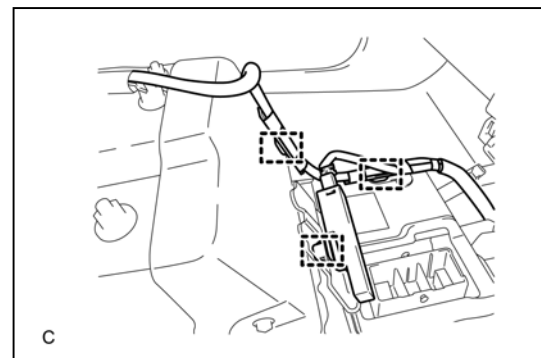

- (2) Remove the 4 bolts and No. 1 hybrid battery shield sub-assembly.

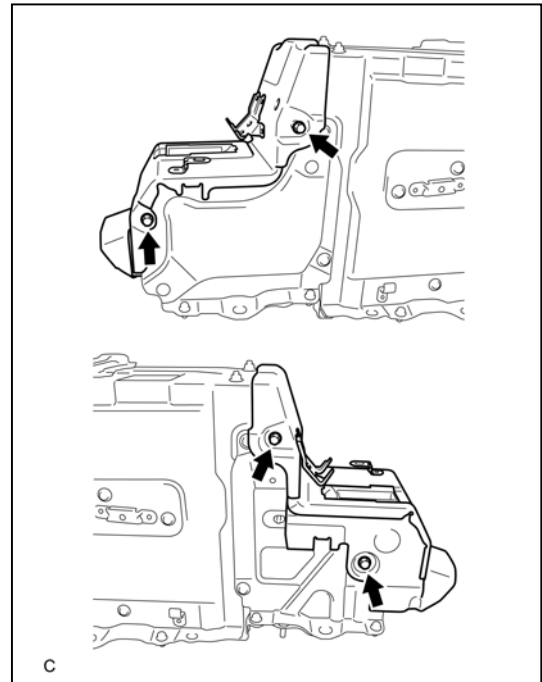

- (3) Disconnect the 4 connectors from the battery smart unit.

Notice:

Insulate the terminals of the removed frame wire with insulating tape.

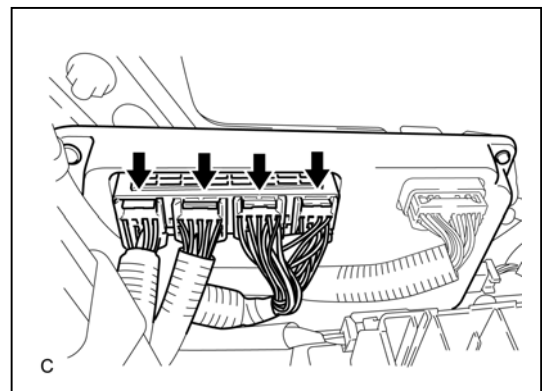

15. REMOVE FRAME WIRE

Caution:

Wear insulated gloves for the following 2 steps.

Notice:

Insulate the terminals of the removed frame wire with insulating tape.

- (1) Using an insulated tool, remove the 3 nuts and disconnect the frame wire from the hybrid battery junction block assembly.

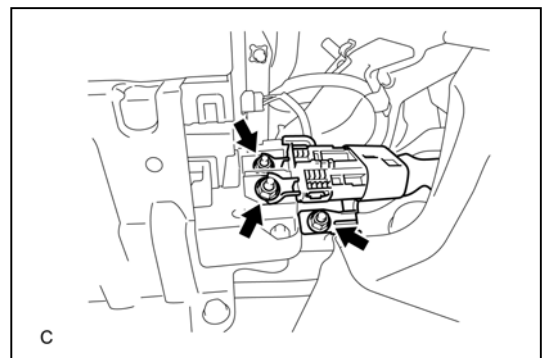

(2) Install the frame wire as shown in the illustration.

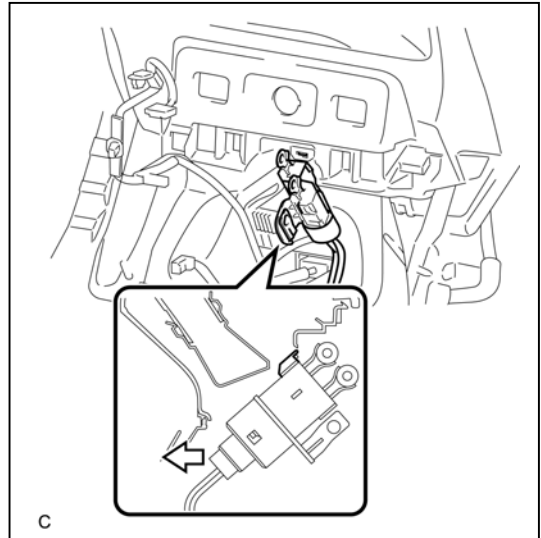

16. REMOVE NO. 1 HYBRID BATTERY EXHAUST DUCT

(1) Remove the 2 clips and No. 1 hybrid battery exhaust duct.

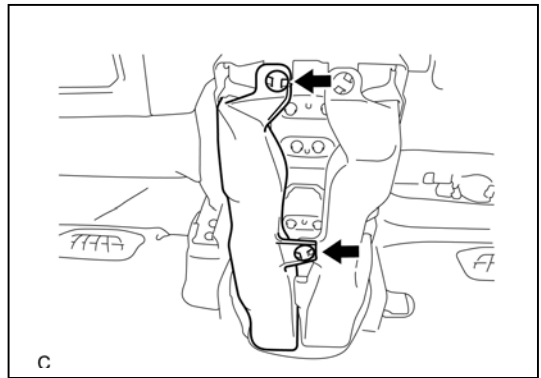

17. REMOVE NO. 4 HYBRID BATTERY INTAKE DUCT

(1) Remove the 2 clips and No. 4 hybrid battery intake duct.

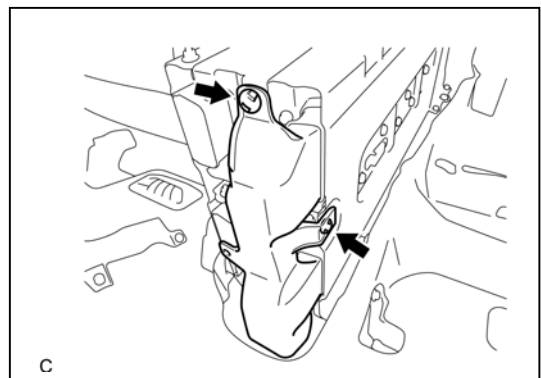

19. REMOVE HV BATTERY ASSEMBLY

Caution:

Wear insulated gloves.

Notice:

- Insulate the removed connectors and terminals with insulating tape.
- Since the HV battery assembly is very heavy, 2 people are needed to remove the HV battery assembly. When removing the HV battery assembly, do not damage the parts around it.
- When moving the hybrid battery, make sure to use an engine lifter.

- (1) Disconnect the 2 connectors.
- (2) Disconnect the floor carpet from the HV battery assembly.

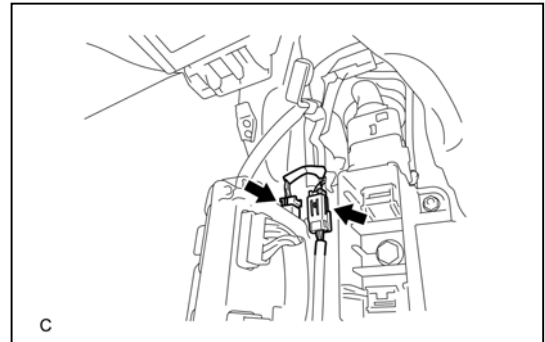

- (3) Remove the 6 bolts.

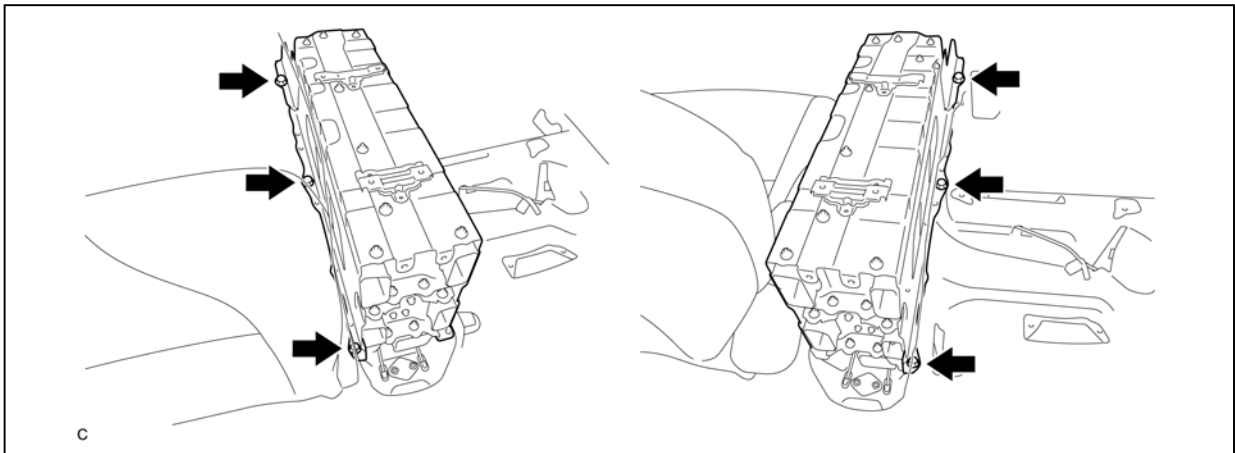

- (4) Remove the HV battery assembly.

Hint:

Be sure to place the HV battery on the attachment to prevent the guide pins from being damaged.

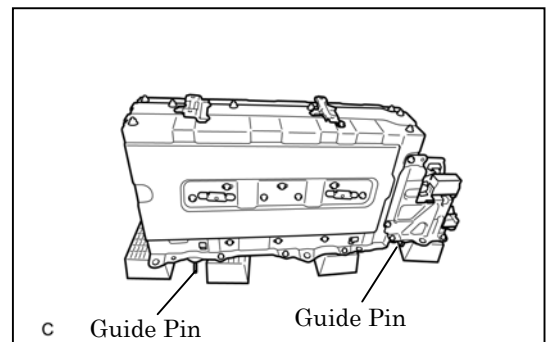



20. HV BATTERY ASSEMBLY RECYCLING

- (1) The HV battery assembly is recyclable. Contact your Toyota distributor (if included on the HV battery caution label) or contact the nearest Toyota dealer (see below for samples of the HV battery caution label).

Caution:

After removing the HV battery, do not reinstall the service plug grip to the HV battery.

HV Battery Caution Label

	 DANGER	High Voltage Parts Inside / Contains Organic Electrolyte		Pièces à haute tension / Contient de l'électrolyte organique			
		<p>Failure to observe the following may result in fire, electrical shock, or, in the worst case, may result in death. Leakage of organic electrolyte from this battery unit may cause blindness or skin problems if the electrolyte comes into contact with the eyes, skin or clothes. In case of accidental contact, rinse the affected area with a large quantity of water and seek medical attention immediately.</p> <p>● Never attempt to remove, disassemble, or modify this unit or use it for other than its intended purpose. (Please have your dealer or a qualified technician handle the battery.)</p> <p>● Do not dispose of this unit illegally; it may result in pollution or in serious injury due to a third party touching the unit.</p> <p>● Do not subject this unit to physical impact that may cause damage. ● Keep this unit away from fire. ● Do not pour water on this unit. ● Keep children away from this unit.</p>		<p>Le non-respect de ces mesures peut provoquer un incendie ou une décharge électrique, voire entraîner la mort dans les cas les plus graves. Une fuite d'électrolyte organique au niveau de cette batterie peut entraîner la cécité ou des problèmes dermatologiques si l'électrolyte entre en contact avec les yeux, la peau ou les vêtements. En cas de contact accidentel, rincez abondamment la zone touchée avec de l'eau et consultez immédiatement un médecin. ● Ne jamais essayer de déposer, démonter ou modifier cette batterie, ou de l'utiliser à d'autres fins que celles initialement prévues. (Demander à votre concessionnaire ou à un technicien qualifié de manipuler la batterie.) ● Ne pas jeter cette batterie de manière illégale. Cela pourrait polluer l'environnement ou provoquer de graves blessures si des personnes venaient à toucher la batterie. ● Ne pas exposer cette batterie à des chocs physiques susceptibles de l'endommager. ● Tenir cette batterie éloignée du feu. ● Ne pas verser d'eau sur cette batterie. ● Garder hors de portée des enfants.</p>			<p>47060</p>
To Qualified (EV or HV) Technicians Be sure to read the Repair Manual when servicing or replacing this unit. Please perform battery diagnostics to correct ECU data after replacing this battery.		To Haulers and Dismantlers Please consult with your dealer or your national distributor when hauling or dismantling this unit.		A l'attention des techniciens qualifiés en EV ou HV Veuillez à lire le manuel de réparation lors de l'entretien ou du remplacement de cette batterie. Après le remplacement de cette batterie, veuillez à effectuer des diagnostics de la batterie afin de corriger les données de l'ECU.		A l'attention des transporteurs et des démonteurs Veuillez à consulter votre concessionnaire ou votre distributeur national lorsque vous transportez ou démontez cette batterie.	
Li-ion							
HV Battery Recycling Information : Please transport this unit in accordance with all applicable laws. Please contact your nearest dealer or national distributor for inquiries or to request disposal of this unit.							
Informations concernant le recyclage des batteries des HV : Veuillez à transporter cette batterie dans le respect des lois applicables. Contacter le concessionnaire ou le distributeur national le plus proche si vous avez des questions ou souhaitez demander la mise au rebut de cette batterie.							