



Auris

Toyota Parking Aid 400

Installation instructions

Model year: 2007
Vehicle code: **E15**-*G***W or **E15**-*H***W

Part number: Main Kit: PZ464-T0421-00
Sensor Kit: PZ464-00420-**
Switch (optional): PZ464-00420-55

 Weight: Main Kit 1,9 kg Sensor Kit 0,1 kg

 Installation time: 1.9 hour

Manual reference number: AIM 000 779-1

Revision Record

Rev. No.	Date	Page	Picture	Update	New	Deleted Steps
1	9-02-07	9	5	X		
		10	8		X	
		11	11-12		X	
		17	29		X	
		19	31		X	

GB

- Expert Fitment Required.
- Disconnect the battery earth cable.
- To avoid damage to the wiring harness, ensure contact with sharp edges is prevented.
- Install parts as shown on illustrations.
- Re-connect battery.
- Re-fit panels, ensure that the wiring harness and other components are neatly and securely located.

D

- Montage durch Fachwerkstatt erforderlich.
- Massekabel von Batterie abklemmen.
- Zur Vermeidung von Beschädigungen an der Kabelisolation ist Berührung mit scharfen Kanten zu vermeiden.
- Teile gemäß Abbildung montieren.
- Batterie wieder anschließen.
- Paneele wieder anbringen; achten Sie darauf, daß der Kabelbaum und andere Teile ordnungsgemäß und genau positioniert sind.

E

- Montaje sólo por el concesionario.
- Desconectar el cable de masa de la batería.
- A efectos de evitar desperfectos en el aislamiento del cable, hay que evitar el contacto con aristas cortantes.
- Montar las piezas tal como se indica en las figuras.
- Vuelva a conectar la batería.
- Volver a colocar los paneles; preste atención a que el mazo del cable y las demás piezas tengan la posición correcta y precisa.

F

- Montage par spécialiste nécessaire.
- Débrancher le câble de masse de la batterie.
- Eviter tout contact avec des arêtes vives afin de ne pas endommager l'isolation des câbles.
- Monter les pièces selon les figures.
- Reconnecter la batterie.
- Remettre le panneau; veillez à ce que le faisceau et les autres pièces soient positionnés correctement et avec la précision requise.

I

- E' necessario in officina specializzata.
- Staccare il cavo di massa dalla batteria
- Allo scopo di evitare danni all'isolazione dei cavi, evitare di metterli a contatto con spigoli acuti.
- Montare le parti secondo quanto rilevabile delle illustrazioni.
- Riconnettere la batteria.
- Rimettere in posizione i pannelli; far ben attenzione che il fascio di cavi e le altre parti siano state posizionate con esattezza e nella dovuta maniera.

P

- Especialista em montagem requerido.
- Separe o cabo de terra do acumulador.
- Para não se danificar a isolação dos cabos, é conveniente evitar-se contacto com arestas afiadas.
- Monte as partes conforme ilustrado.
- Recolocar a bateria
- Tornar a colocar os painéis; verificar se a árvore de cabos e outras peças estão na posição exacta e prescrita.

NL

- Montage door vakman nodig.
- Massakabel van accu losmaken.
- Ter vermindering van beschadiging aan de isolatie van de elektrokit dient contact met scherpe kanten te worden vermeden.
- Delen overeenkomstig afbeelding monteren.
- Accu weer aansluiten.
- Panelen weer monteren; let erop, dat de kabelboom en andere delen correct en netjes gepositioneerd worden.

DK

- Montage ved professionelt værksted påkrævet.
- Stelkabel fjernes fra batteri.
- Berøring med skarpe kanter skal undgås for at undgå beskadigelse af kabelisoleringen.
- Dele skal monteres i henhold til illustrationer.
- Tilslut batteri igen.
- Paneler fastgøres igen; vær opmærksom på, at kabelsamlingen og andre dele placeres korrekt og præcist.

N

- Nødvendig med montering fra fagvevverksted.
- Kløm jordkabelen av batteriet.
- For å unngå skader på kabelisoleringen må berøring av skarpe kanter unngås.
- Monter alle deler i henhold til illustrasjonene.
- Tilkobl batteriet igjen.
- Monter panelene igjen, og pass på at kabelbunten og andre deler er anbrakt ordentlig og på riktig sted.

S

- Verkstadsmontage erfordras.
- Lossa stomkabeln från batteriet.
- För att förhindra skador på ledningarnas isolation skall beröring med vassa kanter undvikas.
- Montera detaljerna enligt figurerna
- Anslut batteriet igen.
- Sätt tillbaka panelerna igen; kontrollera noga att ledningsmattan och andra detaljer ligger på rätt plats.

FIN

- Asennus tarpeen merkkikorjaamossa.
- Erotta maadoitusjohto akusta
- Pidä huoli myös siitä, että kaapelointi on korin kiinnityksen myötäinen ja kiinnitetty huolellisesti muihin liikkuviin osiin.
- Asenna osat kuvien mukaan.
- Kytke akku takaisin.
- Aseta paneelit paikalleen; tarkista, että kaapelointi ja muut osat ovat asianmukaisesti ja tarkalleen paikoillaan.

CZ

- Montáž ve specializované dílně nutná.
- Odpojte zemnicí kabel od baterie.
- Zabraňte tomu, aby se kabely poškodily tím, že jsou položeny na ostrých hranách.
- Montujte části podle vyobrazení
- Opět připojit baterii.
- Opět připevněte panely; dbejte na to, aby svazek kabelů a ostatní části byly uloženy na správném místě.

H

- A szereléshez szakmúhely kell.
- Húzza le az akkumulátor testkábeljét.
- A kábelszigetelés megsérülésének elkerülésére ügyeljen arra, hogy a kábel ne juthasson érintkezésbe éles peremű alkatrészekkel.
- Az alkatrészeket az ábrák szerint szerelje be.
- Ismét csatlakoztassa az akkumulátort.
- Szerelje vissza a fedőlapokat, ügyeljen arra, hogy a kábelek és a többi alkatrész pontosan a számkra kijelölt helyen maradjanak.

PL

- Konieczny montaż przez warsztat specjalistyczny.
- Odłączyć przewód masy od akumulatora.
- Dla zapobieżenia uszkodzeniu izolacji chronić przed zetknięciem z ostrymi krawędziami.
- Zamontować części zgodnie z rysunkiem.
- Ponownie podłączyć akumulator.
- Na powrót osadzić osłony; zadbać aby wiązka kablowa i inne części były właściwie i dokładnie ułożone.

GR

- Να τοποθετεί από συνεργείο.
- Αποσυνδέστε το καλώδιο γείωσης από τη μπαταρία.
- Για να αποφευχθούν ζημιές στη μόνωση καλωδίων, να αποφεύγεται η επαφή των με αιχμηρές ακμές.
- Τοποθέτηση των μερών σύμφωνα με τις Εικόνες.
- Συνδέστε πάλι τη μπαταρία.
- Τοποθετήστε πάλι το κάλυμμα· προσοχή, η πλεξούδα καλωδίων και άλλα μέρη να είναι τοποθετημένα ακριβώς και σύμφωνα με τους κανονισμούς.

RUS

- Монтаж должны выполнять специалисты в мастерской
- Отсоединить заземляющий кабель аккумулятора
- Во избежание повреждений изоляции кабеля не допускать соприкосновения с острыми углами
- Монтировать части согласно иллюстрации
- Снова подключить аккумулятор
- Установить панель, проверить правильность и точность расположения кабелей и других частей







TR

- Uzmanın takması gereklidir .
- Akü toprak kablosunu ayırın.
- Kablo demetinin hasar görmemesi için, sivri objelerle temasın engellenmesini sağlayın.
- Parçaları çizimlerde gösterildiği gibi takın.
- Aküyü tekrar bağlayın.
- Panoları tekrar takın, kablo demeti ve diğer komponentlerin tam ve sıkıca yerleşmesini sağlayın.

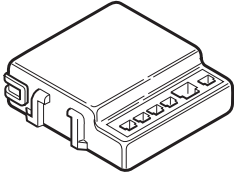
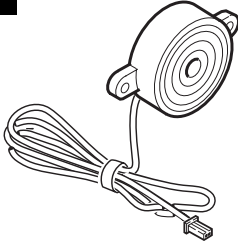
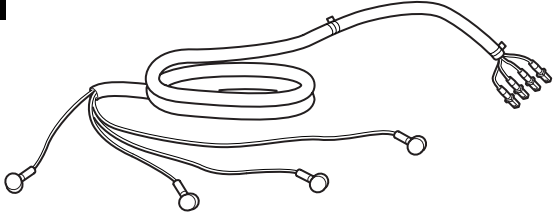
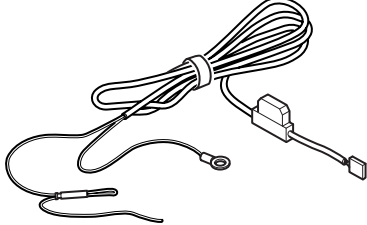
	GB	D	E	F	I	P	NL	DK
L	Blue	Blau	Azul	Bleu	Blu	Azul	Blauw	Blå
B	Black	Schwarz	Negro	Noir	Nero	Preto	Zwart	Sort
BR	Brown	Braun	Marrón	Marron	Marrone	Castanho	Bruin	Brun
G	Green	Grün	Verde	Vert	Verde	Verde	Groen	Grøn
GR	Grey	Grau	Gris	Gris	Grigio	Cinzeno	Grijs	Grå
NO	Natural colour	Naturfarben	Color natural	Nature	Colori naturali	Cores naturais	Naturel	Naturfarvet
O	Orange	Orange	Naranja	Orange	Arancione	Laranja	Oranje	Orange
P	Pink	Rosa	Rosa	Rose	Rosa	Rosa	Rosé	Rosa
R	Red	Rot	Rojo	Rouge	Rosso	Vermelho	Rood	Rød
W	White	Weiß	Blanco	Blanc	Bianco	Branco	Wit	Hvid
Y	Yellow	Gelb	Amarillo	Jaune	Giallo	Amarelo	Geel	Gul
V	Violet	Violett	Violeta	Violet	Viola	Violeta	Violet	Violet

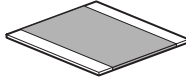

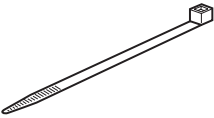
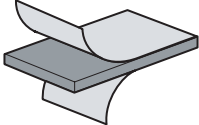
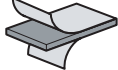
	N	S	SF	CZ	H	PL	GR
L	Blå	Blå	Sininen	Modrá	Kék	Niebieska	Μπλε
B	Sort	Svart	Musta	Černá	Fekete	Czarna	Μαύρο
BR	Brun	Brun	Ruskea	Hnědá	Barna	Brazowa	Καφέ
G	Grønn	Grøn	Vihreä	Zelená	Zöld	Zielona	Πράσινο
GR	Grå	Grå	Harmaa	Šedá	Szürke	Szara	Γκρι
NO	Naturfarger	Naturfärger	Luonnonväri	Přírodní barva	Természetes színű	Barwy naturalne	Φυσικά χρώματα
O	Orange	Orange	Oranssi	Oranžová	Narancs	Pomarańczowa	Πορτοκαλί
P	Rosa	Rosa	Rosa	Růžová	Rózsaszín	Różowa	Ροζ
R	Rød	Röd	Punainen	Červená	Piros	Czerwona	Κόκκινο
W	Hvit	Vit	Valkoinen	Bílá	Fehér	Biała	Λευκό
Y	Gul	Gul	Keltainen	Žlutá	Sárga	Żółta	Κίτρινο
V	Fiolett	Violett	Violetti	Fialová	Ibolyakék	Fioletowa	Μοβ







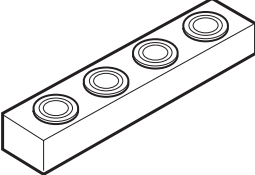

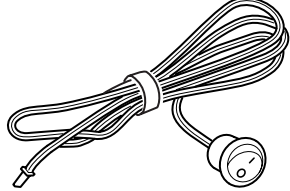

	RUS	TR
L	Синий	Mavi
B	Черный	Siyah
BR	Коричневый	Kahverengi
G	Зеленый	Yeşil
GR	Серый	Gri
NO	Естественный цвет	Nötr
O	Оранжевый	Turuncu
P	Розовый	Pembe
R	Красный	Kırmızı
W	Белый	Beyaz
Y	Желтый	Sarı
V	Фиолетовый	Mor

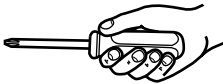
<p>A</p>  <p>1x</p>	<p>B</p>  <p>1x</p>	<p>C</p>  <p>1x</p>		
<p>D</p>  <p>1x</p>	<p>E</p>  <p>1x</p>	<p>F</p> <p>FOAM</p>  <p>1x</p>	<p>G</p>  <p>8x</p>	
<p>H</p>  <p>15x</p>	<p>I</p>  <p>1x</p>	<p>J</p>  <p>1x</p>	<p>K</p>  <p>5x</p>	<p>L</p>  <p>1x</p>

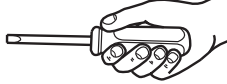
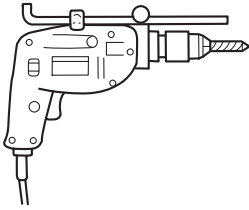
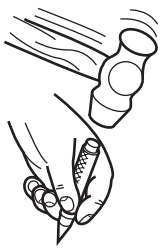
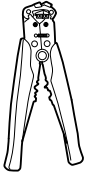
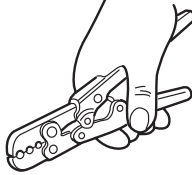
PZ464-00420-**

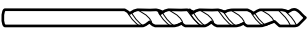
PZ464-00420-55

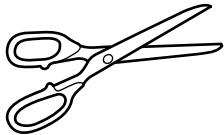
<p>M</p>  <p>1x</p>	<p>N</p>  <p>Only PZ464-00420-AB</p> <p>4x</p>	<p>O</p>  <p>1x</p>
---	--	---

	 	 	
	 <p>Würth Art. No. 0557 900 445</p>	 <p>Würth Art. No. 0558130</p>	
 <p>Ø 2 mm Ø 20 mm</p>	 <p>CLEAN</p>		

Only PZ464-00420-AB

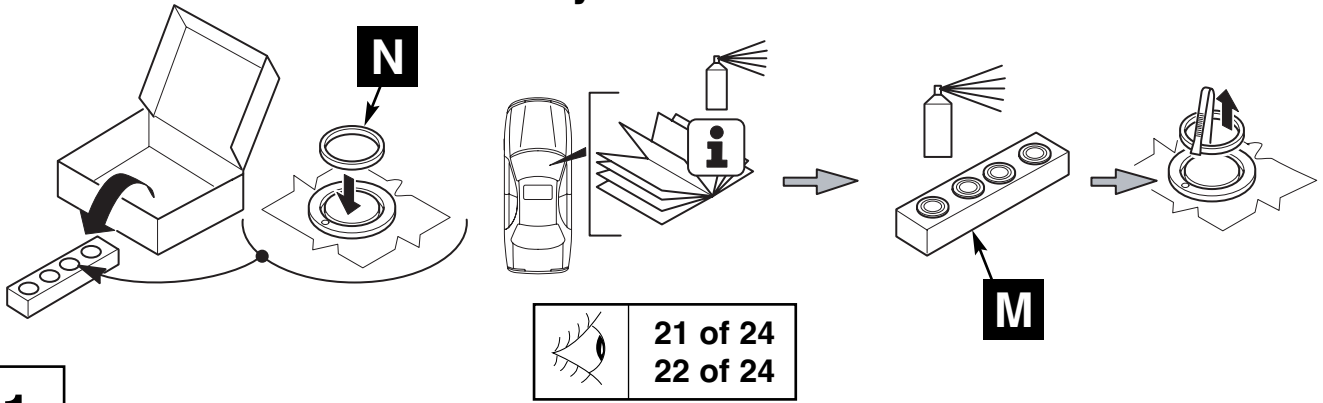

1

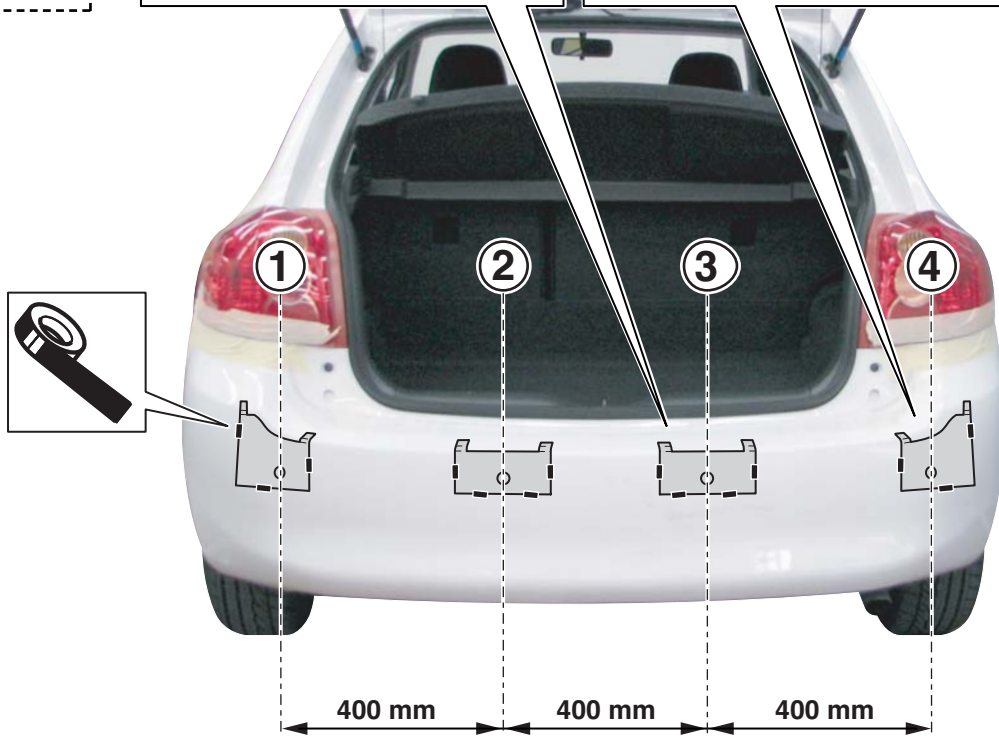
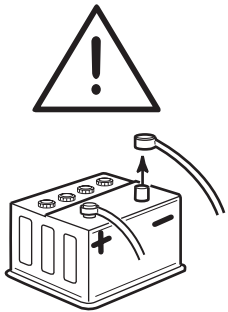

2

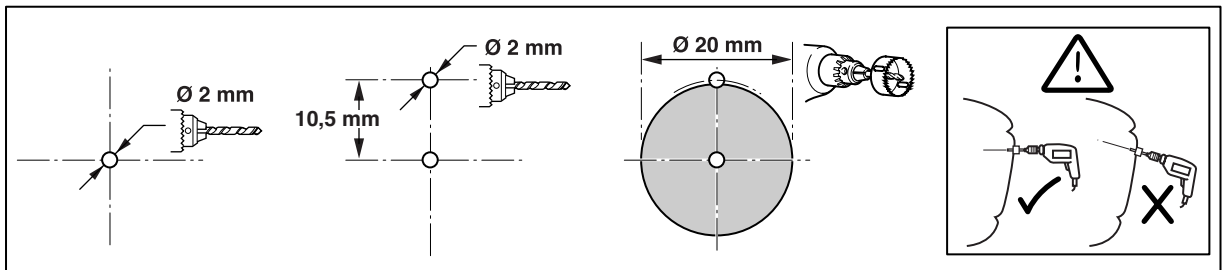



3

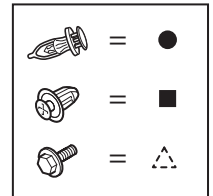

4



5 dr

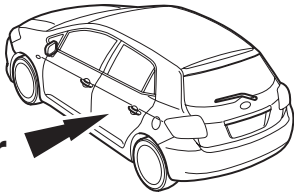

1 ... 11



3 dr

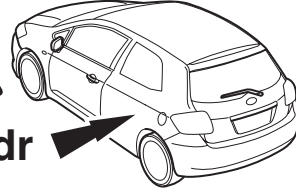

1 ... 10

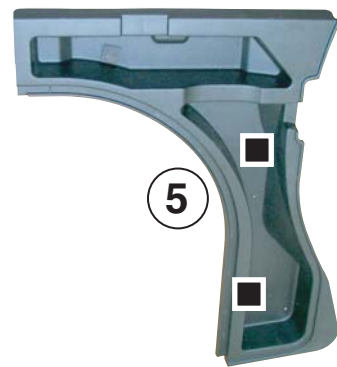
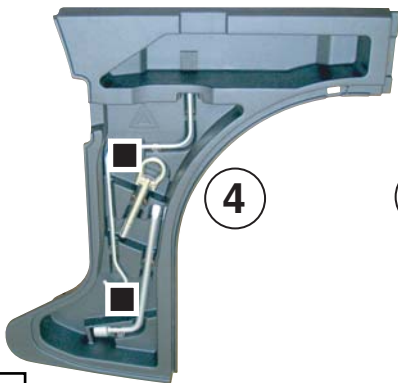
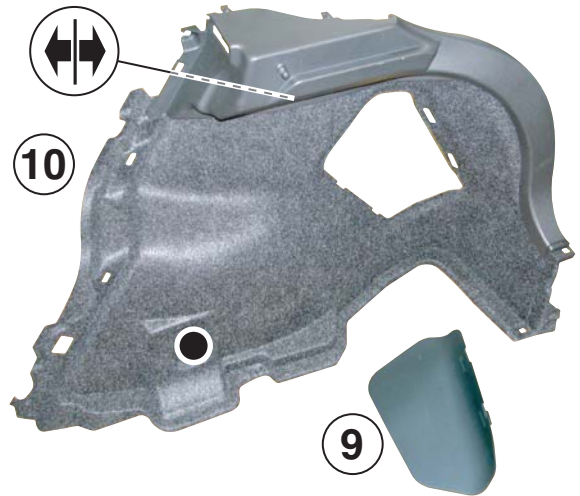
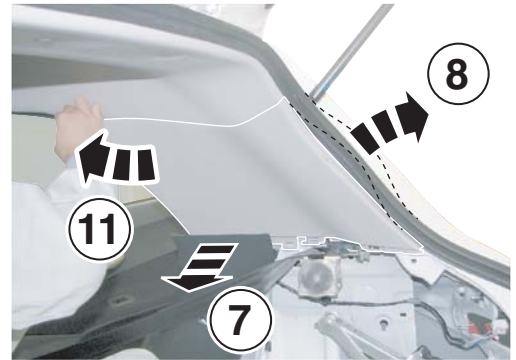
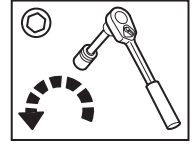
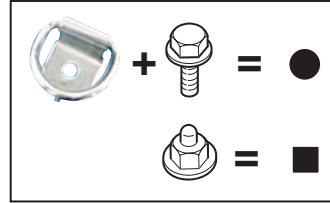

5

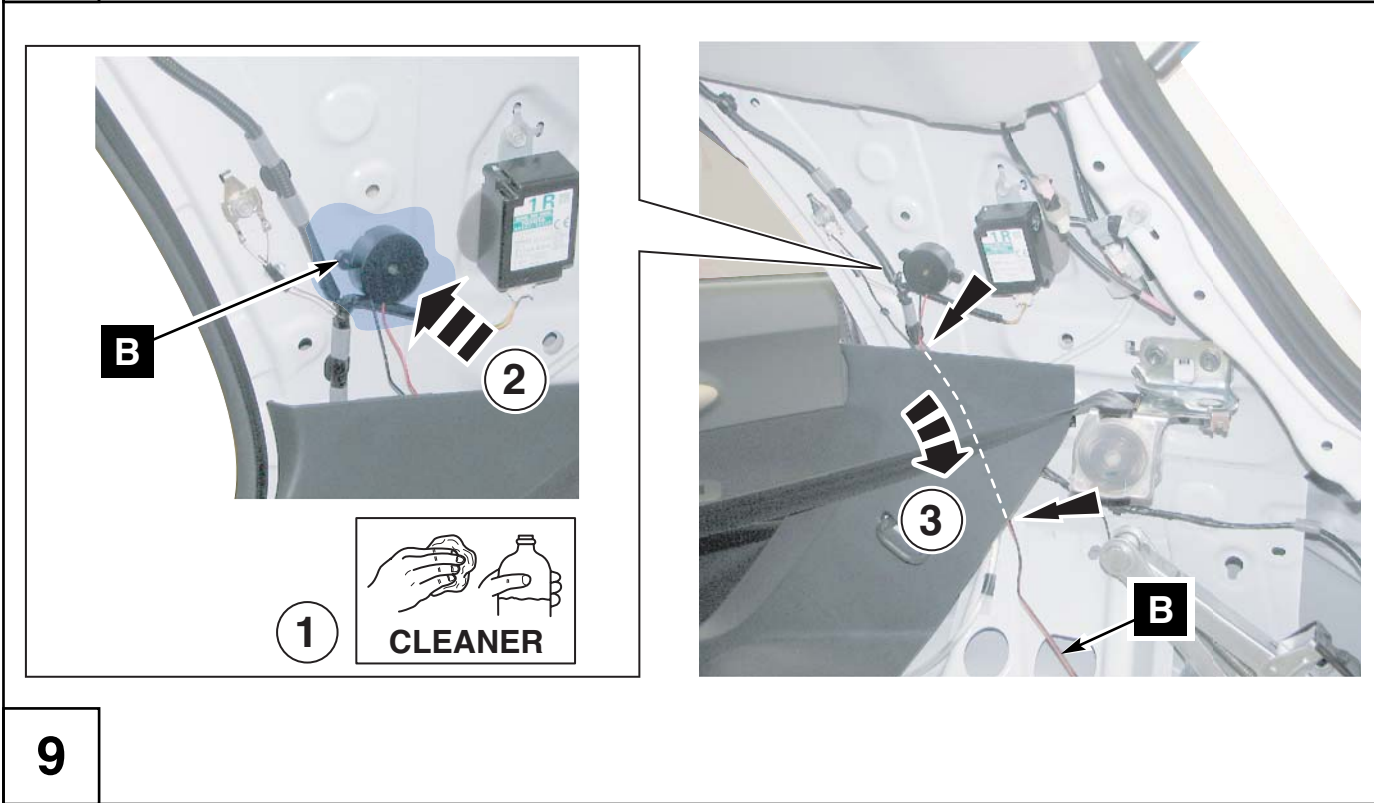
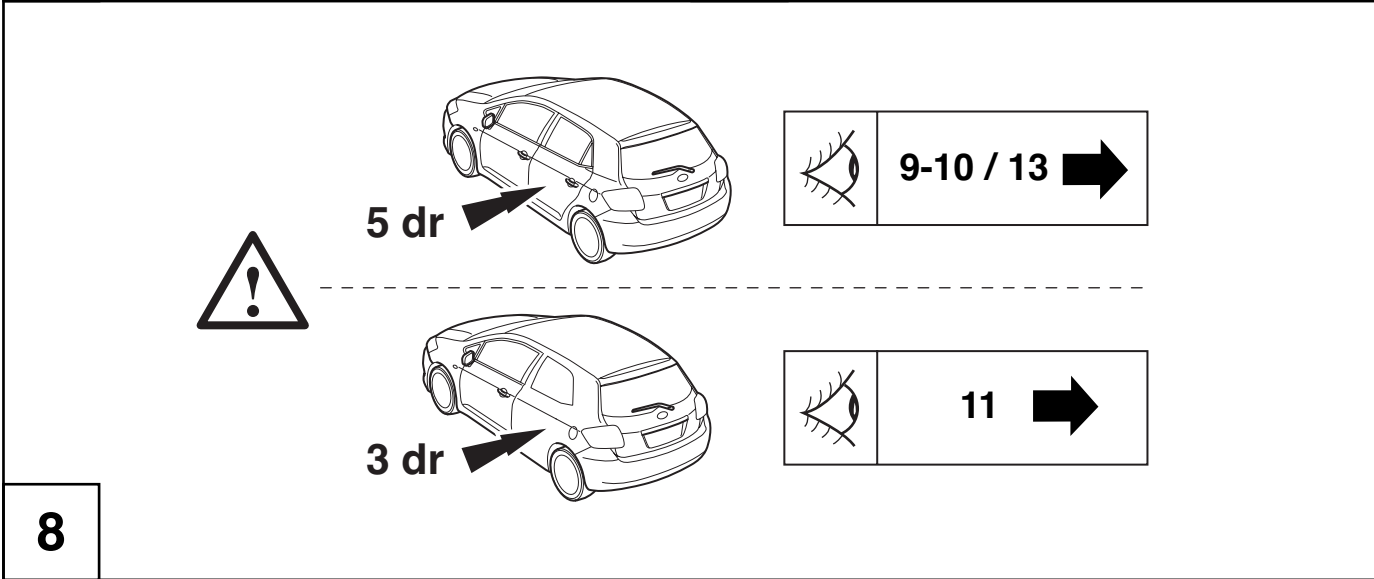
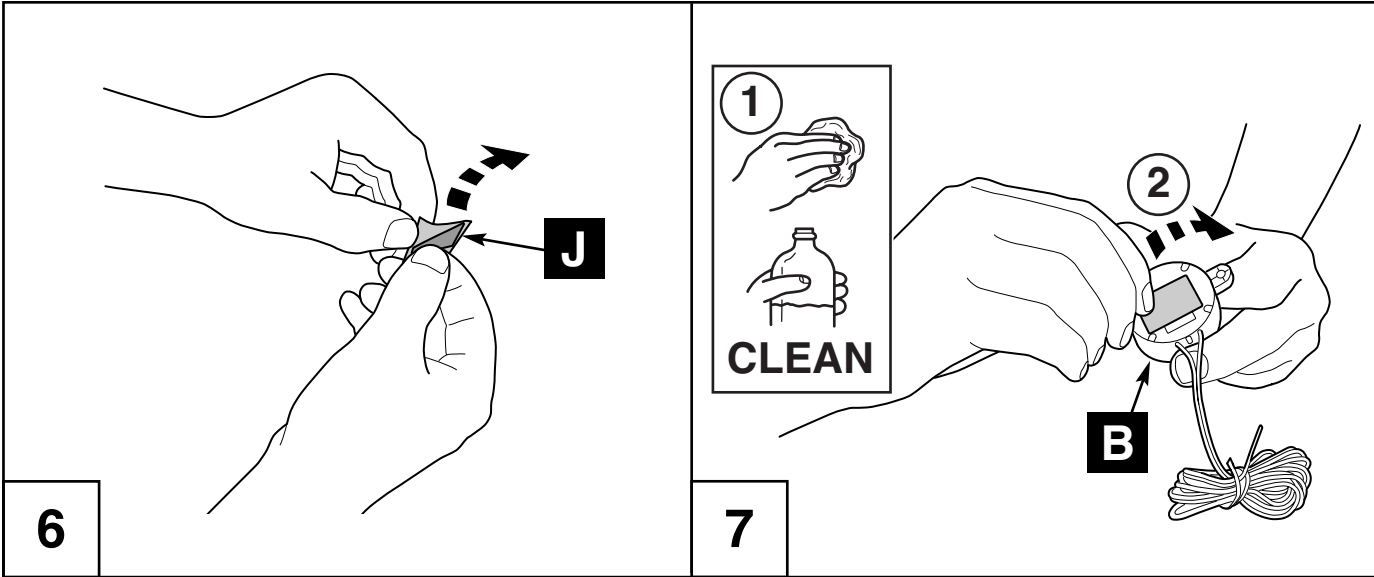

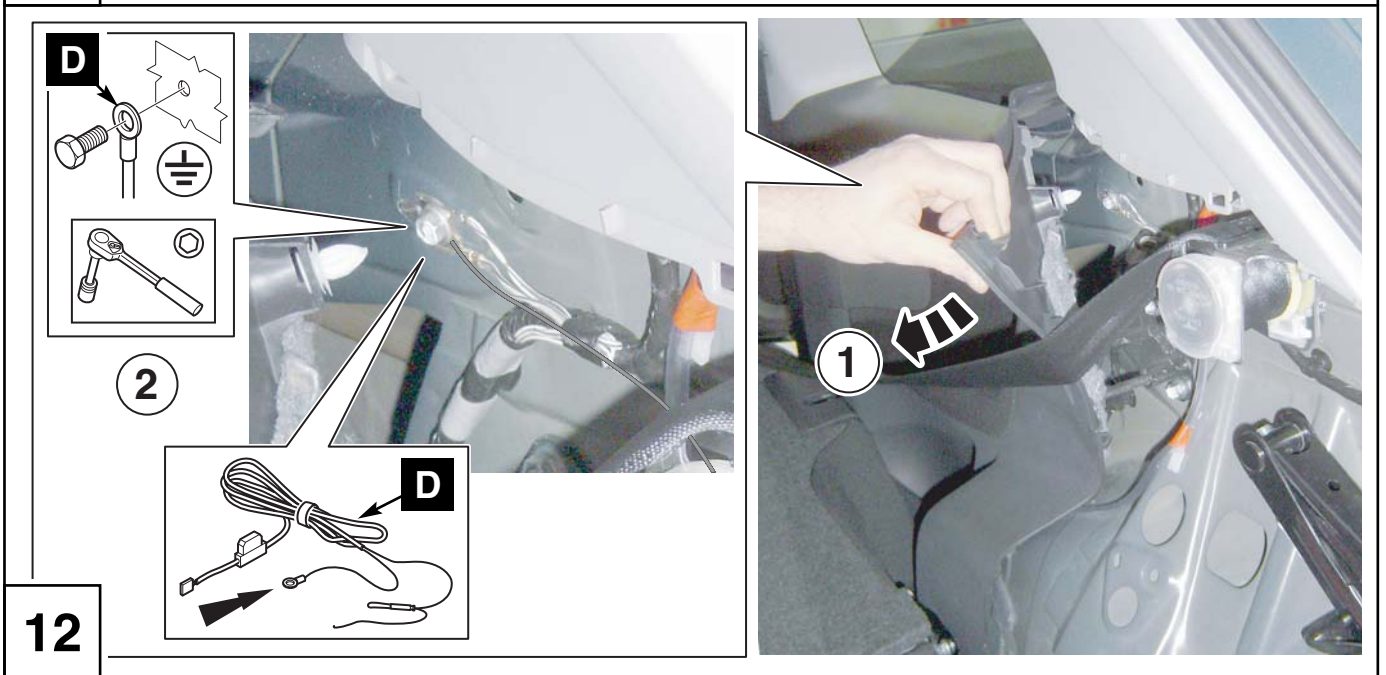
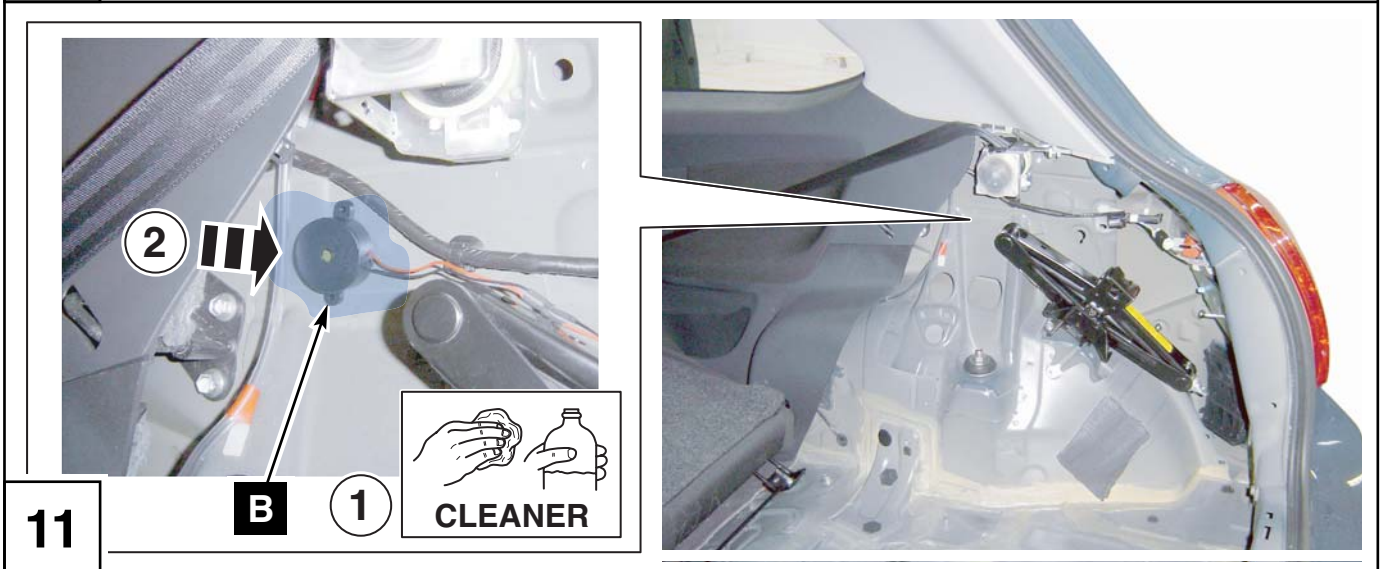
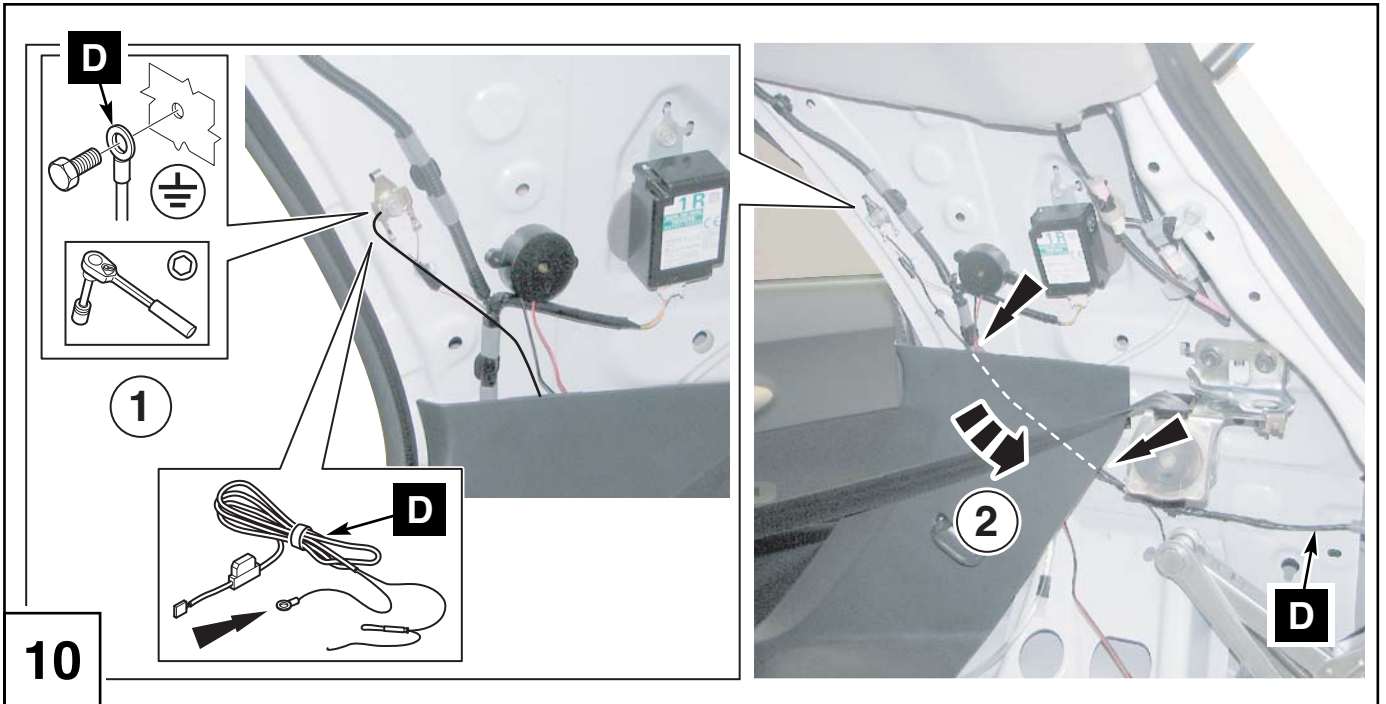

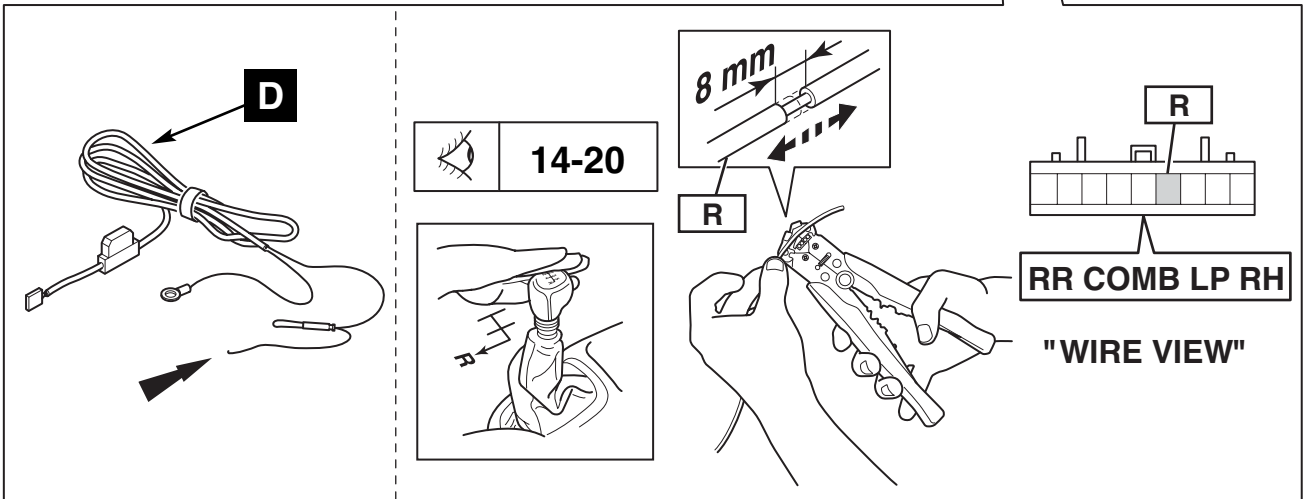
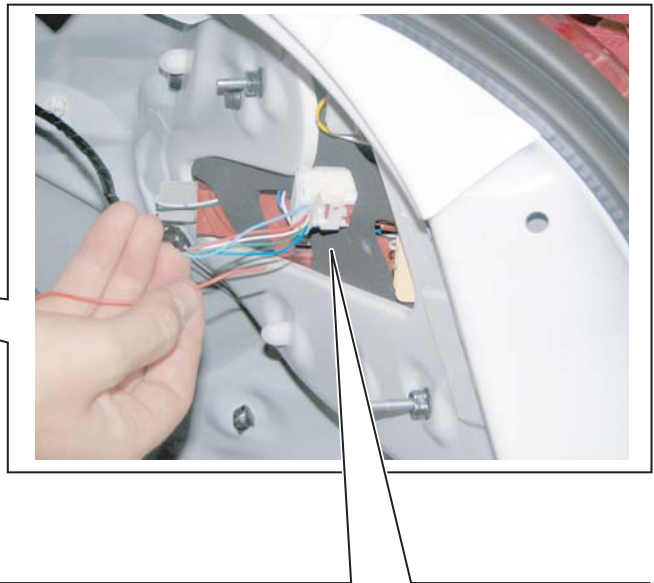
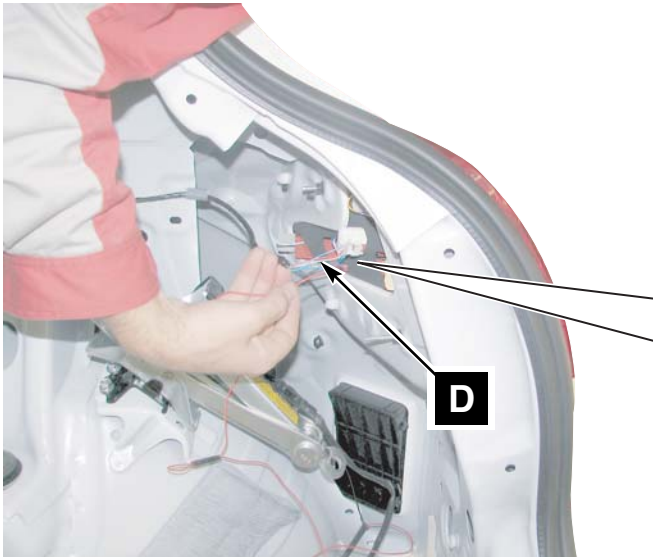

13

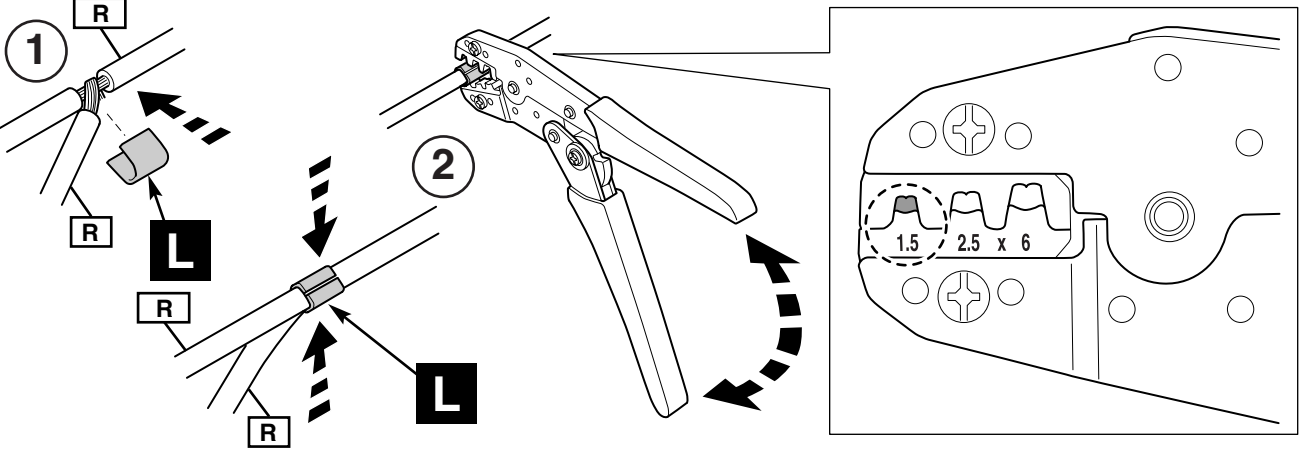

14



L

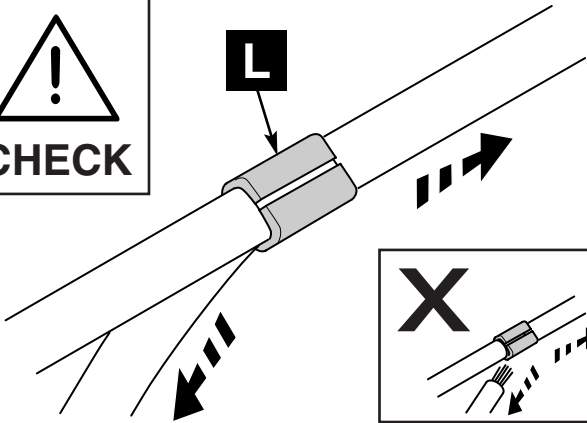

Ref: Toyota Wire Harness Repair
Pub No. RM 1022E Page B 30 - 31
Paragraph 6

15

16

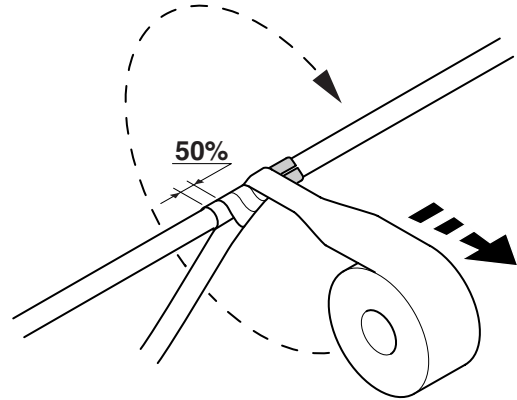
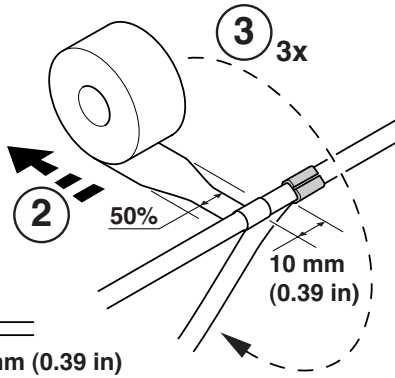
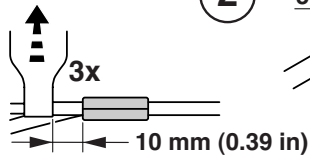

17

18

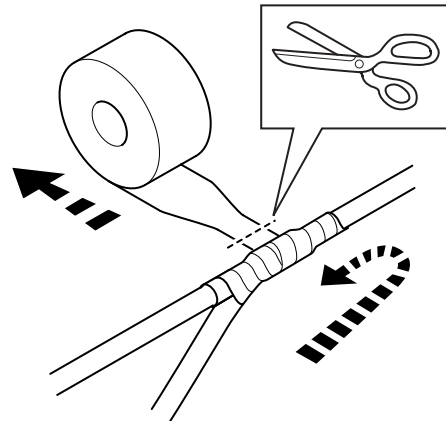
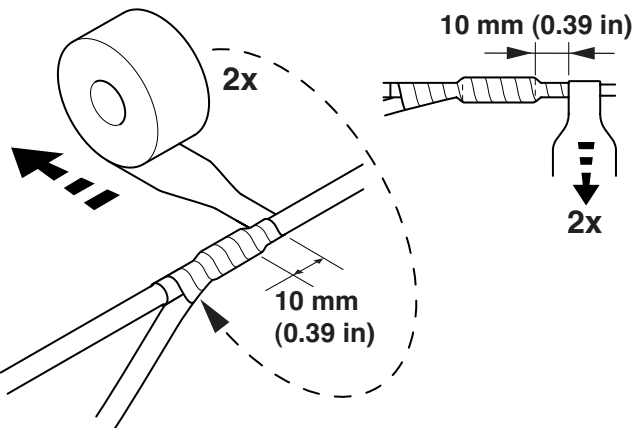

19

20

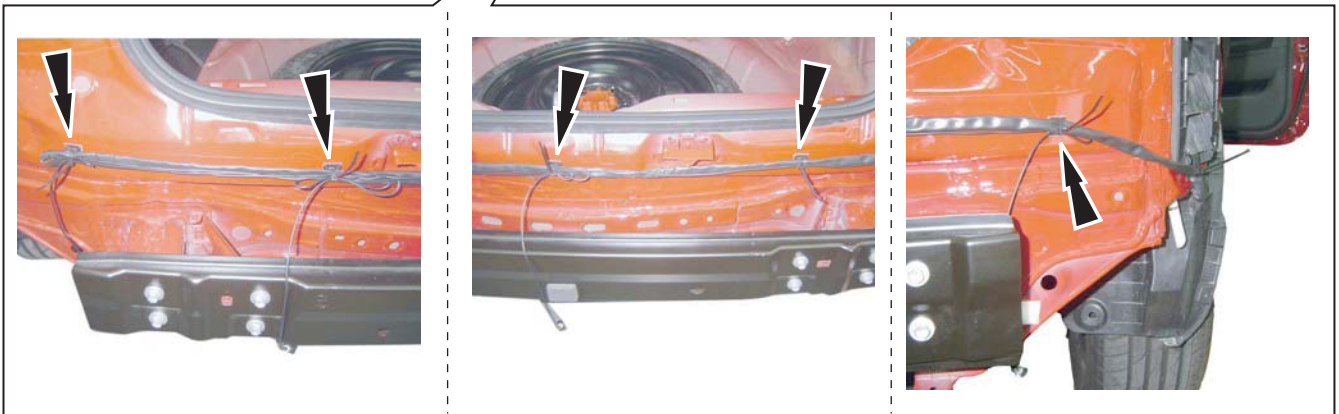
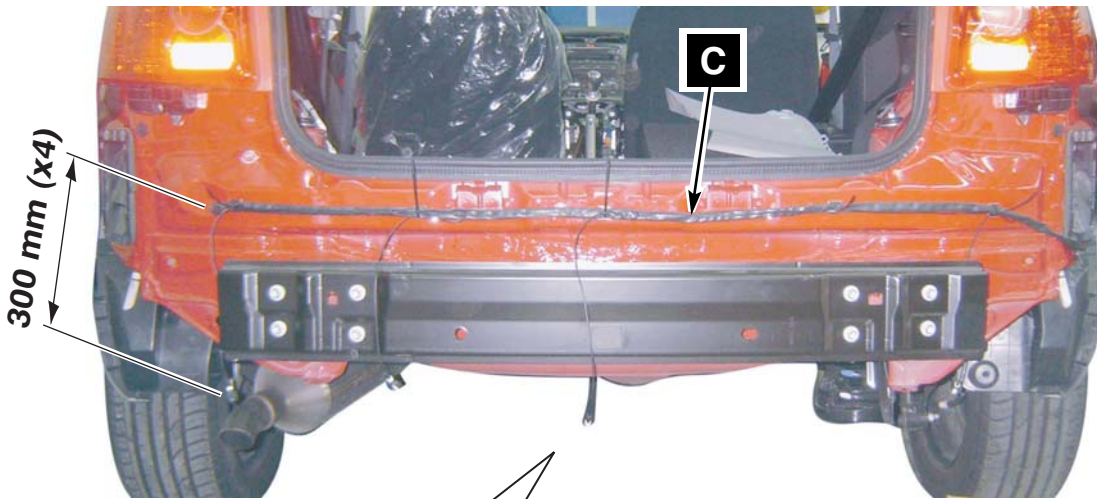
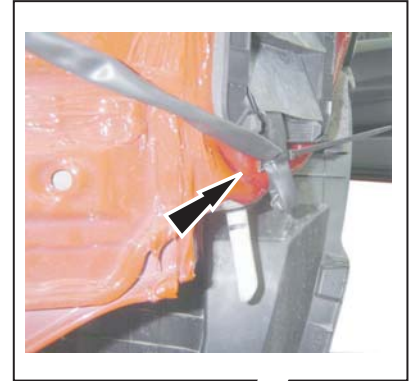
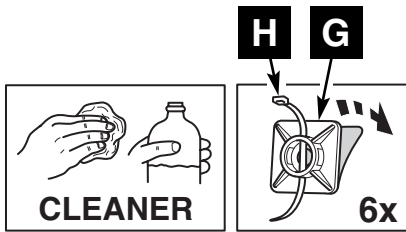

21

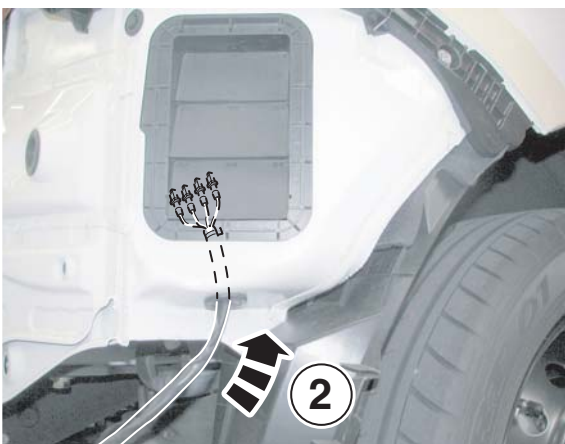
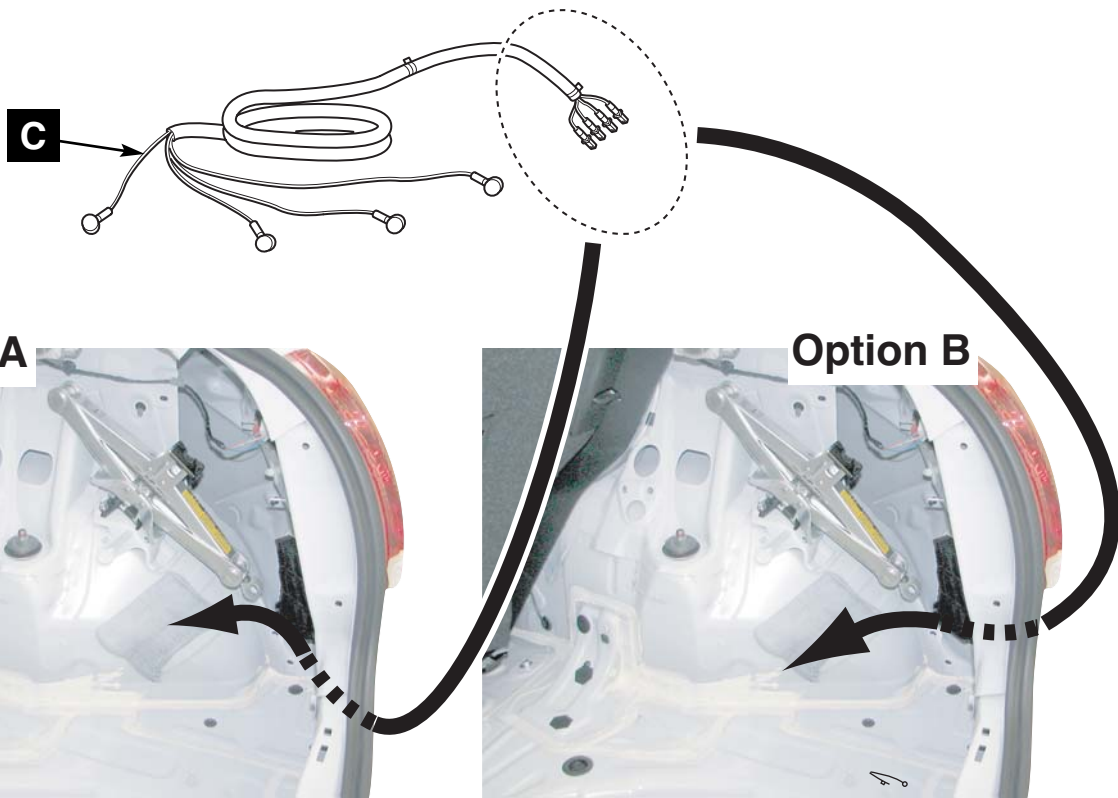

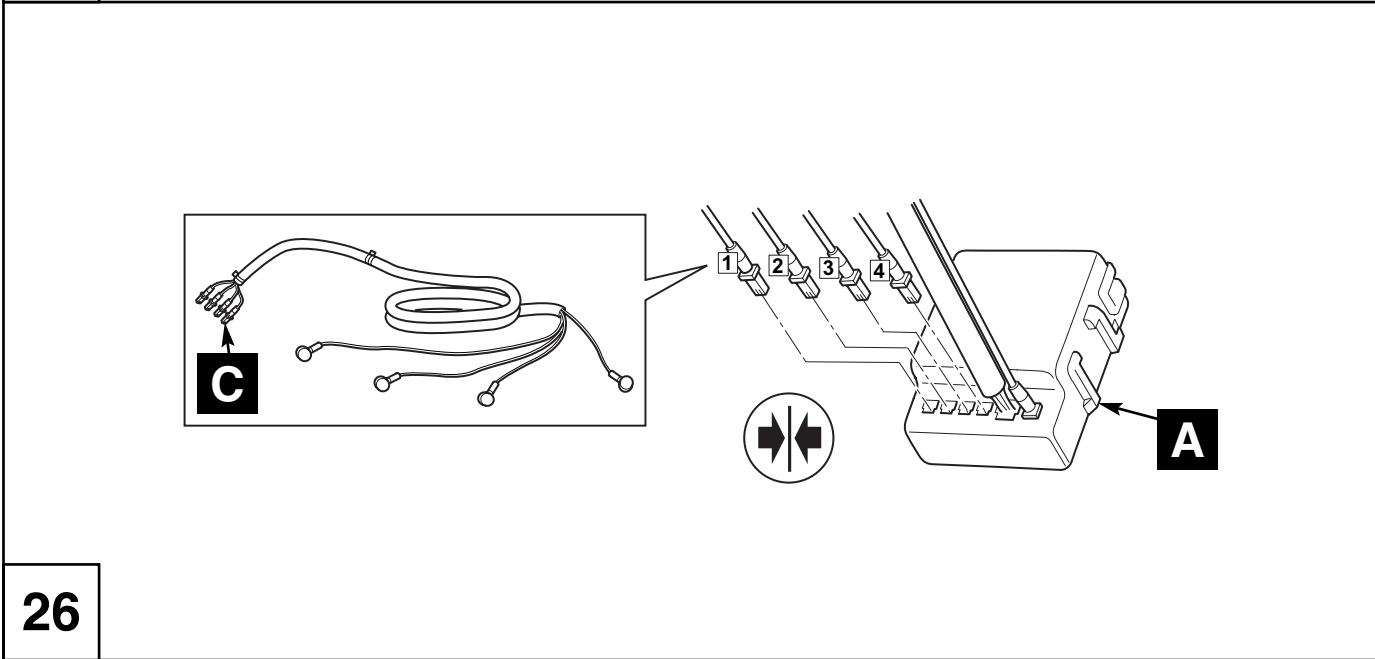
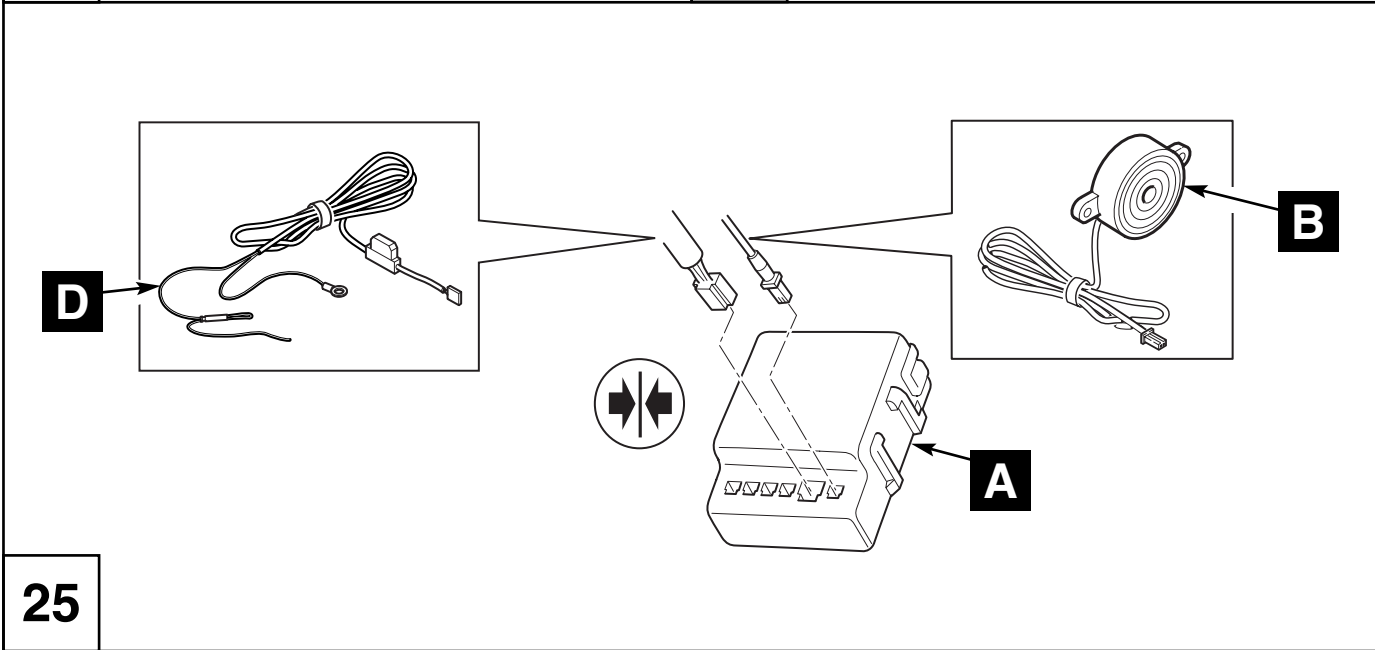
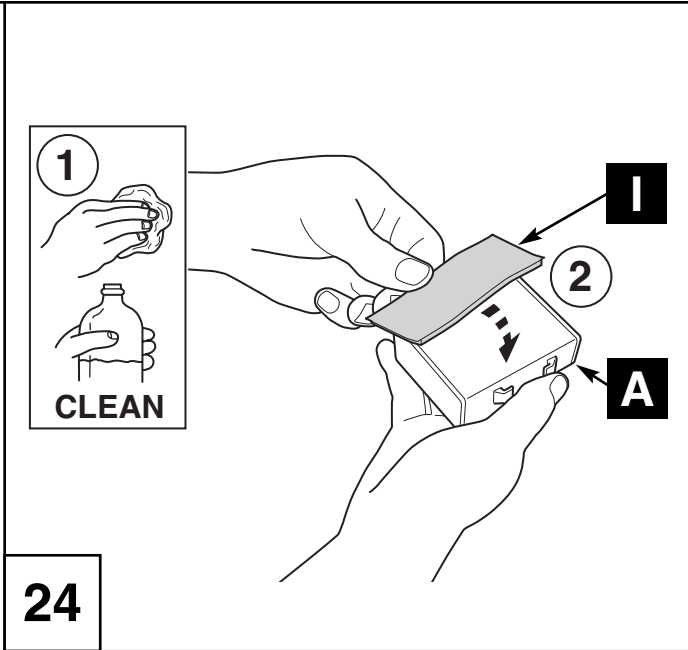
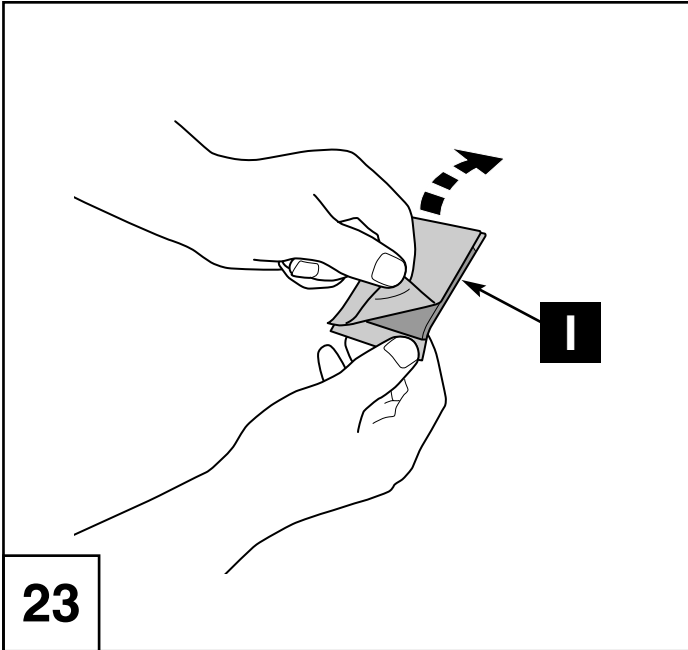

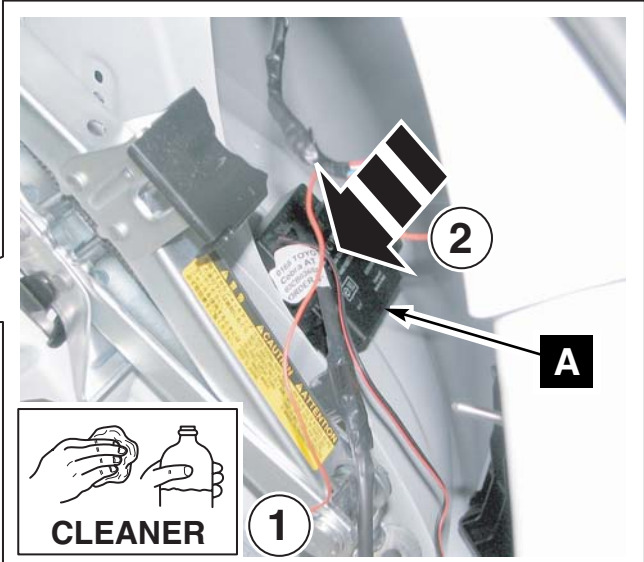
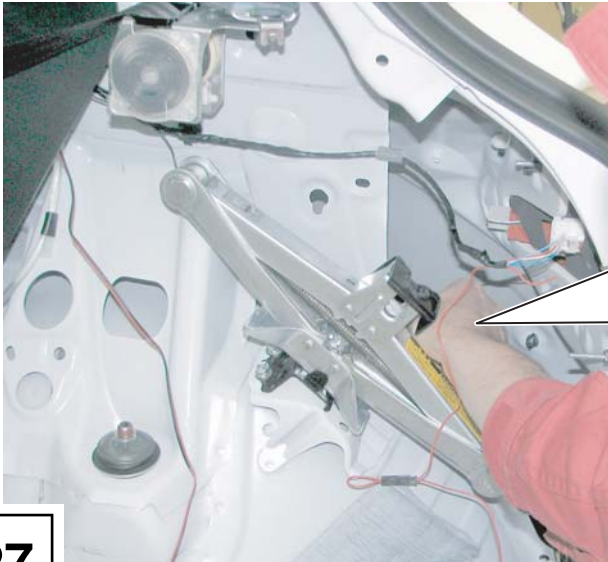

27



1

2

A

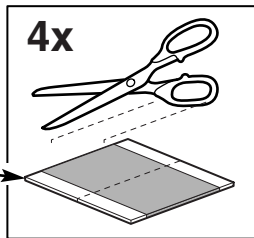

F

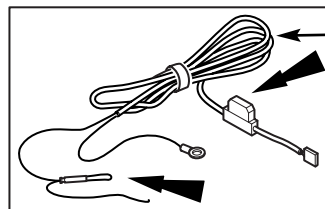

D

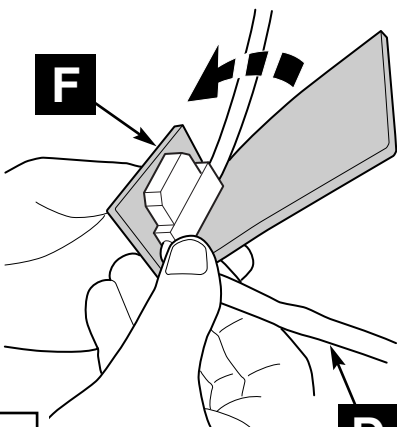

F

D

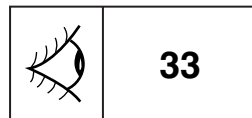
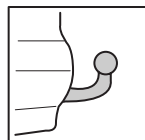
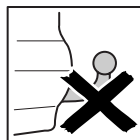

33

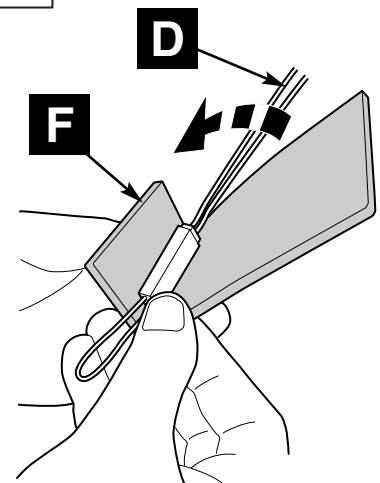

D

F

28

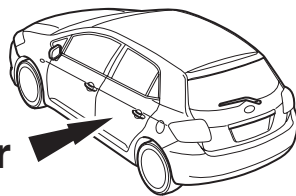

5 dr

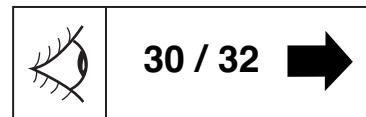

30 / 32

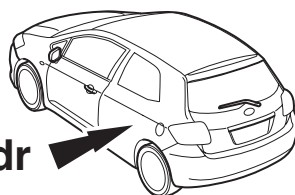

3 dr

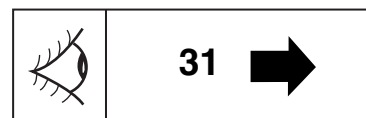

31

29

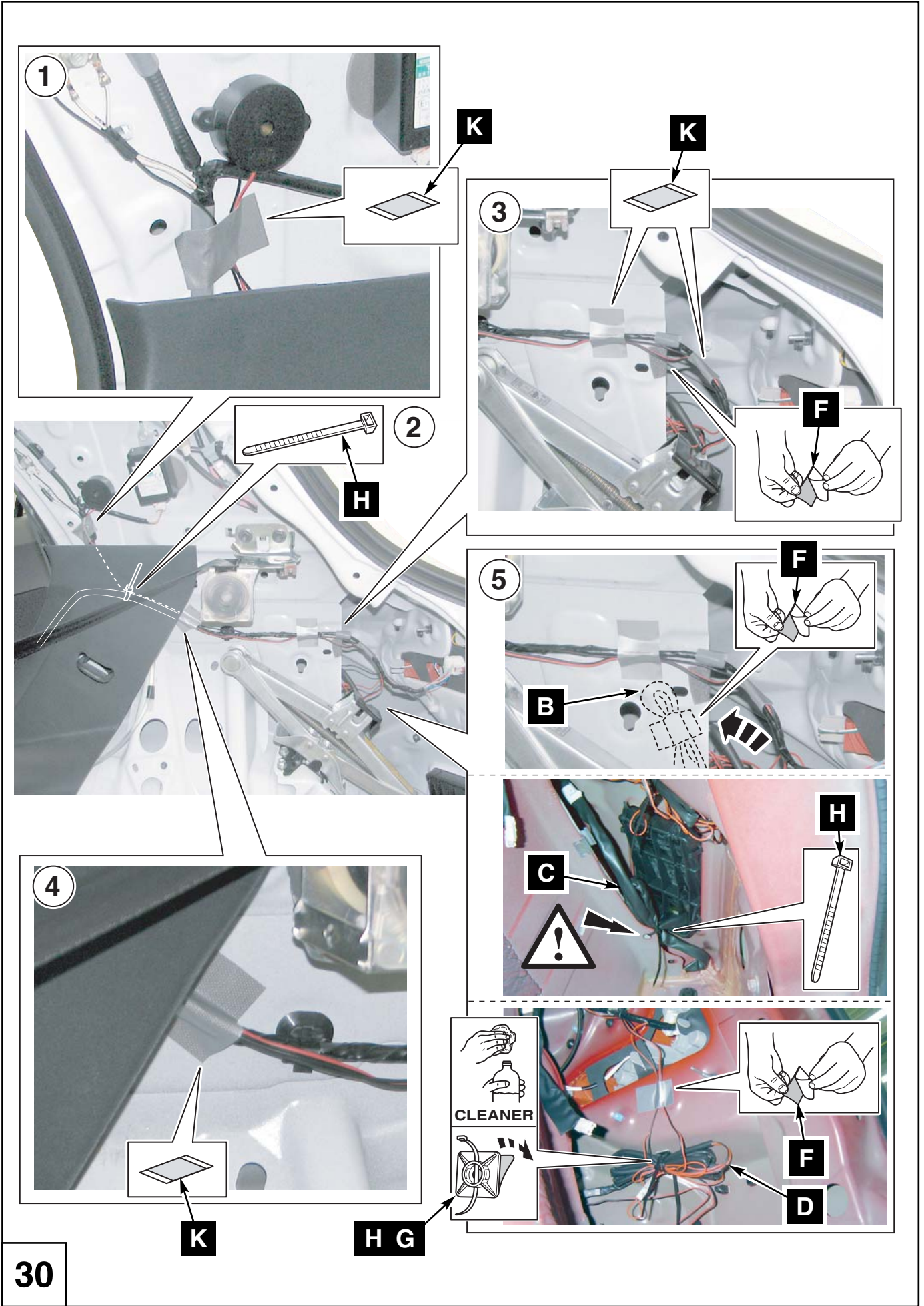

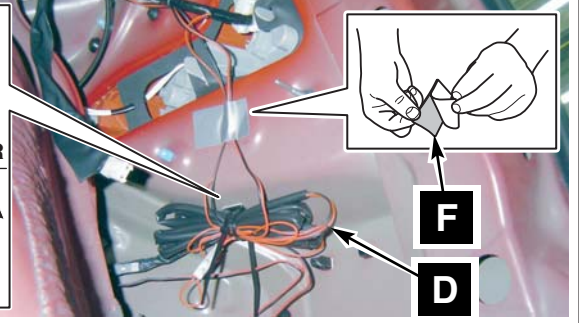
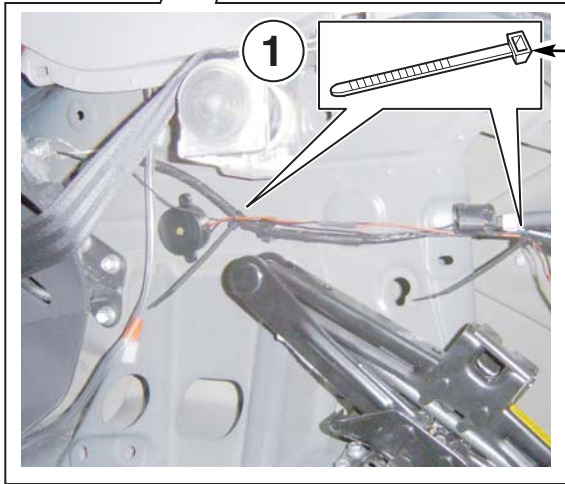
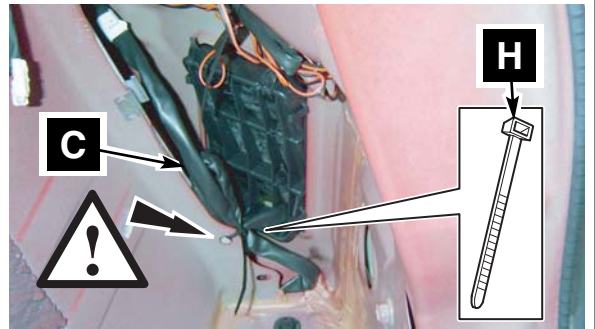
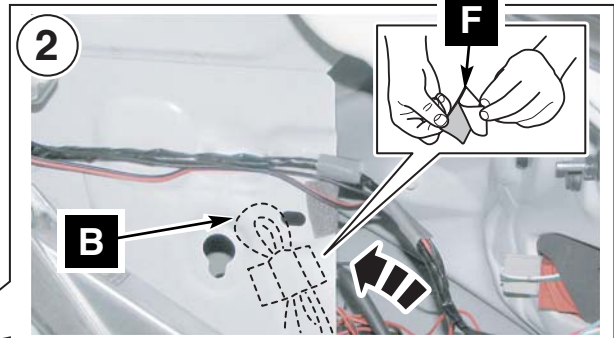
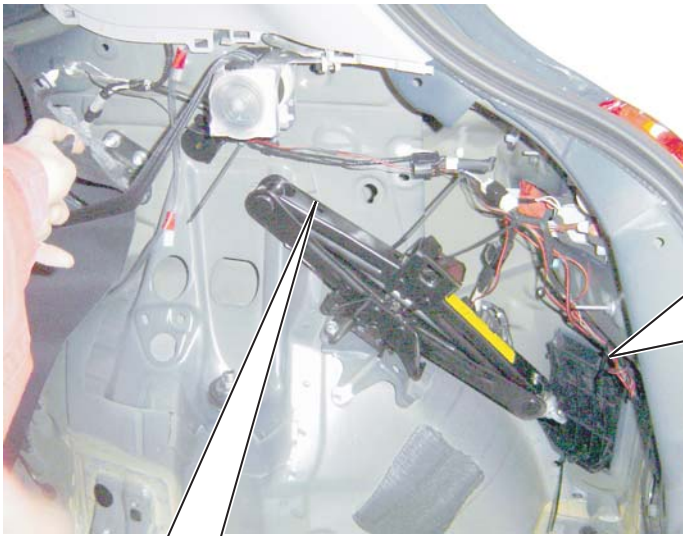

H G

31

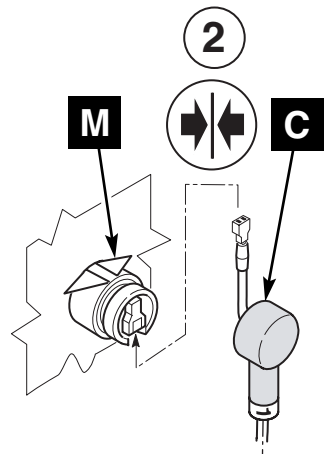
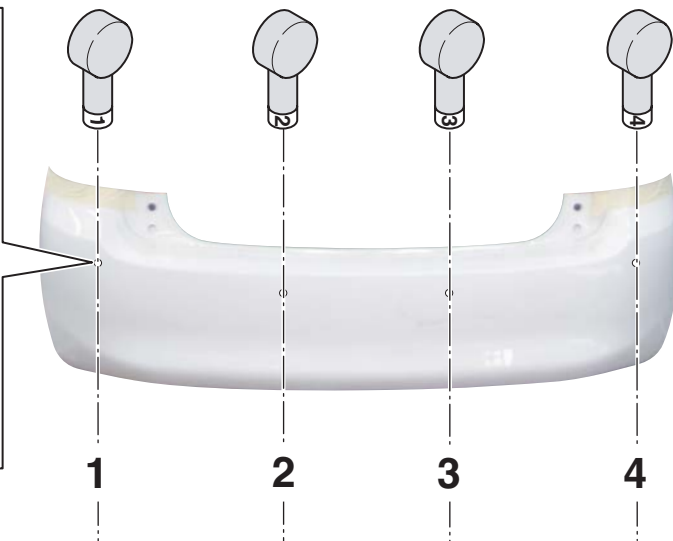
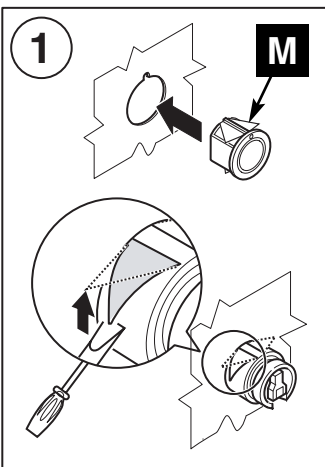

32

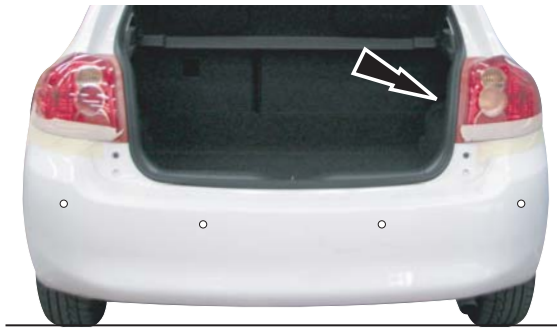

Optional

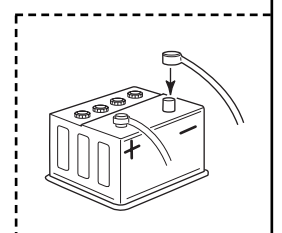
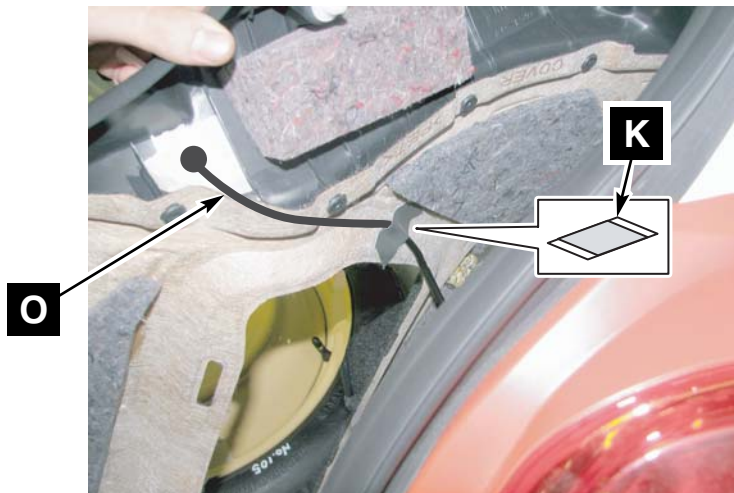
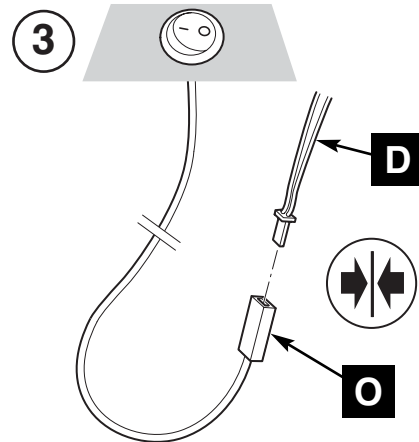
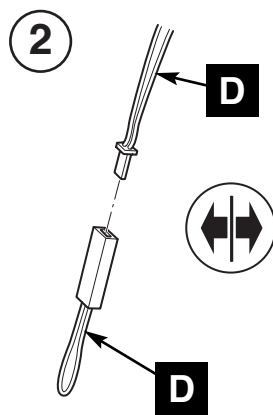
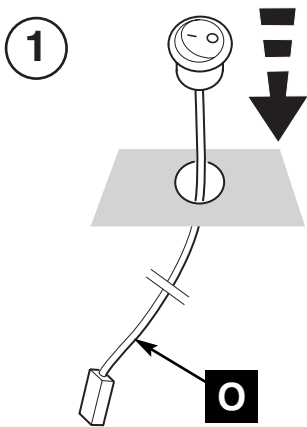
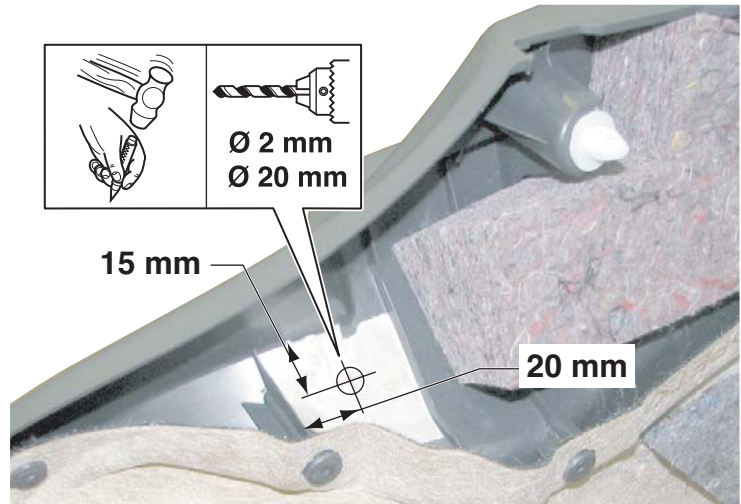
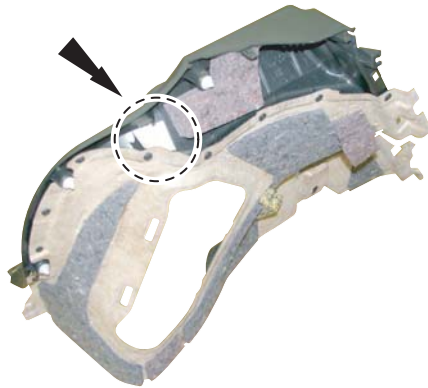

33

D

Hinweise zur Lackierung !!!

- 1) **Schleifen:** Schleifen der Teile mit Scotchbrite
- 2) **Reinigung:** Reinigen mit Silikonentferner (z.B. **Toyota Hydro Cleaner PZ469-A0002-50**)
Abwischen des Teiles mit einem Staubbindetuch (z.B. **Fa. BERNER Art. 85910.1**)
- 3) **Decklackierung unter Verwendung von :**
z.B. **Toyota Hydro Base coat, ...**
- 4) **Klarlackierung unter Verwendung von :**
z.B. **Toyota 2K HS Clear PZ469-C0002-50, ...**
- 5) **Trocknung:**
- Bei max. 40°C für mind. 1 Std. oder Lagerung bei Raumtemperatur über Nacht (Staubtrocken)
Lagerung für mind. 24 Std. bei Raumtemperatur (vollkommen ausgehärtet)
- 6) **Polieren:**
Sichtbare Staubeinschlüsse mit Schleifblüten (z.B. **Fa. 3M 13444**) herausschleifen.
Das Teil mit Schleifpaste (z.B. **STANDOX**)
Polieren von Hand oder mit einer Poliermaschine
Von Hand mit Glanzpolitur (z.B **STANDOX Lackpolish Siliconfrei**)
Polieren von Hand oder mit Poliermaschine.

ACHTUNG HERSTELLERHINWEISE BEACHTEN !!!

GB

Painting Instruction !!!

- 1) **Sanding:** Sand with Scotchbrite
- 2) **Cleaning:** Clean with silicone remover (e.g **Toyota Hydro Cleaner PZ469-A0002-50**)
Wipe part with dustbonding cloth (e.g. **Fa. BERNER Art. No. 85910.1**)
- 3) **Base coating :**
e.g **Toyota Hydro Base coat, ...**
- 4) **Clear coating:**
e.g. **Toyota 2K HS Clear PZ469-C0002-50, ...**
- 5) **Drying:**
- At max 40 °C for at least 1 hour or let it dry overnight at room temperature (dust dry)
Storage at for at least 24 hours at room temperature (thoroughly hardened)
- 6) **Polishing:**
Sand visible dust enclosures with sand paper (e.g. **Fa. 3M 13444**)
Rub part with polish paste (e.g **STANDOX**)
Polish with shinypolish by hand and high polish with a clean polishing cloth
(e.g **STANDOX Paintpolish w/o silicone**)

FOLLOW INSTRUCTIONS OF PAINT SUPPLIER !!!

F

Conseils Pour La Peinture !!!

- 1) **Ponçage:** poncer la pièce avec Scotchbrite
- 2) **Nettoyage:**
Nettoyer avec un dissolvant à silicone (ex. : **Toyota Hydro Cleaner PZ469-A0002-50**)
Essuyer la pièce avec un chiffon antipoussière (ex. **Fa. BERNER Art. 85910.1**)
- 3) **Peinture finale en utilisant:**
ex. : Toyota Hydro Base coat (peinture de base) , ...
- 4) **Vernis Transparent :**
ex.: Toyota 2K HS Clear PZ469-C0002-50, ...
- 5) **Séchage:**
- A max. 40°C min. pendant une heure ou une pose à température ambiante pendant la nuit
(hors poussière) Entreposage de 24 heures minimum à température ambiante (entièrement durci).
- 6) **Polissage:**
Polir des impuretés visibles avec du papier-émeri (ex. **Fa. 3M 13444**).
Enduire la pièce de pâte abrasive
(**ex : STANDOX**)
et polir manuellement ou à la machine.
Polir à la main avec un vernis brillant (**STANDOX Paintpolish w/o silicone**)
Polir manuellement ou à la machine.

ATTENTION! RESPECTER LES CONSEILS DU FABRICANT !!!

NL

Aanwijzingen voor het lakken !!!

- 1) **Schuren:** Schuren van de onderdelen met Scotchbrite
- 2) **Reiniging:**
Reinigen met siliconenverwijderaar **Toyota Hydro Cleaner PZ469-A0002-50**
schoonvegen van het onderdeel met een stofbindende doek (**bijv. firma BERNER Art. 85910.1**)
- 3) **Deklaag met gebruik van:**
bijv. Toyota Hydro Base coat, ...
- 4) **Klaarlak met gebruik van:**
bijv. Toyota 2K HS Clear PZ469-C0002-50, ...
- 5) **Droging:**
Op max. 40°C gedurende min. 1 uur of opslag bij kamertemperatuur gedurende een nacht
(stofdroog) Opslag gedurende min. 24 uren op kamertemperatuur (volkomen uitgehard)
- 6) **Polijsen:**
Zichtbare stofafzettingen met schuurvellen (**bijv. firma 3M 13444**) uitschuren.
Het onderdeel met schuurpasta (**bijv. STANDOX**)
polijsten met de hand of met een polijstmachine
Met de hand met glansmiddel (**bijv. STANDOX Standohyd Lackpolish Siliconvrij**) polijsten
of met polijstmachine.

OPGELET AANWIJZINGEN VAN DE FABRIKANT IN ACHT NEMEN!!!

