



Land Cruiser V8

Dog Guard (and optional Divider)

Installation instructions

Model year:	09/2007
Vehicle code:	**J200L-G**E*W
Part number:	PZ483-70121-00 and PZ483-70122-00 (Divider)
 Weight:	6 kg + 5 kg (divider)

Manual reference number: AIM 001 087-1

A

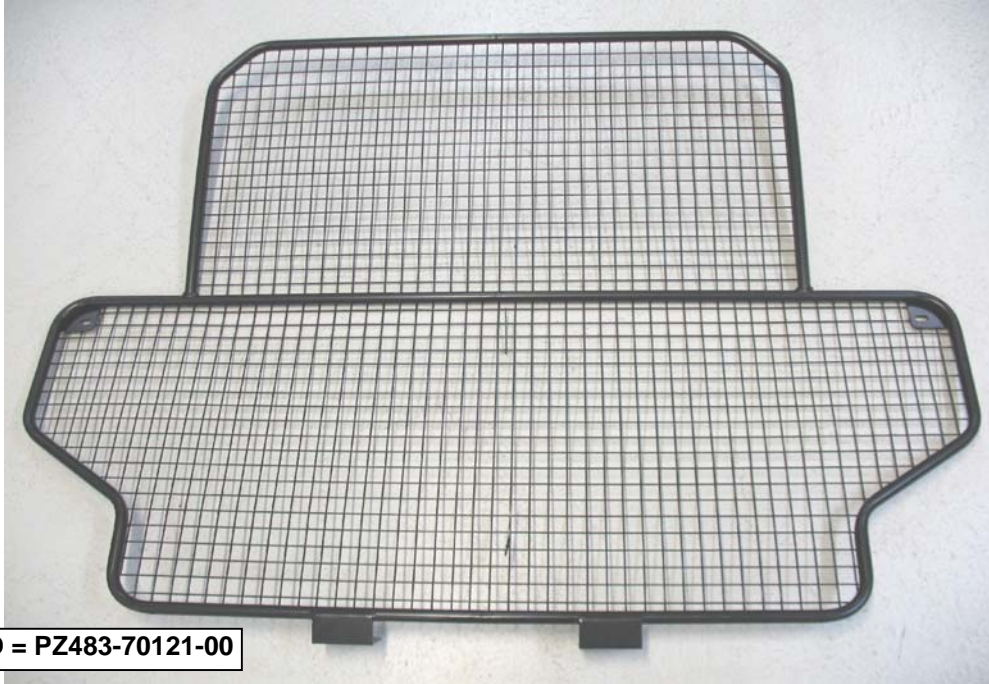

A+B+C+D = PZ483-70121-00

B



D



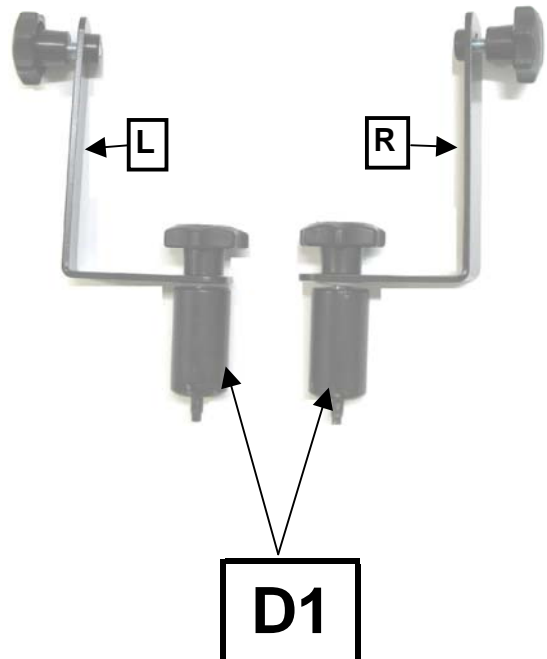

B+C+D = PZ483-70121-60



C



Legend

-  **STOP:** Damage to the vehicle may occur. Do not proceed until process has been complied with.
-  **OPERATOR SAFETY:** Use caution to avoid risk of injury.
-  **CRITICAL PROCESS:** Proceed with caution to ensure a quality installation.
-  **GENERAL PROCESS:** This highlights specific processes to ensure a quality installation.
-  **TOOLS & EQUIPMENT:** This calls out the specific tools and equipment required for this process.

TOOLING LIST : 5 SEATER

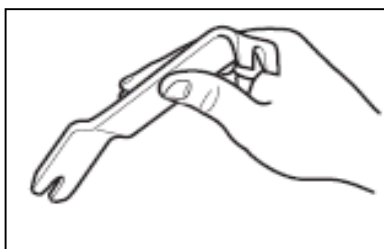
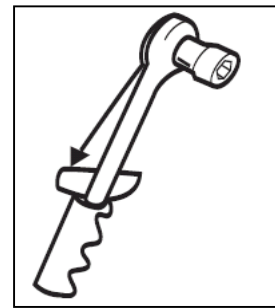
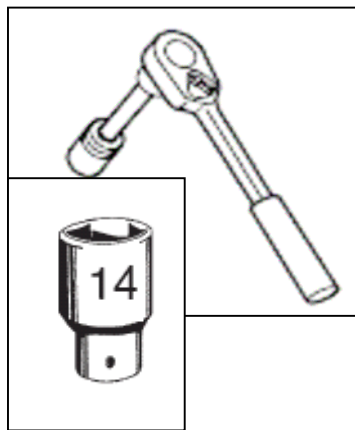
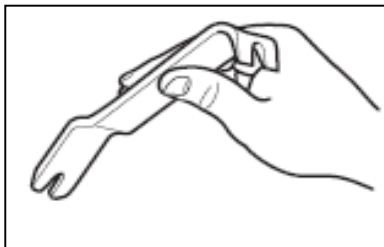

TOOLING LIST : 7 SEATER

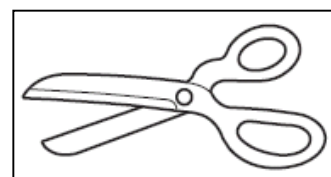
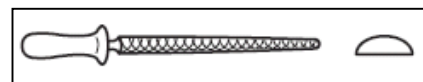
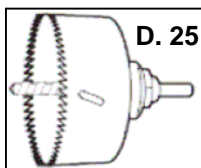
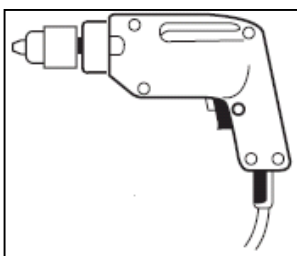
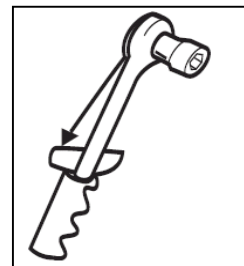
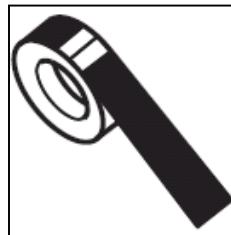
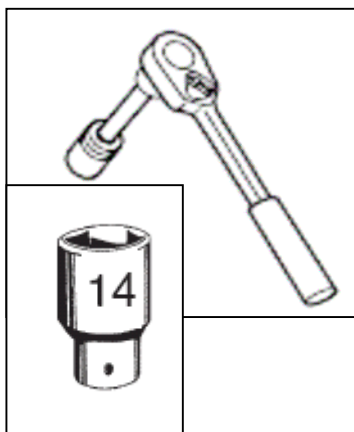
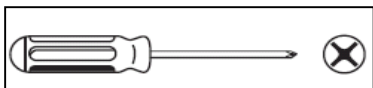

5 + 7 SEATER

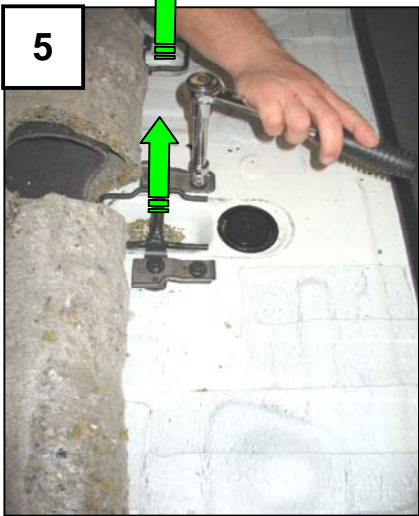
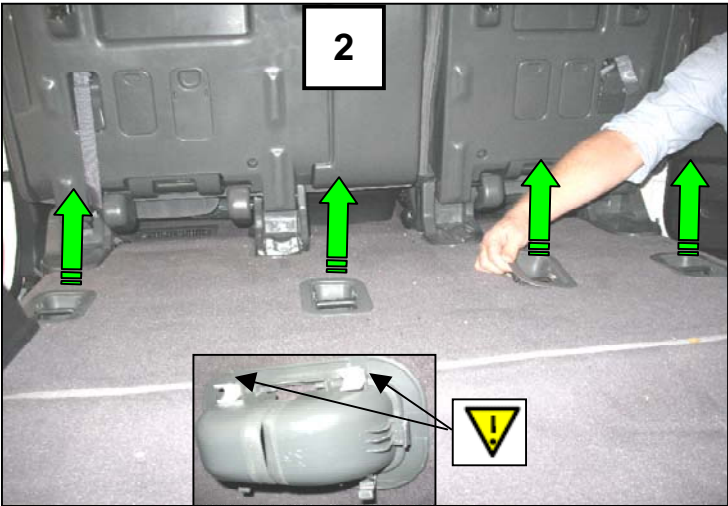

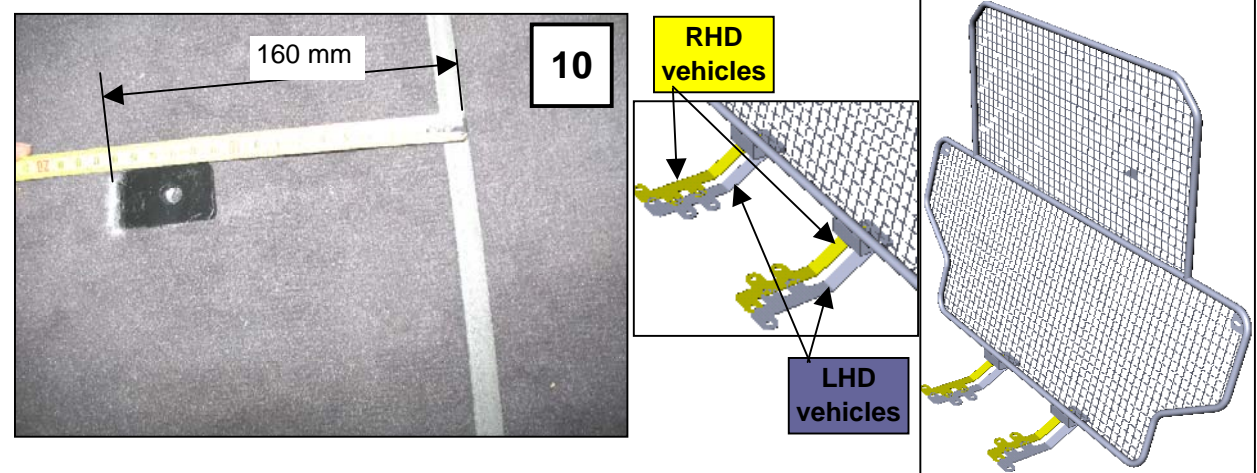
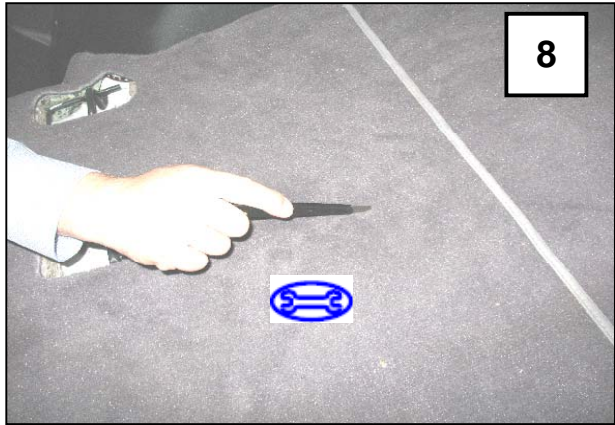
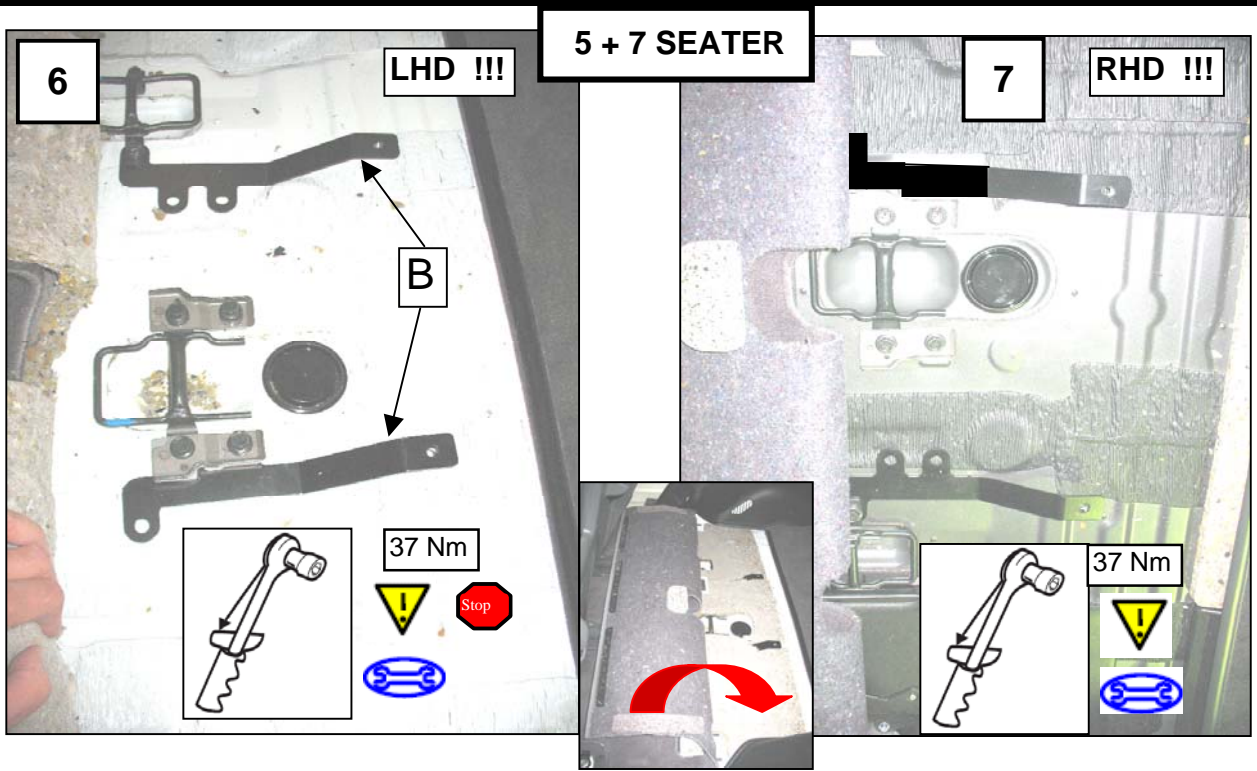

7 SEATER ---> PAGE 9

5 SEATER

11

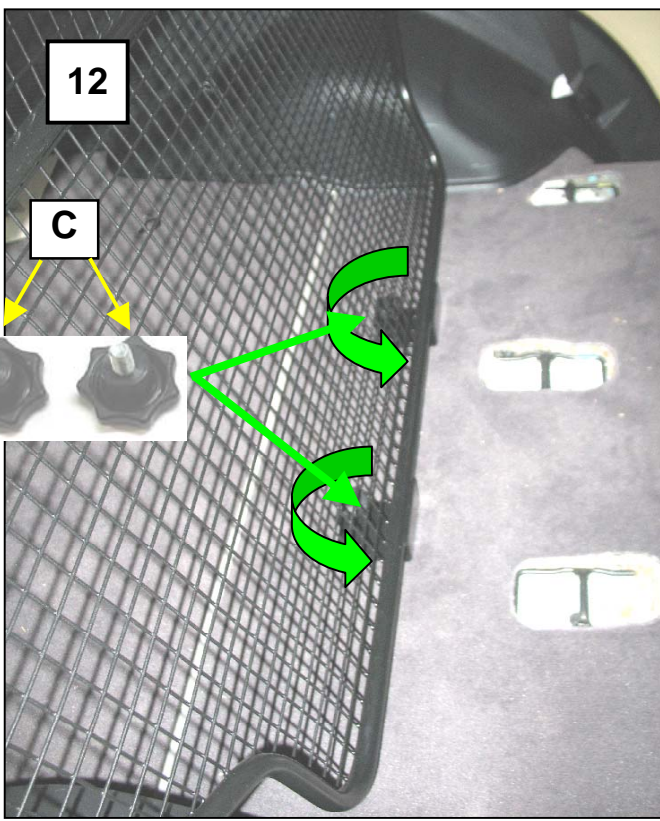
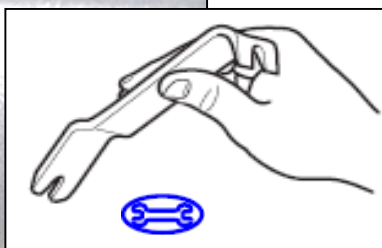
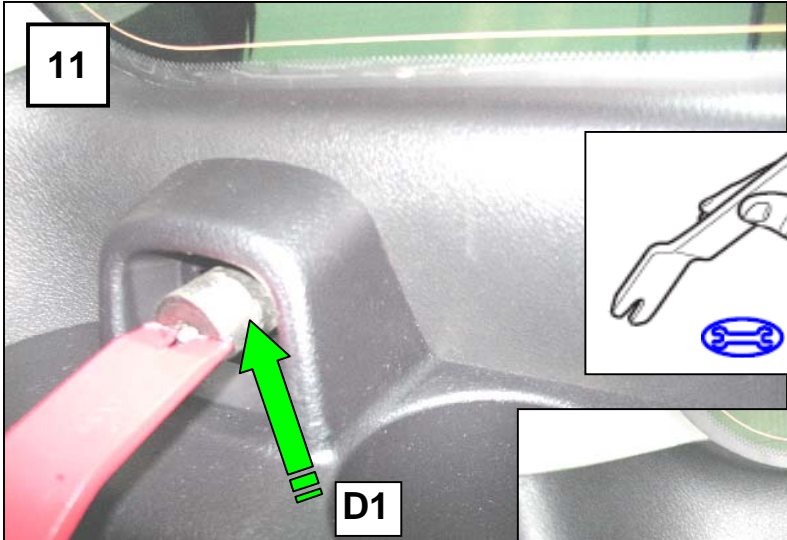

5 SEATER

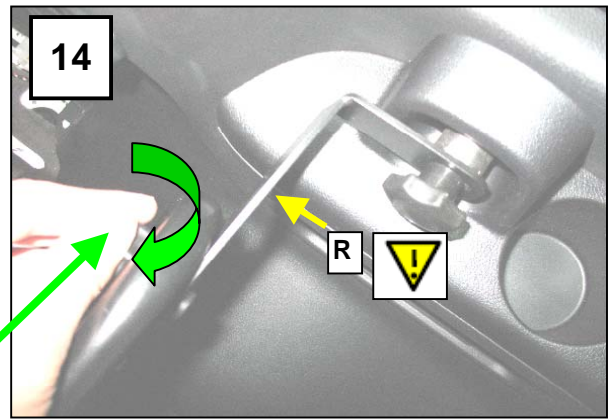
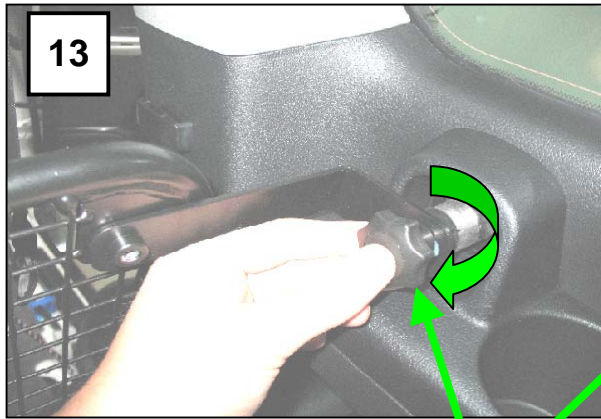

C



7 SEATER

STEP 1-10

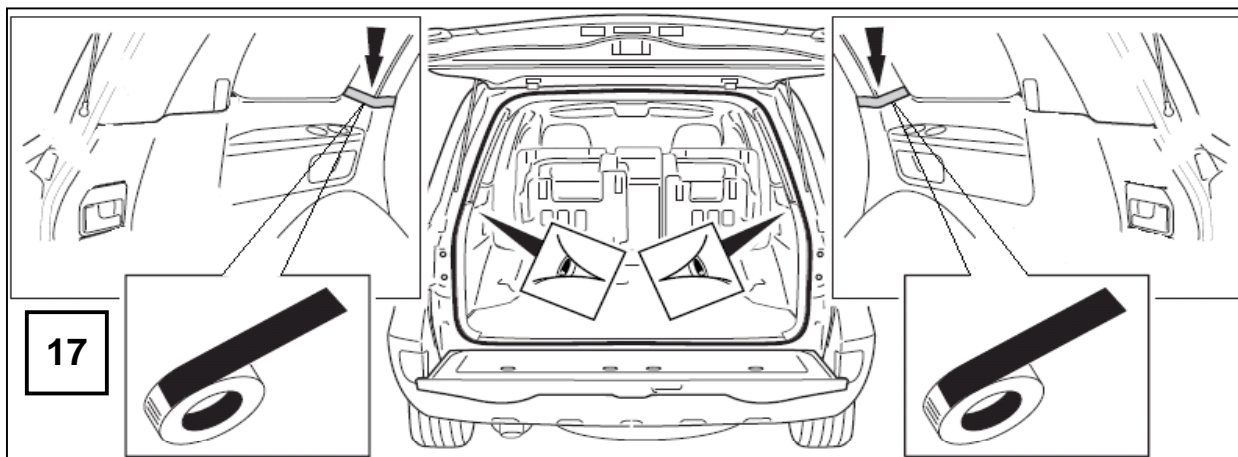
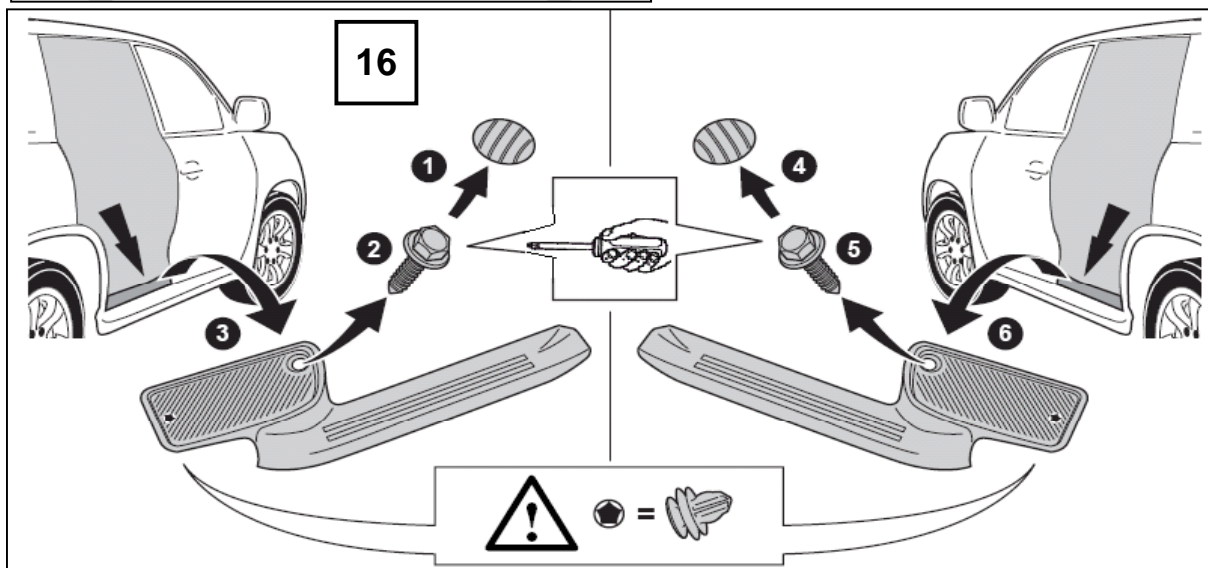
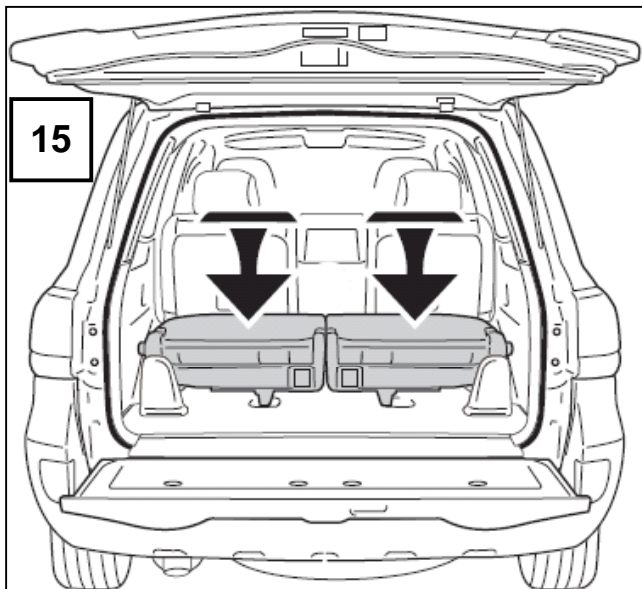

7 SEATER

18

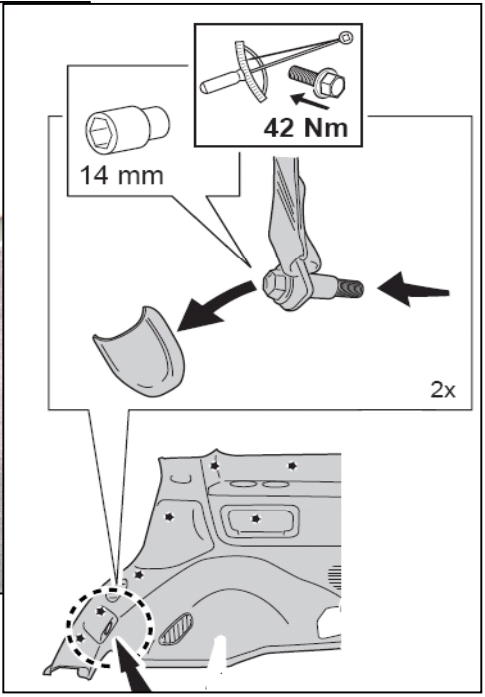

19

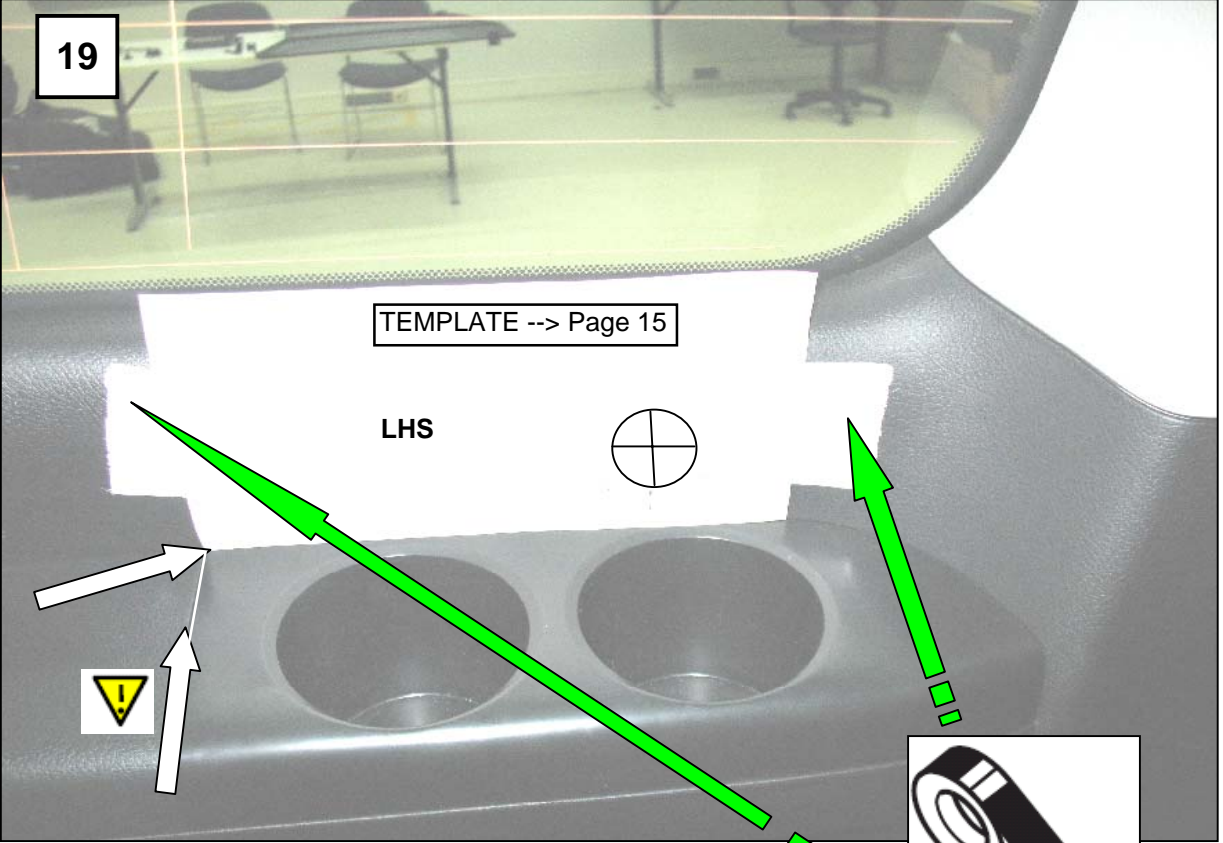

TEMPLATE --> Page 15

LHS

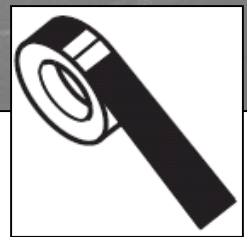
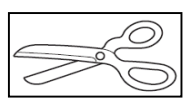

7 SEATER

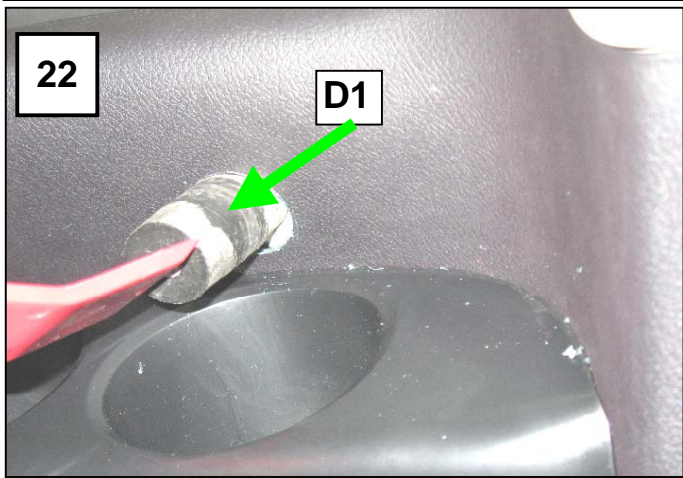
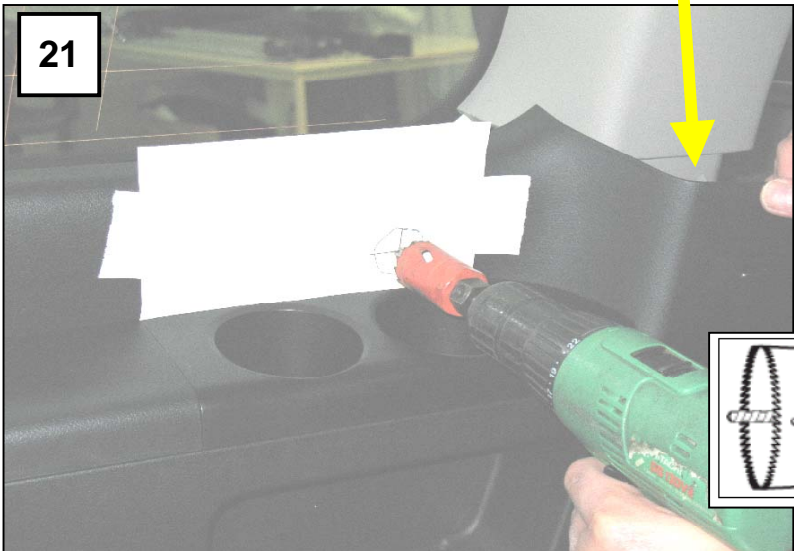
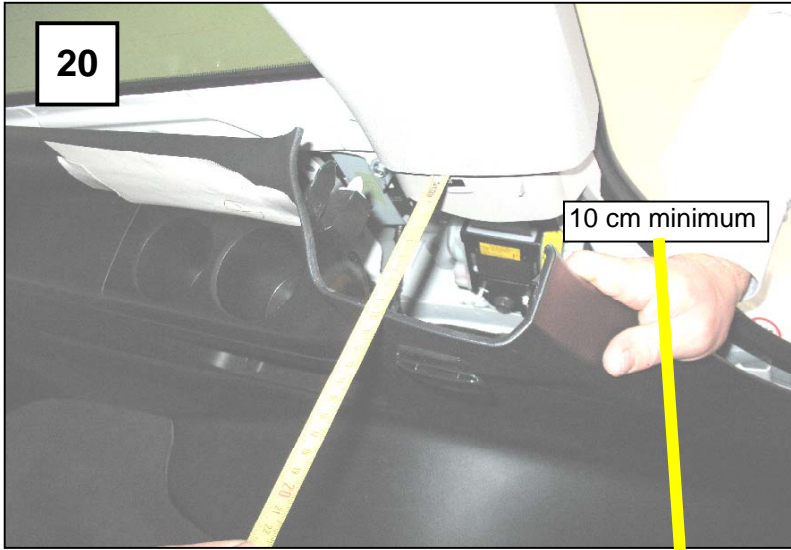

-----> PICTURE 12 -----> PICTURE 13 -----> PICTURE 14

E



E+F+J = PZ483-70122-00

F



J



5 + 7 SEATER



7 SEATER

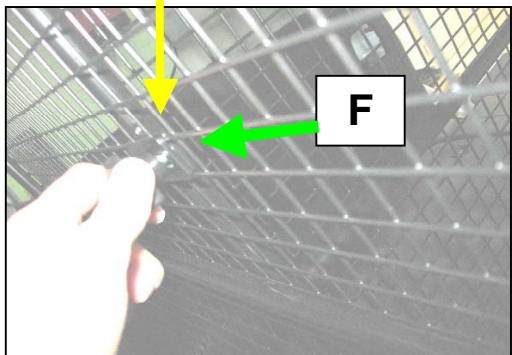
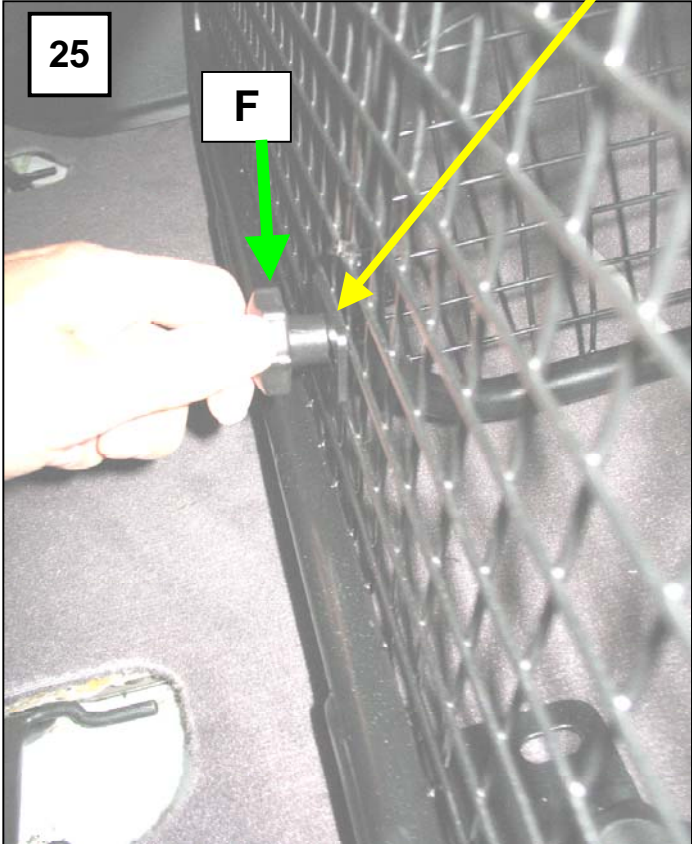
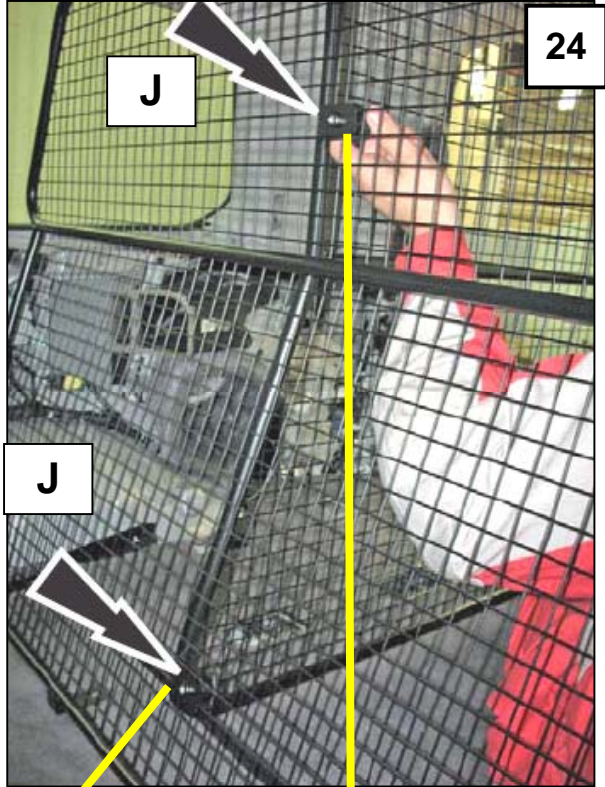

5 + 7 SEATER

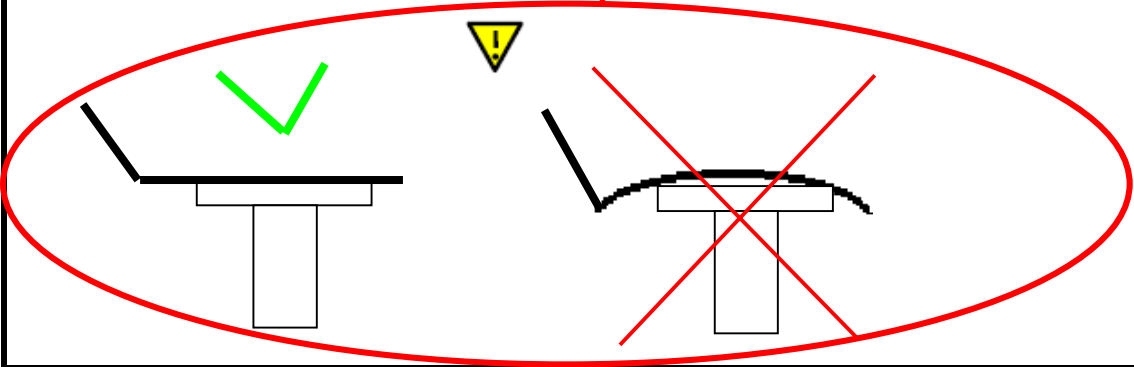
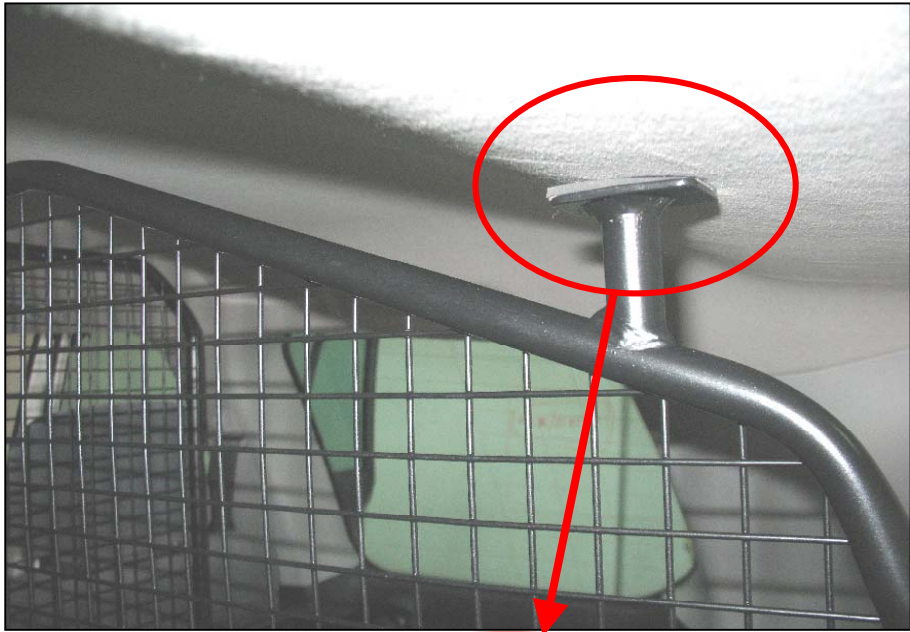

7 SEATER

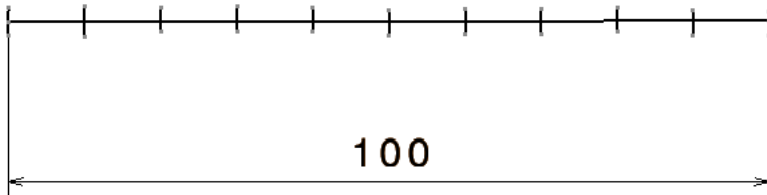
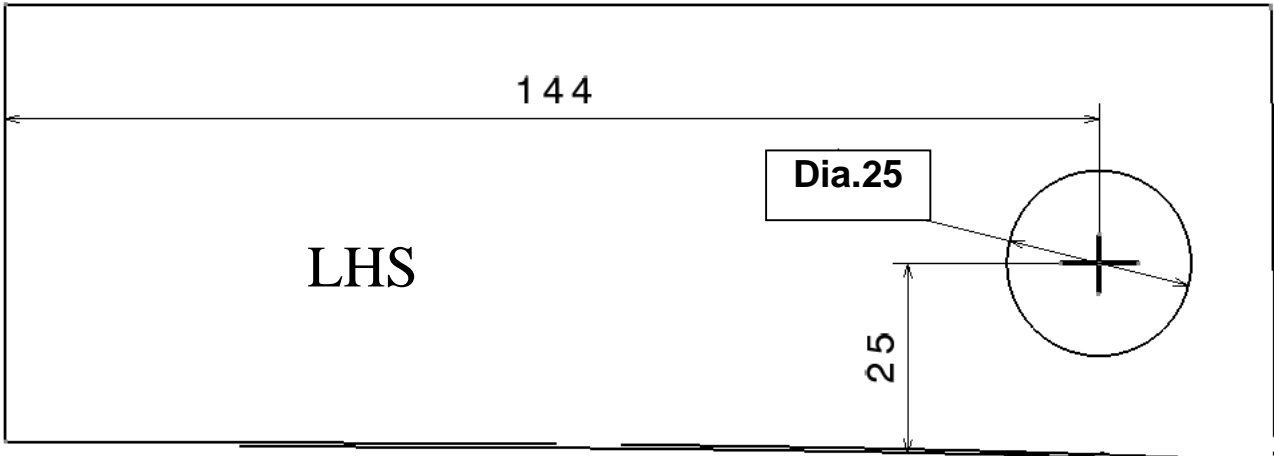
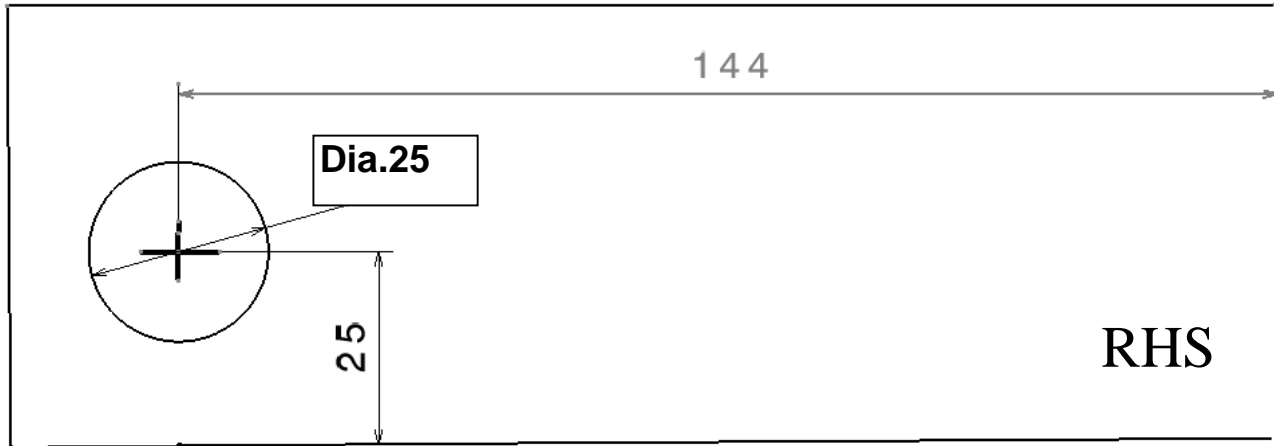

CHECK
SCALE

