



RAV4 (RHD)

JBL Premium sound

Installation instructions

Model year:	2007	
Vehicle code:	**A3*R-A****W	
Part number:	Main kit	PZ490-X0230-00
	Fitting kit	PZ457-X0230-00
	Back door grille	64033-42010-B0
	Rivets	16x 90269-05034
	JBL sticker set	PZ438-00230-00
	Clip	5x 90467-09203
 Weight:	10 kg	

Manual reference number: AIM 001 126-0

Revision Record

Rev. No.	Date	Page	Picture	Update	New	Deleted Steps

Large empty rectangular area for additional notes or details.

EN

- Expert Fitment Required.
- Disconnect the battery earth cable.
- To avoid damage to the wiring harness, ensure contact with sharp edges is prevented.
- Install parts as shown on illustrations.
- Re-connect battery.
- Re-fit panels, ensure that the wiring harness and other components are neatly and securely located.

DE

- Montage durch Fachwerkstatt erforderlich.
- Massekabel von Batterie abklemmen.
- Zur Vermeidung von Beschädigungen an der Kabelisolation ist Berührung mit scharfen Kanten zu vermeiden.
- Teile gemäß Abbildung montieren.
- Batterie wieder anschließen.
- Paneele wieder anbringen; achten Sie darauf, daß der Kabelbaum und andere Teile ordnungsgemäß und genau positioniert sind.

ES

- Montaje sólo por el concesionario.
- Desconectar el cable de masa de la batería.
- A efectos de evitar desperfectos en el aislamiento del cable, hay que evitar el contacto con aristas cortantes.
- Montar las piezas tal como se indica en las figuras.
- Vuelva a conectar la batería.
- Volver a colocar los paneles; preste atención a que el mazo del cable y las demás piezas tengan la posición correcta y precisa.

FR

- Montage par spécialiste nécessaire.
- Débrancher le câble de masse de la batterie.
- Eviter tout contact avec des arêtes vives afin de ne pas endommager l'isolation des câbles.
- Monter les pièces selon les figures.
- Reconnecter la batterie.
- Remettre le panneau; veillez à ce que le faisceau et les autres pièces soient positionnés correctement et avec la précision requise.

IT

- E' necessario in officina specializzata.
- Staccare il cavo di massa dalla batteria
- Allo scopo di evitare danni all'isolazione dei cavi, evitare di metterli a contatto con spigoli acuti.
- Montare le parti secondo quanto rilevabile delle illustrazioni.
- Riconnettere la batteria.
- Rimettere in posizione i pannelli; far ben attenzione che il fascio di cavi e le altre parti siano state posizionate con esattezza e nella dovuta maniera.

PT

- Especialista em montagem requerido.
- Separe o cabo de terra do acumulador.
- Para não se danificar a isolação dos cabos, é conveniente evitar-se contacto com arestas afiadas.
- Monte as partes conforme ilustrado.
- Recolocar a bateria
- Tornar a colocar os painéis; verificar se a árvore de cabos e outras peças estão na posição exacta e prescrita.

NL

- Montage door vakman nodig.
- Massakabel van accu losmaken.
- Ter vermindering van beschadiging aan de isolatie van de elektrokit dient contact met scherpe kanten te worden vermeden.
- Delen overeenkomstig afbeelding monteren.
- Accu weer aansluiten.
- Panelen weer monteren; let erop, dat de kabelboom en andere delen correct en netjes gepositioneerd worden.

DA

- Montage ved professionelt værksted påkrævet.
- Stelkabel fjernes fra batteri.
- Berøring med skarpe kanter skal undgås for at undgå beskadigelse af kabelisoleringen.
- Dele skal monteres i henhold til illustrationer.
- Tilslut batteri igen.
- Paneler fastgøres igen; vær opmærksom på, at kabelsamlingen og andre dele placeres korrekt og præcist.

NO

- Nødvendig med montering fra fagvegverksted.
- Klem jordkabelen av batteriet.
- For å unngå skader på kabelisoleringen må berøring av skarpe kanter unngås.
- Monter alle deler i henhold til illustrasjonene.
- Tilkoppl batteriet igjen.
- Monter panelene igjen, og pass på at kabelbunten og andre deler er anbrakt ordentlig og på riktig sted.

SV

- Verkstadsmontage erfordras.
- Lossa storkabeln från batteriet.
- För att förhindra skador på ledningarnas isolation skall beröring med vassa kanter undvikas.
- Montera detaljerna enligt figurerna
- Anslut batteriet igen.
- Sätt tillbaka panelerna igen; kontrollera noga att ledningsmattan och andra detaljer ligger på rätt plats.

FI

- Asennus tarpeen merkkikorkaamossa.
- Erotta maadoitusjohto akusta
- Pidä huoli myös siitä, että kaapelointi on korin kiinnityksen myötäinen ja kiinnitetty huolellisesti muihin liikkuviin osiin.
- Asenna osat kuvien mukaan.
- Kytke akku takaisin.
- Aseta paneelit paikalleen; tarkista, että kaapelointi ja muut osat ovat asianmukaisesti ja tarkalleen paikoillaan.

CS

- Montáž ve specializované dílně nutná.
- Odpojte zemnicí kabel od baterie.
- Zabraňte tomu, aby se kabely poškodily tím, že jsou položeny na ostrých hranách.
- Montujte části podle vyobrazení
- Opět připojit baterii.
- Opět připevněte panely; dbejte na to, aby svazek kabelů a ostatní části byly uloženy na správném místě.

HU

- A szereléshez szakműhely kell.
- Húzza le az akkumulátor testkábeljét.
- A kábelszigetelés megsérülésének elkerülésére ügyeljen arra, hogy a kábel ne juthasson érintkezésbe éles peremű alkatrészekkel.
- Az alkatrészeket az ábrák szerint szerelje be.
- Ismét csatlakoztassa az akkumulátort.
- Szerelje vissza a fedőlapokat, ügyeljen arra, hogy a kábelek és a többi alkatrészek pontosan a számukra kijelölt helyen maradjanak.

PL

- Konieczny montaż przez warsztat specjalistyczny.
- Odłączyć przewód masy od akumulatora.
- Dla zapobieżenia uszkodzeniu izolacji chronić przed zetknięciem z ostrymi krawędziami.
- Zamontować części zgodnie z rysunkiem.
- Ponownie podłączyć akumulator.
- Na powrót osadzić osłony; zadbać aby wiązka kablowa i inne części były właściwie i dokładnie ułożone.

EL

- Να τοποθετεί από συνεργείο.
- Αποσυνδέστε το καλώδιο γείωσης από τη μπαταρία.
- Για να αποφευχθούν ζημιές στη μόνωση καλωδίων, να αποφεύγεται η επαφή των με αιχμηρές ακμές.
- Τοποθέτηση των μερών σύμφωνα με τις Εικόνες.
- Συνδέστε πάλι τη μπαταρία.
- Τοποθετήστε πάλι το κάλυμμα-προσοχή, η πλεξούδα καλωδίων και άλλα μέρη να είναι τοποθετημένα ακριβώς και σύμφωνα με τους κανονισμούς.

RU

- Монтаж должны выполнять специалисты в мастерской
- Отсоединить заземляющий кабель аккумулятора
- Во избежание повреждений изоляции кабеля не допускать соприкосания с острыми углами
- Монтировать части согласно иллюстрации
- Снова подключить аккумулятор
- Установить панель, проверить правильность и точность расположения кабелей и других частей









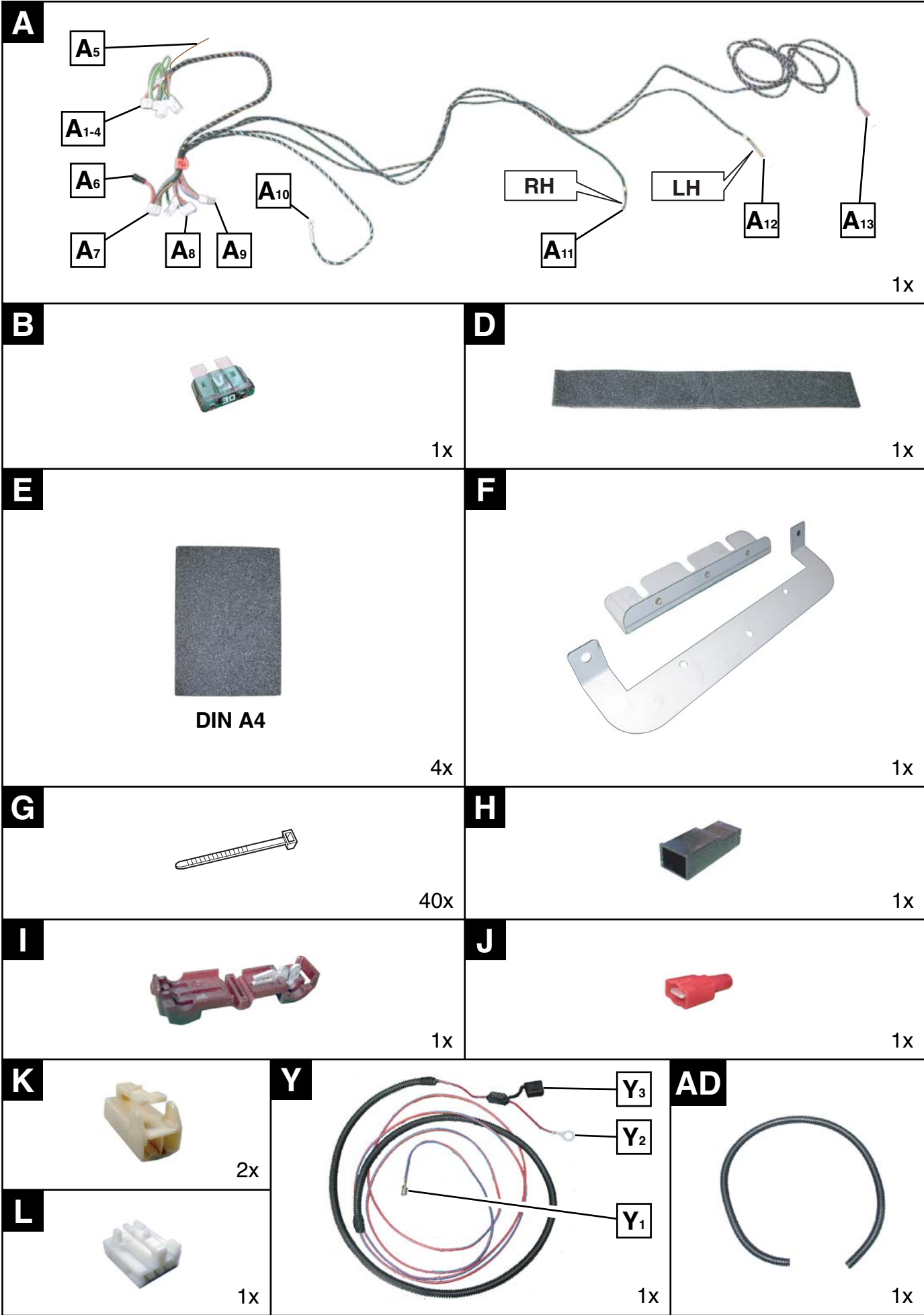

TR



- Uzmanın takması gereklidir .
- Akü toprak kablosunu ayırın.
- Kablo demetinin hasar görmemesi için, sivri objelerle temasını engellenmesini sağlayın.
- Parçaları çizimlerde gösterildiği gibi takın.
- Aküyü tekrar bağlayın.
- Panoları tekrar takın, kablo demeti ve diğer komponentlerin tam ve sıkıca yerleşmesini sağlayın.



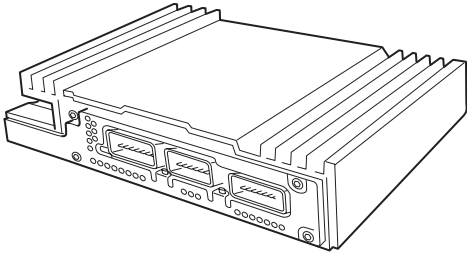



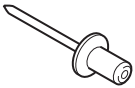



	EN	DE	ES	FR	IT	PT	NL	DA	NO
L	Blue	Blau	Azul	Bleu	Blu	Azul	Blauw	Blå	Blå
B	Black	Schwarz	Negro	Noir	Nero	Preto	Zwart	Sort	Sort
BR	Brown	Braun	Marrón	Marron	Marrone	Castanho	Bruin	Brun	Brun
DL	Dark blue	Dunkelblau	Azul oscuro	Bleu foncé	Blu scuro	Azul-escuro	Donkerblauw	Mørkeblå	Mørkeblå
DG	Dark green	Dunkelgrün	Verde oscuro	Vert foncé	Verde scuro	Verde-escuro	Donkergroen	Mørkegrøn	Mørkegrønn
G	Green	Grün	Verde	Vert	Verde	Verde	Groen	Grøn	Grønn
GR	Grey	Grau	Gris	Gris	Grigio	Cinzento	Grijs	Grå	Grå
LB	Light blue	Hellblau	Azul claro	Bleu clair	Blu chiaro	Azul-claro	Lichtblauw	Lyseblå	Lyseblå
LG	Light green	Hellgrün	Verde claro	Vert clair	Verde chiaro	Verde-claro	Lichtgroen	Lysegrøn	Lysegrønn
NO	Natural colour	Naturfarben	Color natural	Nature	Colori naturali	Cores naturais	Naturel	Naturfarvet	Naturfarger
O	Orange	Orange	Naranja	Orange	Arancione	Laranja	Oranje	Orange	Orange
P	Pink	Rosa	Rosa	Rose	Rosa	Rosa	Rosé	Rosa	Rosa
R	Red	Rot	Rojo	Rouge	Rosso	Vermelho	Rood	Rød	Rød
PU	Purple	Purpur	Púrpura	Pourpre	Rosso porpora	Púrpura	Paars	Purpur	Purpur
SB	Sky blue	Himmelblau	Azul cielo	Bleu ciel	Celeste	Azul-céu	Hemelsblauw	Himmelblå	Himmelblå
T	Yellow brown	Gelbbraun	Amarillo-marrón	Marron-jaune	Giallomarrone	C a s t a n h o - amarelado	Geelbruin	Gulbrun	Gulbrun
W	White	Weiß	Blanco	Blanc	Bianco	Branco	Wit	Hvid	Hvit
Y	Yellow	Gelb	Amarillo	Jaune	Giallo	Amarelo	Geel	Gul	Gul
V	Violet	Violett	Violeta	Violet	Viola	Violeta	Violet	Violet	Fiolett

	SV	FI	CS	HU	PL	EL	RU	TR
L	Blå	Sininen	Modrá	Kék	Niebieska	Μπλε	Синий	Mavi
B	Svart	Musta	Černá	Fekete	Czarna	Μαύρο	Чёрный	Siyah
BR	Brun	Ruskea	Hnědá	Barna	Brazowa	Καφέ	Коричневый	Kahverengi
DL	Mörkblå	Tummansininen	Tmavomodrá	Sötétkék	Granatowa	Σκούρο μπλε	Тёмно-синий	Koyu mavi
DG	Mörkgrön	Tummanvihreä	Tmavozelená	Sötétzöld	Ciemnozielona	Σκούρο πράσινο	Тёмно-зелёный	Koyu yesil
G	Grön	Vihreä	Zelená	Zöld	Zielona	Πράσινο	Зелёный	Yeşil
GR	Grå	Harmaa	Šedá	Szürke	Szara	Γκρι	Серый	Gri
LB	Ljusblå	Vaaleansininen	Bleděmodrá	Világoskék	Jasnoniebieska	Ανοικτό μπλε	Голубой	Acik mavi
LG	Ljusgrön	Vaaleanvihreä	Světlezelená	Világoszöld	Jasnozielona	Ανοικτό πράσινο	Светло-зелёный	Acik yesil
NO	Naturfärger	Luonnonväri	Přírodní barva	Természeti színű	Barwy naturalne	Φυσικά χρώματα	Телесный	Naturel
O	Orange	Oranssi	Oranžová	Narancs	Pomarańczowa	Πορτοκαλί	Оранжевый	Turuncu
P	Rosa	Rosa	Růžová	Rózsaszín	Różowa	Ροζ	Розовый	Pembe
R	Röd	Punainen	Červená	Piros	Czerwona	Κόκκινο	Красный	Kırmızı
PU	Purpur	Purppura	Purpurová	Bíborvörös	Purpurowa	Πορφυρό	Пурпурный	Mor
SB	Himmelsblå	Taivaansininen	Blankytá	Égyszínű	Bękitna	Γαλάζιο	Небесно-голубой	Gök mavisi
T	Gulbrun	Keltaisenruskea	Žlutohnědá	Sárgásbarna	Żółtobrazowa	Κίτρινοκαφέ	Жёлто-коричневый	Sarı kahverengi
W	Vit	Valkoinen	Bílá	Fehér	Biała	Λευκό	Белый	Beyaz
Y	Gul	Keltainen	Žlutá	Sárga	Żółta	Κίτρινο	Жёлтый	Sarı
V	Violett	Violett	Fialová	Ibolyakék	Fioletowa	Μοβν	Фиолетовый	Menekşe

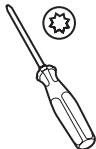
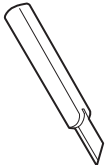

<p>O</p>  <p>2x</p>	<p>P</p>  <p>2x</p>	<p>Q</p>  <p>1x</p>	<p>R</p>  <p>2x</p>
<p>S</p>  <p>6x</p>	<p>T</p>  <p>M5 6x</p>	<p>U</p>  <p>6x</p>	<p>V</p>  <p>1x</p>
<p>X</p>  <p>1x</p>			<p>W</p>  <p>1x</p>

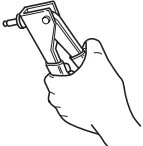
<p>Z 64033-42010-B0</p>  <p>1x</p>	<p>AA 90269-05034</p>  <p>16x</p>	<p>AB PZ438-00230-00</p>  <p>5x</p>	<p>AC 90467-09203</p>  <p>5x</p>
--	---	--	--

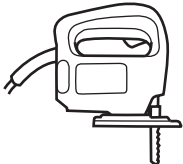
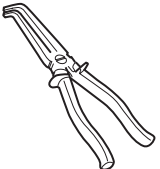
				
				
	<p>ISOPROPANOL</p> 	 <p>Ø 4 mm Ø 7 mm</p>		

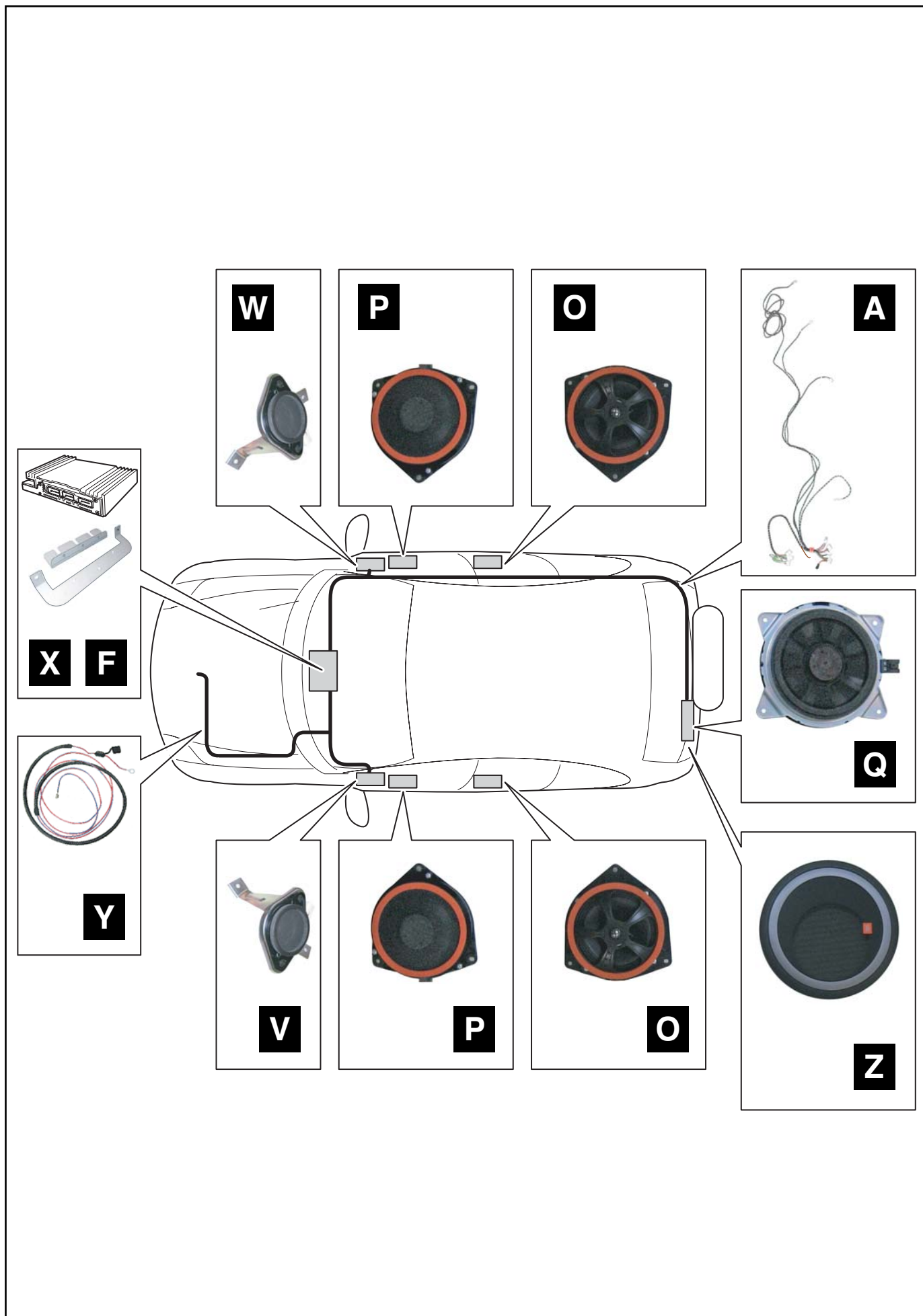

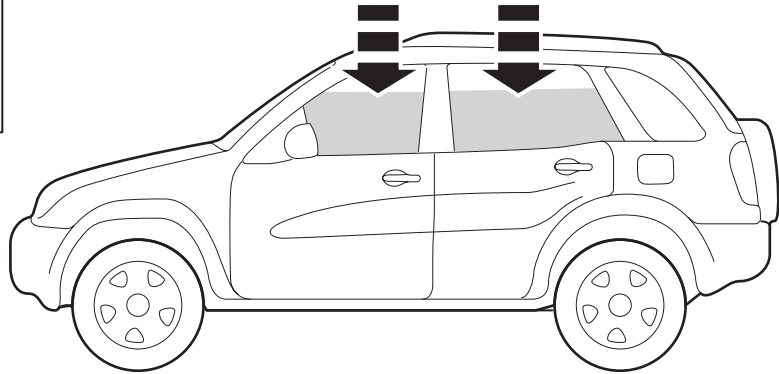
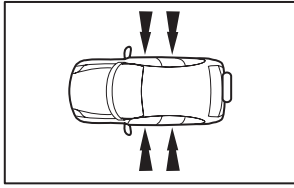

1

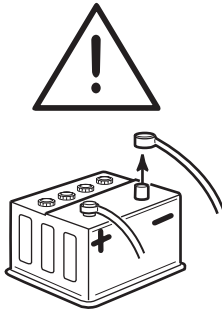

2



3

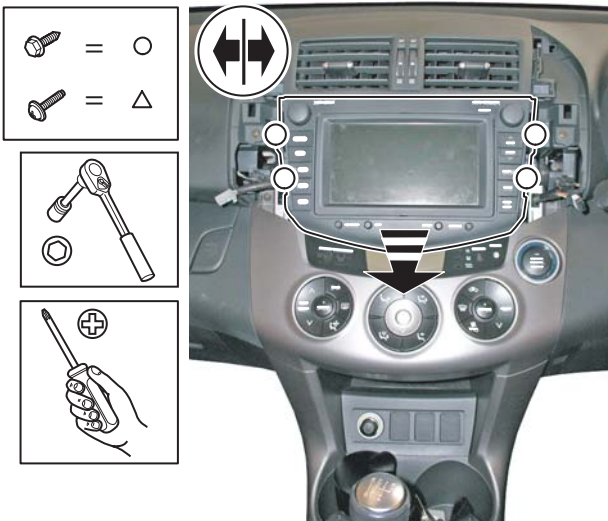

4

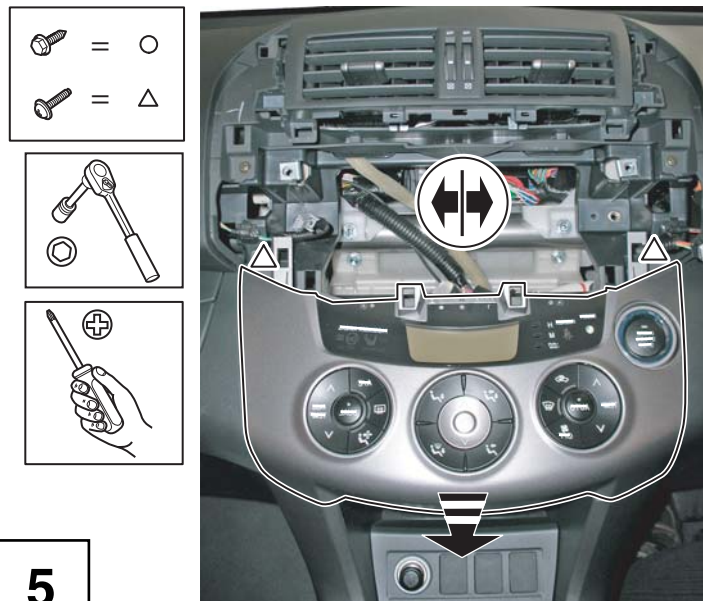

5

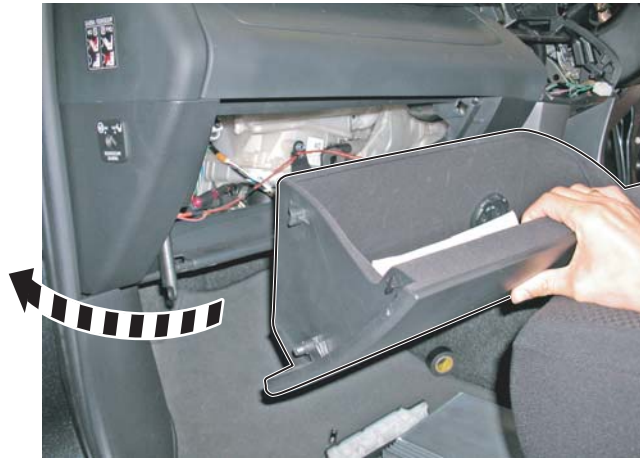

6

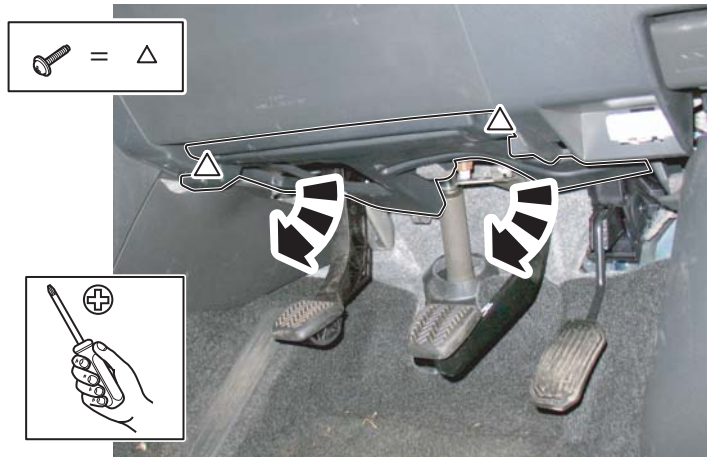

7

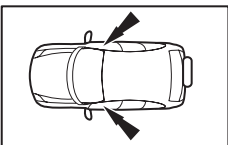

8

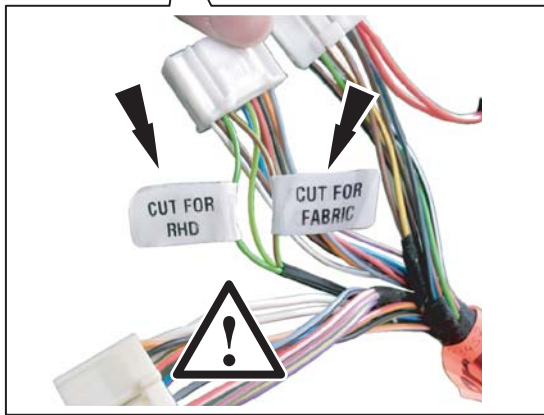
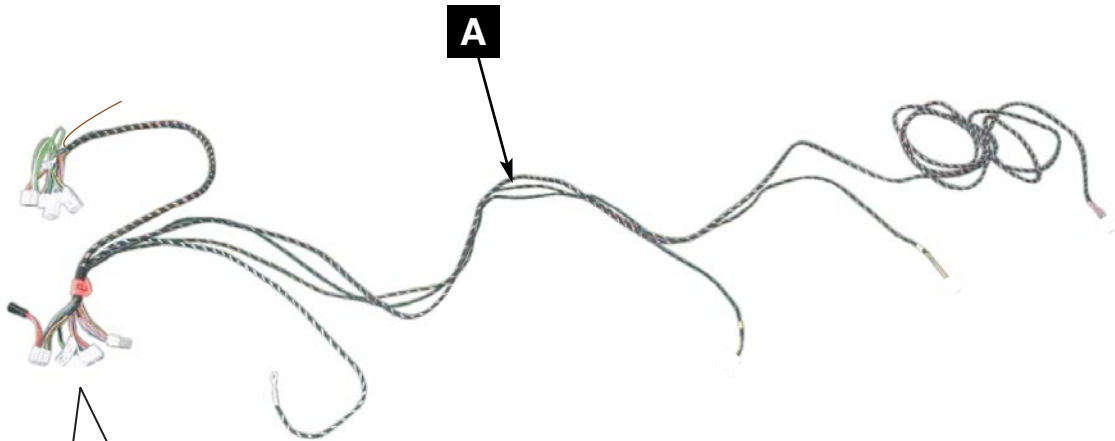

9

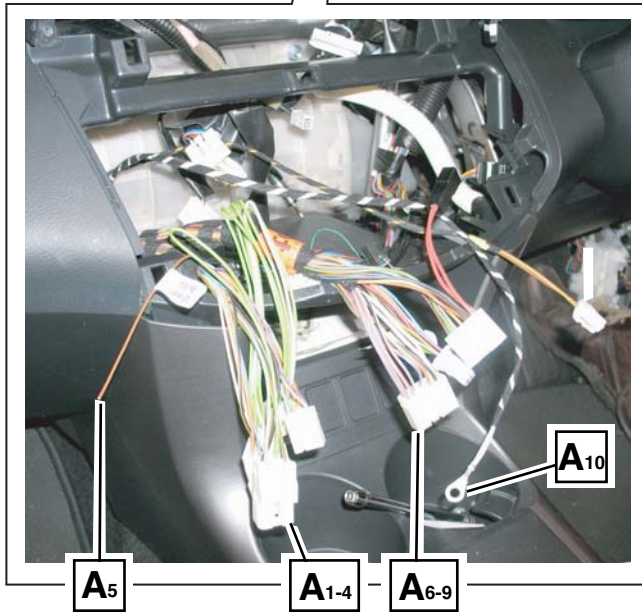
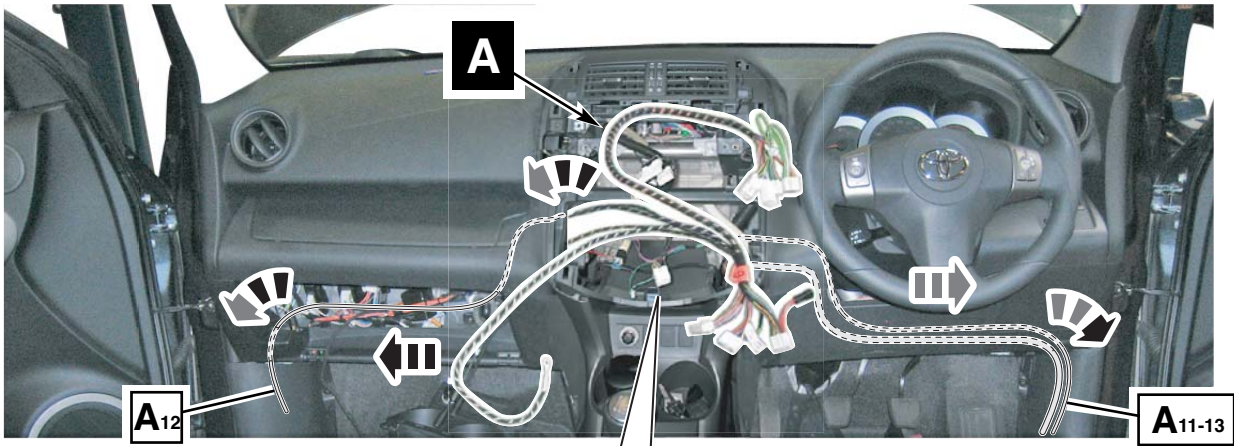

10

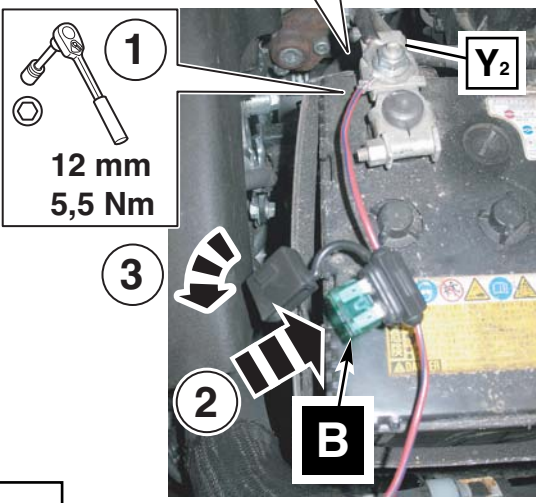
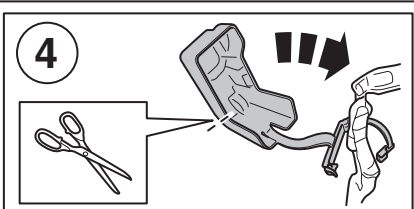

11

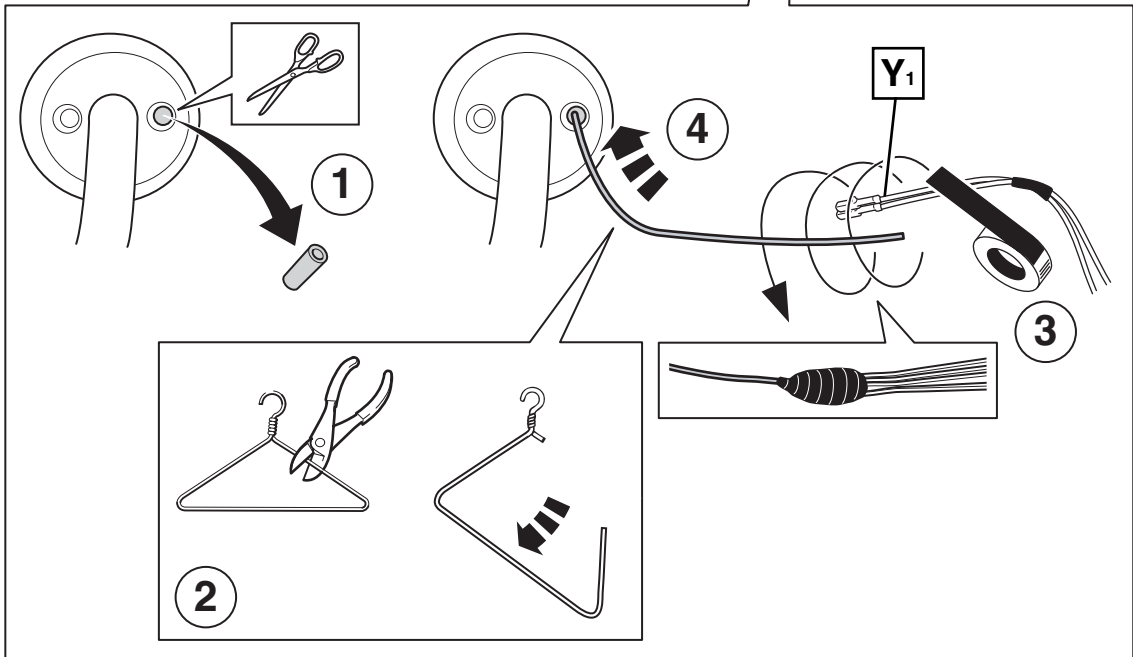
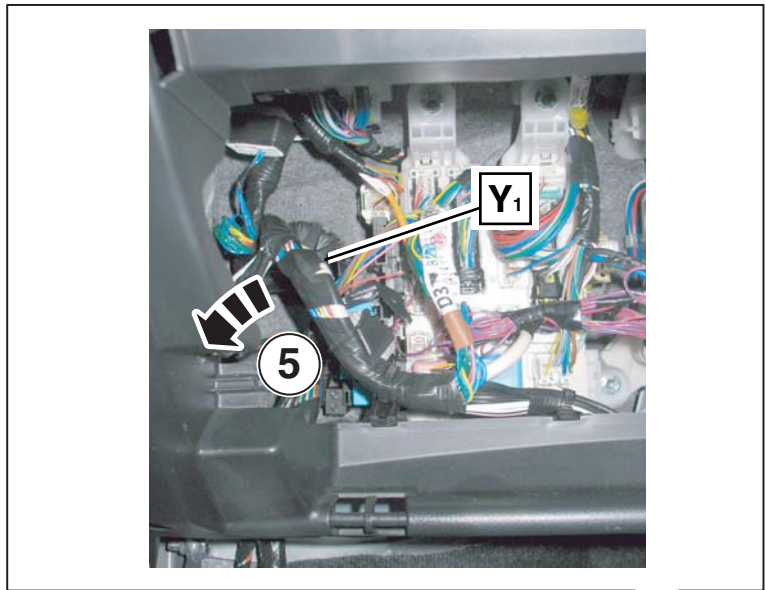

12

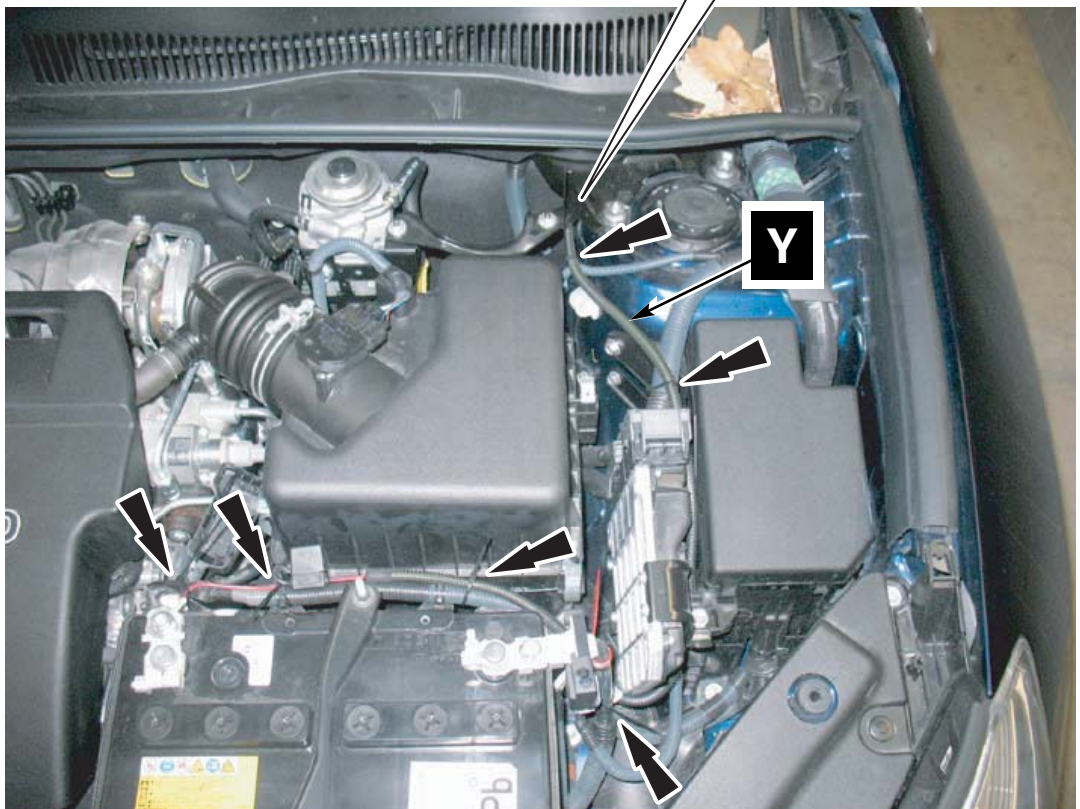
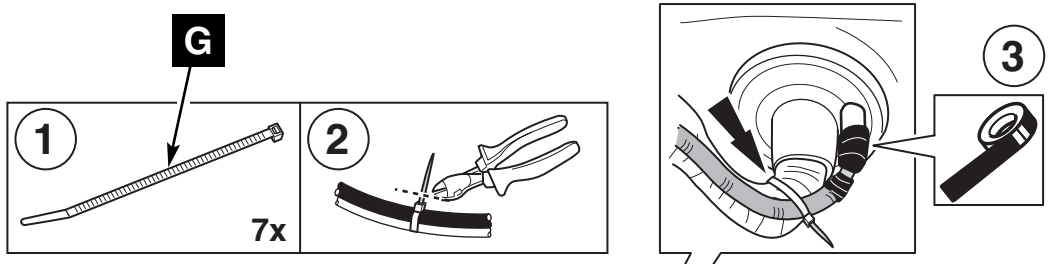

13

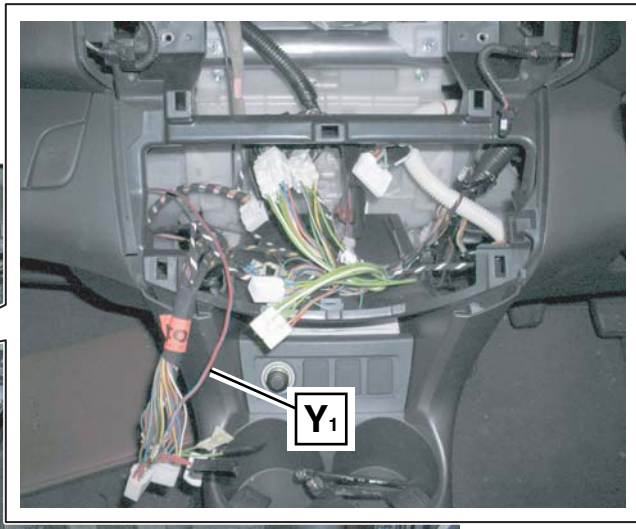
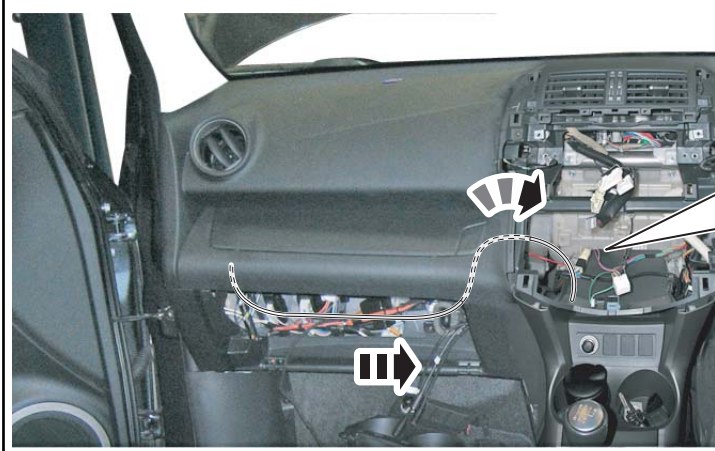

14

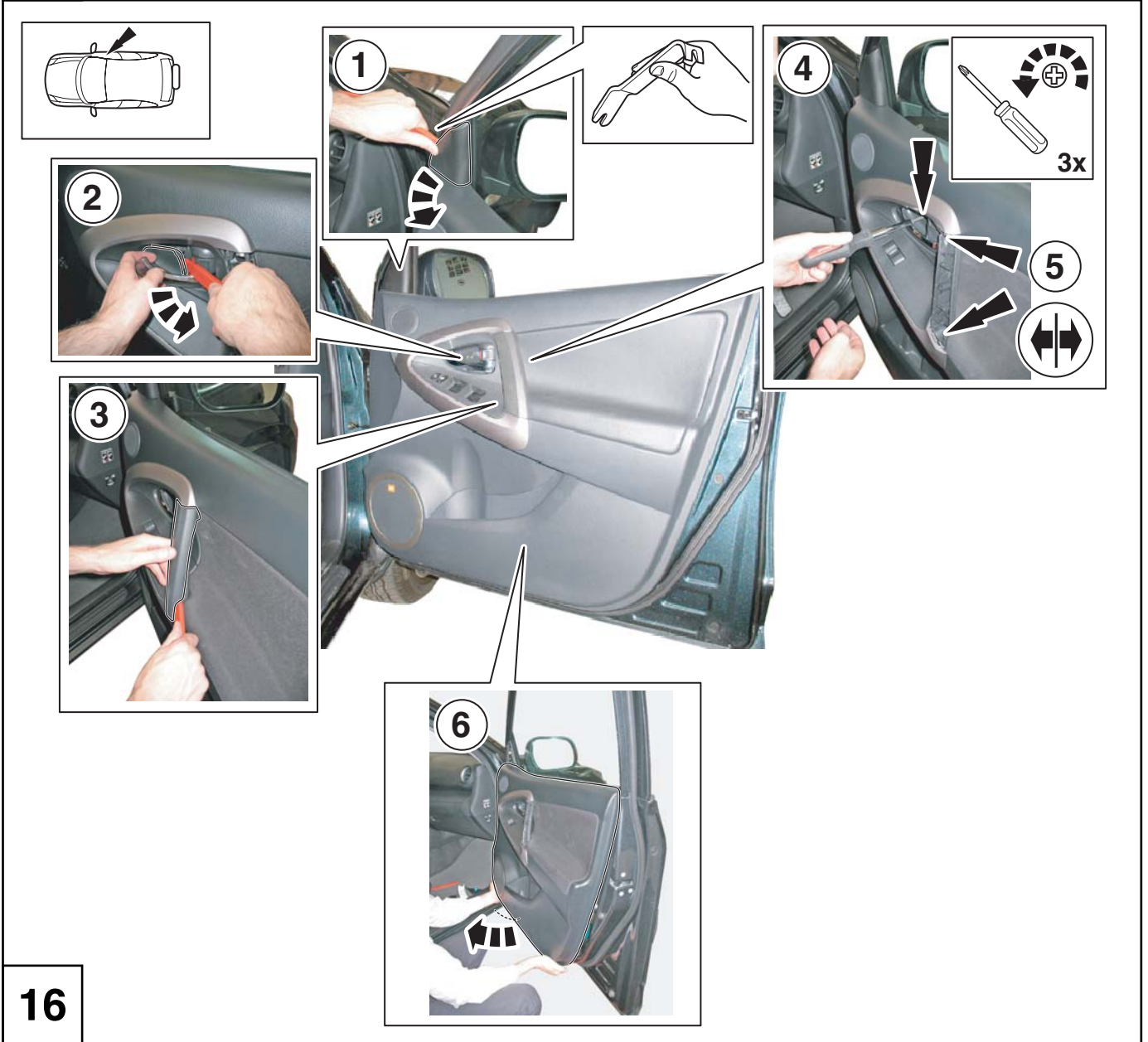
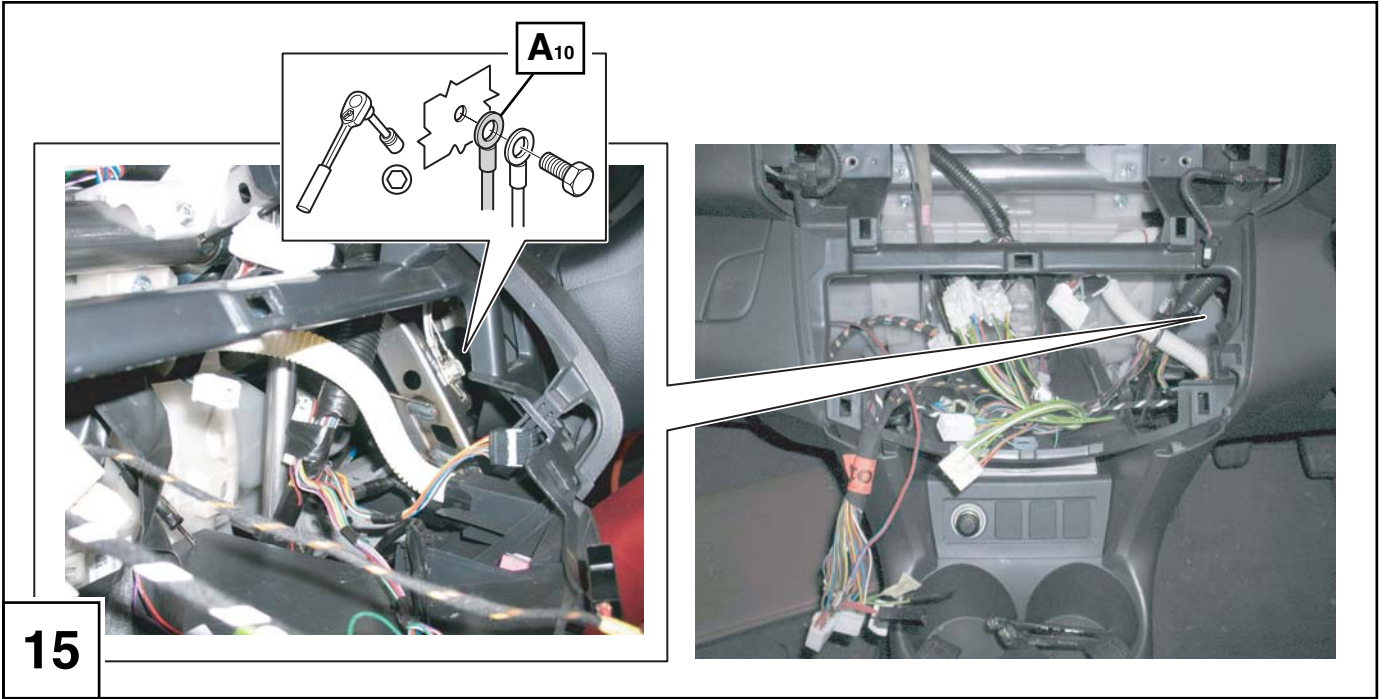

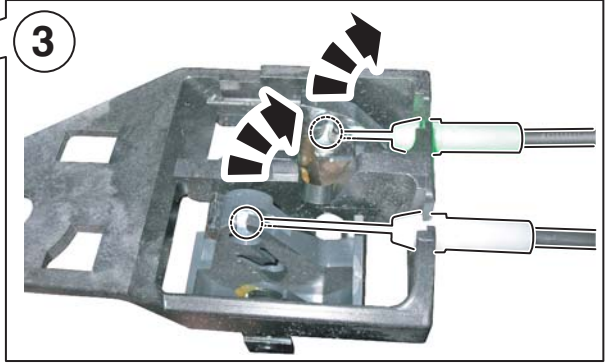
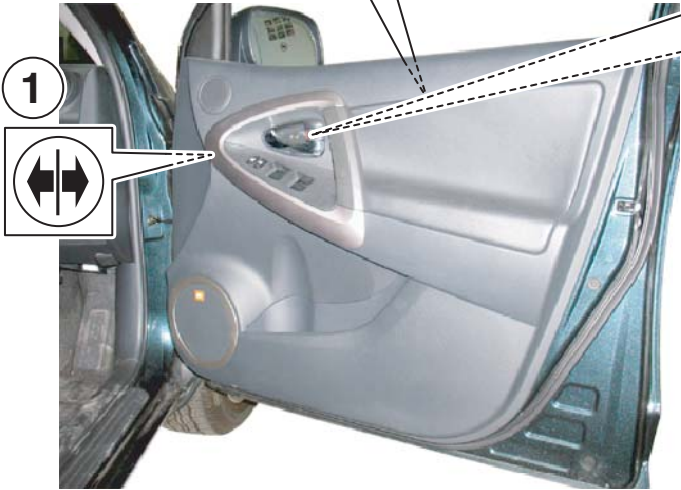
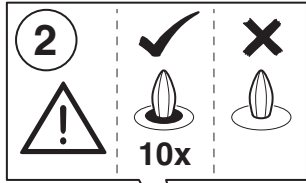
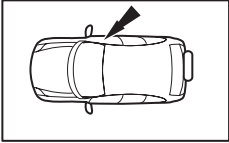

17

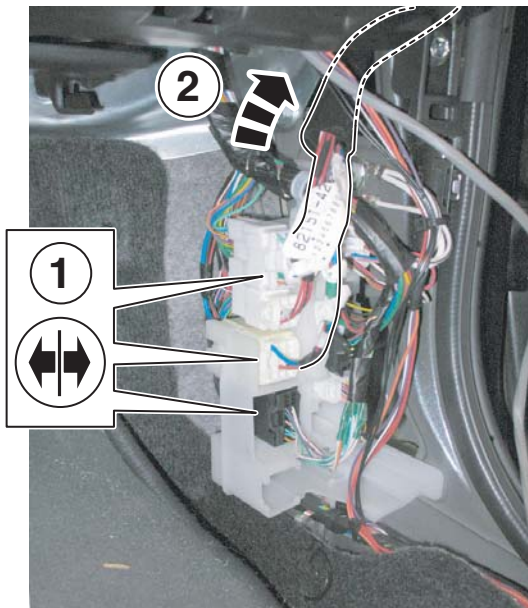
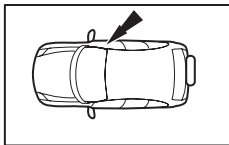

18

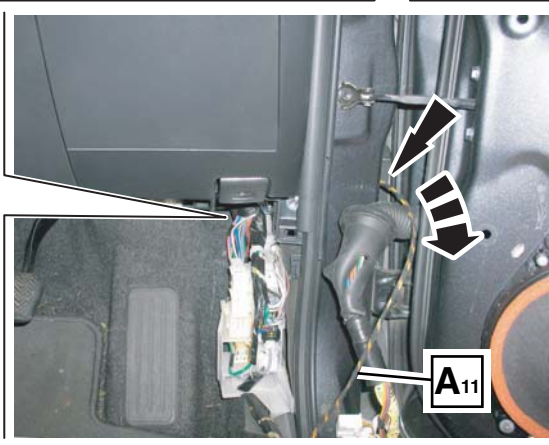
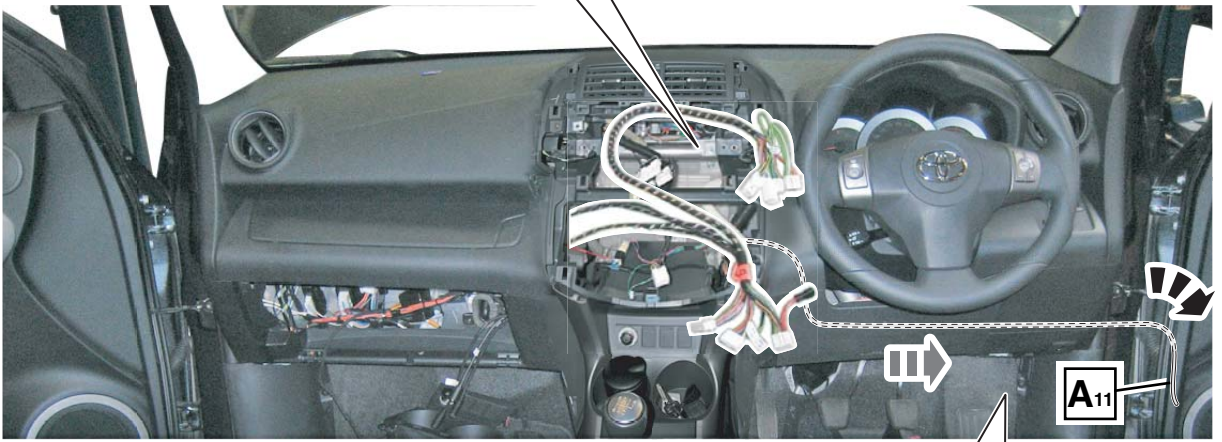
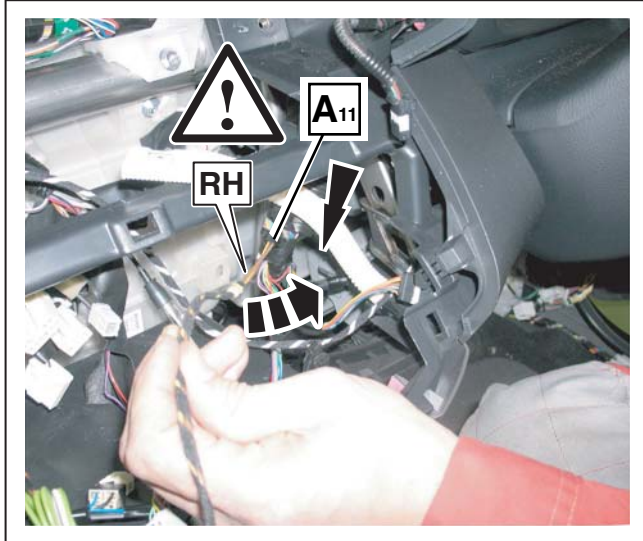
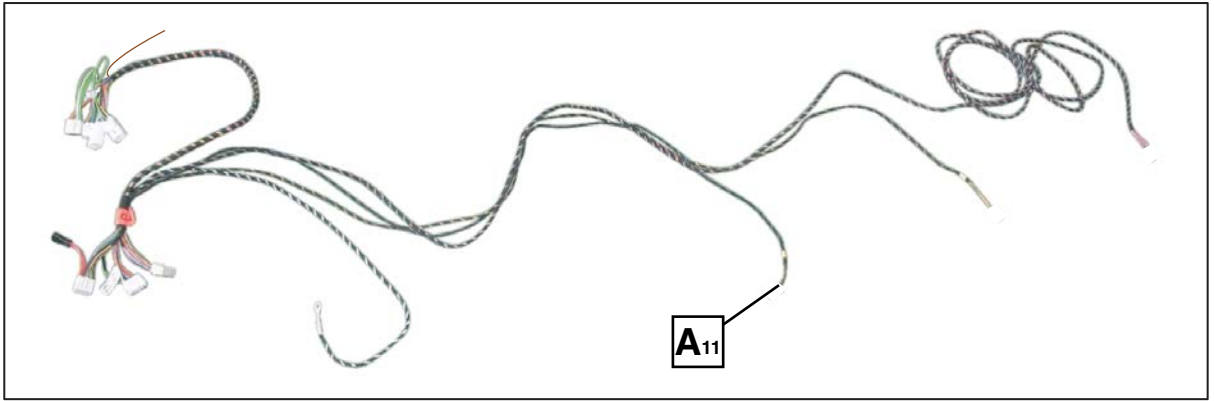

19

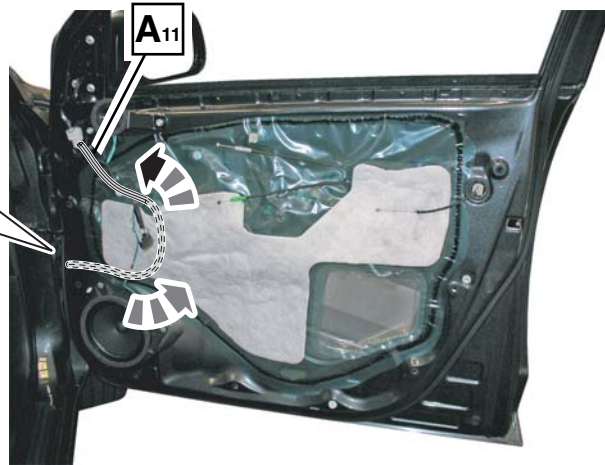
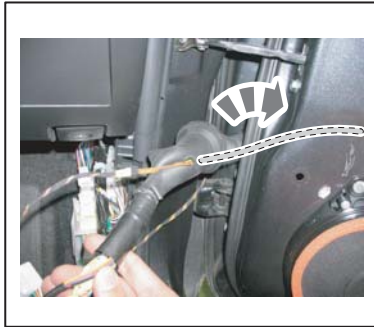
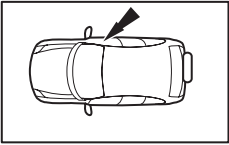

20

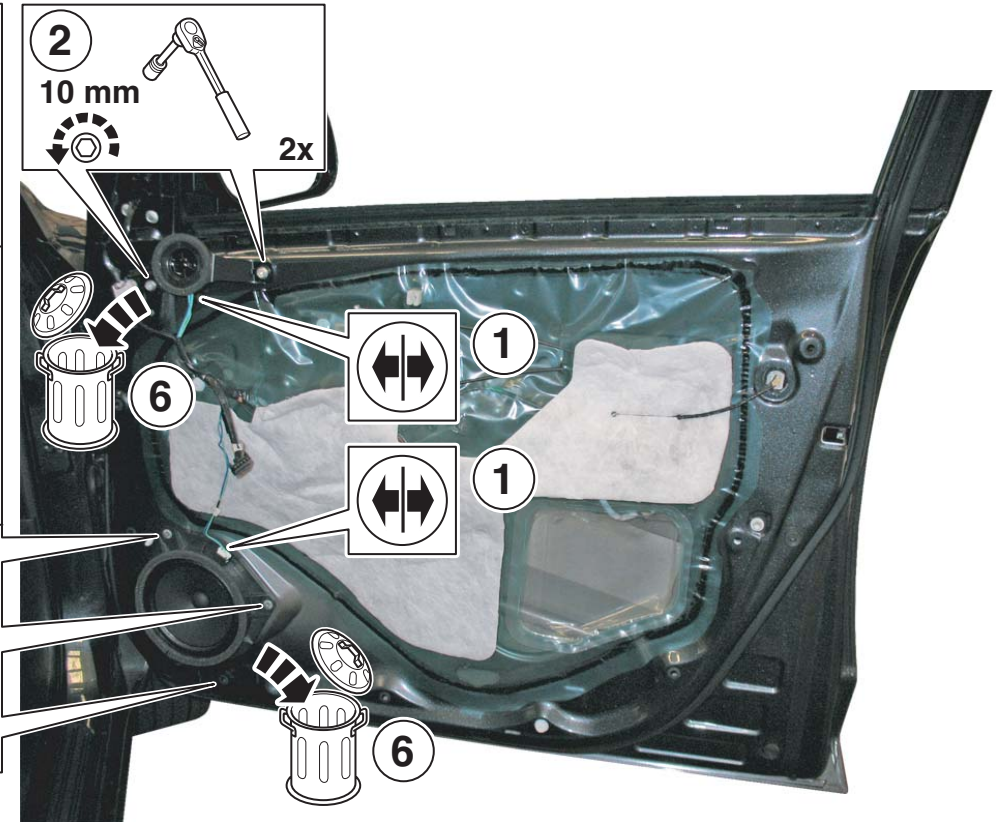
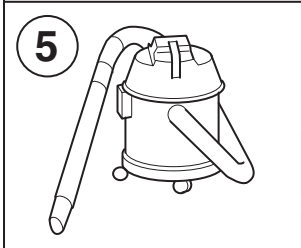
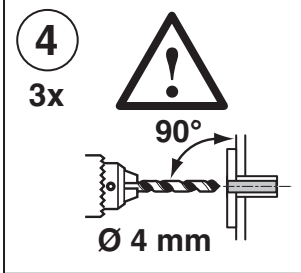
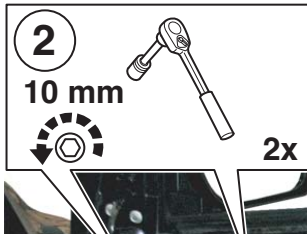
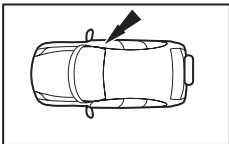

21

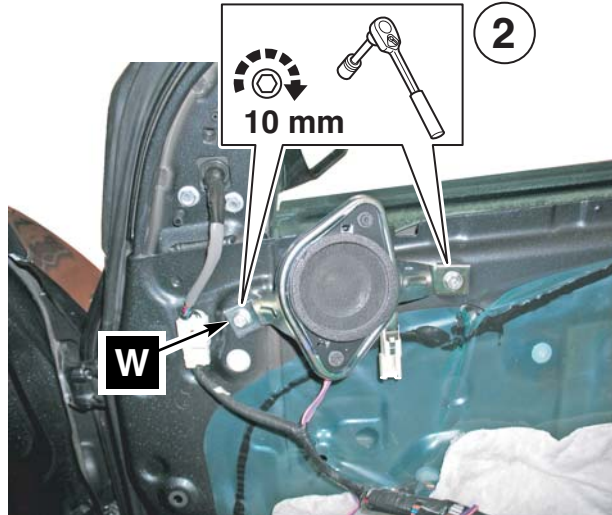
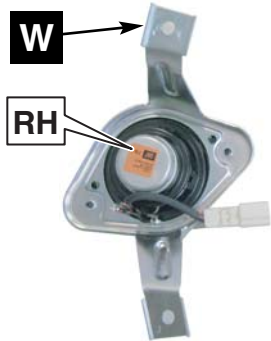
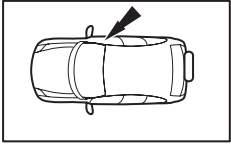

22

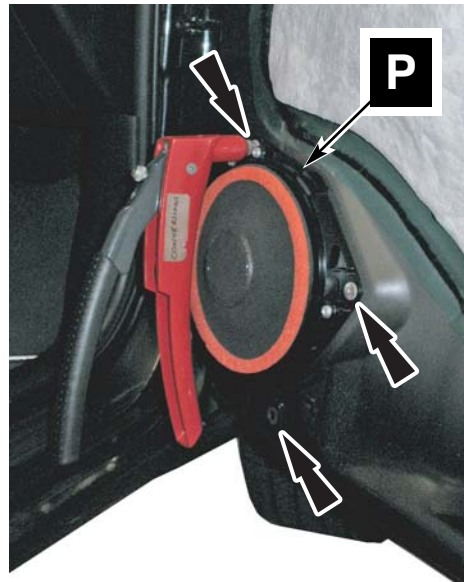
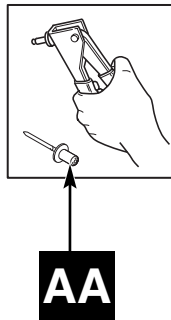
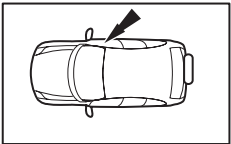

23

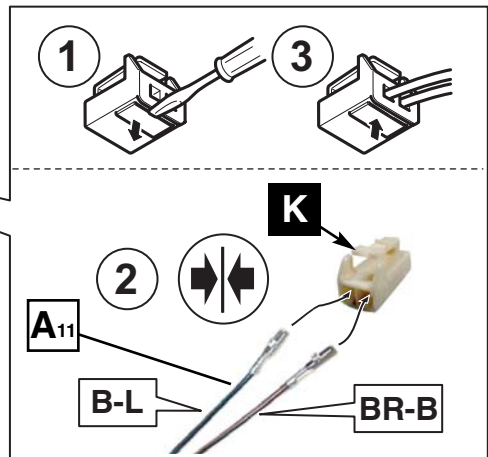
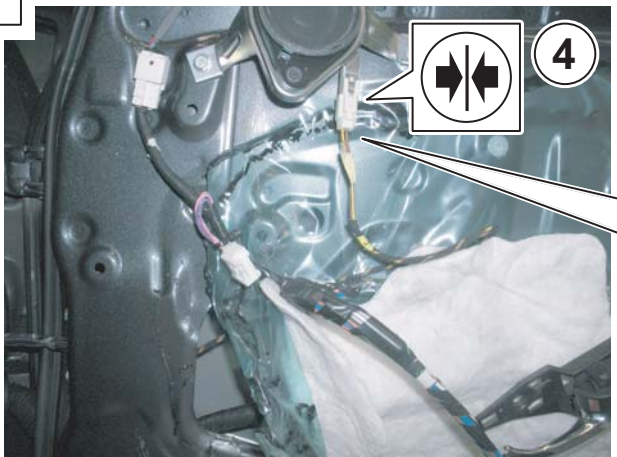
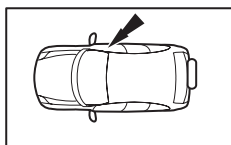

24

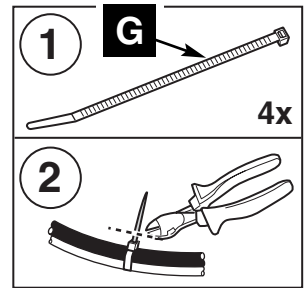
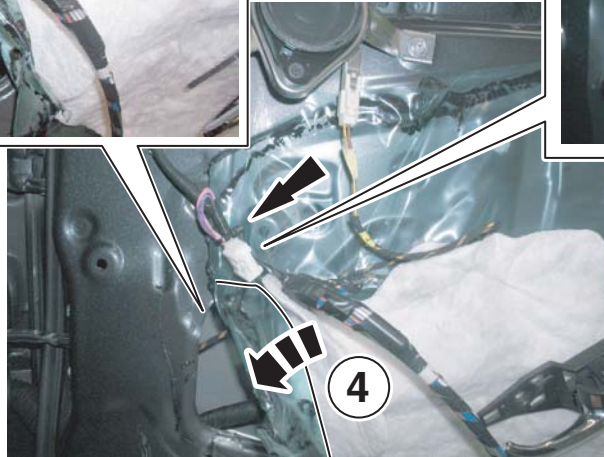
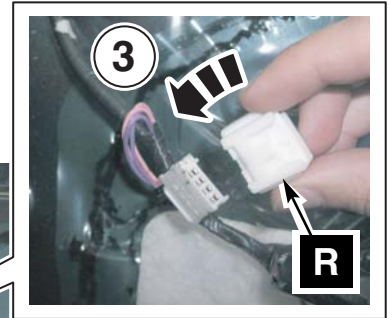
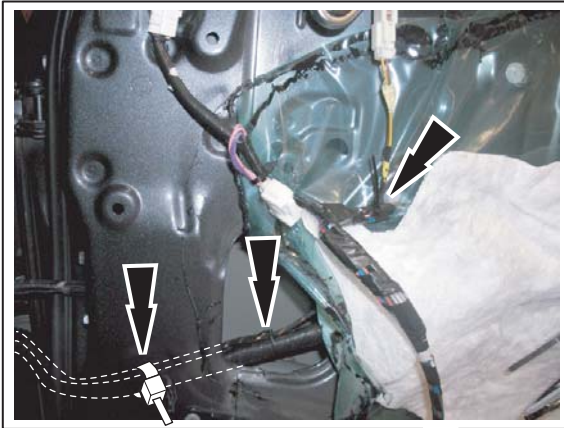
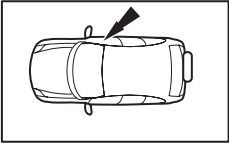

25

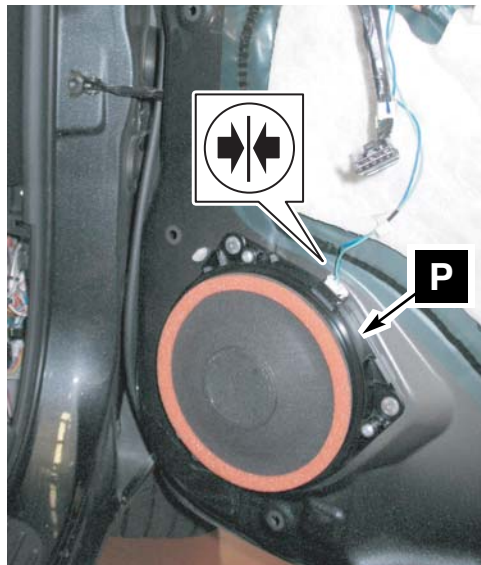
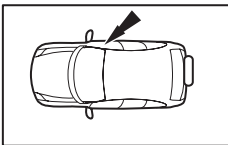

26

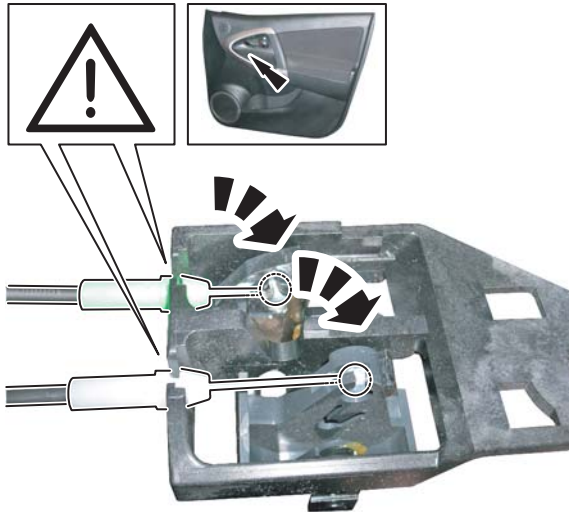
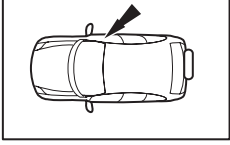

27

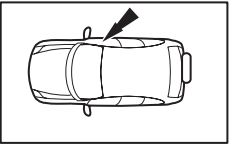

28

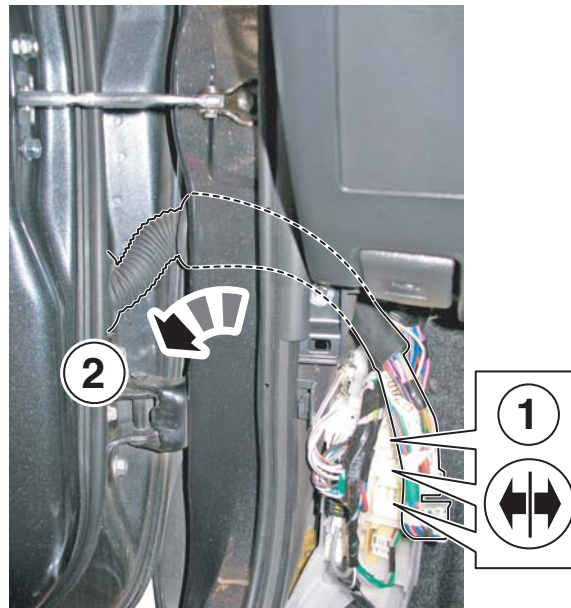
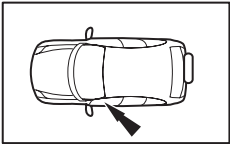

29

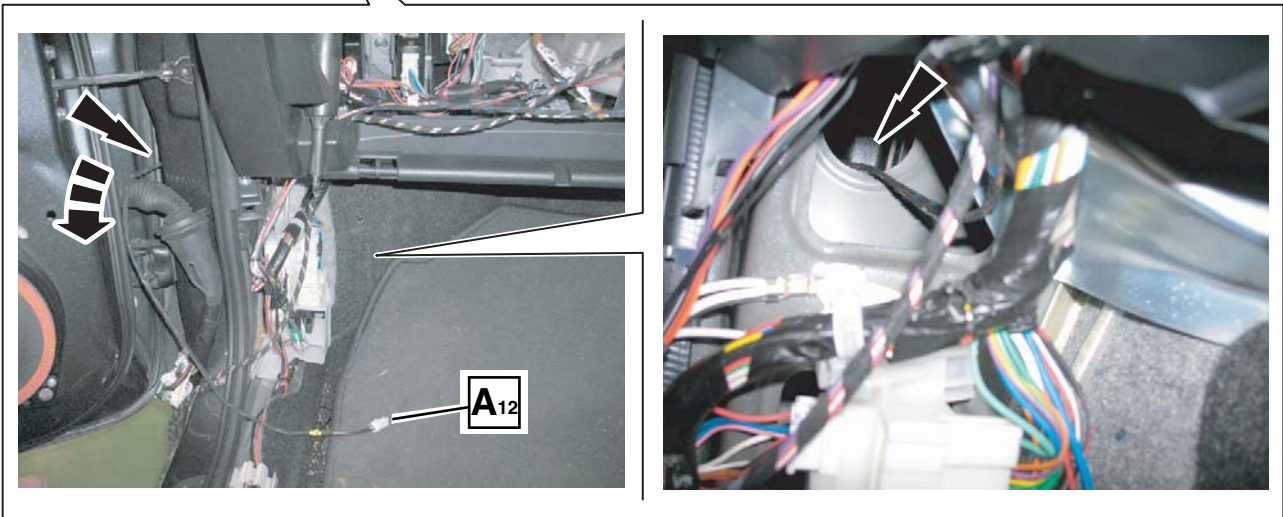
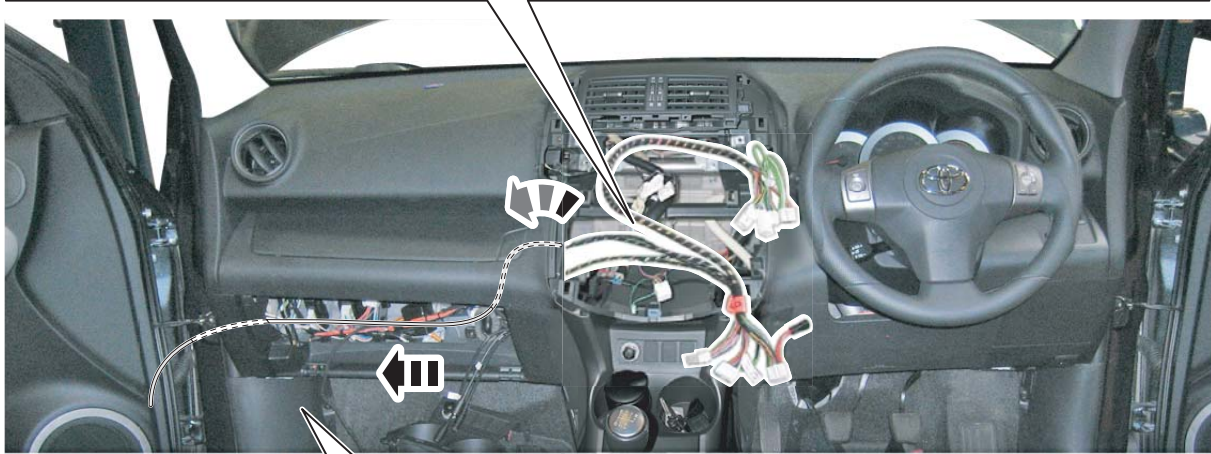
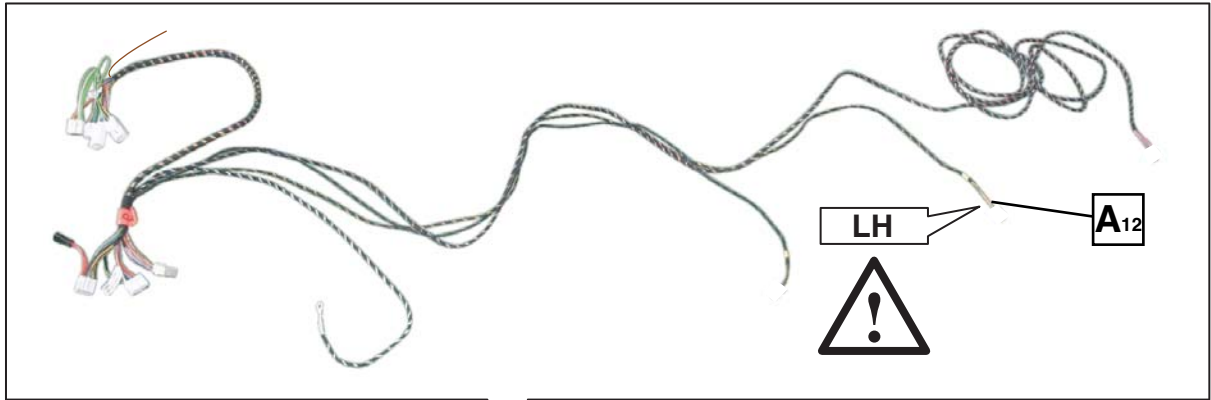

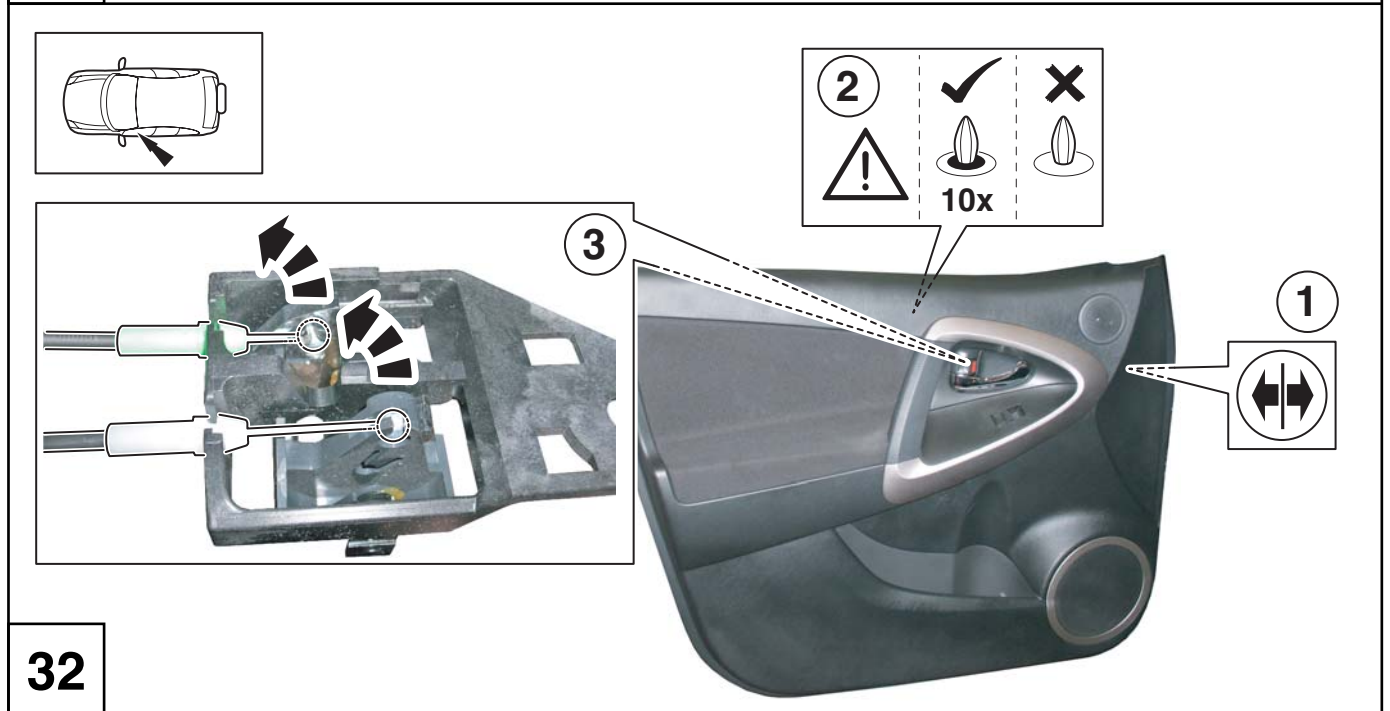
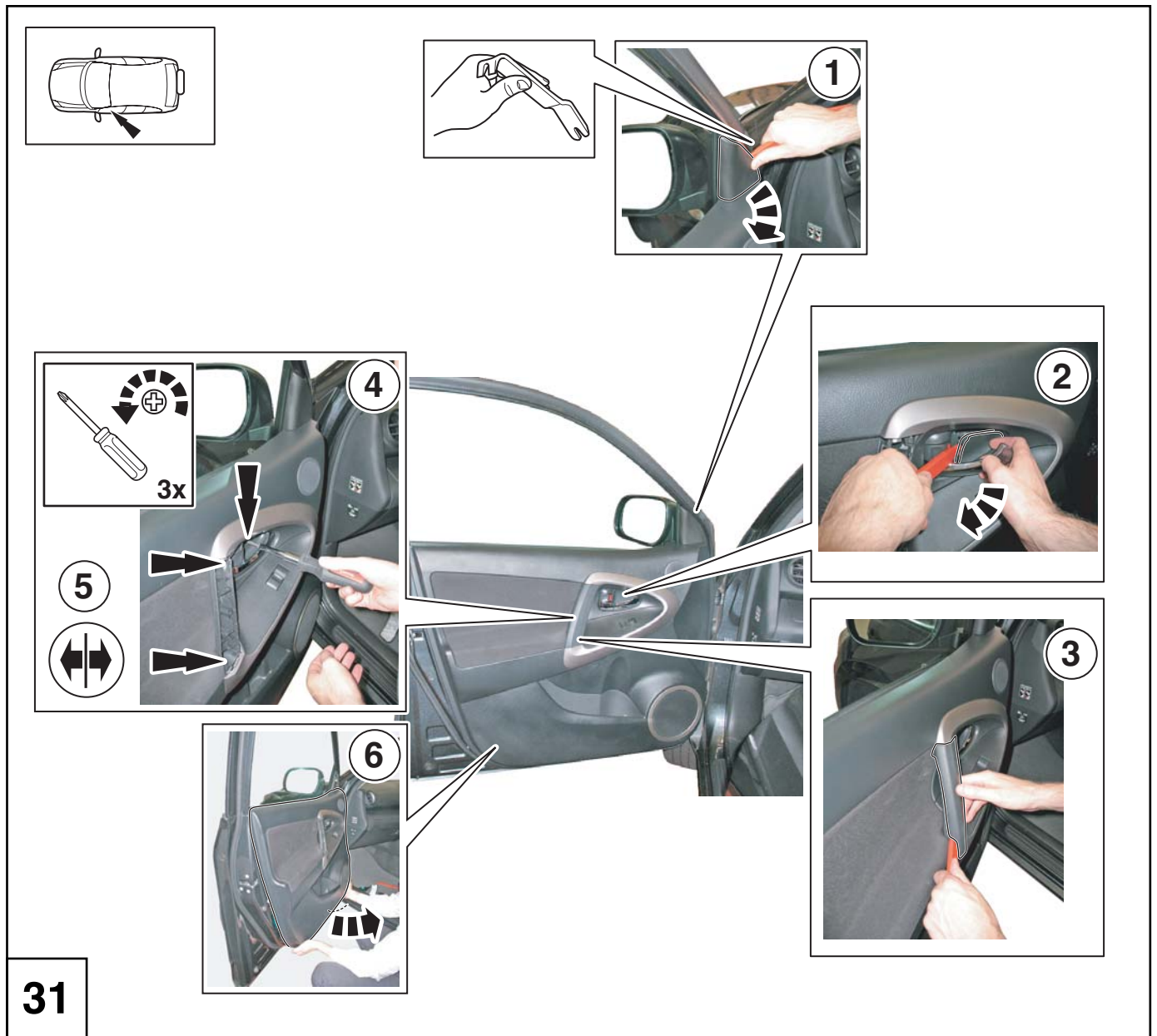

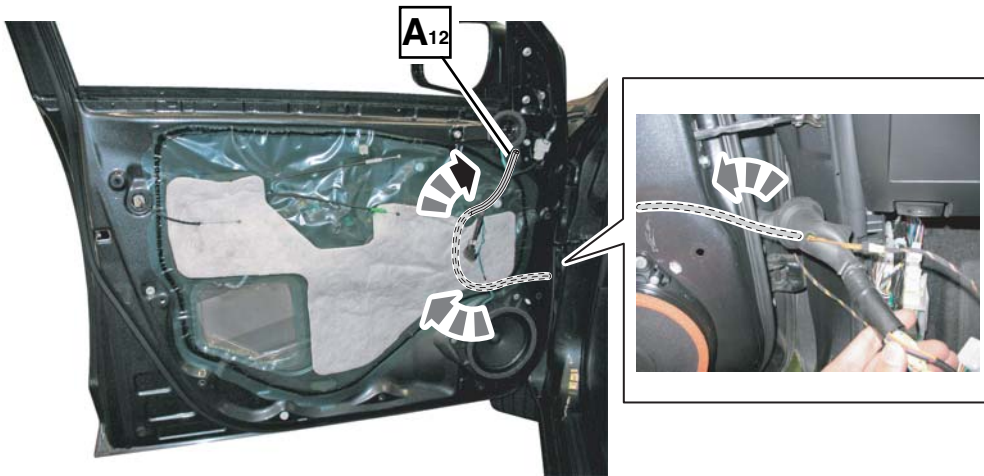
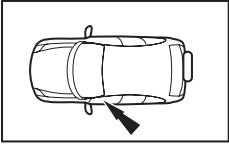

33

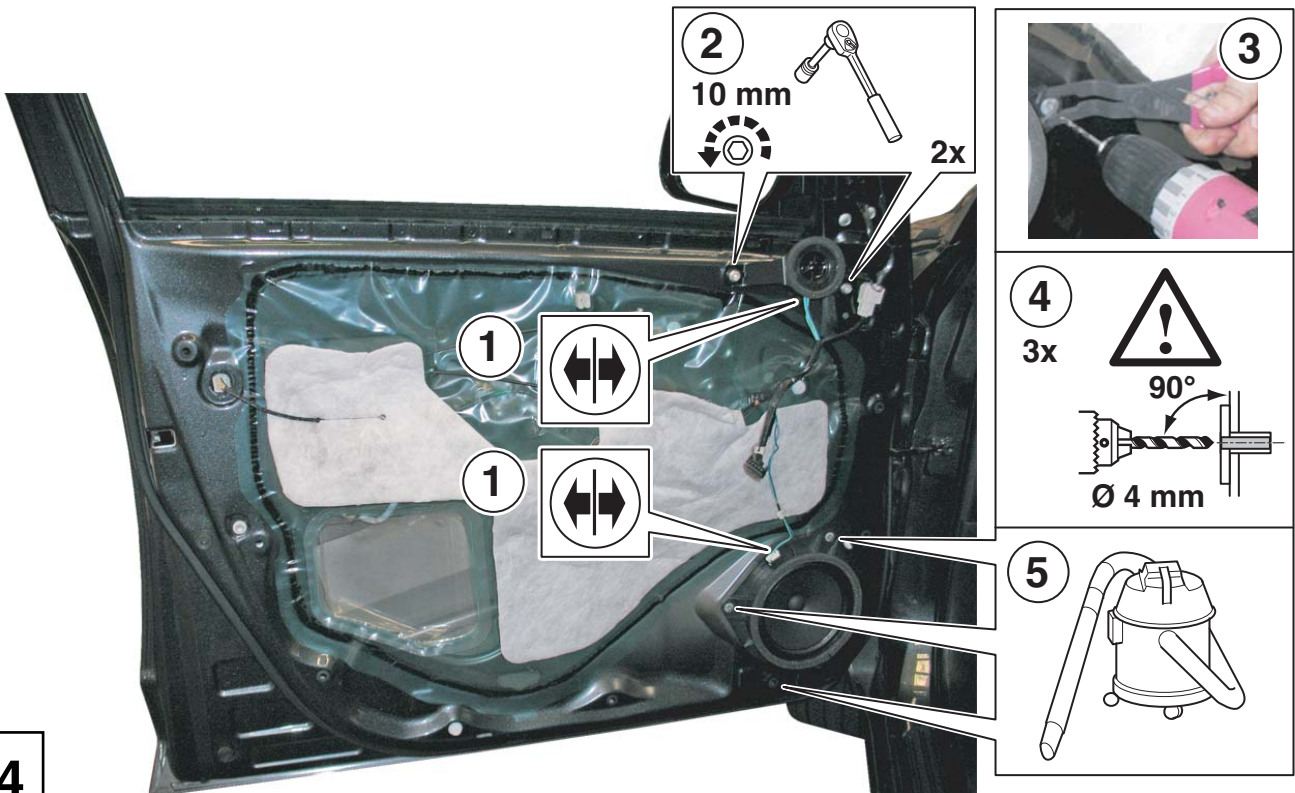
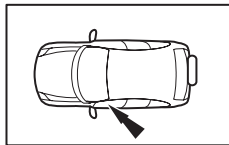

34

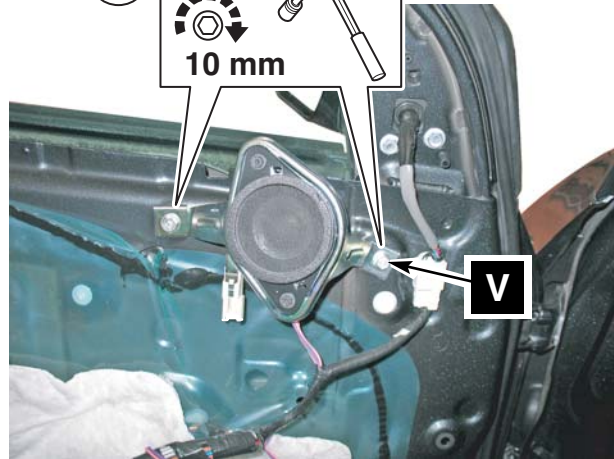
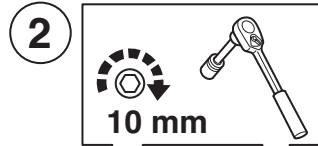
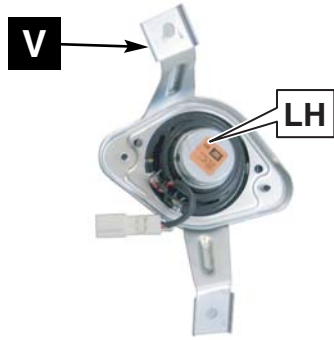
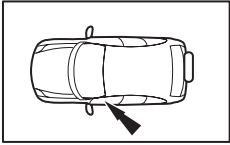

35

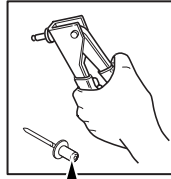
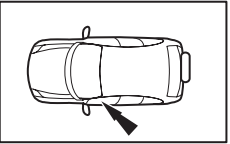

AA

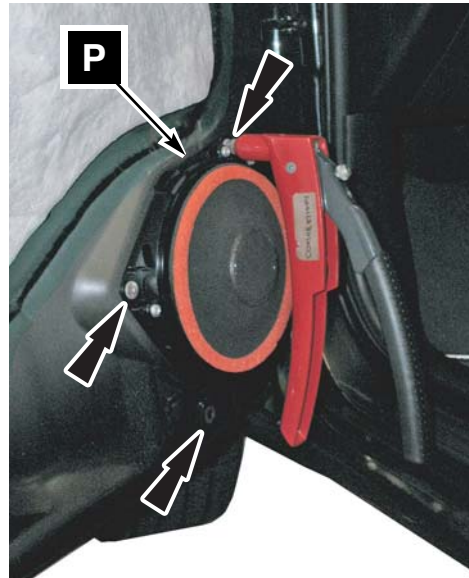

36

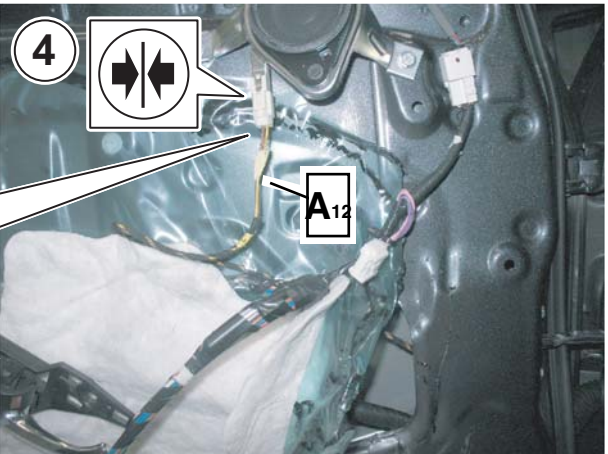
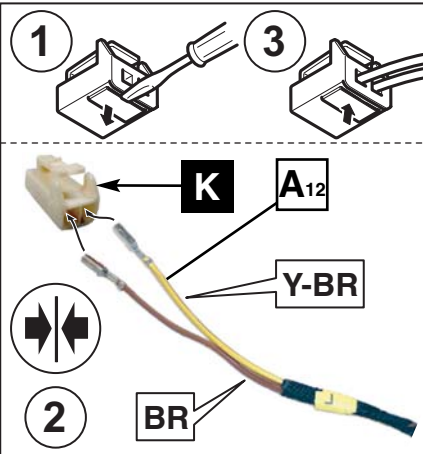
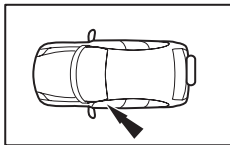

37

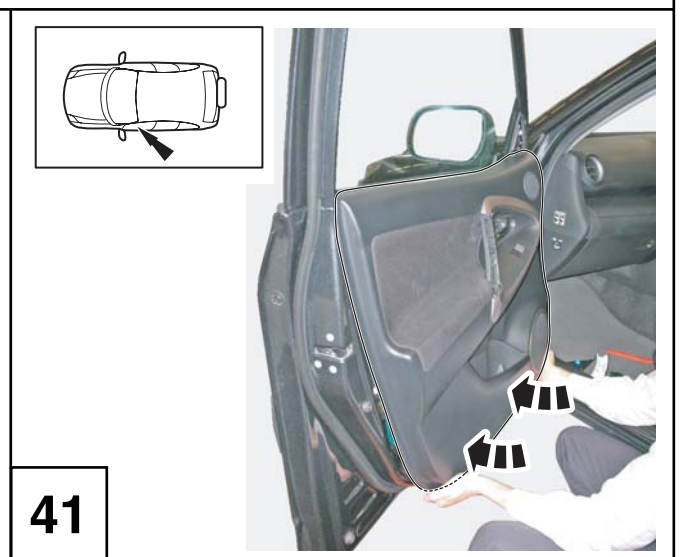
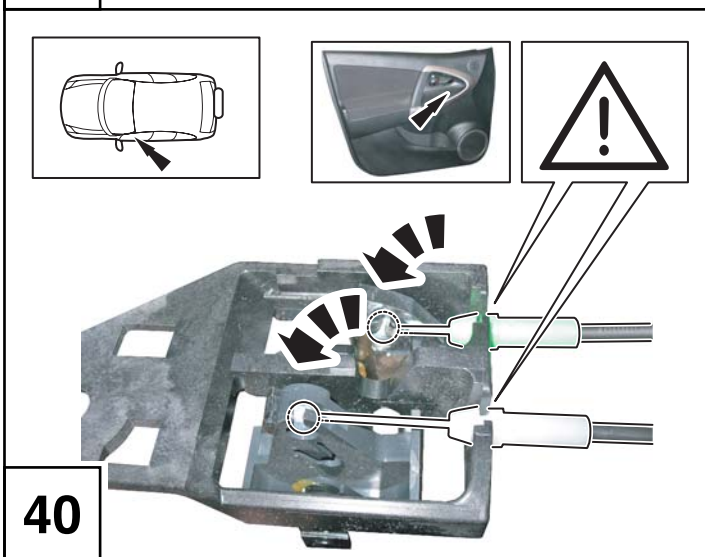
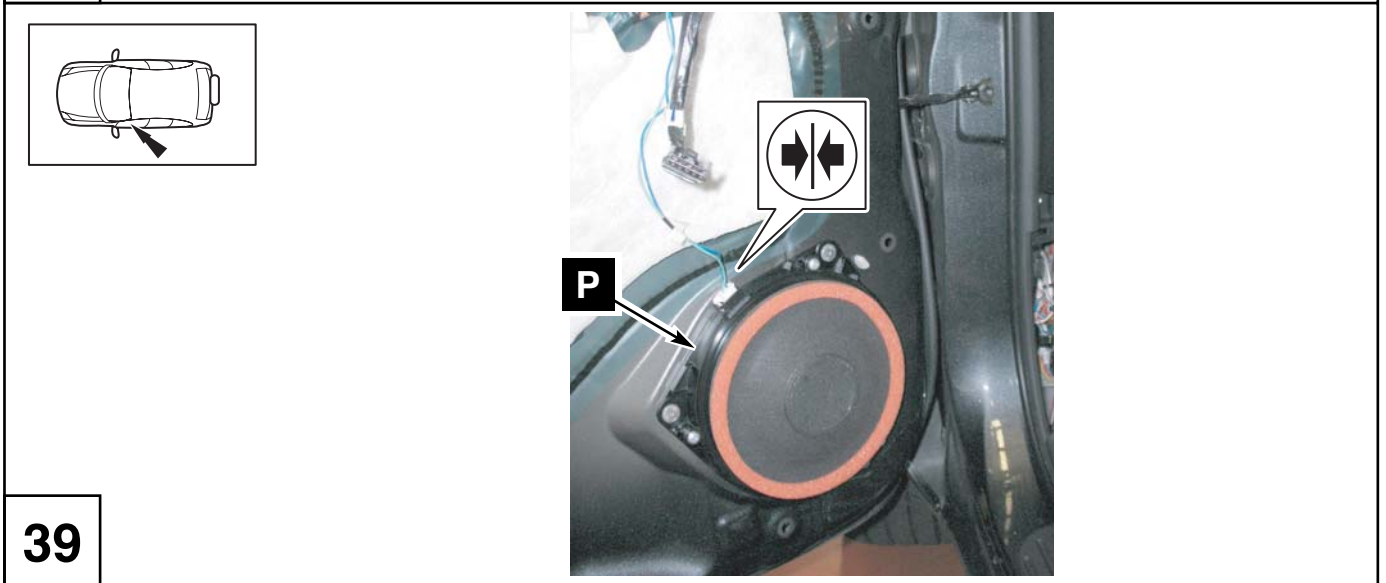
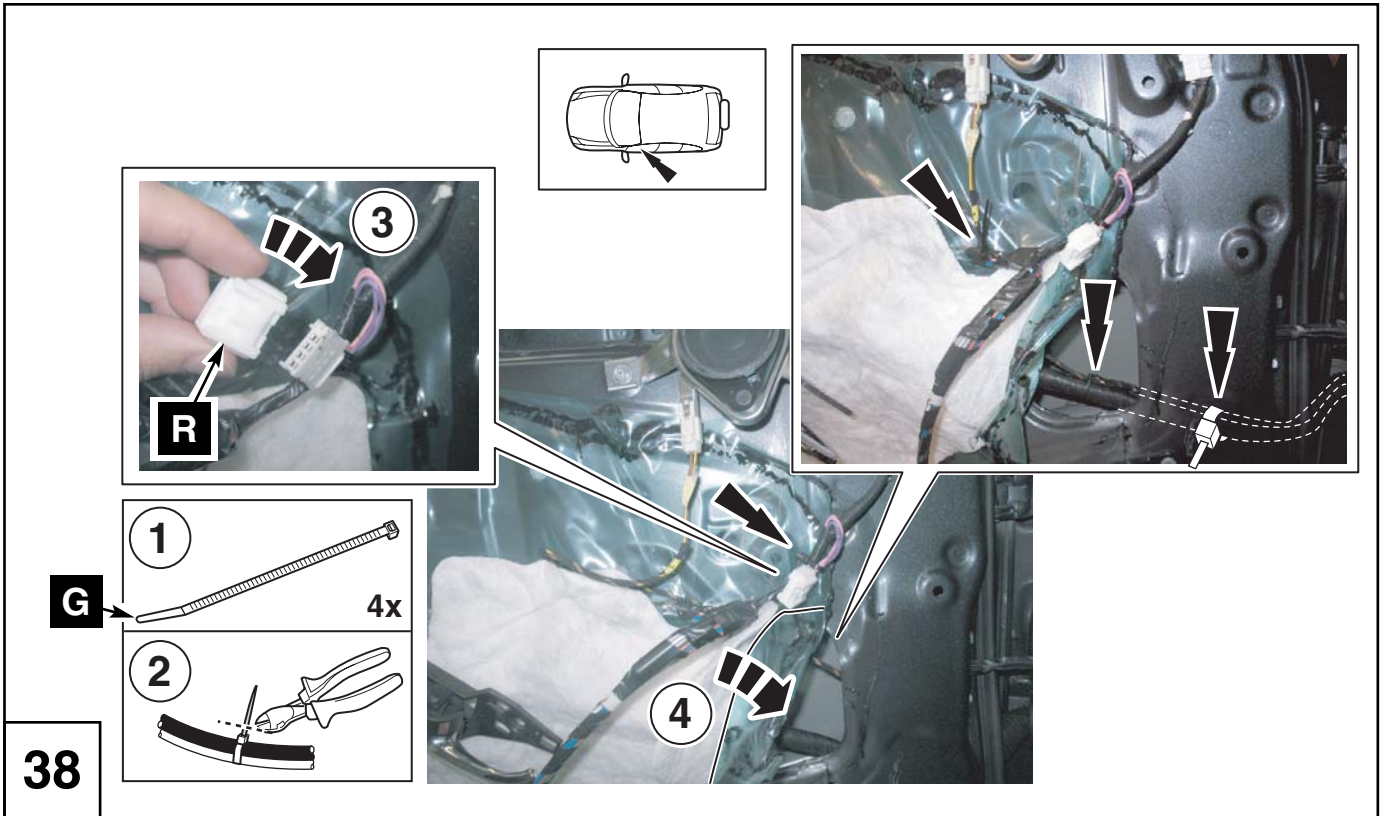

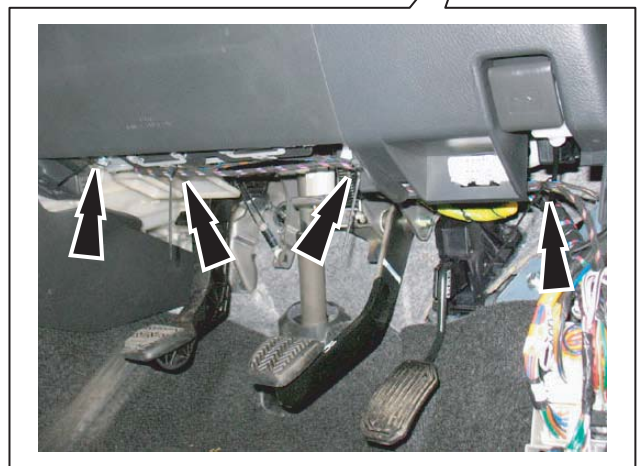
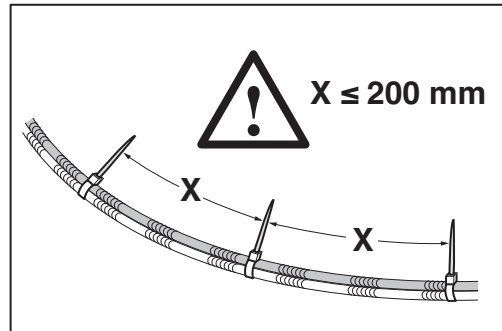

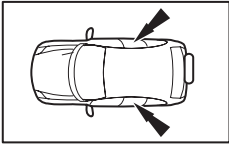

43

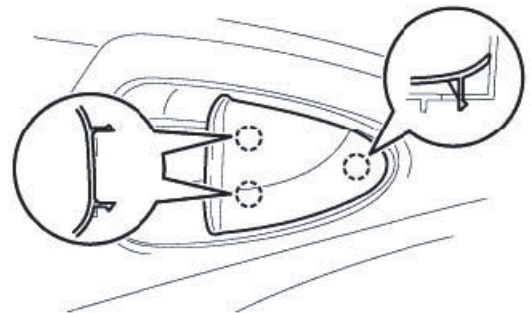
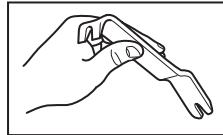
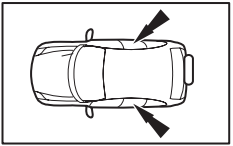

44

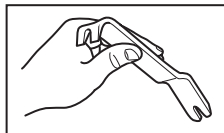
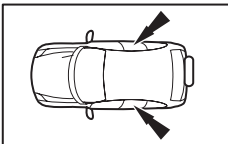

for 8 Clip Type:

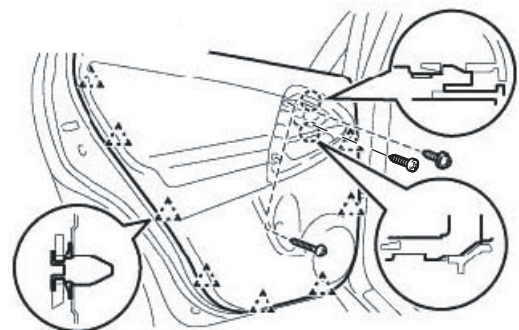
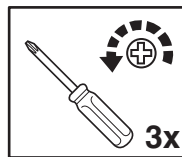

for 7 Clip Type:

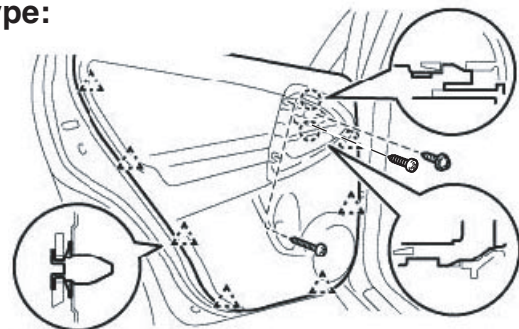
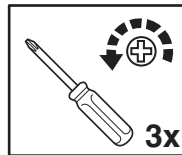

45

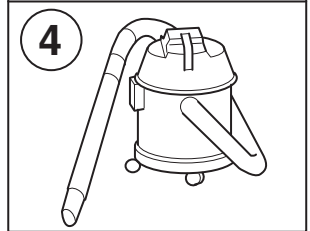
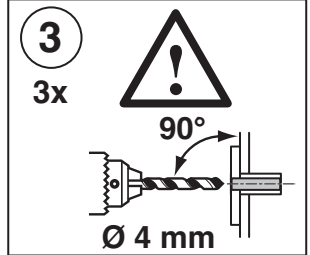
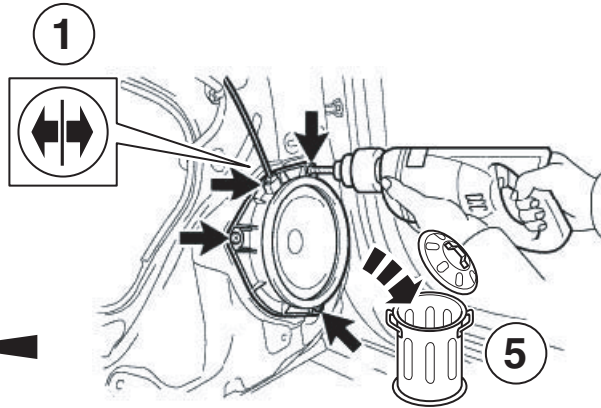
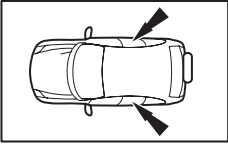

46

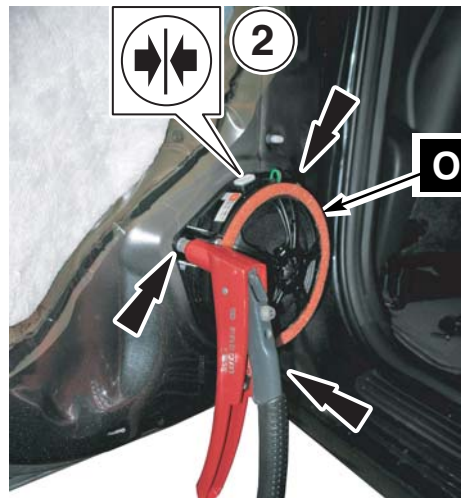
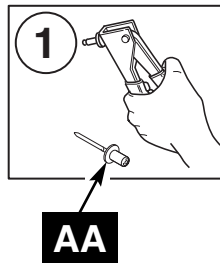
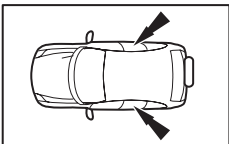

47

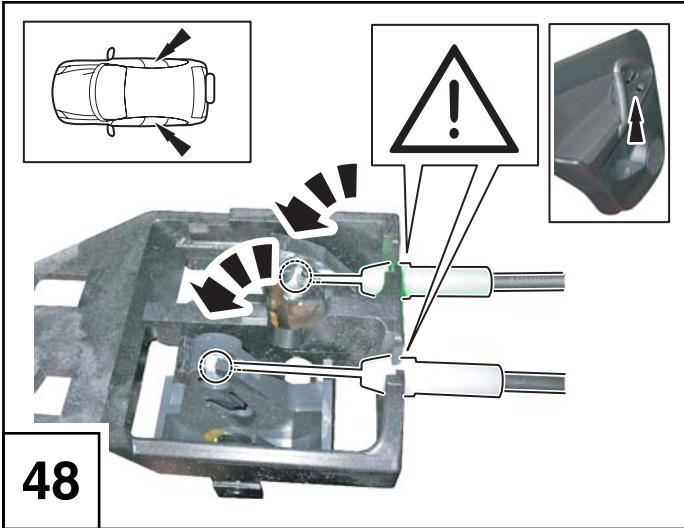



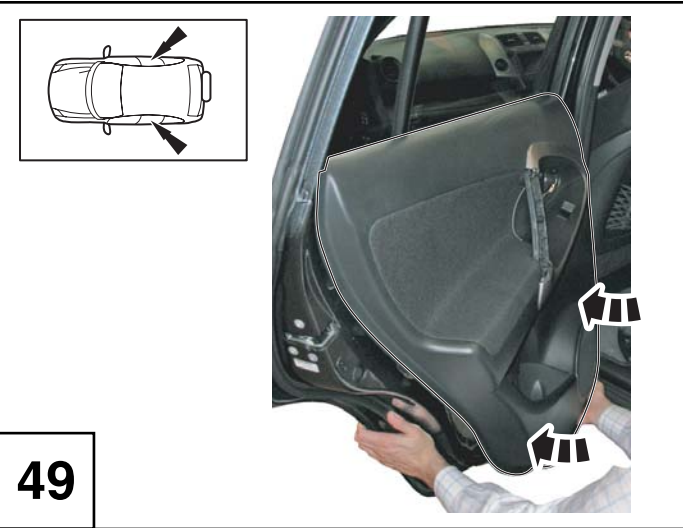







48



49



-  = 
-  = 
-  = 
-  = 
-  = 

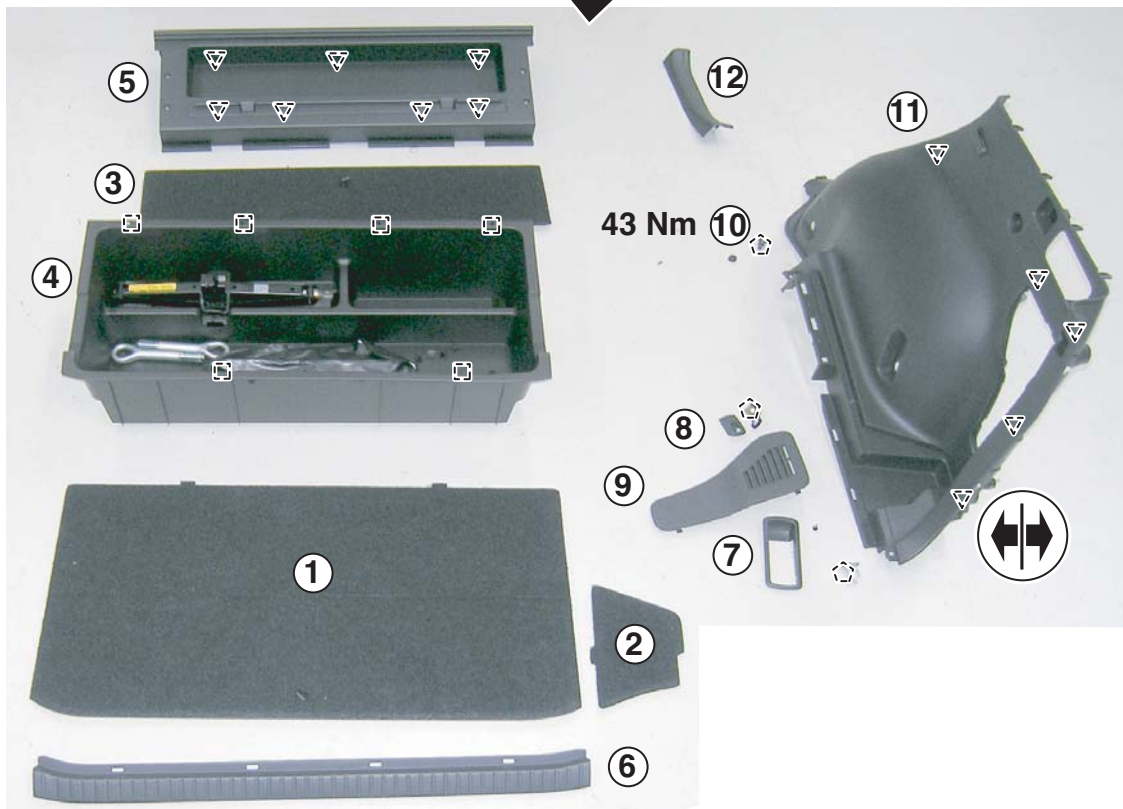
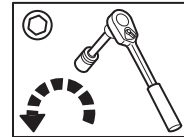
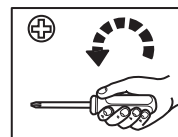
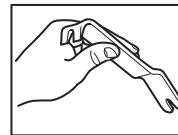

50

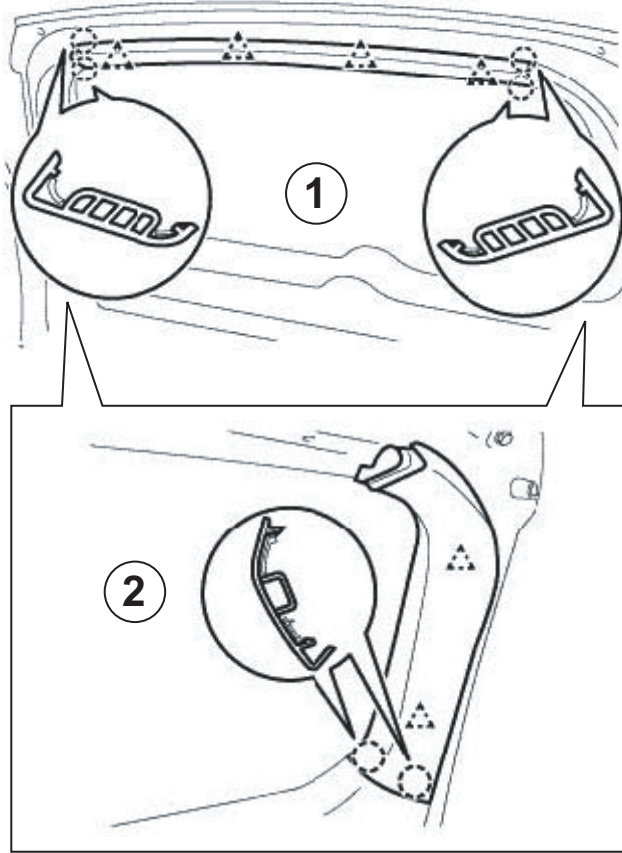
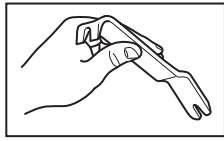

51

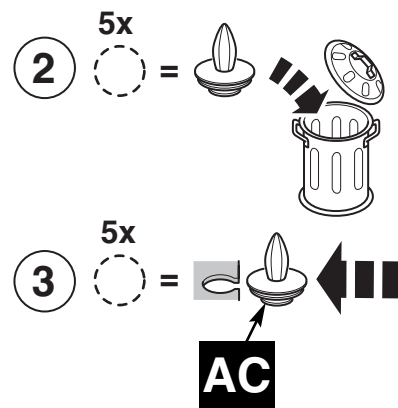
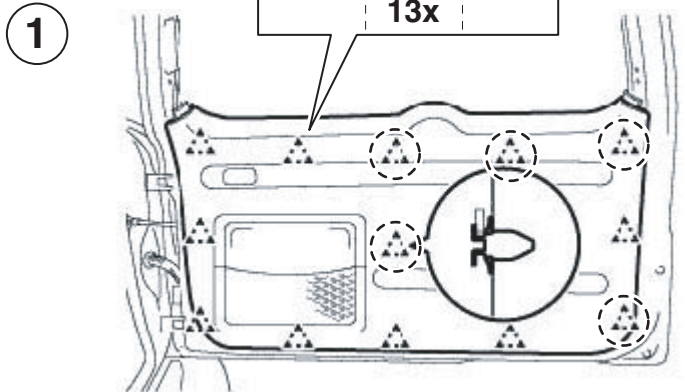
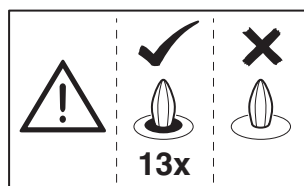
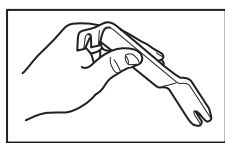

52

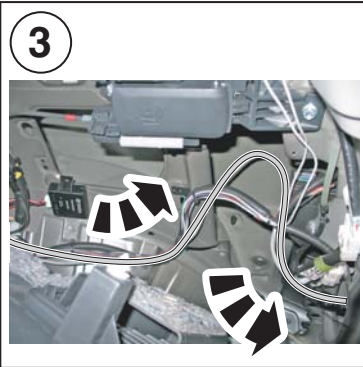
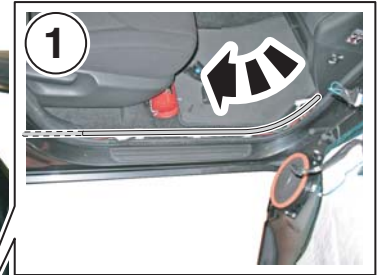
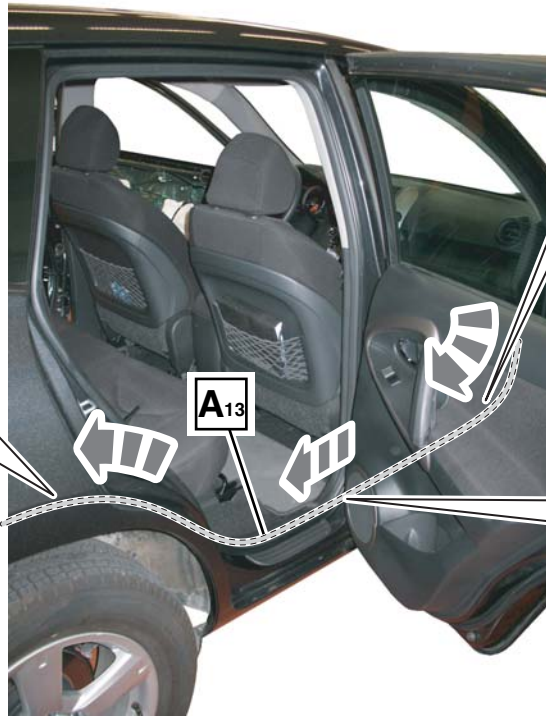
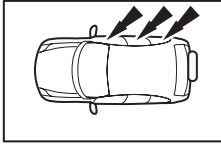

53

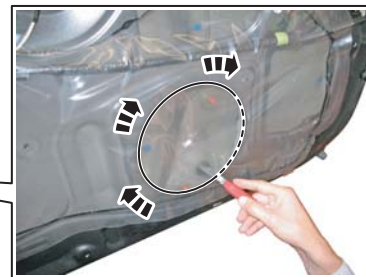
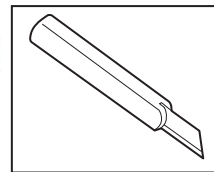

54

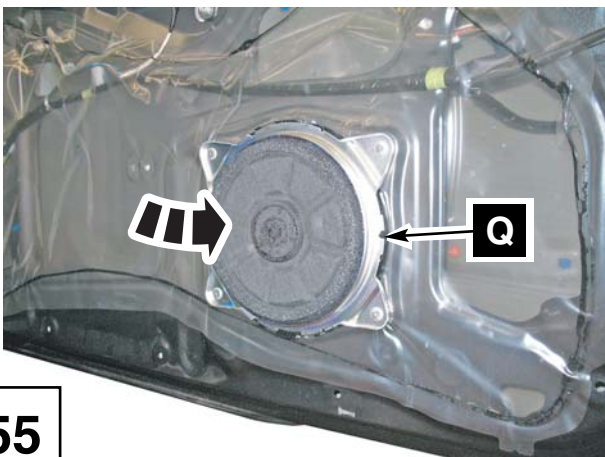

55

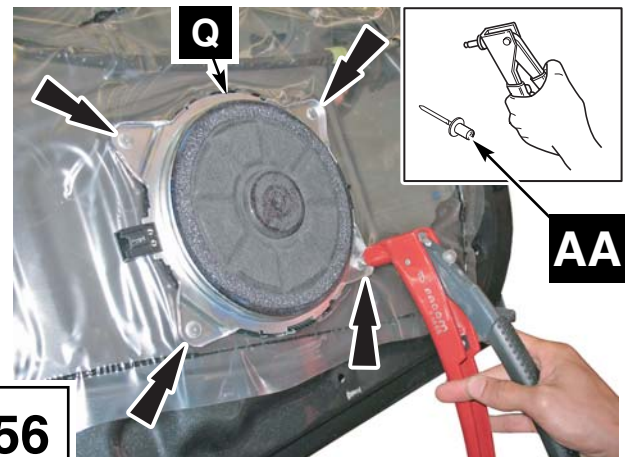

56

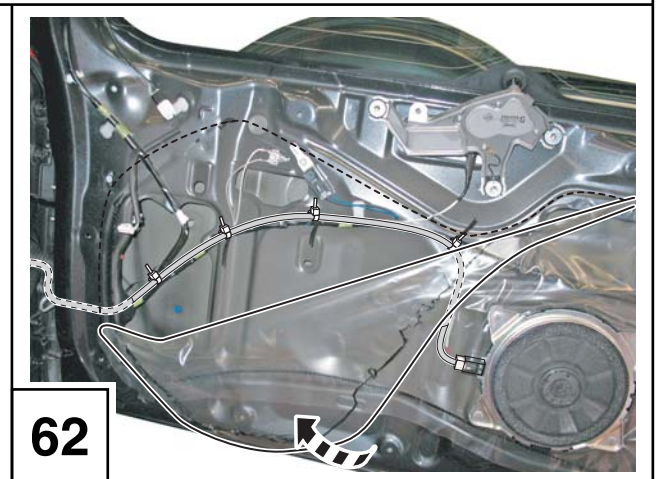
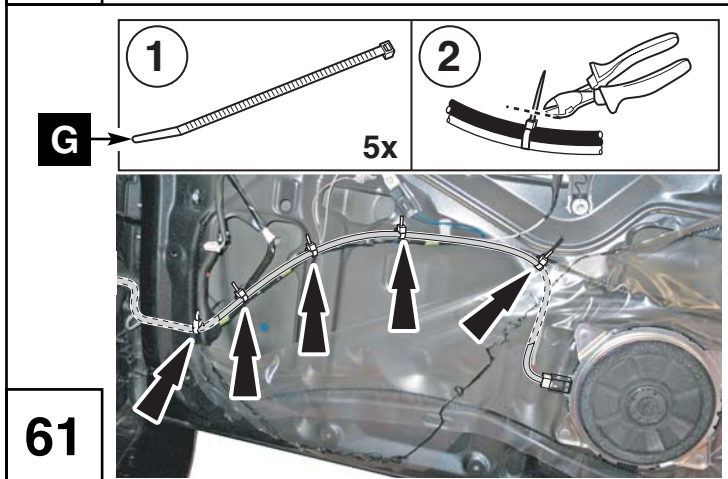
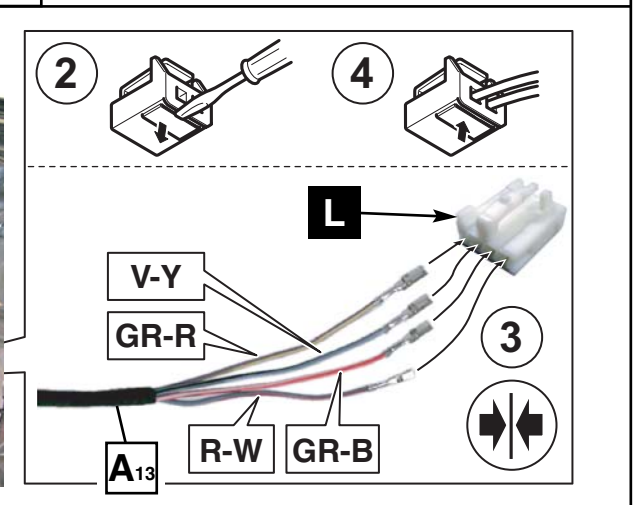
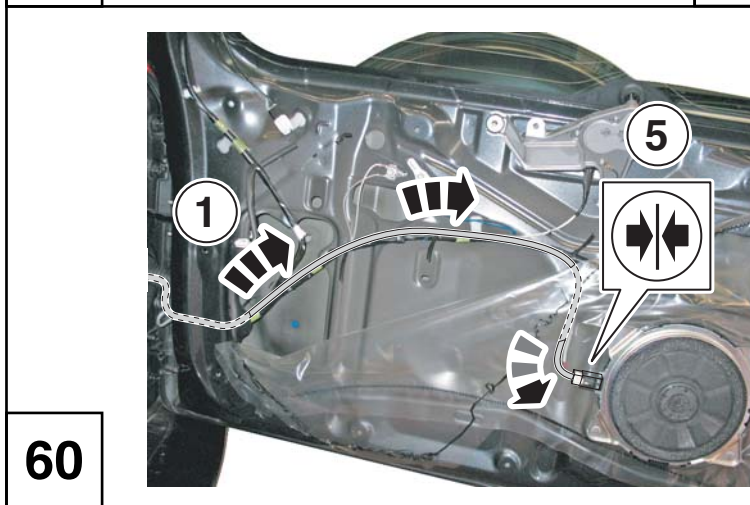
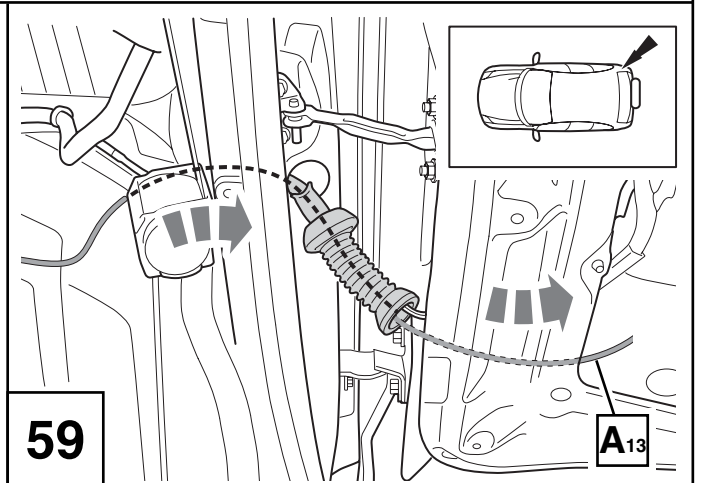
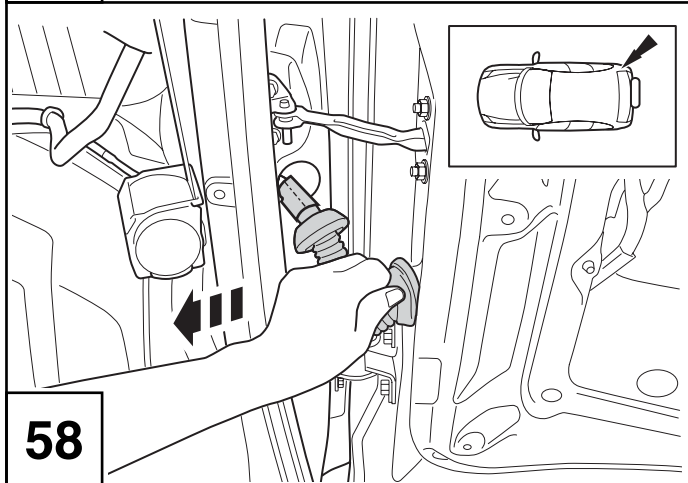
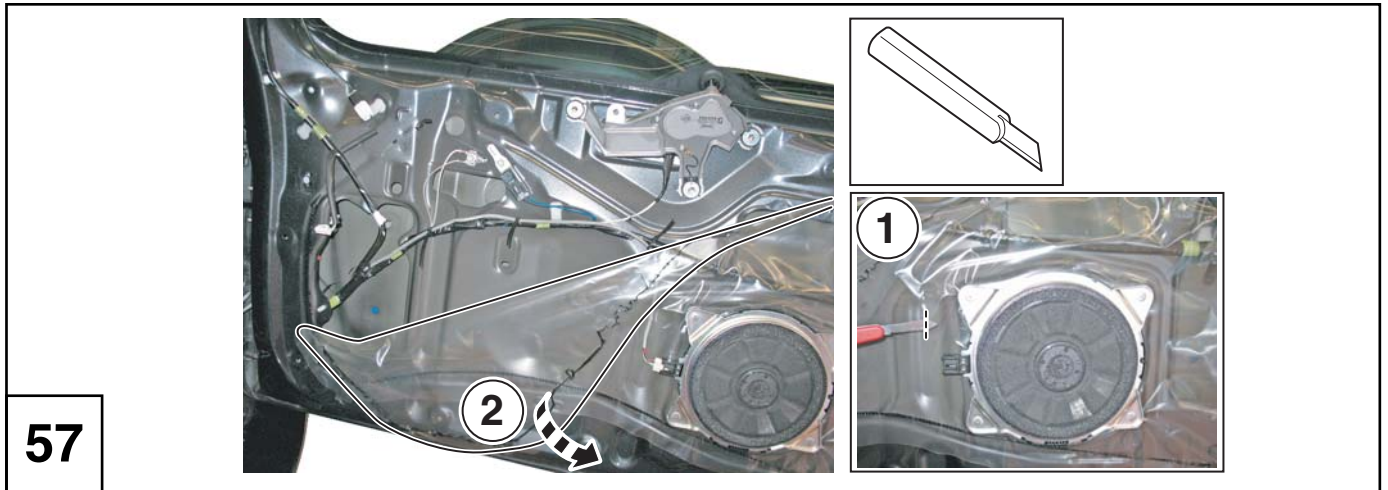

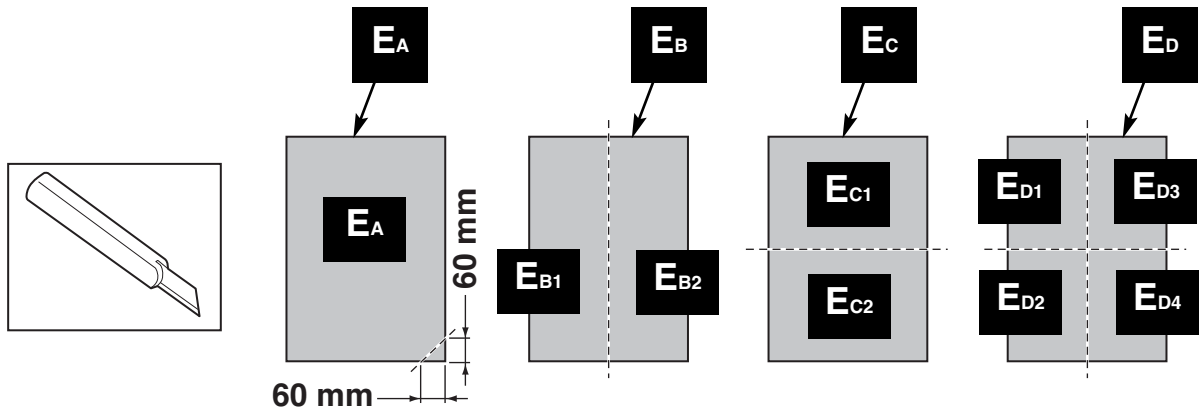

63

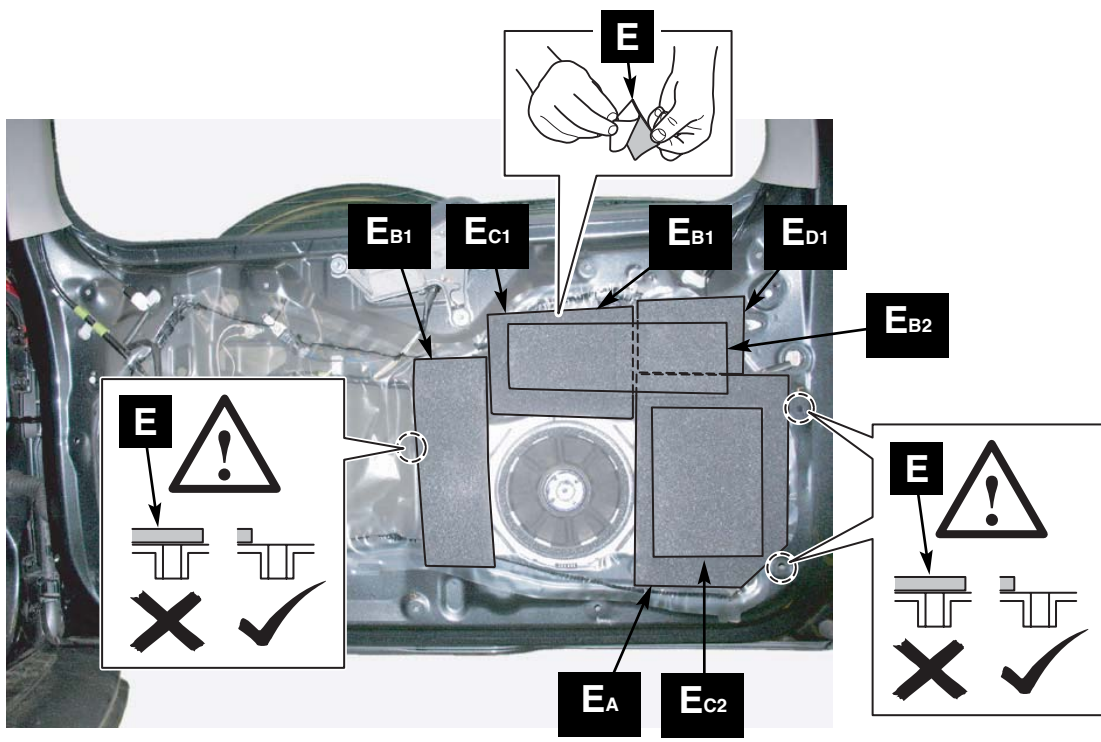

64



65



66

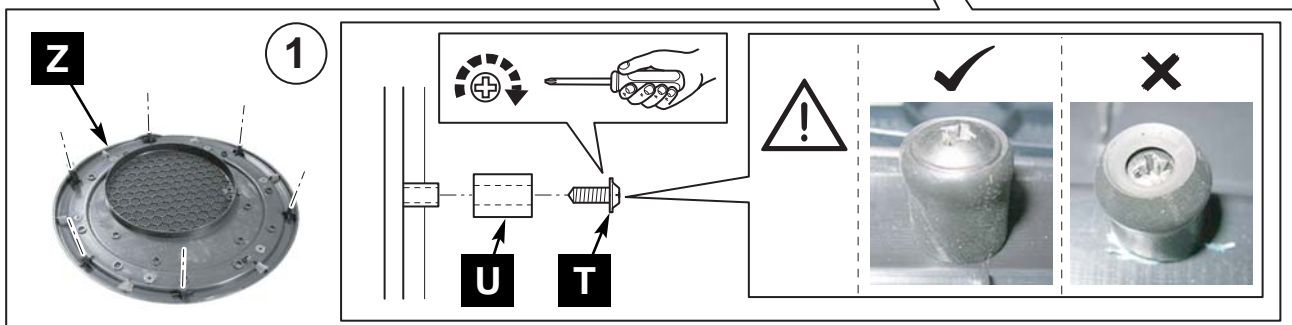

67

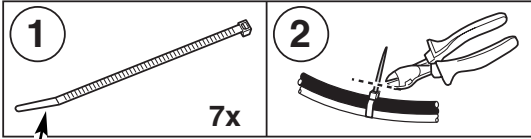

G

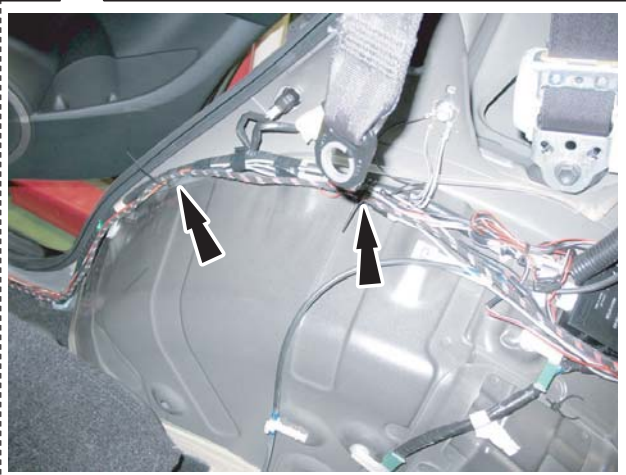
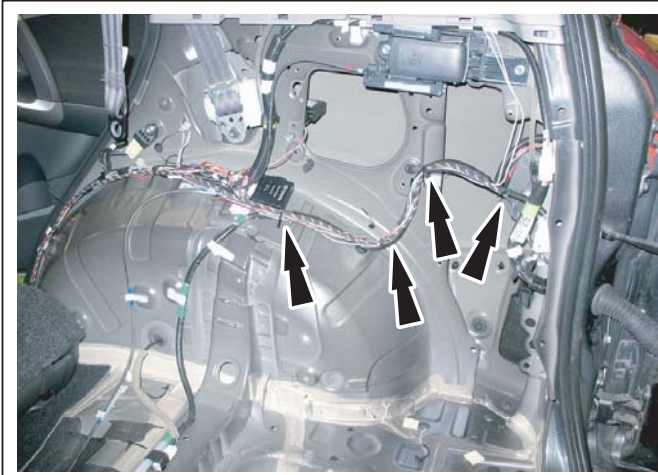
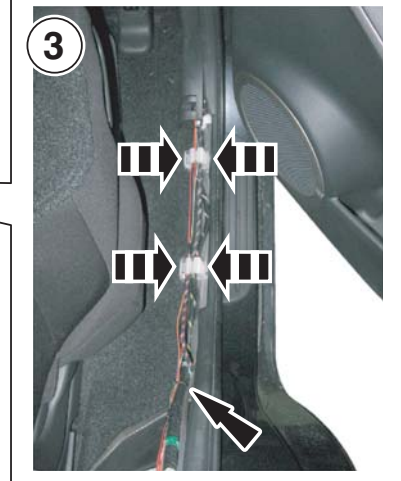
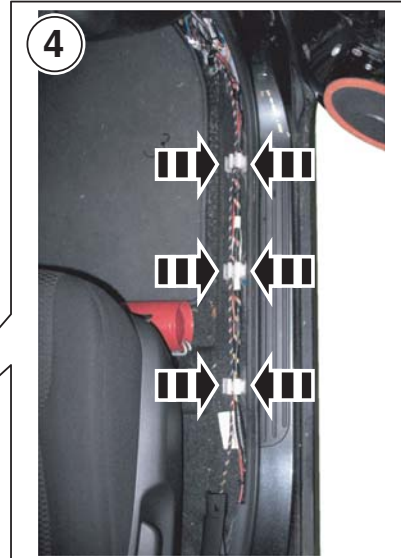
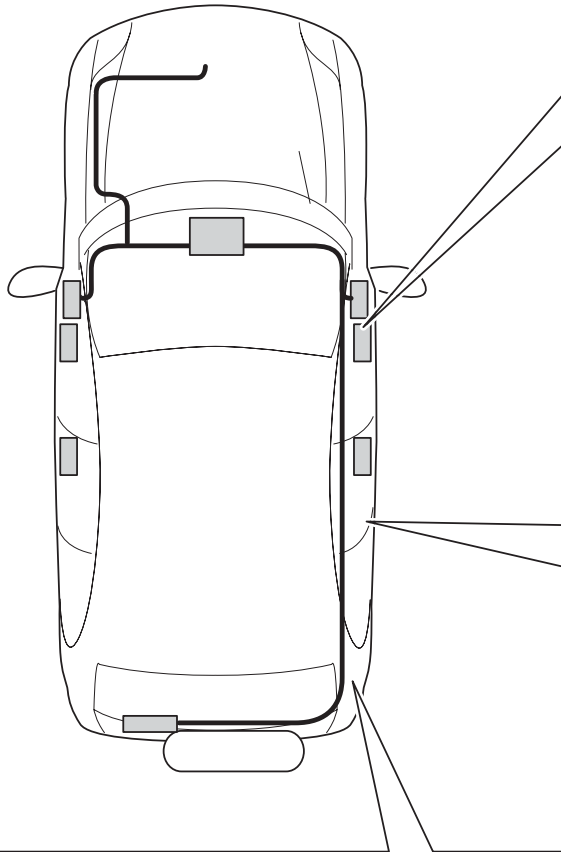

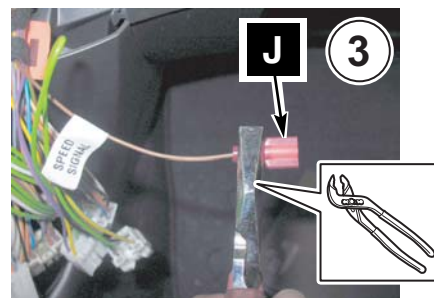
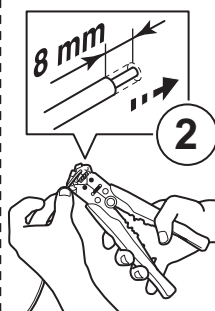
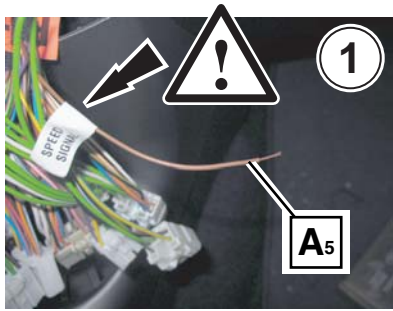

STANDARD NAVI

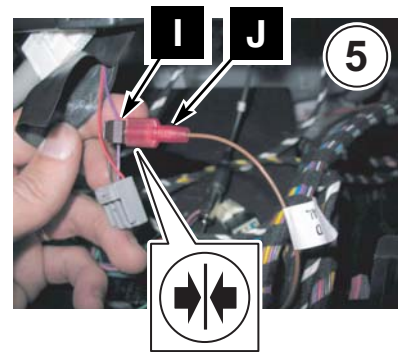
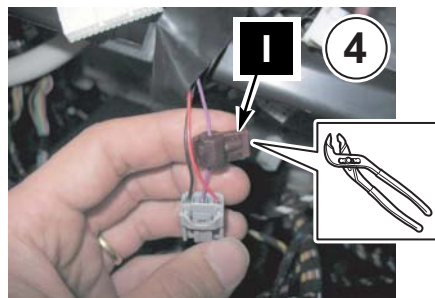
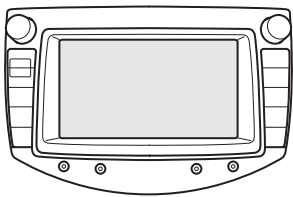

STANDARD RADIO

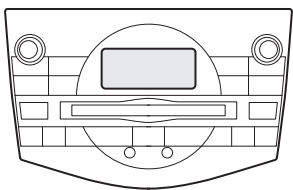

20P (WHITE)

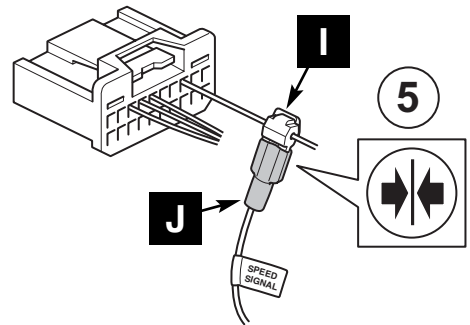
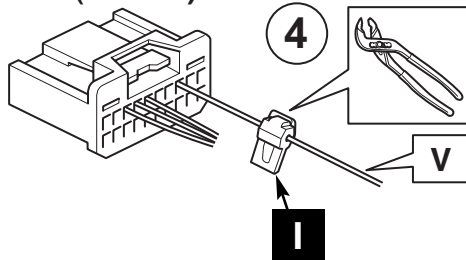

TNS600

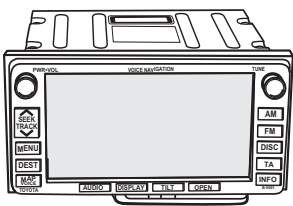

20P (WHITE)

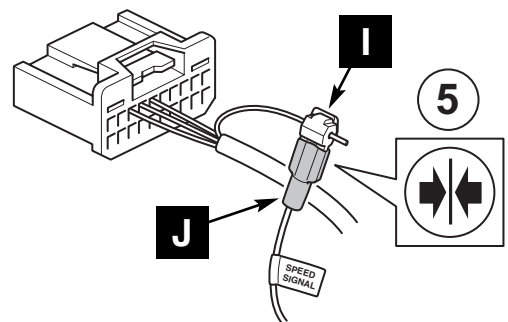
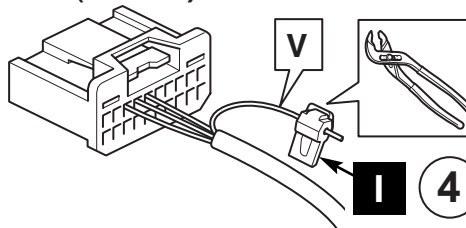

TNS700

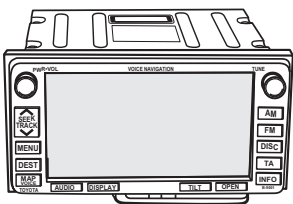

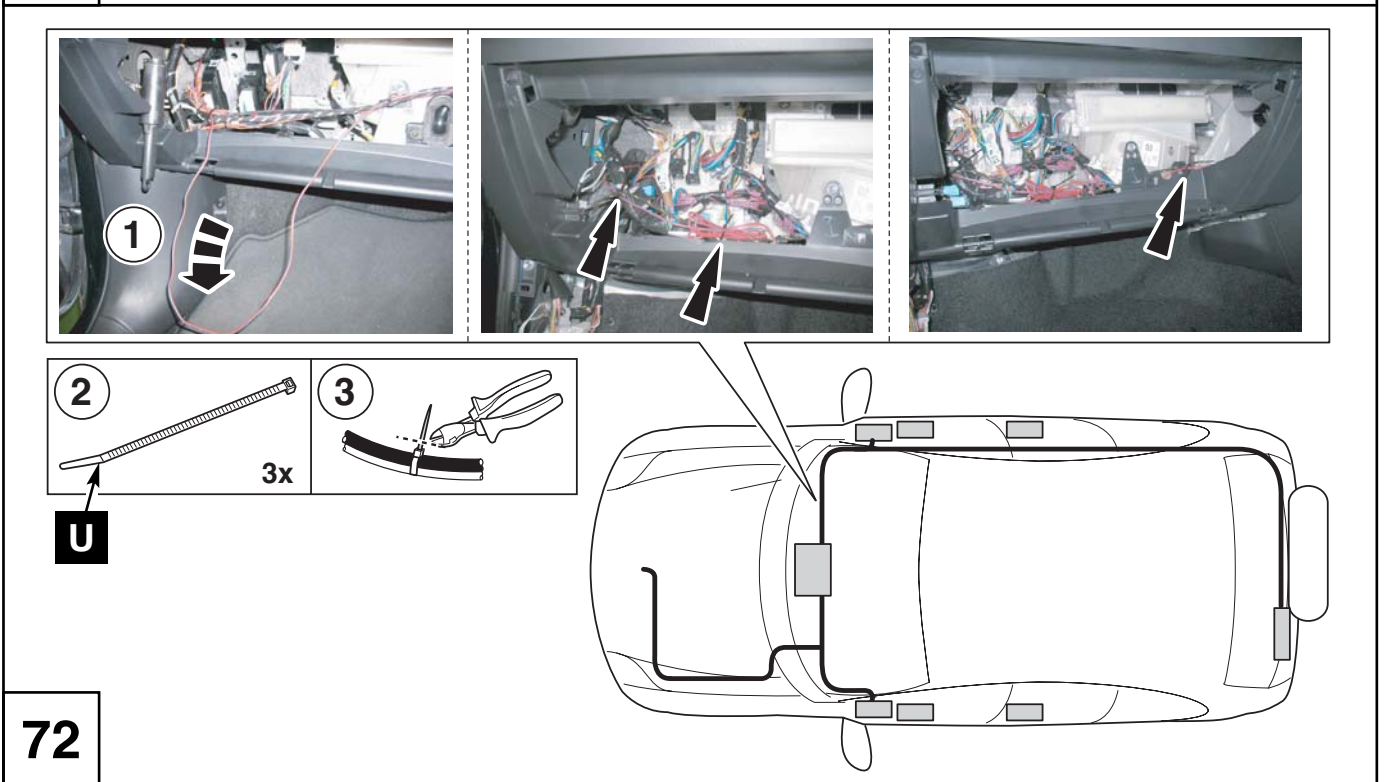
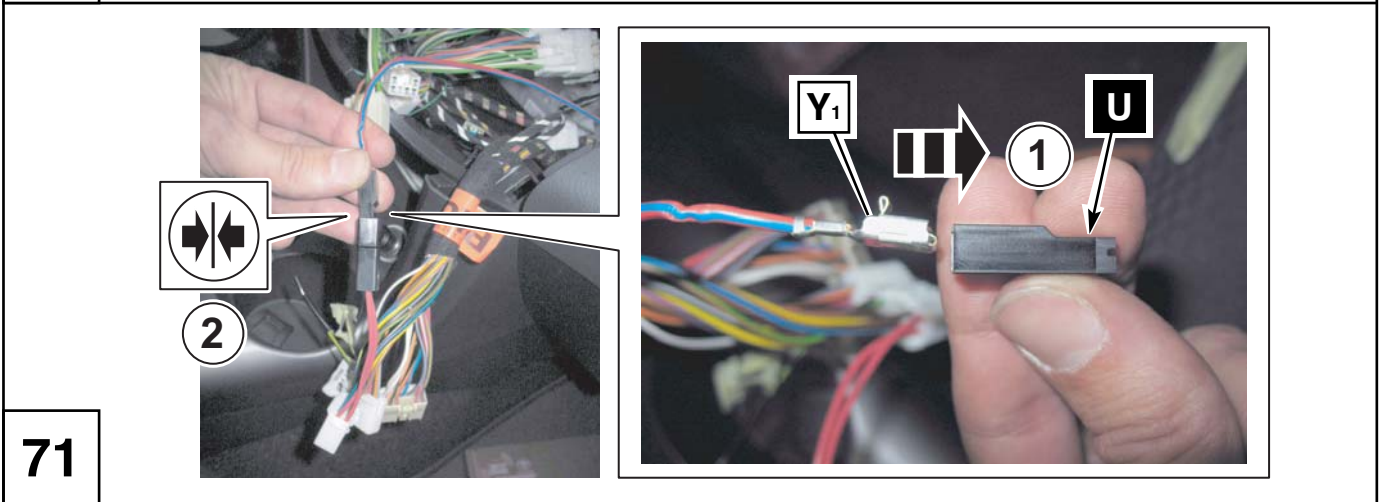
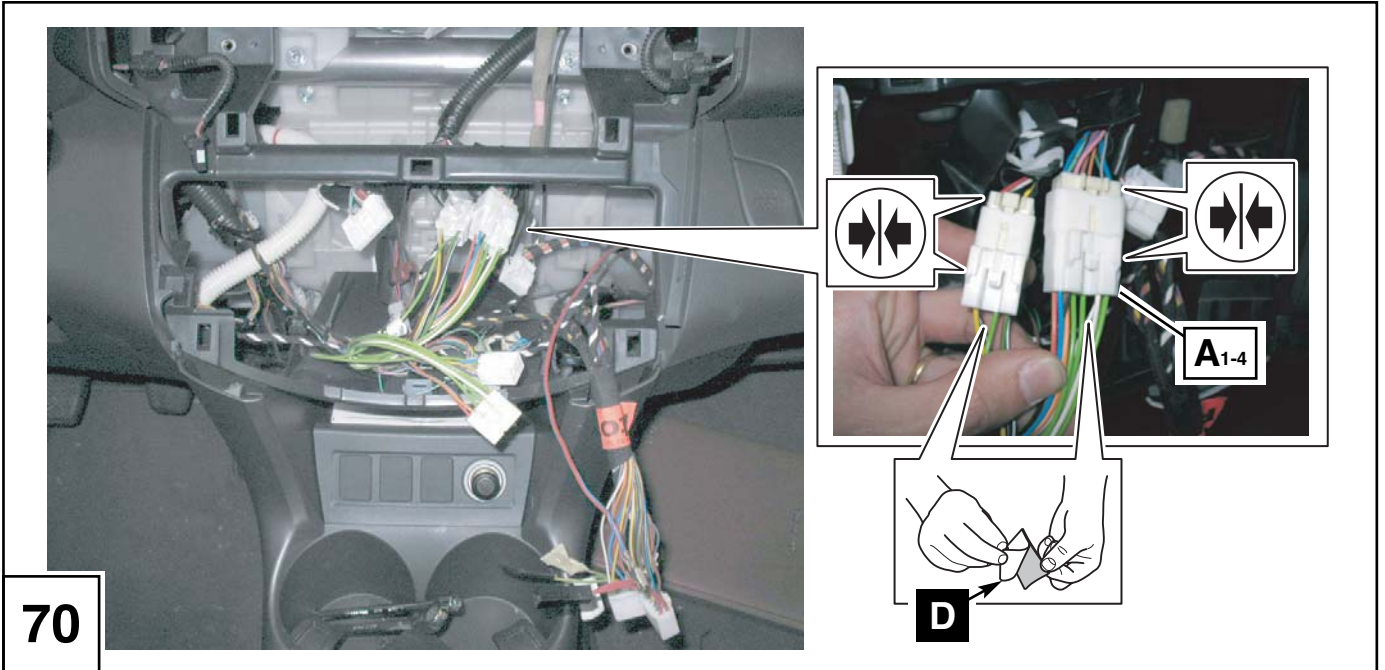

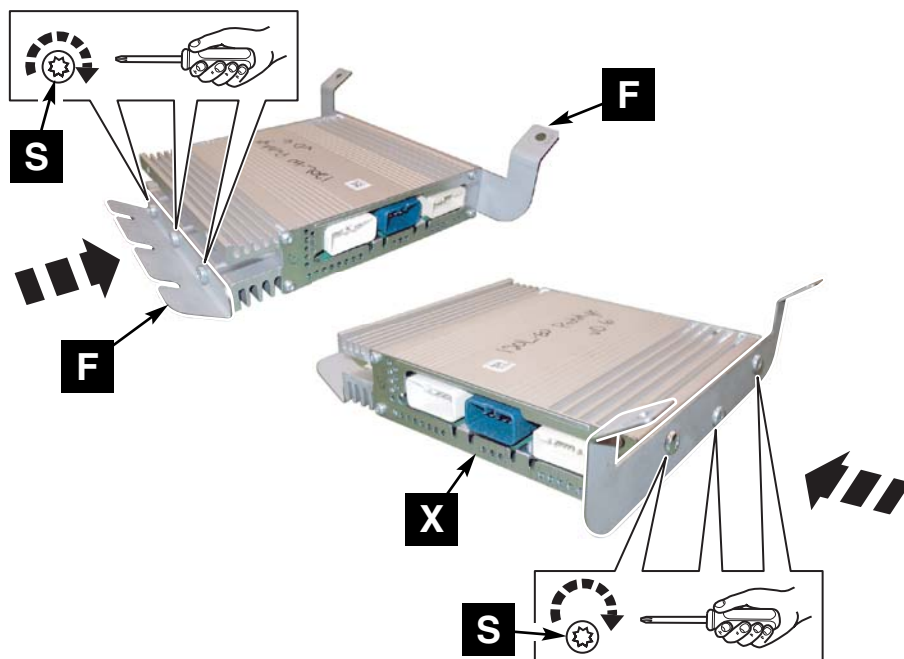

73

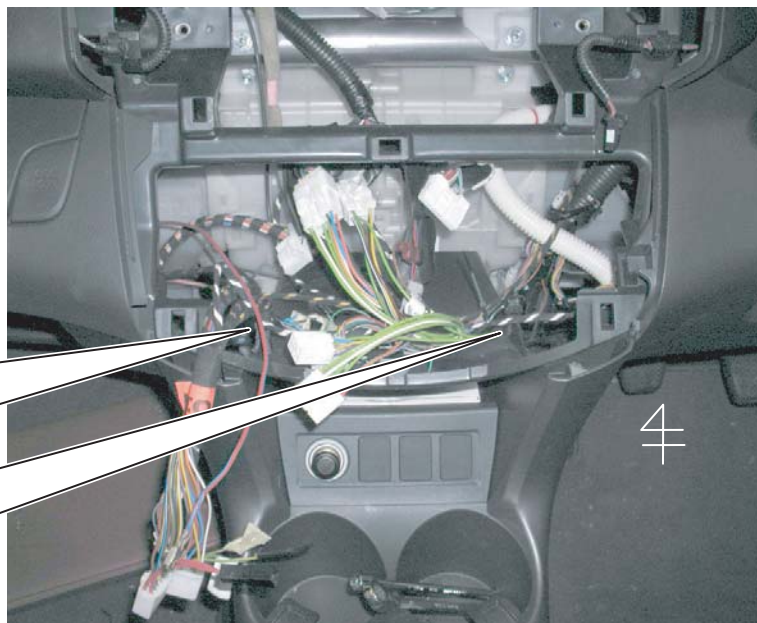
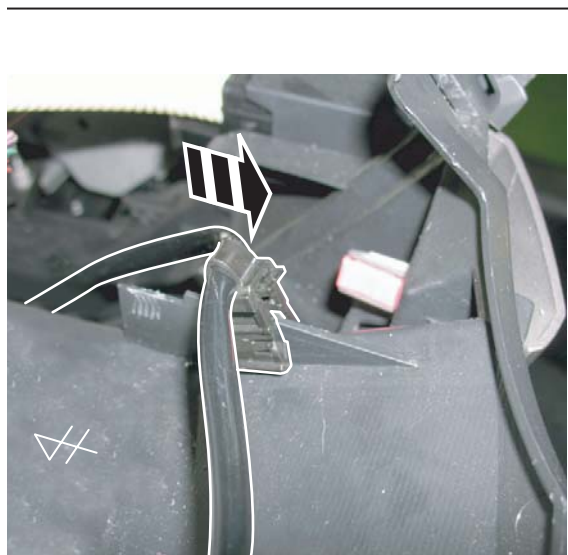

74



If Bluetooth hands free system:

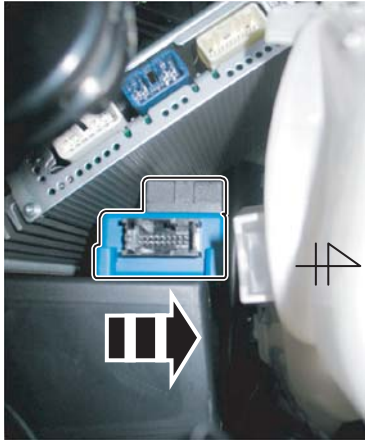

If SWC Bluetooth hands free system:

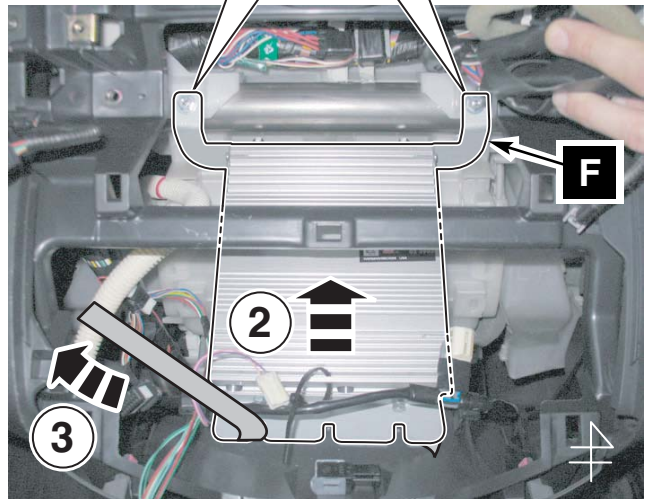
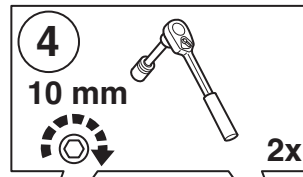
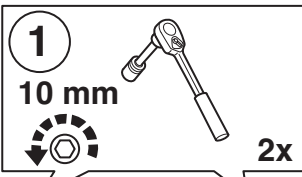
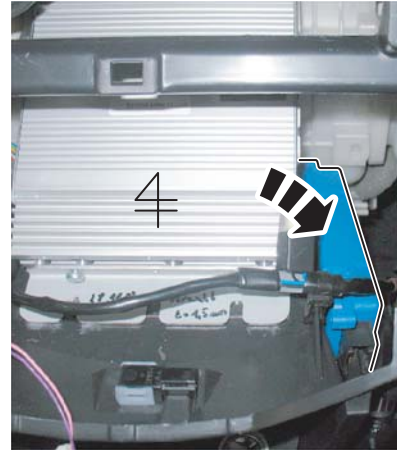

75

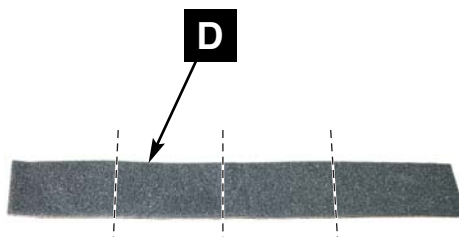
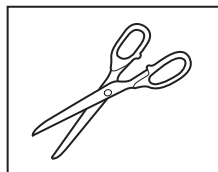

76

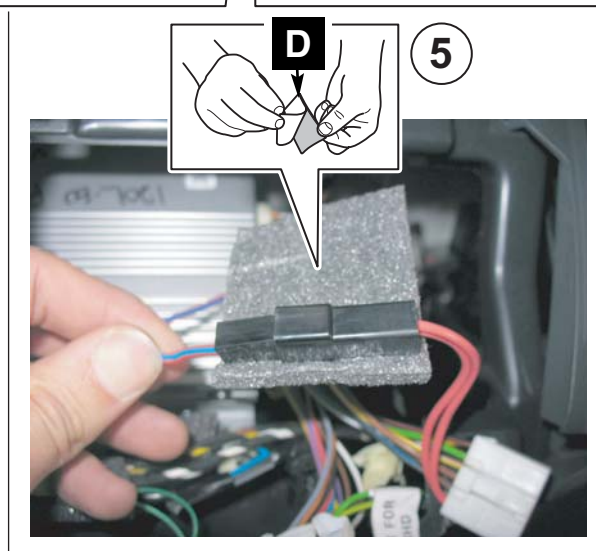
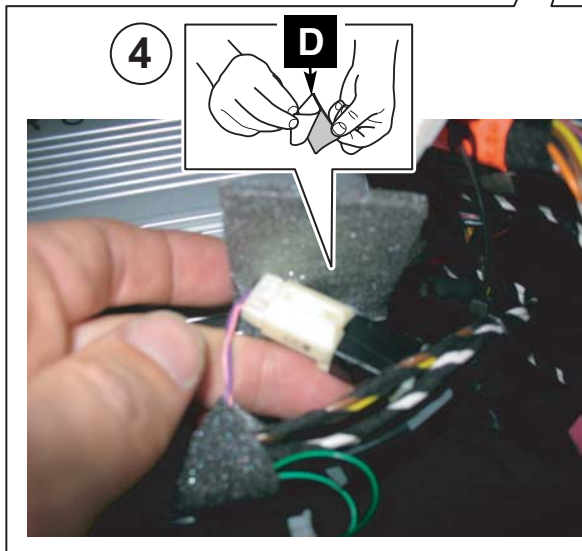
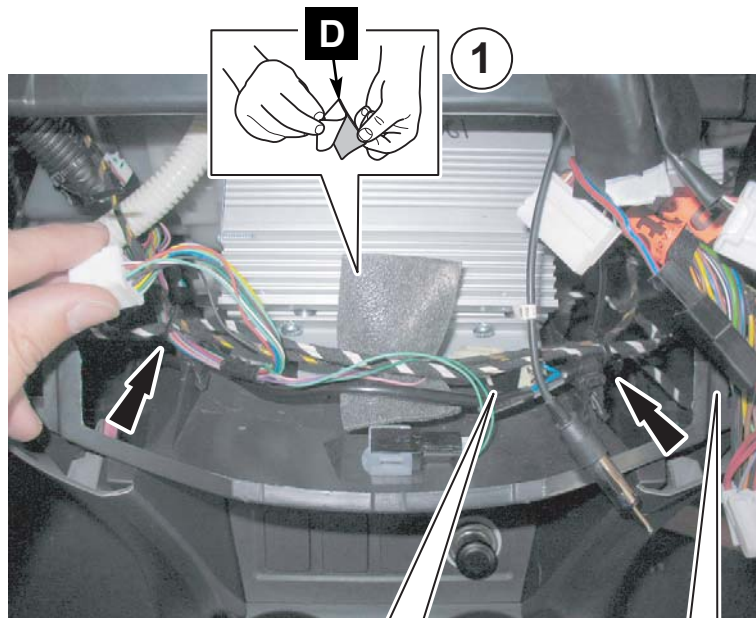

77

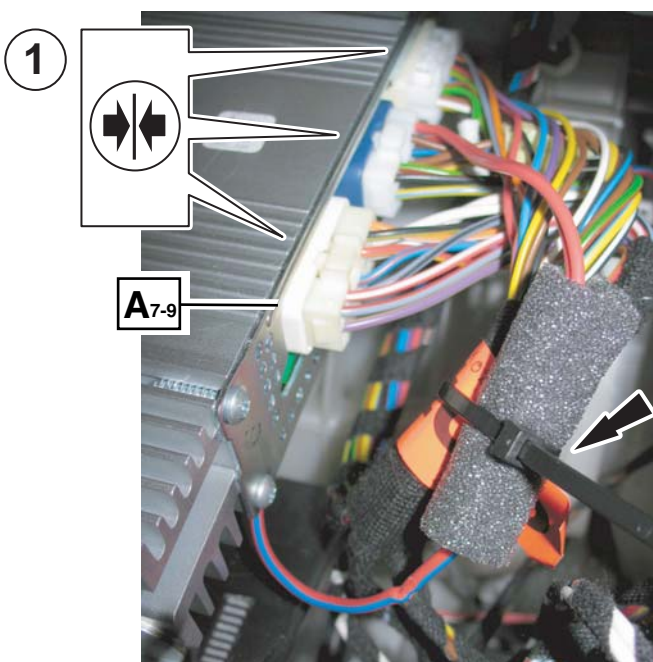

78

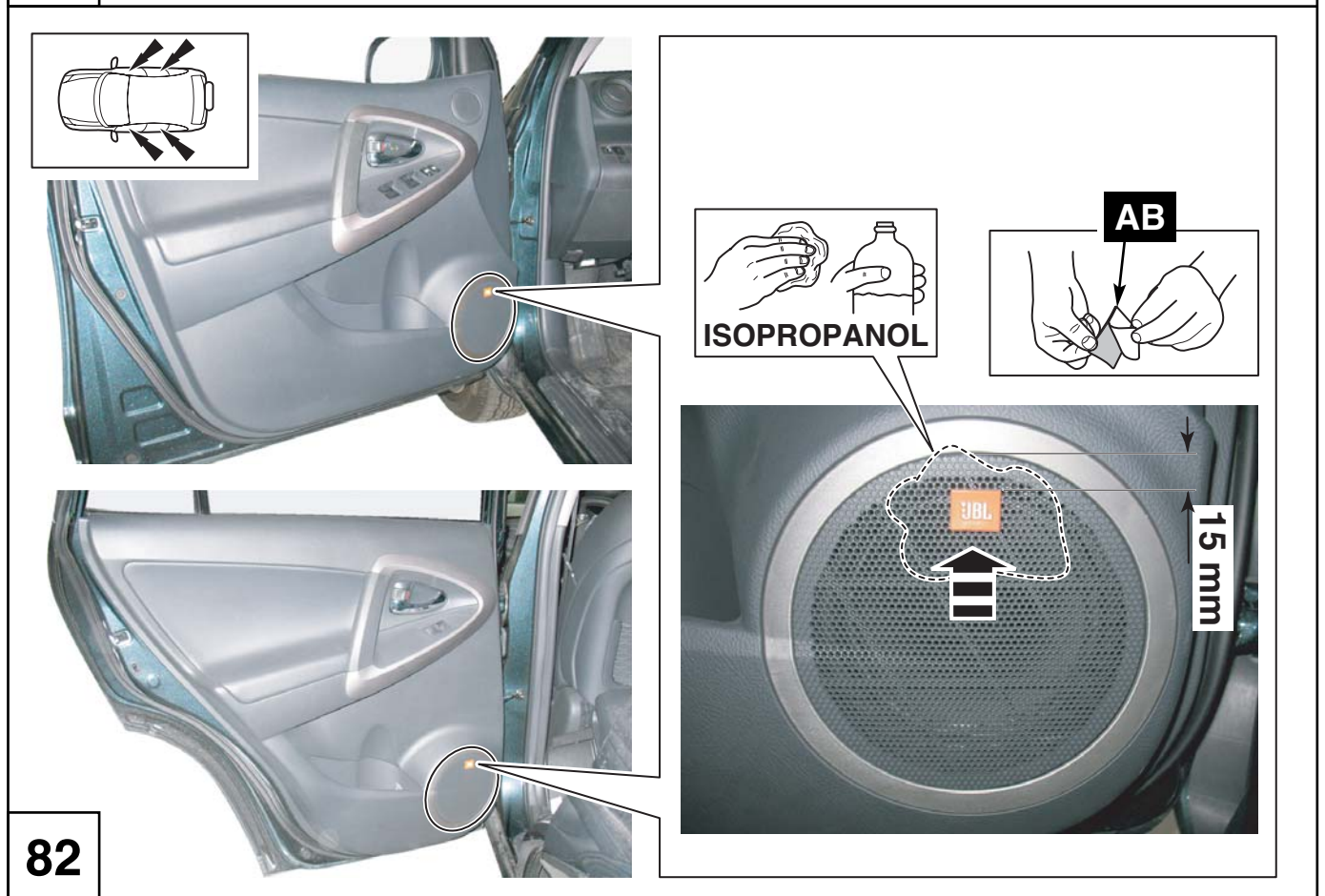
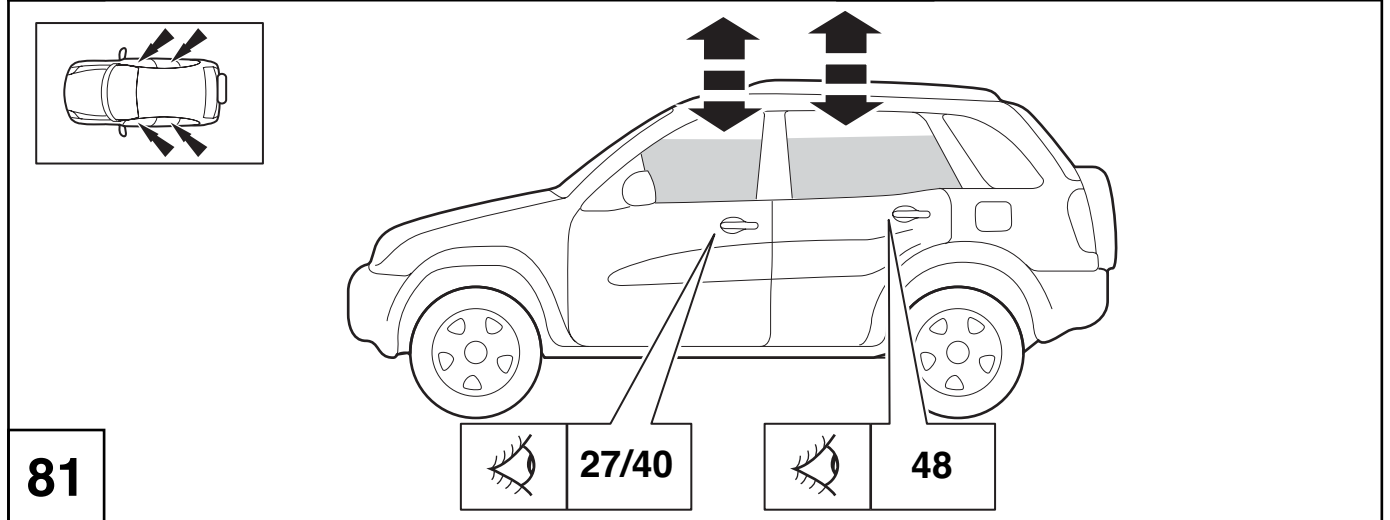
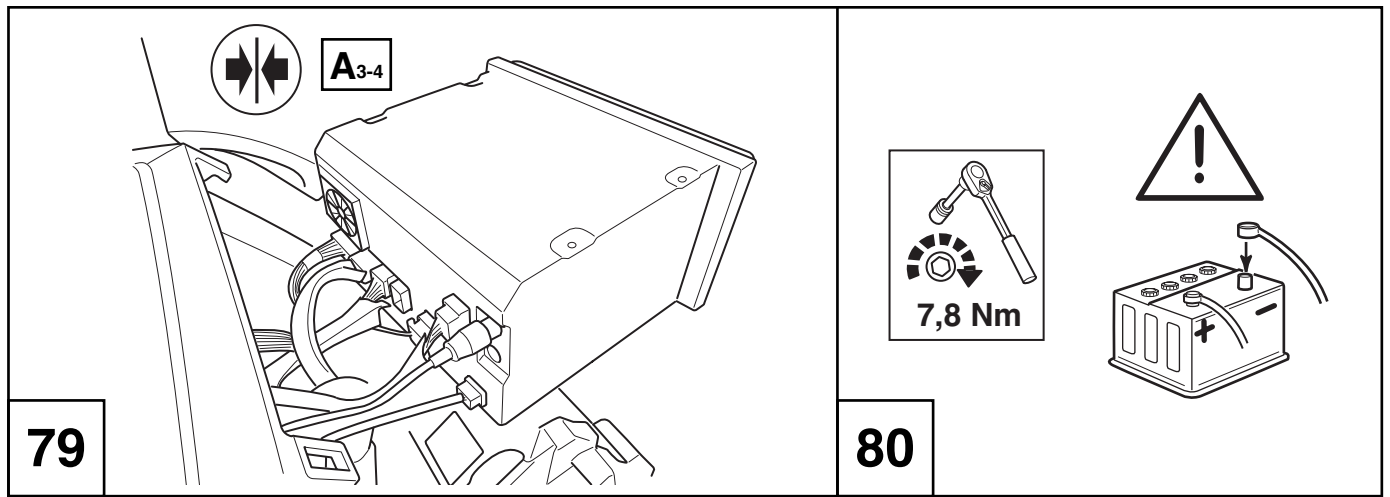

1

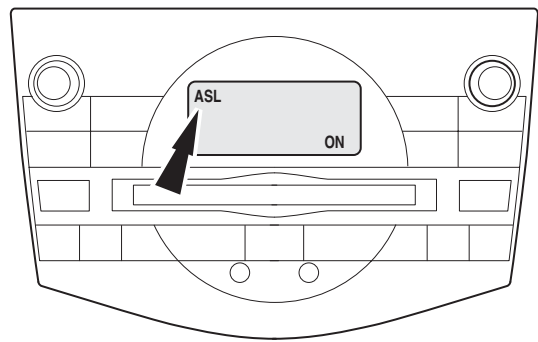
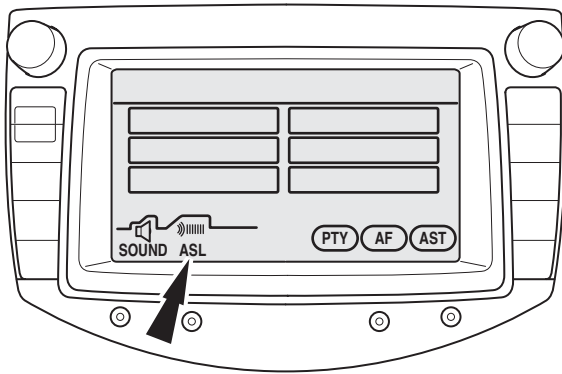

2

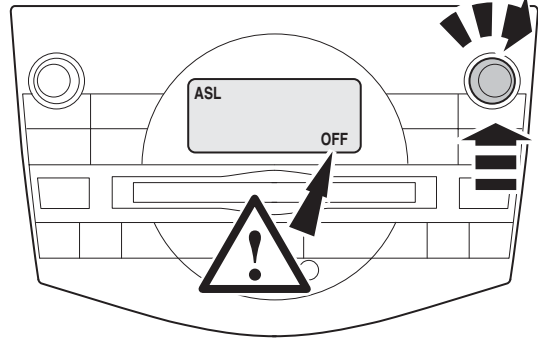
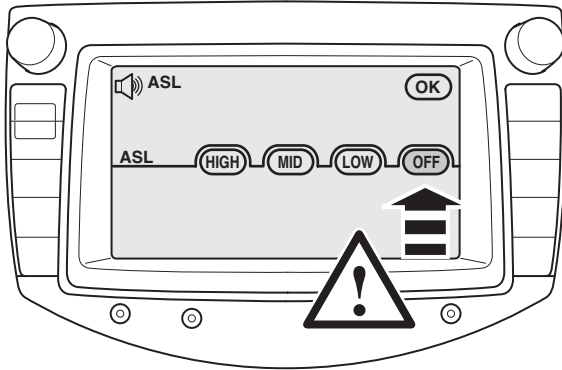

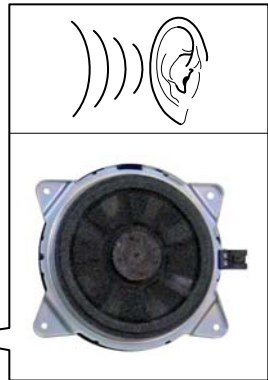
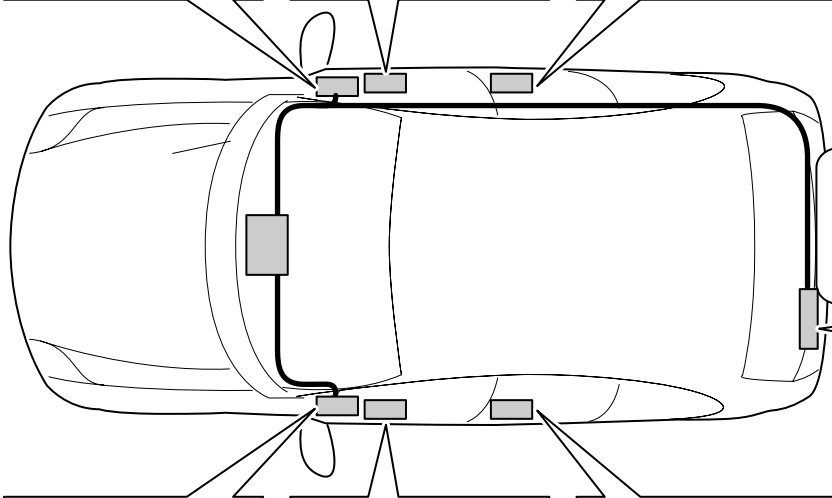
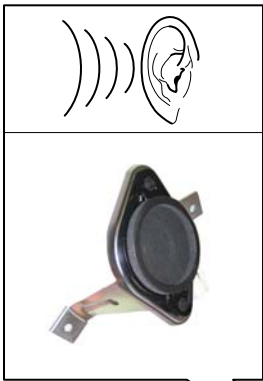
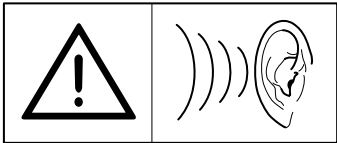

84

 45 of 46
46 of 46

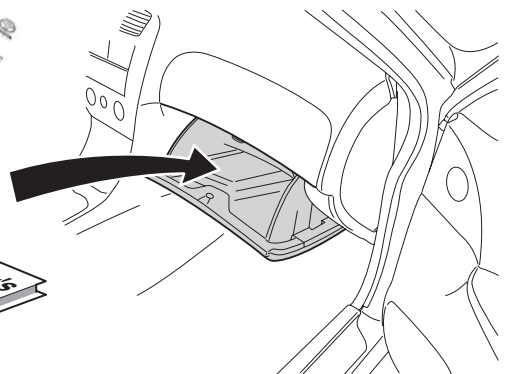
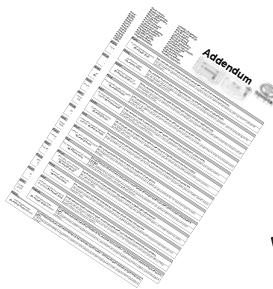

85

Owner's manual
Bedienungsanleitung
Manual del propietario
Mode d'emploi
Manuale d'uso
Korisnički priručnik
Příručka uživatele
Producentens vejledning
Gebruikershandleiding
Omaniku käsiraamat
Καyttäjän käsikirja
Εγχειρίδιο ιδιοκτήτη
Használati utasítás
Udhëzim për përdorim

Lietotāja rokasgrāmata
Naudojimosi instrukcija
Manwal tas-Sid
Brukerveiledning
Instrukcijska obruka
Manual do Proprietário
Manualul utilizatorului
Руководство пользователя
Korisnički priručnik
Příručka majiteľa
Uporabniški priročnik
Bruksanvisning
Kullanışın El Kitabı
Посібник користувача

Addendum

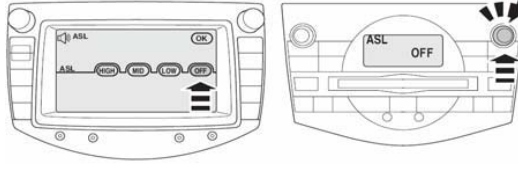

English	
For RAV4 equipped with genuine JBL Premium Sound	ASL (Automatic Sound Levelizer) should be switched OFF to insure correct listening performance The JBL amplifier will adjust the sound level and spectrum precisely to assure your optimal listening experience while noise level is increasing with vehicle speed.
German	
Für RAV4 mit original JBL Premium Sound	ASL (Automatic Sound Levelizer) sollte abgeschaltet sein, um optimalen Hörerlebnis zu gewährleisten Der JBL Verstärker reguliert Lautstärke und Spektrum präzise, um Ihnen ein optimales Hörerlebnis zu garantieren, wenn der Geräuschpegel mit der Fahrzeuggeschwindigkeit zunimmt.
Spanish	
Para RAV4 equipados con JBL Premium Sound genuino	El ASL (Automatic Sound Levelizer) debe desactivarse para asegurar una buena calidad de sonido El amplificador JBL ajustará con precisión el nivel de sonido y el espectro para asegurar la calidad del sonido óptima al aumentar el sonido en función de la velocidad del vehículo.
French	
Pour les RAV4 équipés d'un système JBL Premium Sound	L'ASL (Automatic Sound Levelizer) doit être réglé sur OFF pour garantir une écoute correcte L'amplificateur JBL règle de manière précise le niveau de son et le spectre pour garantir une écoute optimale lorsque le niveau de bruit augmente avec la vitesse du véhicule.
Italian	
Per RAV4 dotato di impianto audio originale JBL Premium Sound	L'ASL (Automatic Sound Levelizer) dev'essere OFF (spento) per garantire delle prestazioni di ascolto corrette L'amplificatore JBL regolerà il livello sonoro e lo spettro in modo da garantire la vostra esperienza di ascolto ottimale anche quando il livello di rumorosità aumenta con la velocità del veicolo.
Croatian	
Za RAV4 opremljen izvornim JBL Premium Sound	ASL (Automatic Sound Levelizer) treba postaviti na OFF kako bi se osigurala pravilna performansa slušanja JBL pojačalo će precizno prilagoditi razinu i spektar zvuka kako bi se osigurao optimalni doživljaj slušanja kada se razina buke povećava s povećanjem brzine vozila.
Czech	
Vozidla RAV4 vybavena originálním systémem JBL Premium Sound	Pro zajištění správných parametrů poslechu je nutné ASL (Automatic Sound Levelizer) přepnout do polohy OFF. Zesilovač systému JBL upraví hlasitost a spektrum tak, aby se hlasitost zvyšovala s narůstající rychlostí vozidla a přitom byl zajištěn optimální poslech.
Danish	
til RAV4, der er udstyret med original JBL Premium Sound.	ASL-systemet (Automatic Sound Levelizer) skal slukkes for at sikre god lyd. JBL-forstærkeren justerer lydniveauet og lydspektret præcist for at sikre, at lytteren får optimal lytteoplevelse, når støjniveauet øges med bilens hastighed.
Dutch	
Voor RAV4 uitgerust met een origineel JBL Premium Sound	De ASL (Automatic Sound Levelizer) (automatische volumeregeling) dient uitgeschakeld te zijn (OFF) om de voorziene audiokwaliteit te verkrijgen The JBL-versterker zal het volume en het spectrum automatisch en nauwkeurig aanpassen om een optimale luisterervaring tot stand te brengen naarmate de snelheid van de auto en het omgevingslawaai toenemen.
Estonian	
RAV4 jaoks, mis on varustatud originaalse helisüsteemiga JBL Premium Sound	ASL (Automatic Sound Levelizer) peab olema välja lülitatud (OFF), et tagada õige kuulamistulemus. JBL võimendi reguleerib helitugevuse taset ja spektrit täpselt, et kindlustada teile optimaalne kuulamiskogemus, kui müratase tõuseb koos sõiduki kiiruse suurenemisega
Finnish	
RAV4 mallit, joissa on aito JBL Premium Sound.	Aito kuuntelunautinto saavutetaan kytkemällä ASL (Automatic Sound Levelizer) asentoon OFF JBL-vahvistin varmistaa parhaan mahdollisen kuuntelukokemuksen säätämällä äänen tasoa ja taajuusalueetta taustamelun lisääntyessä ajoneuvon nopeuden myötä.
Greek	
Για RAV4 εξοπλισμένο με αυθεντικό ηχοσύστημα JBL Premium Sound	Ο ASL (Automatic Sound Levelizer) θα πρέπει να απενεργοποιηθεί (OFF) για να εξασφαλιστεί σωστή ακουστική απόδοση. Ο ενισχυτής JBL θα ρυθμίσει τη στάθμη και το φάσμα του ήχου με ακρίβεια ώστε να σας προσφέρει βέλτιστη ακουστική εμπειρία καθώς η στάθμη θορύβου αυξάνει με την ταχύτητα του οχήματος.
Hungarian	
RAV4 számára eredeti JBL Premium Sound felszerelvé	A jó lehallgató teljesítmény biztosítása érdekében az ASL (Automatic Sound Levelizer – automata hangszint szabályozó) legyen kikapcsolva (OFF) A JBL erősítő pontosan beállítja a hangszintet és a spektrumot, ezzel biztosítva az optimális hangzásélményt, amikor a zajszint, a jármű sebességével, növekszik.

Kosovar	
RAV 4 është i pajisur me JBL Premium Sound original.	ASL (Automatic Sound Levelizer) duhet të jetë OFF për të pasur dëgjim me cilësi të mirë. Përforsuesi JBL do ta përshtatë nivelin dhe spektrin e zërit në mënyrë precize për të siguruar cilësi sa më të mirë të dëgjimit, njëherazi niveli i zërit rritet me rritjen e shpejtësisë së veturës.
Latvian	
RAV4 modeļiem, kas aprīkoti ar sistēmu JBL Premium Sound	funkcija ASL (Automatic Sound Levelizer) ir jāizslēdz (OFF), lai audiosistēma darbotos pareizi. Līdz ar transportlīdzekļa ātrumu palielinoties trokšņu līmenim, JBL pastiprinātājs precīzi noregulēs skaņas līmeni un spektru, lai nodrošinātu optimālu klausīšanos.
Lithuanian	
RAV4 automobiliams, kurie komplektuojami su „ JBL Premium Sound ” garso įranga,	ASL“ (automatinio garsumo reguliavimo) sistema turi būti IŠJUNGTA norint užtikrinti teisingą įrangos veikimą JBL stiprintuvas sureguliuos garsumo lygį ir spektrą preciziškai tam, kad garantuotų optimalius klausymosi pojūčius tuo metu, kai didėja automobilio greitis.
Maltese	
Għal RAV4 mgħammar b'sistema ġenwina JBL Premium Sound	ASL (Automatic Sound Levelizer) għandu jintefa (OFF) biex tiżgura prestazzjoni korretta tas-smigh Il-JBL amplifier ser jaġġusta l-livell tal-hoss u l-ispektrum b'mod preċiż biex jiżgura li jkollok l-aħjar esperjenza ta' smigh waqt li l-livell tal-hoss ikun qed jiżdied mal-veloċità tal-vettura.
Norwegian	
For RAV4 utstyrt med ekte JBL Premium Sound.	ASL (Automatic Sound Levelizer – automatisk lydutfjerner) skal være satt til OFF (av) for å forsikre korrekt lytteopplevelse JBL-forsterkeren vil presist justere lydnivået og spekteret for å forsikre korrekt lytteopplevelse når støynivået øker i takt med kjøretøyets hastighet.
Polish	
Dla pojazdów RAV4 wyposażonych w oryginalny JBL Premium Sound	ASL (Automatic Sound Levelizer) powinien być ustawiony w położeniu OFF, aby zapewnić prawidłowy odsłuch W miarę wzrostu poziomu hałasu w wyniku zwiększania prędkości, wzmacniacz JBL będzie precyzyjnie dostosowywał poziom dźwięku i widmo akustyczne dla zapewnienia optymalnego odsłuchu.
Portuguese	
Para o RAV4 equipado com o JBL Premium Sound	Dever-se-á desligar (OFF) o ASL (Automatic Sound Levelizer) para garantir o desempenho de audição correcto. O amplificador JBL ajustará o nível do som e o espectro com precisão para garantir a sua audição ideal, à medida que o nível de ruído aumenta com a velocidade do veículo.
Romanian	
Pentru RAV4 echipat cu JBL Premium Sound original	ASL (Automatic Sound Levelizer) trebuie decuplat (OFF) pentru a asigura performanța corectă a audiției Amplificatorul JBL va regla precis volumul și spectrul sunetului pentru a vă asigura o experiență optimă a audiției în timp ce nivelul de zgomot crește odată cu viteza vehiculului.
Russian	
Для RAV4, оборудованного настоящей системой JBL Premium Sound	Переключатель ASL (Automatic Sound Levelizer) должен находиться в положении OFF (ВЫКЛ), чтобы гарантировать правильные характеристики прослушивания Усилитель JBL будет точно настраивать уровень и спектральный состав звука, чтобы обеспечить Вам оптимальное прослушивание, в то время как уровень шума будет повышаться вместе со скоростью автомобиля.
Serbian	
Za RAV4 opremljen sa originalnim JBL Premium Sound	ASL (Automatic Sound Levelizer) treba prebaciti na OFF da se osigura ispravna performansa slušanja JBL pojačalo će precizno podesiti nivo i spektar zvukada. Vama osigura optimalni doživljaj slušanja kada se nivo buke povećava sa brzinom vozila.
Slovak	
Pre model RAV4 vybavený originálnou JBL Premium Sound	Ak chcete mať správny zážitok z počúvania, VYPNITE systém ASL (Automatic Sound Levelizer) Zosilňovač JBL presne prispôbi hlasitosť a spektrum zvuku tak, aby ste mali optimálny zvukový zážitok. Hlasitosť zvuku sa zvyšuje s rýchlosťou vozidla.
Slovene	
Velja za vozila RAV4 z originalnim JBL Premium Sound	Za pravilno zvočno doživetje naj bo ASL (Automatic Sound Levelizer) izklopljen – položaj OFF. JBL ojačevalnik bo za optimalno poslušanje ob povečanem šumu zaradi večje hitrosti vozila natančno uravnaval glasnost in glasovni obseg predvajanja.
Swedish	
För RAV4 utrustad med äkta JBL Premium Sound.	ASL-funktionen (Automatic Sound Levelizer) ska ställas in på OFF (av) så att rätt lyssningsupplevelse kan uppnås. JBL-förstärkaren justerar ljudnivån och ljudspektrat precis så att bästa möjliga lyssningsupplevelse säkerställs när ljudnivån ökar med fordonets hastighet.
Turkish	
Gerçek JBL Premium Sound ile donatılmış olan RAV4 'da,	doğru dinleme performansını sağlamak için, ASL (Automatic Sound Levelizer) (Otomatik Ses Seviyesi Ayarlayıcısı) OFF'a getirilmelidir. JBL amplifikatörü, araç hızıyla birlikte gürültü seviyesi yükselirken, ideal dinleme ortamınızı gerçekleştirmek için ses seviyesini ve tayıfını ayarlayacaktır.
Ukrainian	
Для RAV4, який оснащений оригінальною системою JBL Premium Sound	Система ASL (Automatic Sound Levelizer, система автоматичного контролю звука) повинна бути вимкненою для забезпечення відповідного рівня якості звучання Підсилювач JBL автоматично скорегує рівень гучності та діапазон частот для забезпечення оптимальних звукових характеристик тоді, коли рівень шуму зростає під час руху автомобілю.