



Corolla Verso

Lift-up seat

Installation Instructions



Model Year: 2004

Part Number: LHD 08926-21816 / 08926-21817
RHD 08926-21814 / 08926-21815



Weight: 79 kg



Installation Time: 150 minutes

Manual reference number AIM 000770-0

Take off the Box

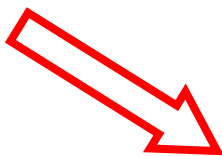

CAUTION!!















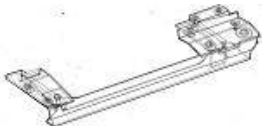

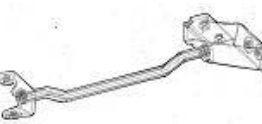









Note : No side air bag systems Mobility seat

※ All pictures mentioned on this I/M are for RHD vehicle.

※ Check all parts before installation.

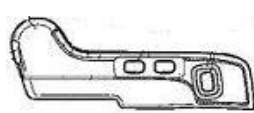
Parts List for Corolla Verso(LHD)













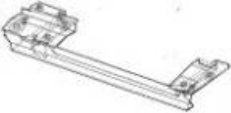











France Only

Part Number	Parts	Part Number	Parts
A × 1 C71001-D10M40 C71001-D10M50	 65	K × 13 90464-00620	 30 48
B × 1 C7120-D1600	 60	L × 8 91552-81025	 S=14 L=25 67 68
C × 1 C7120-D1610	 62	M × 7 90467-07055	73  74
D × 1 C8218-D1040	 29	N × 1 90467-06020	73 
E × 5 90119-10578	 60	O × 1 C9916-40001	 72
	 S14 × L27.5 61 62 63		
F × 1 68614-D1050	 5	× 1 01999-D1096	 French
G × 1 90105-08271	 S=12 L=20 5	× 1 01999-D1097	 English
H × 1 82161-D1550		P × 2 90467-10034	50 
I × 1 C8412-D1030	 42 50	R × 1 C6161-D1330	75 
J × 1 90982-08232	 47	S 2 × 74551-D1020	76  CRS défendu Siège tournant installé
U × 1 71811-D1070	 71	T 2 × 74596-D1020	77  Attention Siège tournant installé Côté passager pas d' Airbag latéral
V × 1 71148-D1070	 74	W × 1 71149-D1090	73 
		X × 1 74552-D1060	76  Caution Do not tilt your seat forward more than 10 degrees. Check the correct head restraint position.

※ Check all parts before installation.

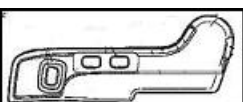
Parts List for Corolla Verso(RHD)

UK Only

Part Number	Parts	Part Number	Parts
A × 1 C71001-D1M60 C71001-D1M70	 65	K × 14 90464-00620	 30 48
B × 1 C7120-D1620	 57	L × 8 91552-81025	 S14 × L25 67 68
C × 1 C7120-D1630	 62	M × 7 90467-07055	73 74 
D × 1 C8218-D1040	 29	N × 1 90467-06020	73 
E × 5 90119-10578	 S14 × L27.5 57 62	O × 1 C9916-40001	72 
F × 1 68614-D1050	 5	P × 2 90467-10034	50 
G × 1 90105-08271	 S12 × L20 5	Q × 1 01999-D1098	
H × 1 82161-D1560		R × 1 08926-21823	58 
I × 1 C8412-D1030	 42 50	R × 1 C6161-D1330	75 
J × 1 90982-08232	 47	S 2 × 74551-D1010	78  78 CRS not allowed Mobility seat installed
U × 1 71812-D1110	 71	T 3 × 74596-D1010	79 80  80 WARNING SRS passenger side airbag not available. Mobility seat installed
V × 1 71148-D1080	 74	W × 1 71149-D1100	73 
		X × 1 74552-D1050	76  76 Caution

Tool

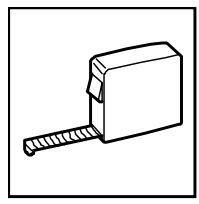
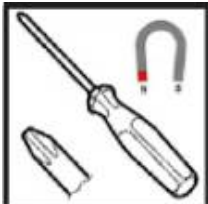
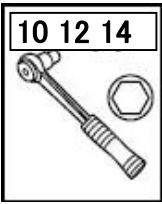

* Torque Wrench is also required

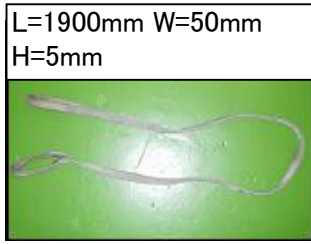

PROTECT COVER

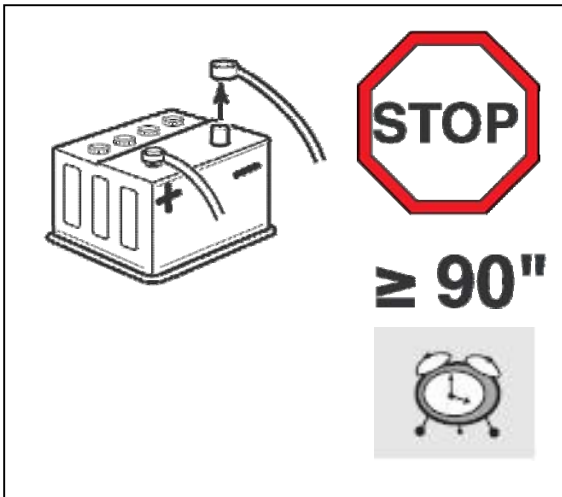

Airbag

Alter the door divergence on passenger side.

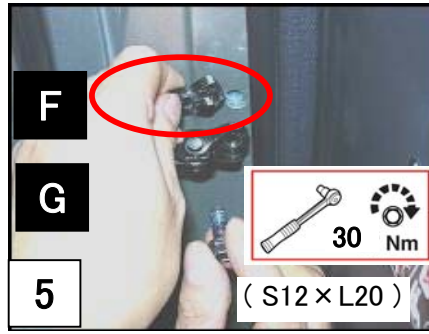

1. Remove the door check arm bolt.

2. Put the spacer between the body and the door check arm, and fix them.

Remove the OE seat.

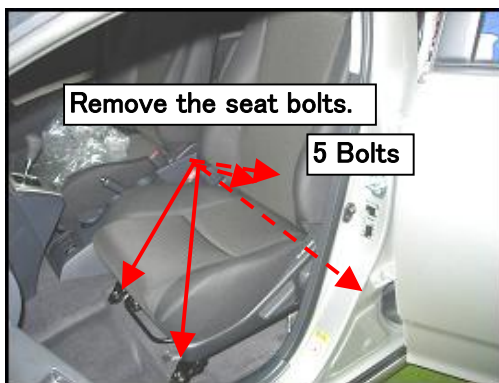

Under the Seat Cushion



or



Remove the OE Parts.

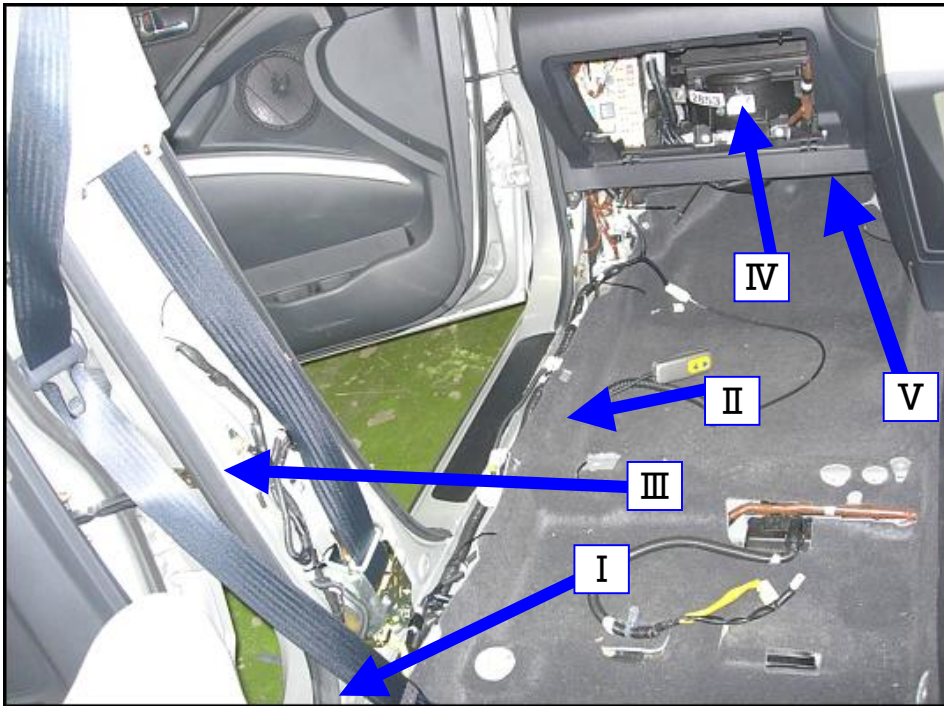

1. Remove the scuff plate. (rear seat)

2. Remove the scuff plate. (passenger seat)

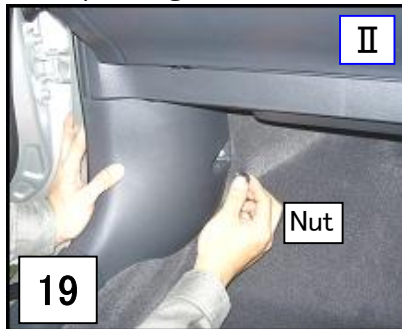
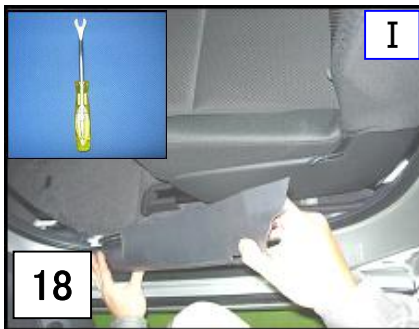

3. Remove the front weather strips

4. Remove the rear weather strips.

5. Remove the B pillar lower trim.

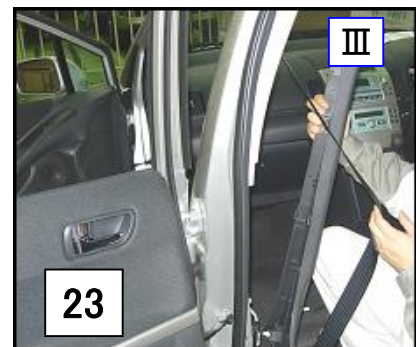

6. Remove the glove compartment.

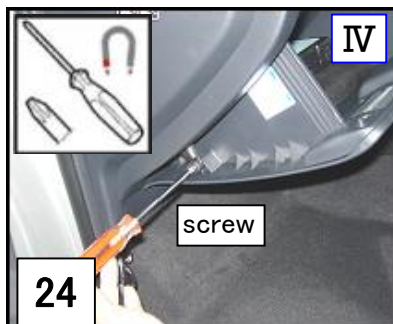

⑦ Remove the glove compartment under cover.

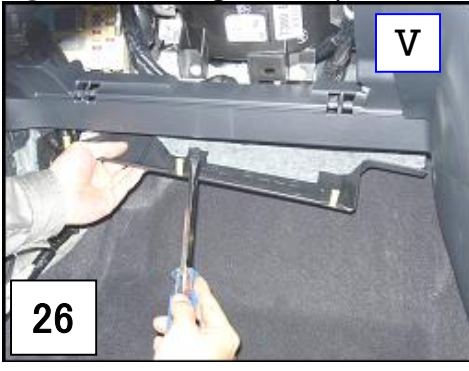

⑧ Remove the under cover on driver's seat side.

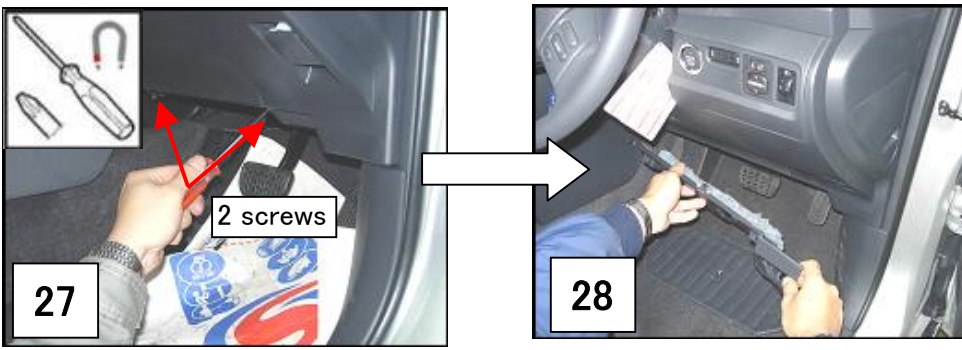

Wire Harness Configuration

LHD is the reverse.

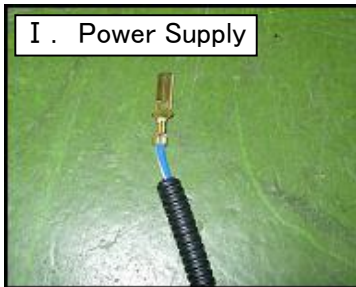
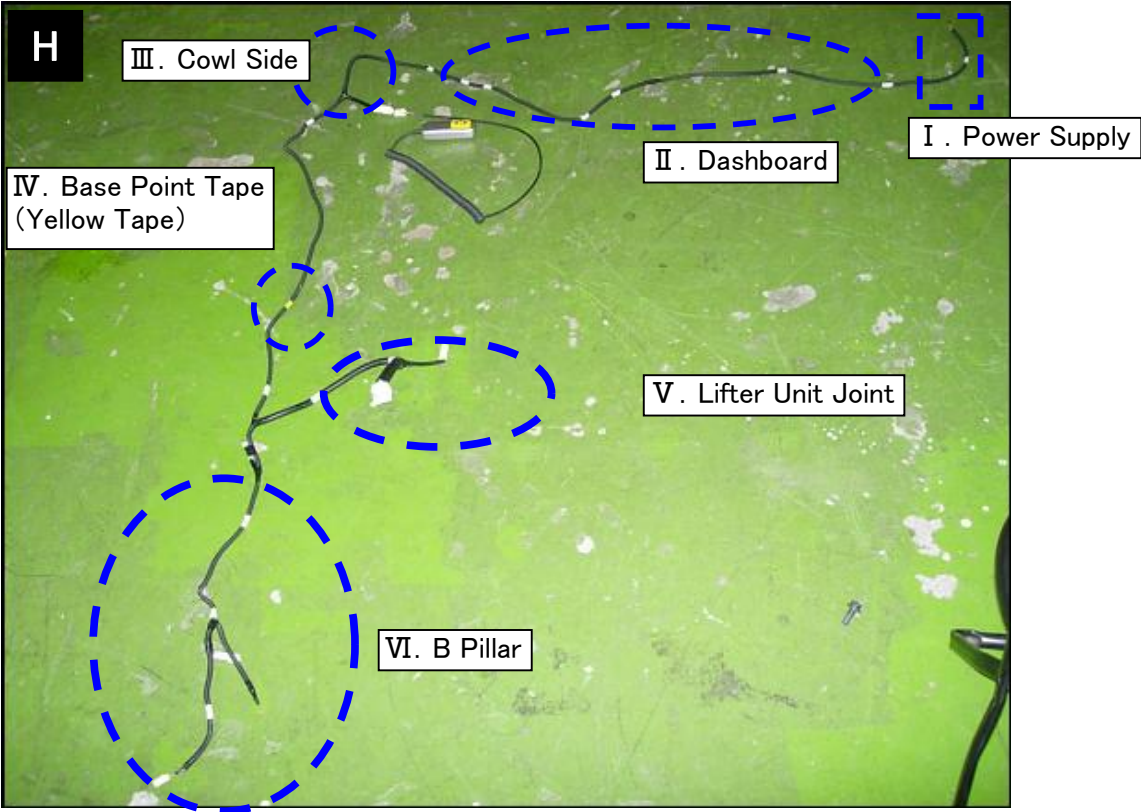

1. Fit the Dummy Connector into the Air Bag Connector.
(Tie up the connector with the wire harness.)



2. Insert the wire harness into the floor carpet and pull out it along the cross member.

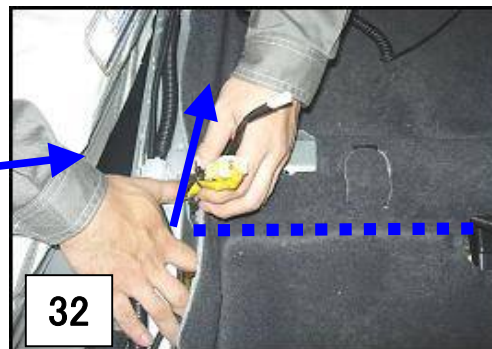
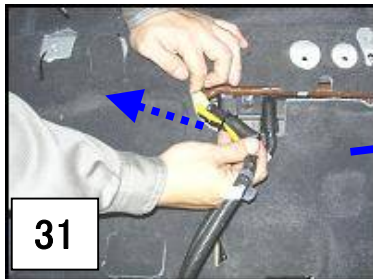

3. Clamp the yellow tape point (base point).

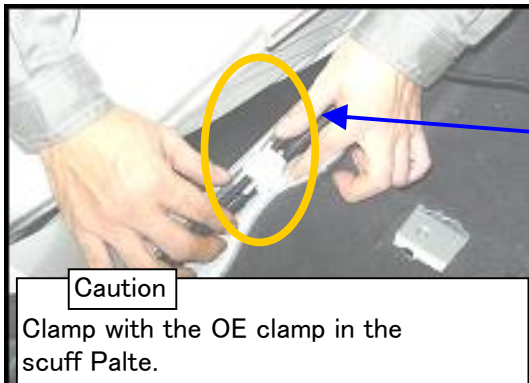

Caution
Clamp with the OE clamp in the scuff Palte.

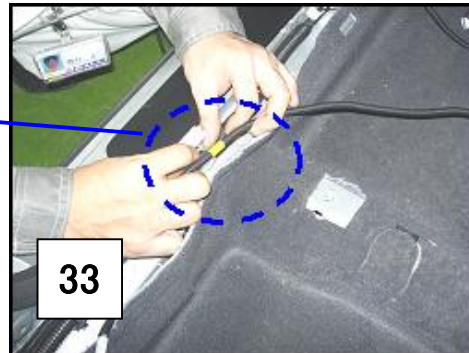

4. Fit the OE seat buckle connector into the wire harness.



5. Pull out the lifter connector.

- 1) Cut in the floor carpet.
- 2) Pull out the lifter harness.

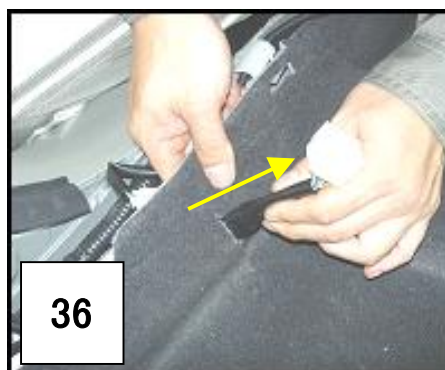

6. Fit the B Pillar harness.

- 1) Fit the courtesy switch harness.

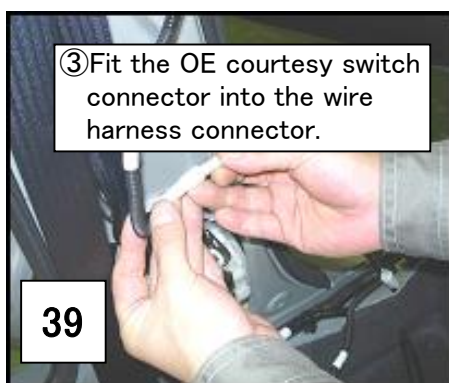
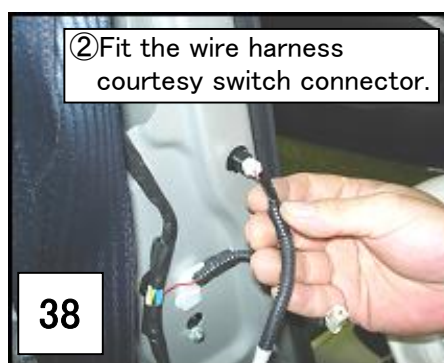
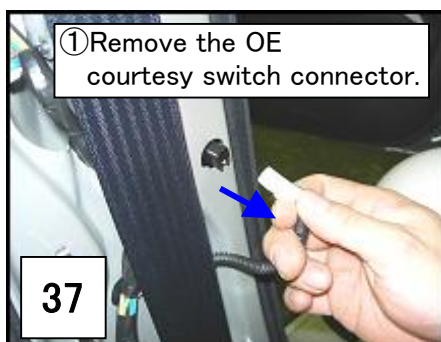

- 2) Fix the wire harness body earth and the OE body earth together.



7. Pull the wire harness forward and clamp it.

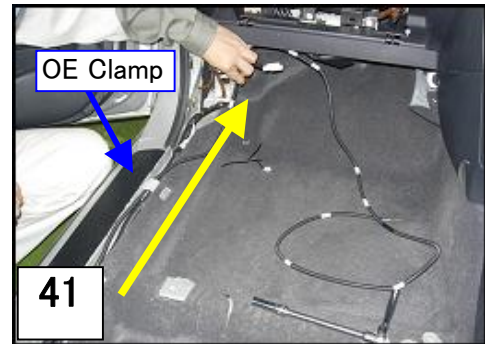

8. Fit the up-down switch (coiled cable) connector into the wire harness.



9. Pass the wire harness to the driver's seat side.

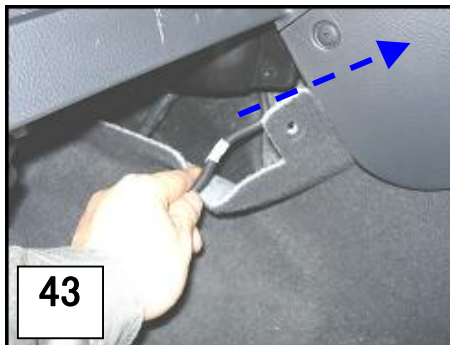

10. Remove the fuse cover.



11. Insert the power supply terminal.

UK RHD

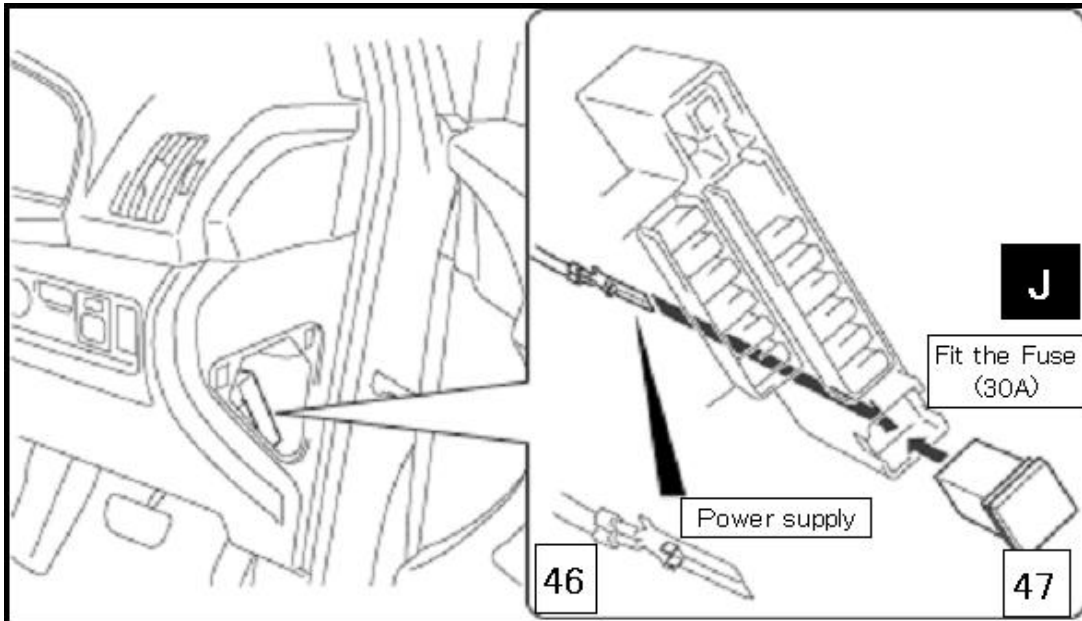

Caution

- Insert the power supply terminal into the back of the fuse box.
- Be careful of the direction of the terminal.

France LHD

■ Insert the power supply terminal.

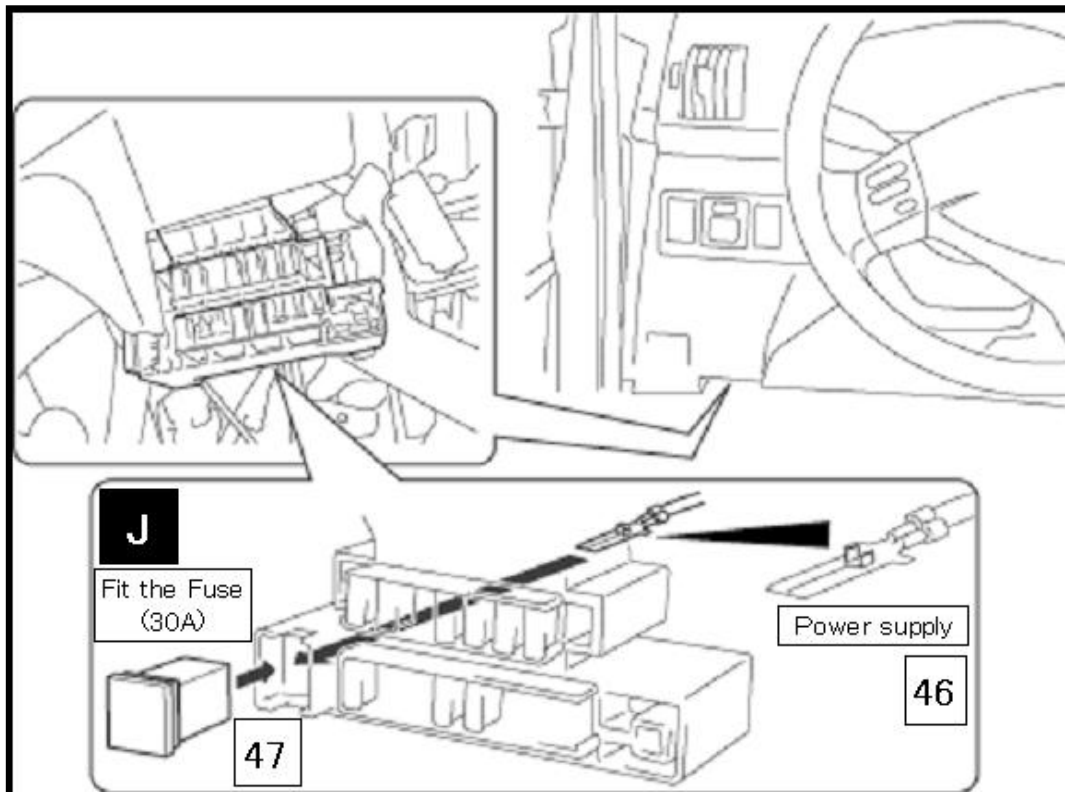

Caution

- Insert the power supply terminal into the back of the fuse box.
- Be careful of the direction of the terminal.

12. Tie up the wire harness.

48

K

Caution

Tie up the **white tape point** of the wire harness.

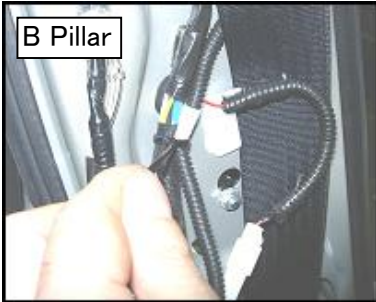

Caution

Keep the wire harness from touching the seat belt.

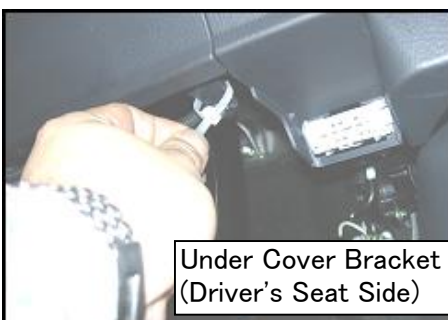
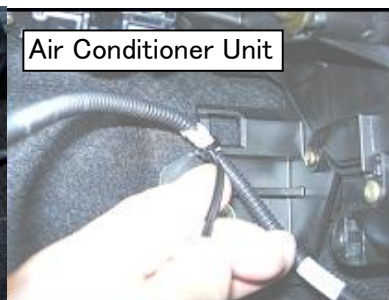

Install the switch holder.

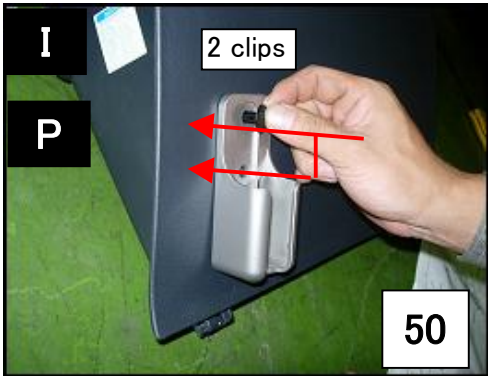
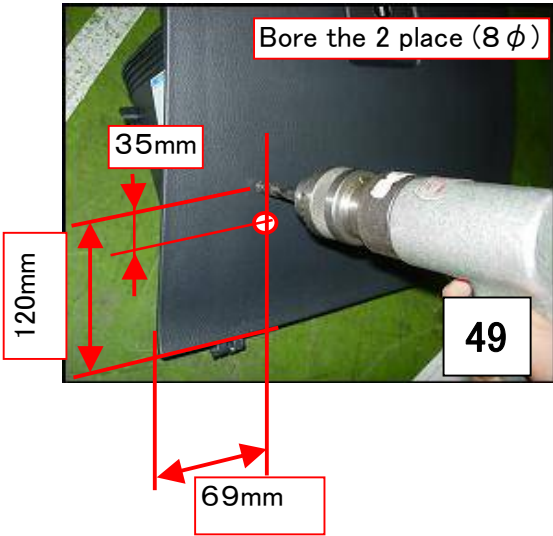

Cut off the carpet. (oblique line part)

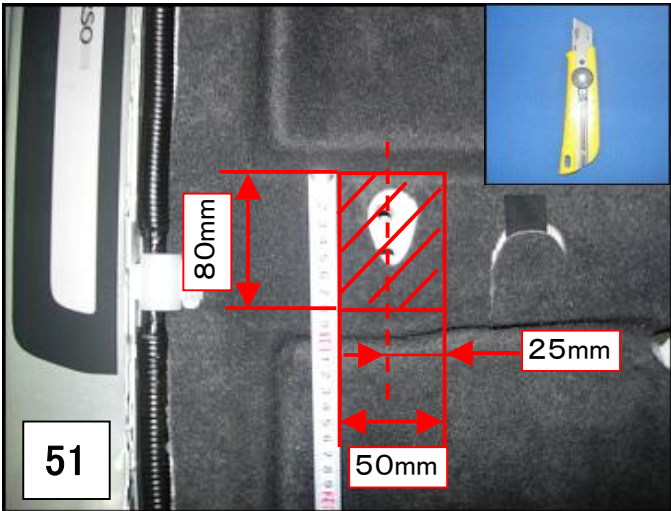

Lift-Up Sear Installation

Exchange the yaw rate sensor.

UK ONLY (RHD)

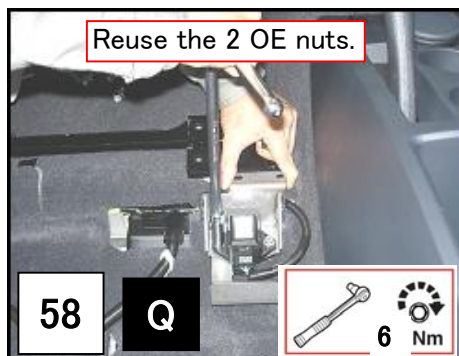
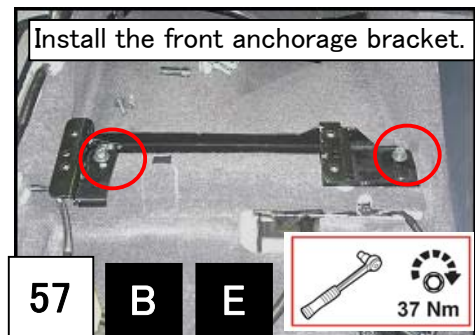
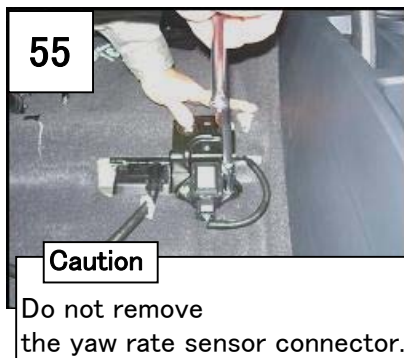
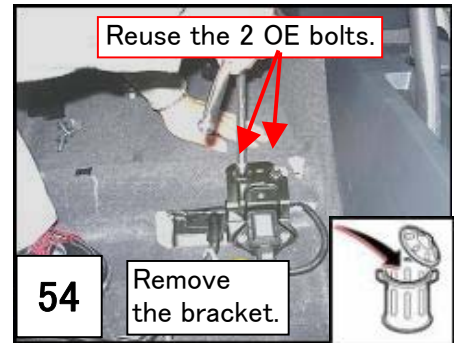
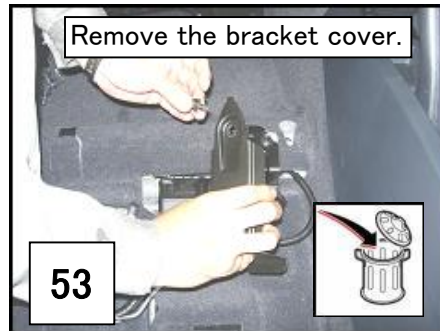
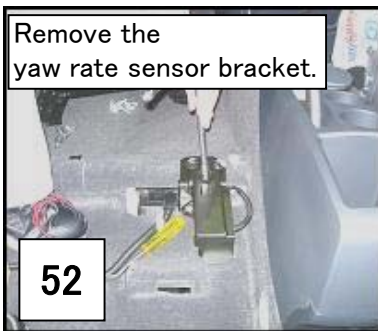

1. Install the anchorage bracket.

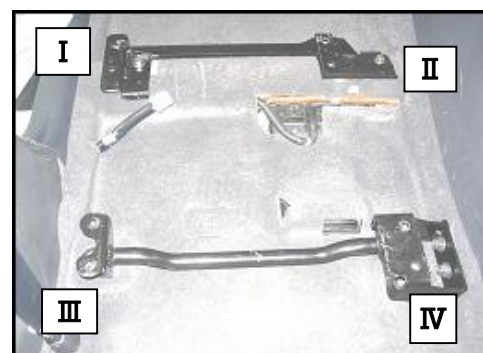
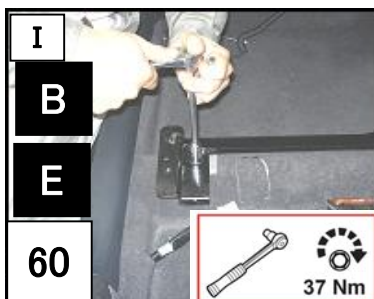

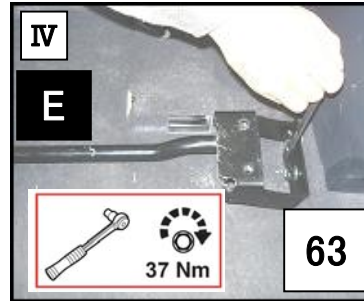

2. Install the lift-up unit in the vehicle.

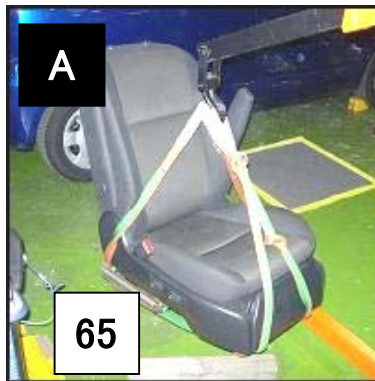

Caution

Be careful of the balance when hanging the seat with the belt.

3. Fit the lift unit connector.

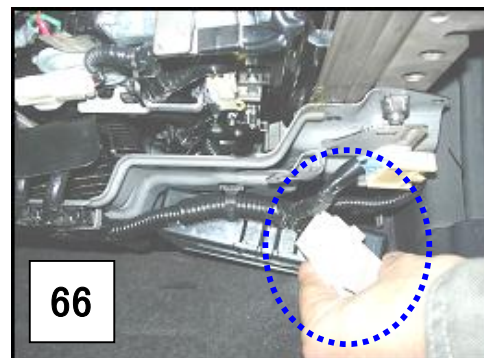

4. Tighten the 3 bolts provisionally.

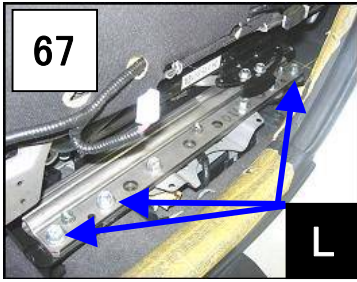

5. Reconnect the battery and rotate the lifter.

6. Tighten the 5 bolts provisionally.

Caution
Tighten the bolts lightly at 67 68

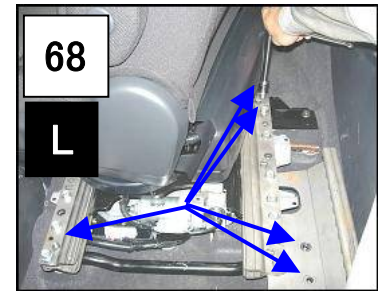

7. Tighten the 3 bolts of outside

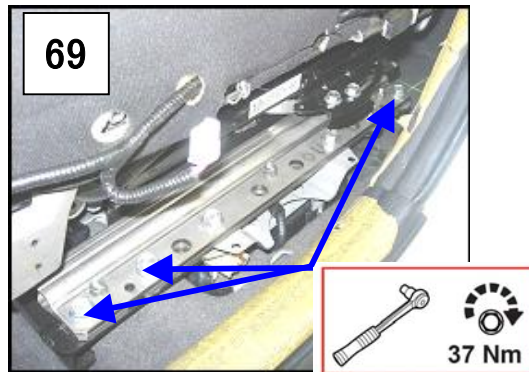

8. Rotate the seat and install the lift-up unit and the anchorage bracket. (5 bolts)

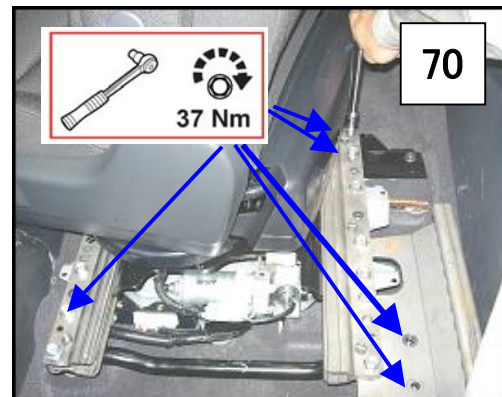

9. Install the outside shroud. (3 connectors and 1 screw)

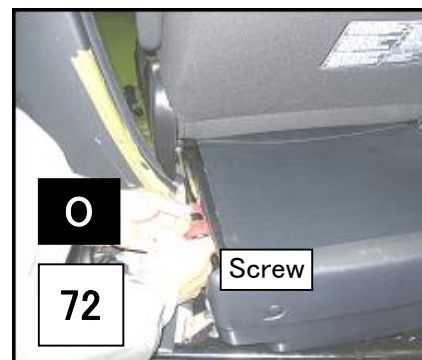
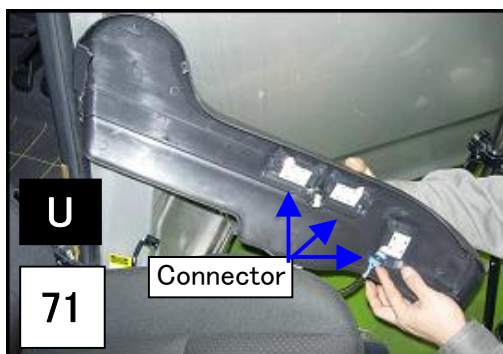

10. Install the inside under cover with clips.
(M clip × 3 · N clip × 1)

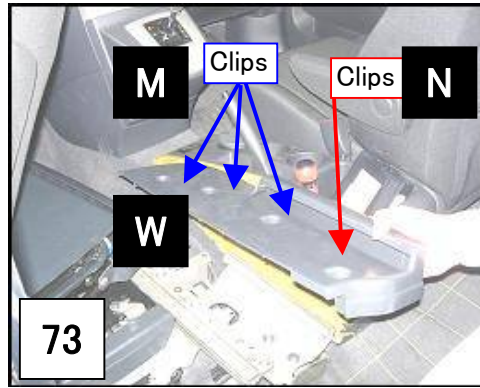

11. Install the outside under cover with clips.
(4 clips)

Caution

- ① Insert the cover from the back of the lift up seat.
- ② Use the clips to fix.

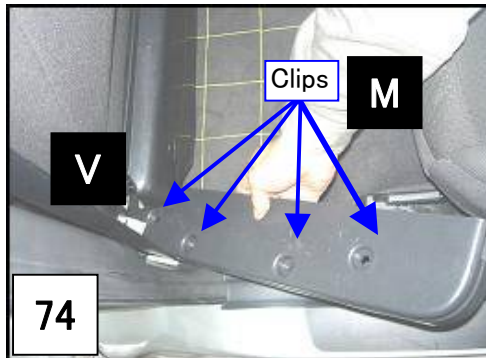

12. Put the caution label.

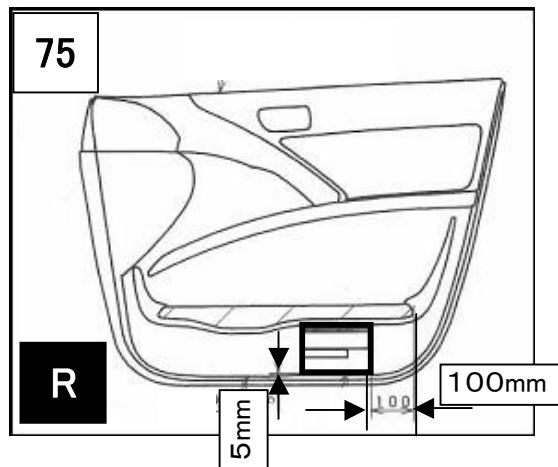

- Install the covers again.
- Confirm if the air bag warning lamp operates normally when the engine is on.
- Confirm if the lift-up seat moves smoothly.

Label putting position (CRS or SRS)

France Only

Put CRS **S** and SRS **T** stickers as below.



Two places

Manual de propriétaire

○ Put the label on O/M of base Vehicle.

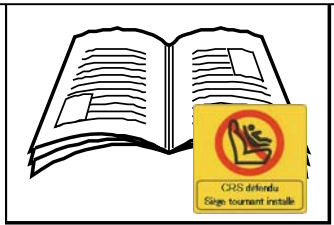

Système de retenu des occupants Siège enfants



Two places

Manual de propriétaire



Système de retenu des occupants Airbag latéraux

○ Put the label on O/M of base Vehicle.

Label putting position (CRS or SRS)

UK Only

Put CRS **S** and SRS **T** stickers as below.



78

•Put on Side of Instrument Panel



Two places

Owners Manual

○ Put the label on O/M of base Vehicle.

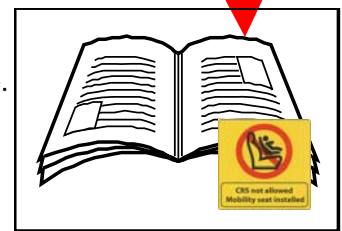

Chapter "occupant restraint systems"
Paragraph "Child restraint"

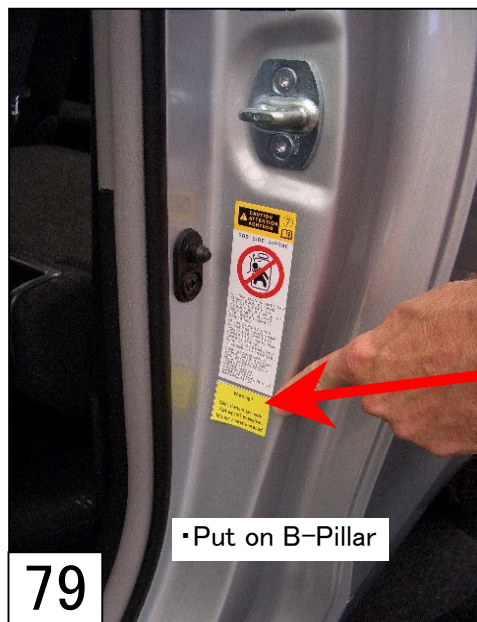

79

•Put on B-Pillar



Three places

Owners Manual

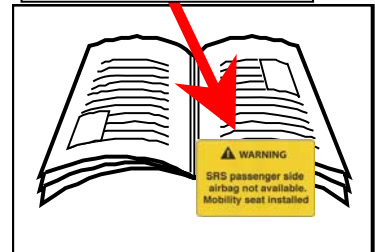

Chapter "occupant restraint systems"
Paragraph "SRS side airbag"

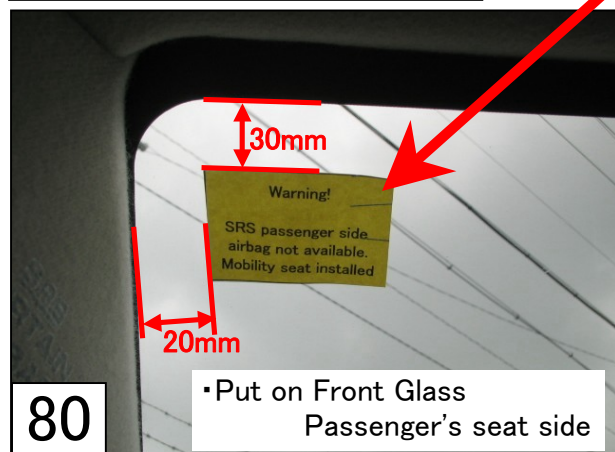

80

•Put on Front Glass Passenger's seat side

○ Put the label on O/M of base

