

HANDS-FREE CAR KIT
KFZ FREISPRECHEINRICHTUNG
HANDENVRIJE CAR KIT
LE KIT MAINS-LIBRES

THF 10

TOYOTA CELICA

INSTALLATION MANUAL-EINBAUANLEITUNG-MANUEL D'INSTALLATION-MONTAGE HANDLEIDING

LHD



CELICA

LHD

PARTNUMBER: THF 10

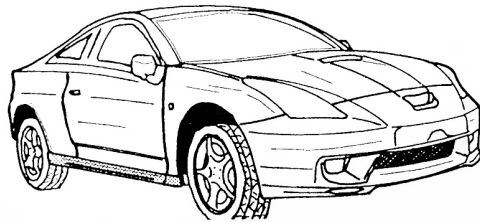

HANDS-FREE CAR KIT
KFZ FREISPRECHEINRICHTUNG
HANDENVRIJE CAR KIT
LE KIT MAINS-LIBRES

KIT CONTENT - STÜCKLISTE - CONTENU - KIT INHOUD

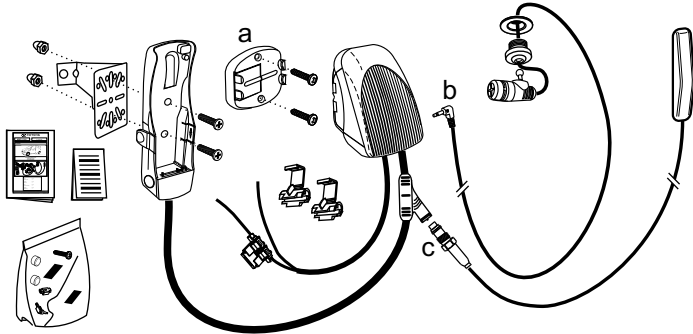

Weight: 0,54 kg
Installation time: 1 h

Gewicht: 0,54 kg
Einbauzeit: 1 h

Poids: 0,54 kg
Temps d'installation: 1 h

Gewicht: 0,54 kg
Installatie tijd: 1 h

INSTALLATION MANUAL-EINBAUANLEITUNG-MANUEL D'INSTALLATION-MONTAGE HANDLEIDING

Page: 1/13

TOOLS/WERKZEUGE/OUTILS/WERKTUIGEN

MODEL CODE: ZZT23*L-BLF**W







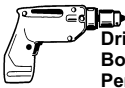

☺	☹
VEHICLE OPTION/FAHRZEUG OPTION/OPTION VEHICULE/VOERTUIG OPTIE	
1	1
2	2
3	3
4	4
5	5
6	6
7	7
8	8
9	9
10	10

ACCESSORY/ZUBEHÖR/ACCESSOIRE	
1	1
2	2
3	3
4	4
5	5
6	6
7	7
8	8
9	9
10	10

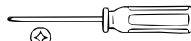
SAFETY PRECAUTION/SICHERHEITSMASSNAHME/PRECAUTIONS DE SECURITE/VEILIGHEIDVOORZIENINGEN

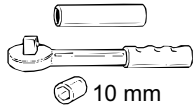
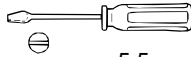
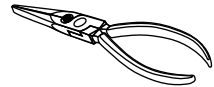
	Step/Punkt/Point/Stap 3/20		Step/Punkt/Point/Stap
	Step/Punkt/Point/Stap		Step/Punkt/Point/Stap

TOOLS/WERKZEUGE/OUTILS/WERKTUIGEN

 <p>Drill Bohrmaschine Perceuse Boormachine</p>	 <p>Ø 3 mm Bits Ø 3 mm Bohrer Ø 3 mm Forets Ø 3 mm Boor</p>	 <p>Ø 15 mm Bits Ø 15 mm Bohrer Ø 15 mm Forets Ø 15 mm Boor</p>
 <p>Philips 2</p>	 <p>PLASTIC CLEANER</p> <p>Cleaner Entfetter Dégrossiseur Onvetter</p>	 <p>10 mm</p>
 <p>5,5 mm</p>		 <p>Pencil Stift Stylo pointe Potlood</p>
<p>Gume tape Klebeband Ruban adhésif Kleefband</p> 		

INFO

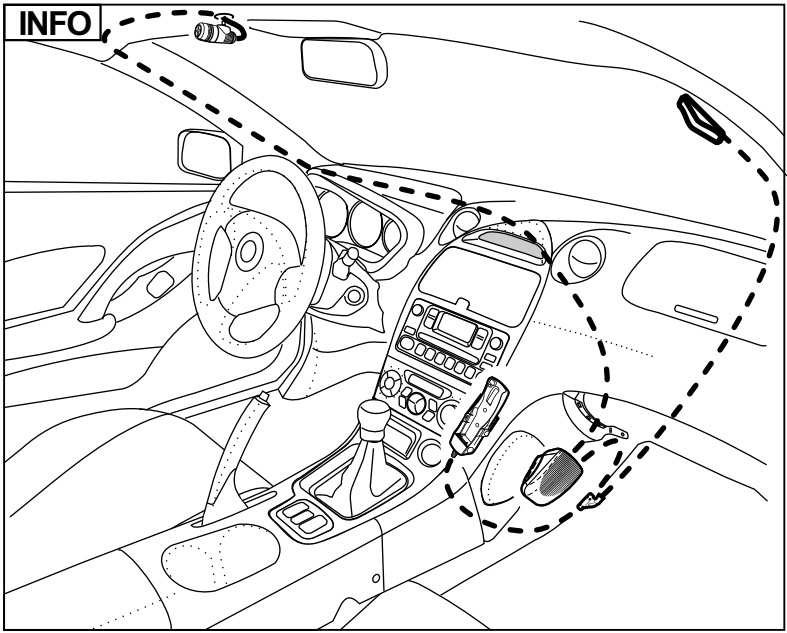

1

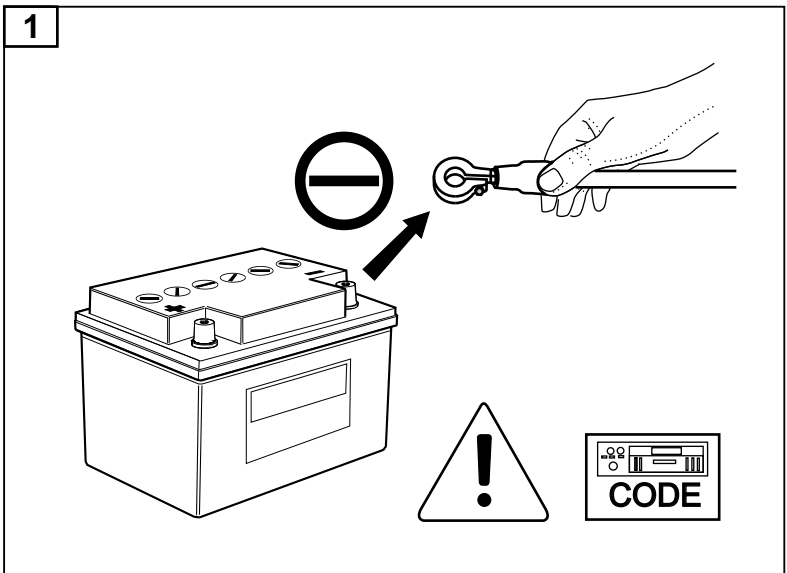

2a

without sunroof

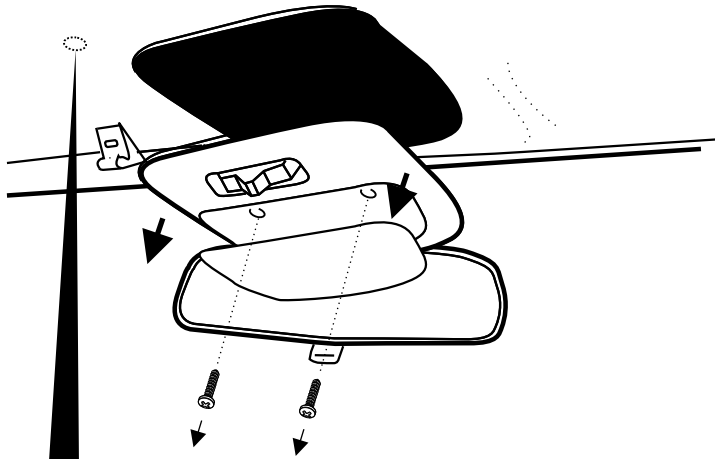

3a

without sunroof

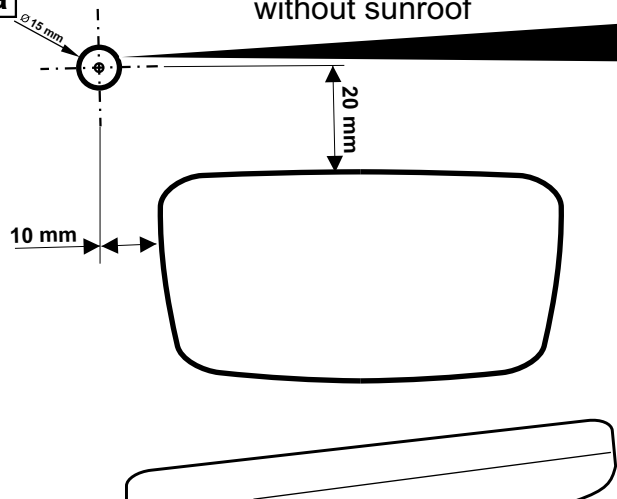

2b

with sunroof

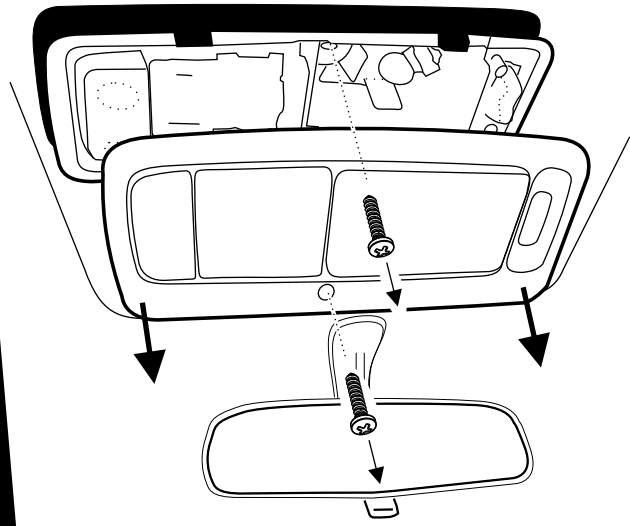

3b

with sunroof

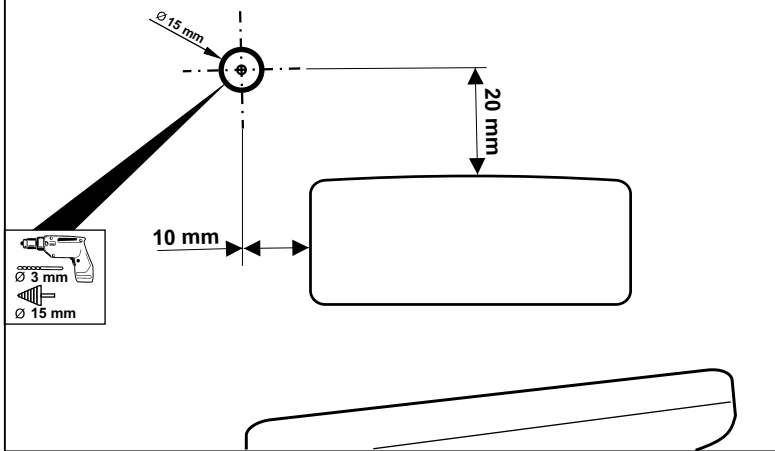

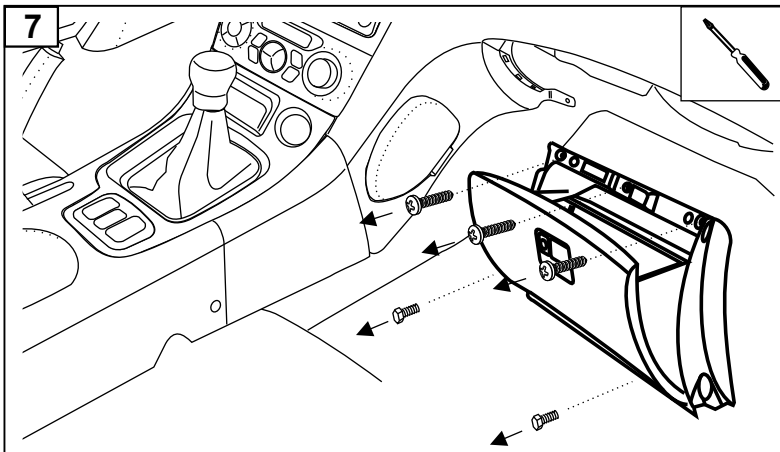
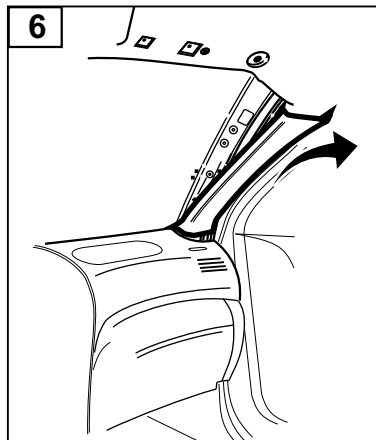
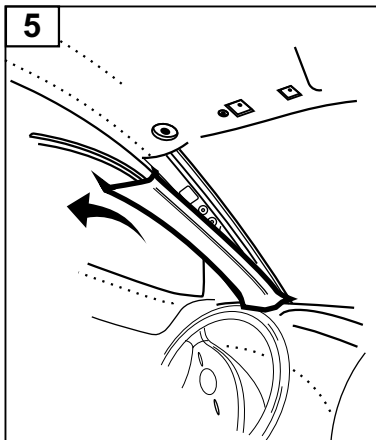
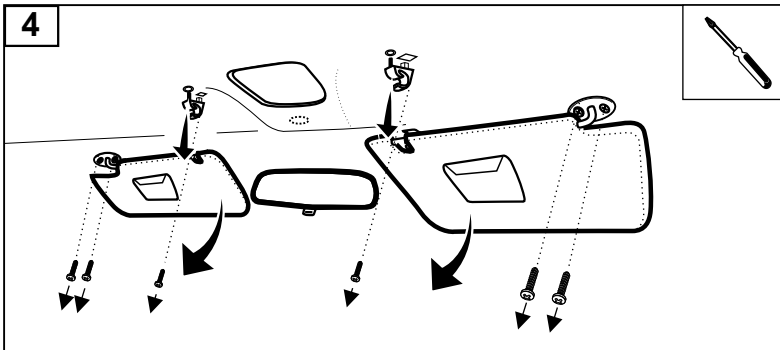

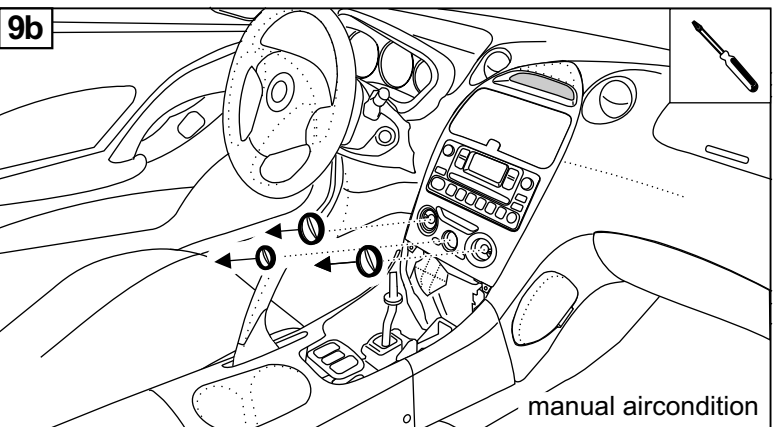
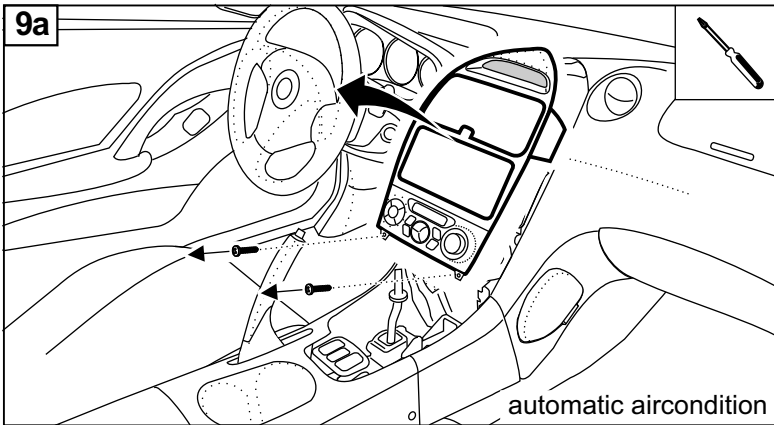
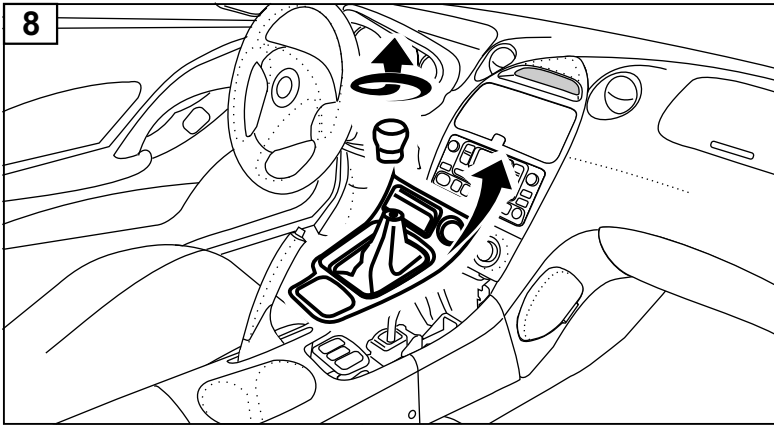

10b

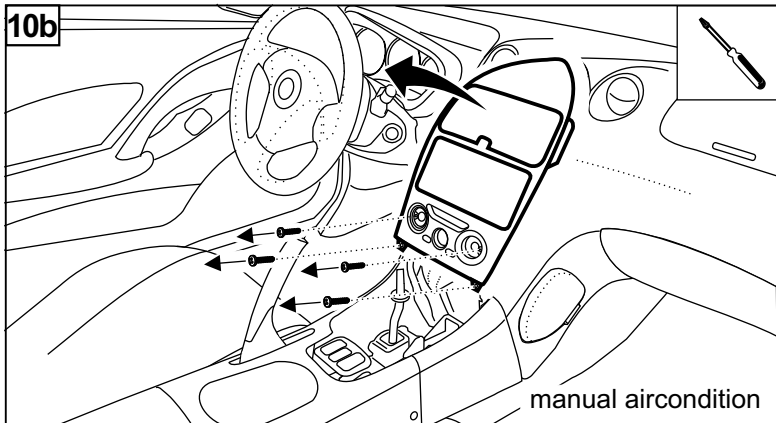

manual aircondition

11

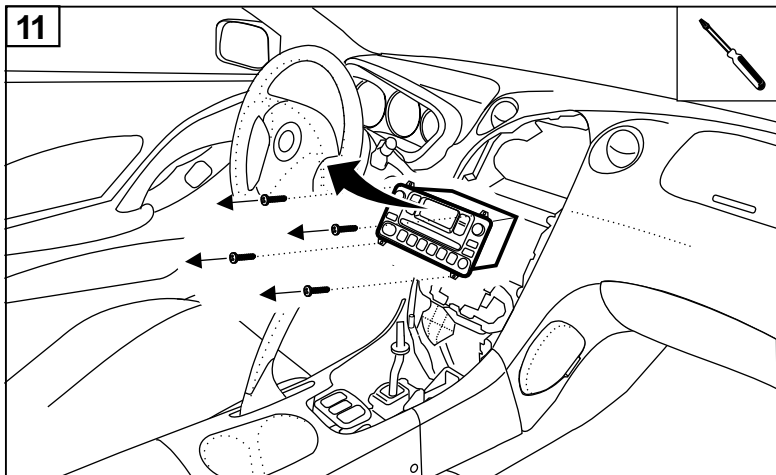

12

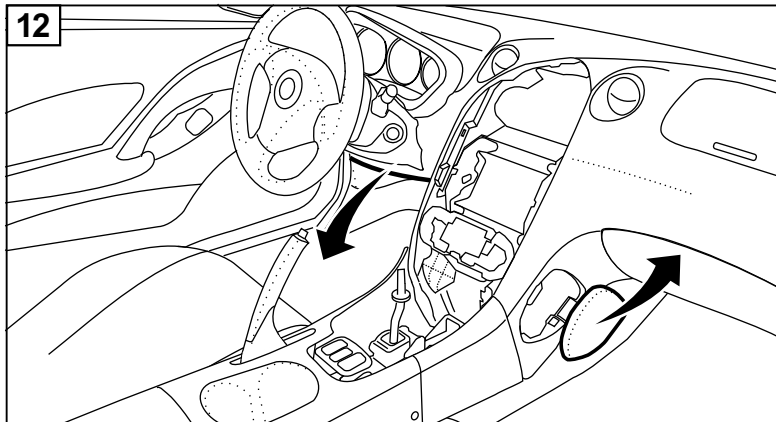

13

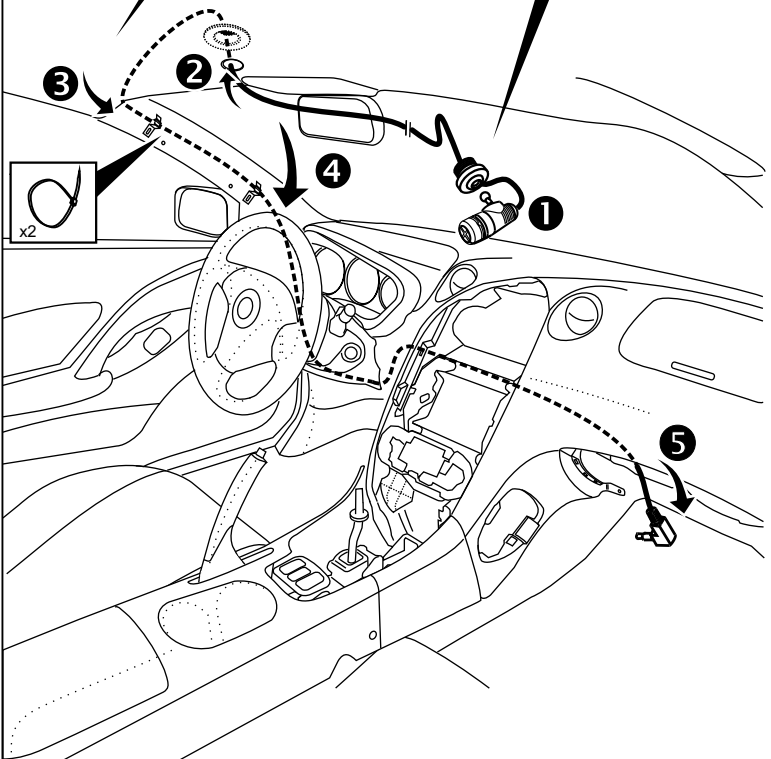
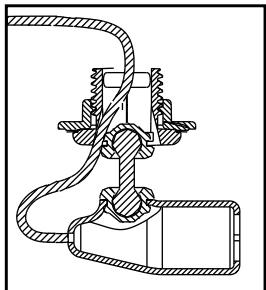
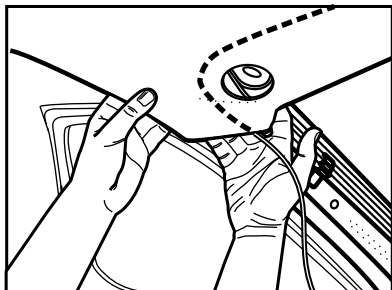

14

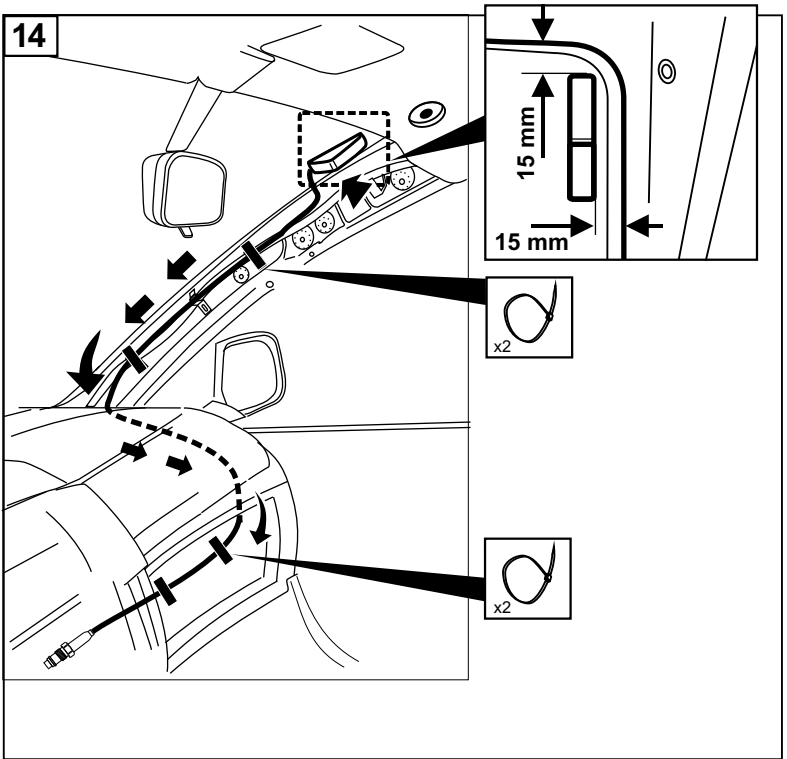

15

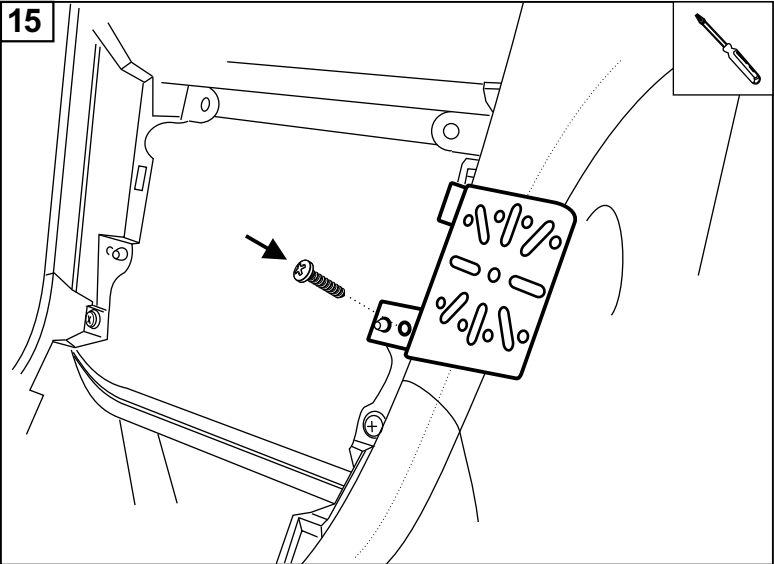

16

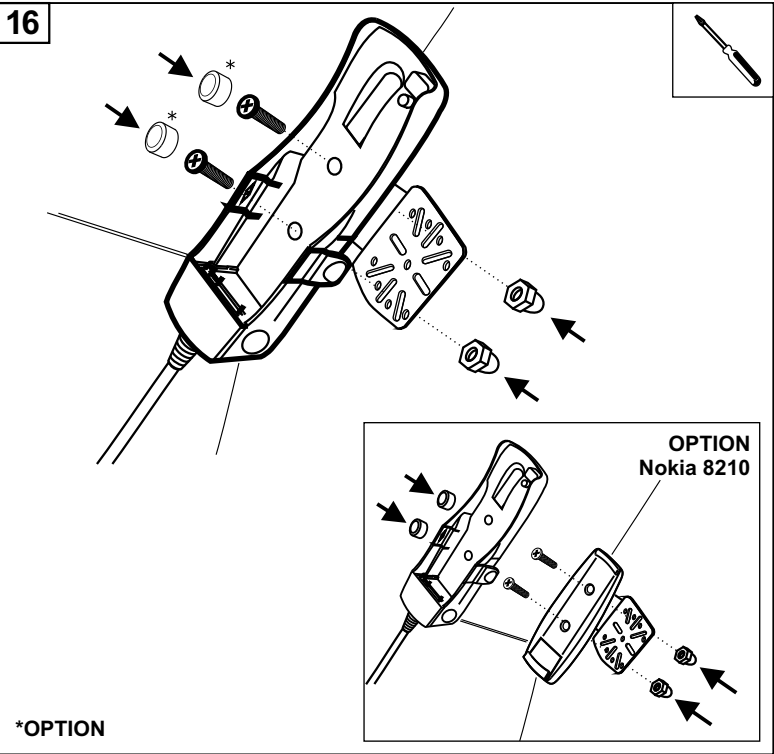

*OPTION

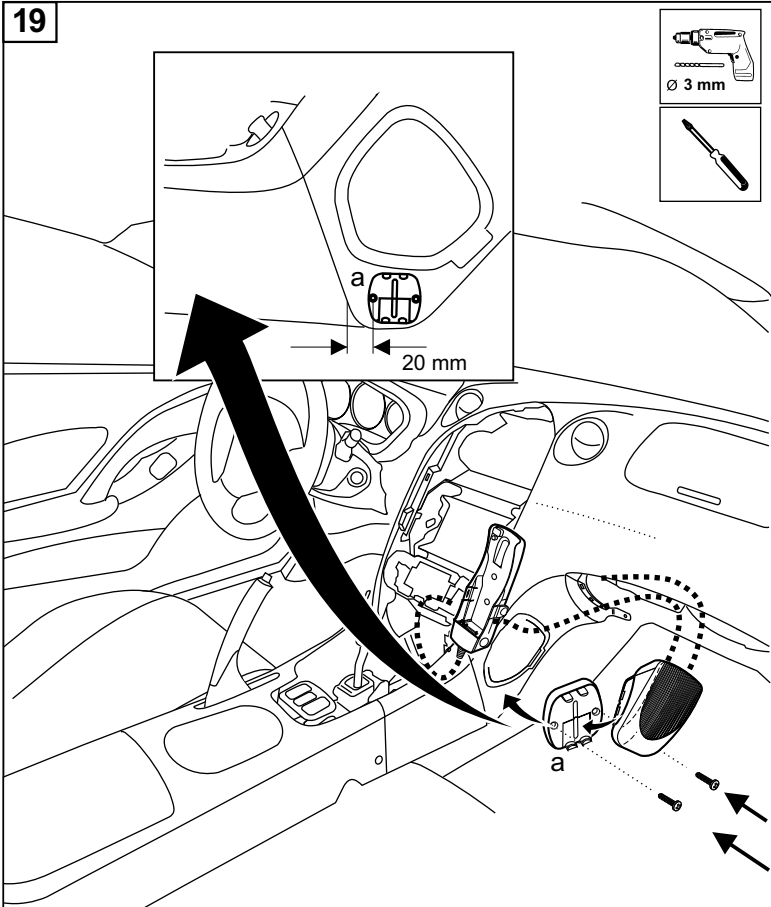
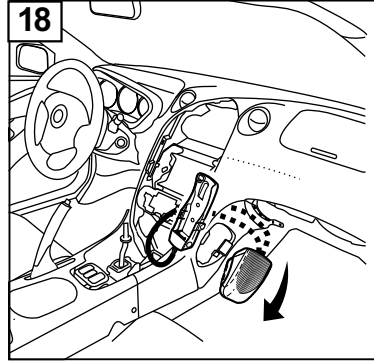
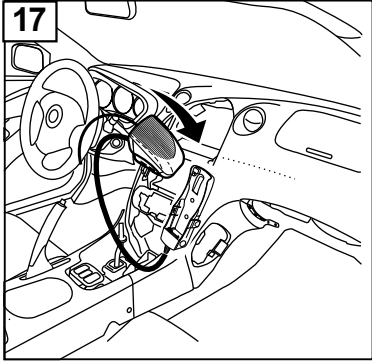

20

