



# SHERIFF

## TOYOTA RAV 4

### Under Run Protective Shield Installation Instructions



Model Year	2006
Vehicle Code	ACAxxxL-*-W
Part Number	PZ4AL- 08760- 00
 Weight	17Kg
 Installation Time	30min
Manual reference number	AIM 000-871-1

Part number: PZ4AL-08760-00

**A**

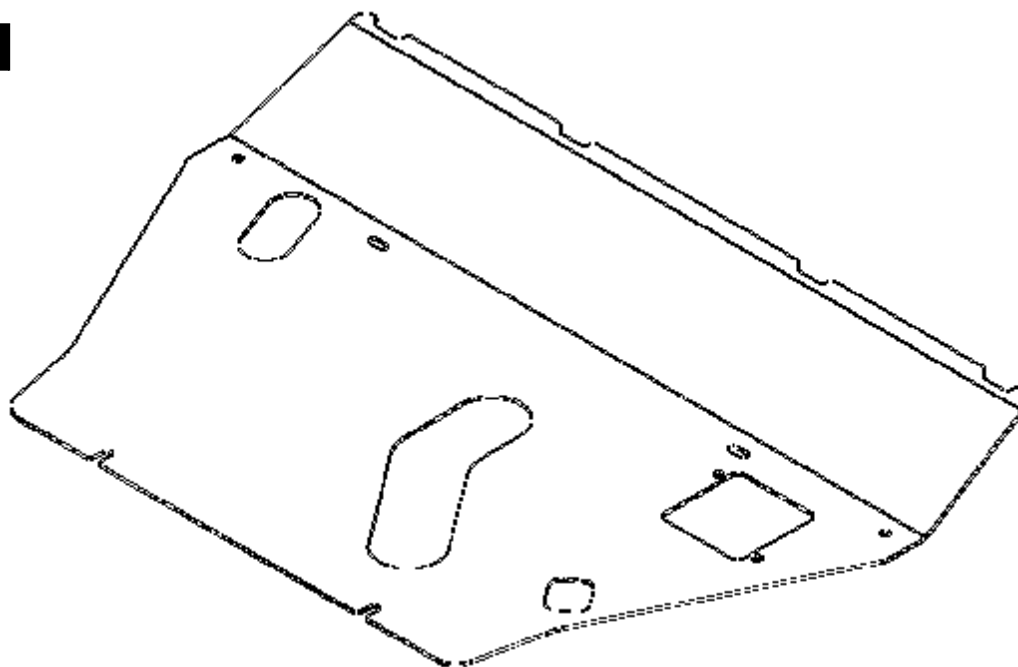

PZ4AL- 08760- 60

**B1**

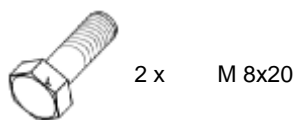

**B2**

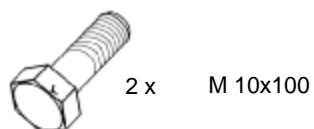

**C1**

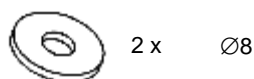

**C2**

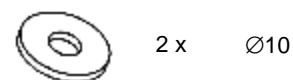

**D**



**E**

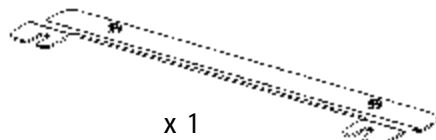

**F**



**G**

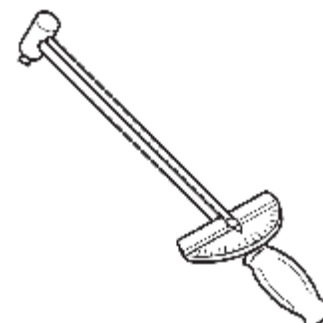
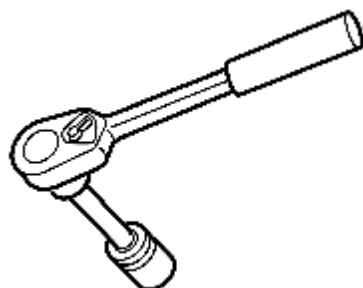

Part number:  
PZ4AL- 08760- 00

Issue:  
0

Date:  
19/12/06

Manual reference number:  
AIM 000-871-1

Page:  
2/4

1

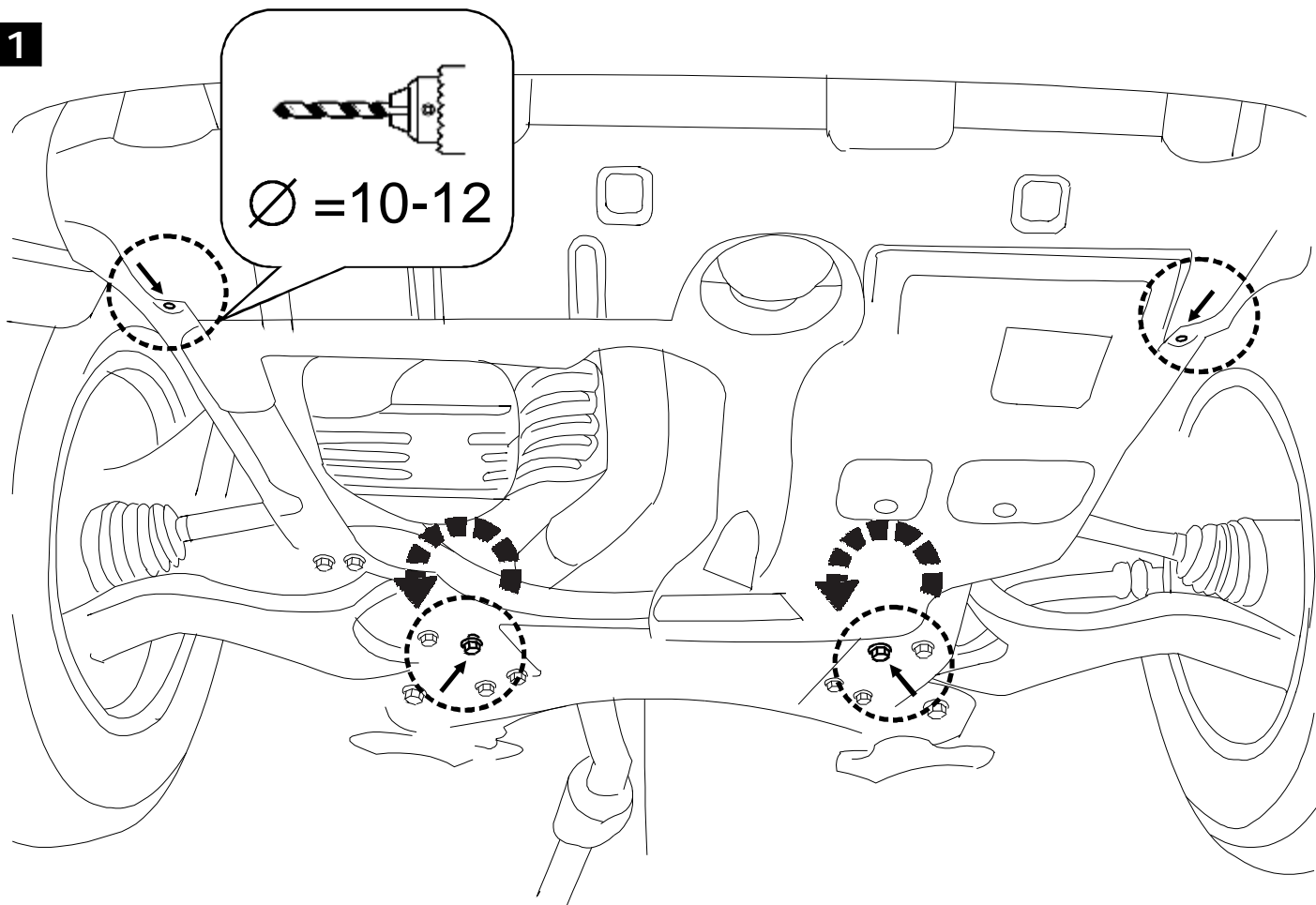

2

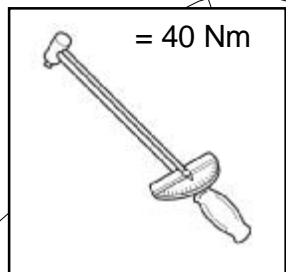

FWD

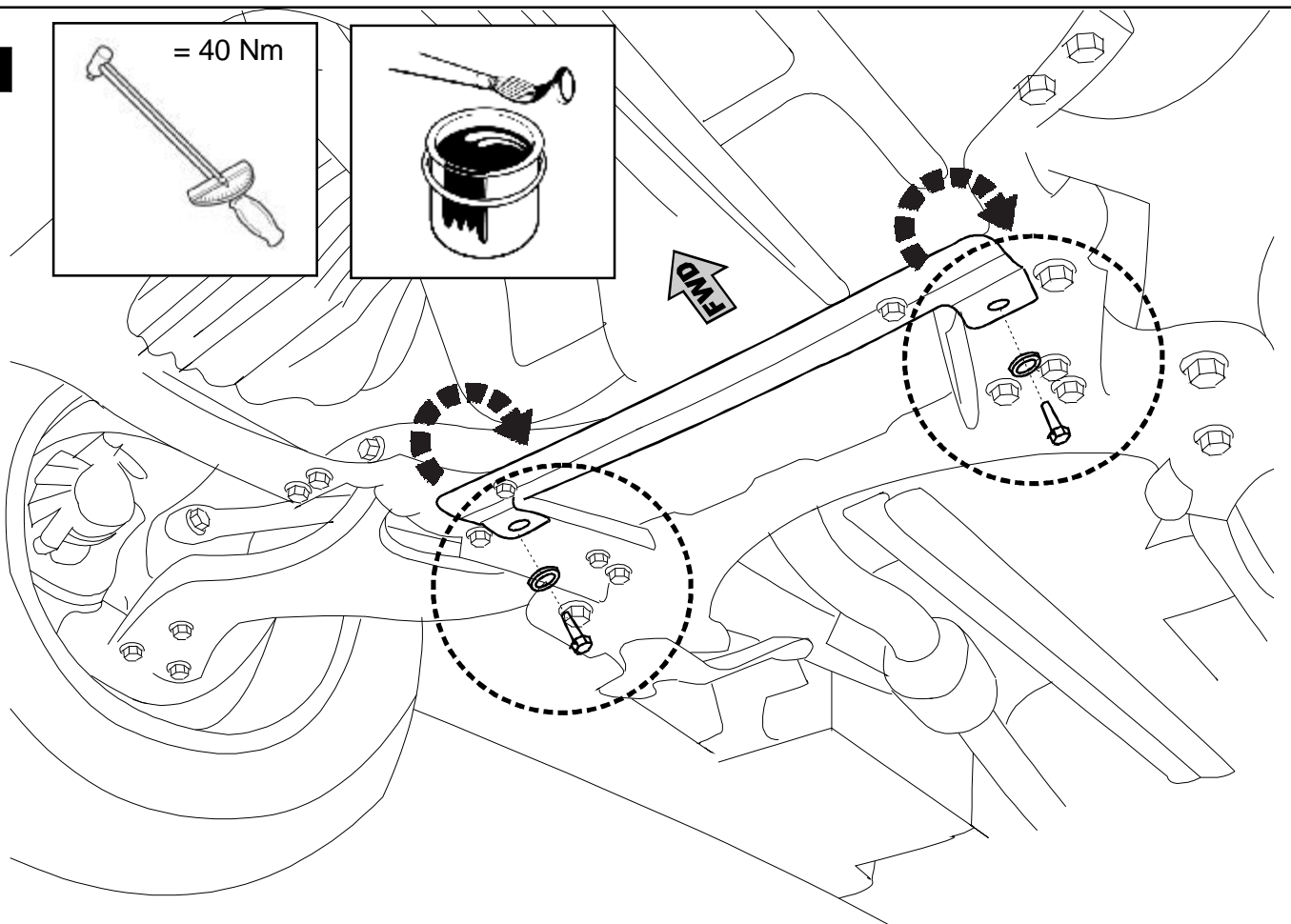

3

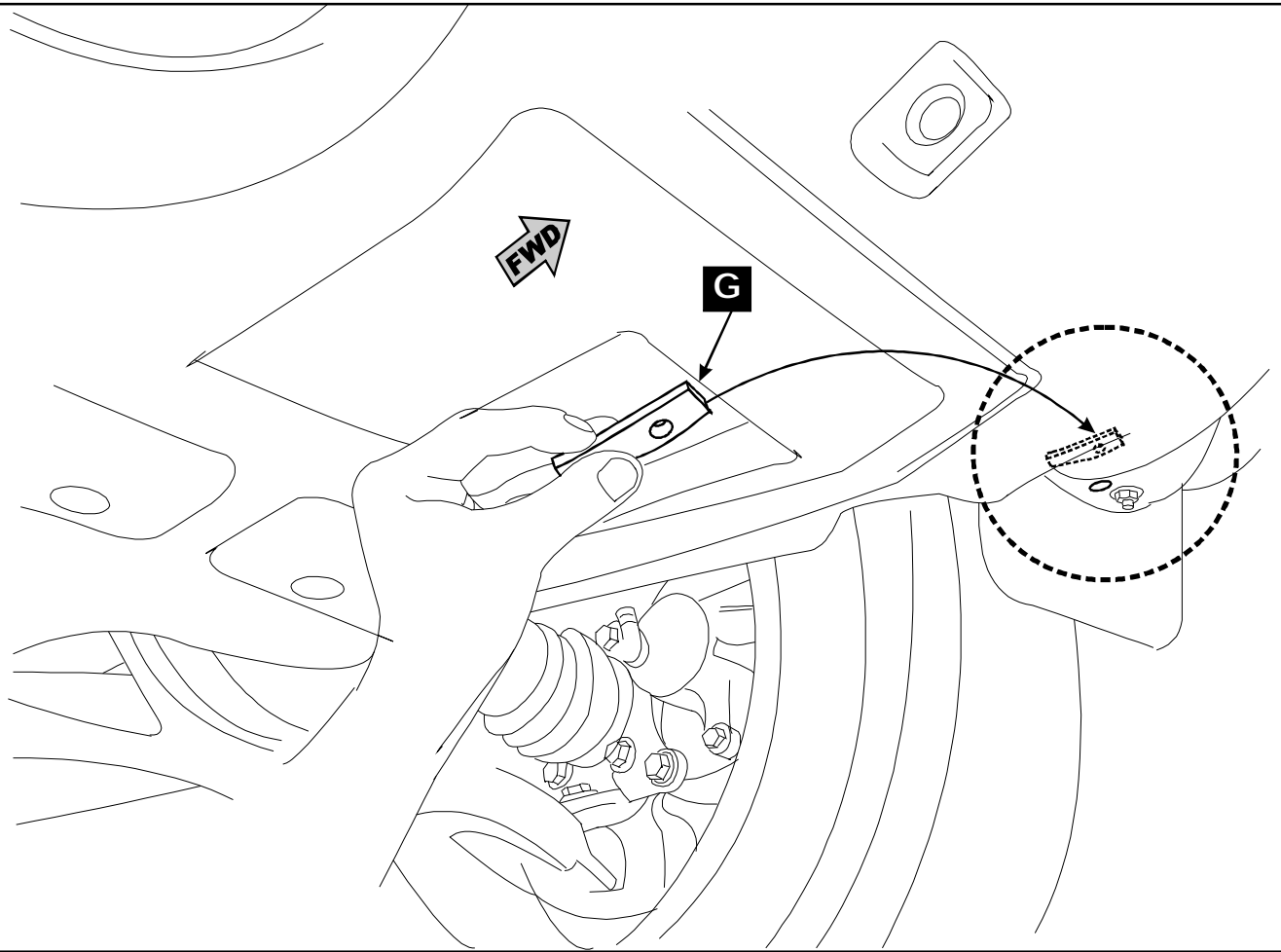

4

