

Land Cruiser 120

Seat Heaters

Installation instructions



Model year: 2002/09

Vehicle code: **J12*L-G**E*W

Part number: PZ4AG-19060-85

 Weight: 1,16 kg

 Installation time: 4,00 hours or +1,50 hours to leather installation

Manual reference number: AIM 000 961-1

Revision Record

Rev. No.	Date	Page	Picture	Update	New	Deleted
1	27.03.2013	31, 32	55, 57	x		

- GB**
- Expert Fitment Required.
 - Disconnect the battery earth cable.
 - To avoid damage to the wiring harness, ensure contact with sharp edges is prevented.
 - Install parts as shown on illustrations.
 - Re-connect battery.
 - Re-fit panels, ensure that the wiring harness and other components are neatly and securely located.

- E**
- Montaje sólo por el concesionario.
 - Desconectar el cable de masa de la batería.
 - A efectos de evitar desperfectos en el aislamiento del cable, hay que evitar el contacto con aristas cortantes.
 - Montar las piezas tal como se indica en las figuras.
 - Vuelva a conectar la batería.
 - Volver a colocar los paneles; preste atención a que el mazo del cable y las demás piezas tengan la posición correcta y precisa.

- I**
- E' necessario in officina specializzata.
 - Staccare il cavo di massa dalla batteria
 - Allo scopo di evitare danni all'isolazione dei cavi, evitare di metterli a contatto con spigoli acuti.
 - Montare le parti secondo quanto rilevabile delle illustrazioni.
 - Riconnettere la batteria.
 - Rimettere in posizione i pannelli; far ben attenzione che il fascio di cavi e le altre parti siano state posizionate con esattezza e nella dovuta maniera.

- NL**
- Montage door vakman nodig.
 - Massakabel van accu losmaken.
 - Ter vermindering van beschadiging aan de isolatie van de elektrokit dient contact met scherpe kanten te worden vermeden.
 - Delen overeenkomstig afbeelding monteren.
 - Accu weer aansluiten.
 - Panelen weer monteren; let erop, dat de kabelboom en andere delen correct en netjes gepositioneerd worden.

- N**
- Nødvendig med montering fra fagverksted.
 - Klem jordkabelen av batteriet.
 - For å unngå skader på kabelisoleringen må berøring av skarpe kanter unngås.
 - Monter alle deler i henhold til illustrasjonene.
 - Tilkoplet batteriet igjen.
 - Monter panelene igjen, og pass på at kabelbunten og andre deler er anbrakt ordentlig og på riktig sted.

- FIN**
- Asennus tarpeen merkkikorjaamossa.
 - Erota maadoitusjohto akusta
 - Pidä huoli myös siitä, että kaapelointi on korin kiinnityksen myötäinen ja kiinnitetty huolellisesti muihin liikkuviin osiin.
 - Asenna osat kuvien mukaan.
 - Kytke akku takaisin.
 - Aseta paneelit paikalleen; tarkista, että kaapelointi ja muut osat ovat asianmukaisesti ja tarkalleen paikoillaan.

- D**
- Montage durch Fachwerkstatt erforderlich.
 - Massekabel von Batterie abklemmen.
 - Zur Vermeidung von Beschädigungen an der Kabelisolation ist Berührung mit scharfen Kanten zu vermeiden.
 - Teile gemäß Abbildung montieren.
 - Batterie wieder anschließen.
 - Paneele wieder anbringen; achten Sie darauf, daß der Kabelbaum und andere Teile ordnungsgemäß und genau positioniert sind.

- F**
- Montage par spécialiste nécessaire.
 - Débrancher le câble de masse de la batterie.
 - Eviter tout contact avec des arêtes vives afin de ne pas endommager l'isolation des câbles.
 - Monter les pièces selon les figures.
 - Reconnecter la batterie.
 - Remettre le panneau; veillez à ce que le faisceau et les autres pièces soient positionnés correctement et avec la précision requise.

- P**
- Especialista em montagem requerido.
 - Separe o cabo de terra do acumulador.
 - Para não se danificar a isolação dos cabos, é conveniente evitar-se contacto com arestas afiadas.
 - Monte as partes conforme ilustrado.
 - Recolocar a bateria
 - Tornar a colocar os painéis; verificar se a árvore de cabos e outras peças estão na posição exacta e prescrita.

- DK**
- Montage ved professionelt værksted påkrævet.
 - Stelkabel fjernes fra batteri.
 - Berøring med skarpe kanter skal undgås for at undgå beskadigelse af kabelisoleringen.
 - Dele skal monteres i henhold til illustrationer.
 - Tilslut batteri igen.
 - Paneler fastgøres igen; vær opmærksom på, at kabelsamlingen og andre dele placeres korrekt og præcist.

- S**
- Verkstadsmontage erfordras.
 - Lossa stomkabeln från batteriet.
 - För att förhindra skador på ledningarnas isolation skall beröring med vassa kanter undvikas.
 - Montera detaljerna enligt figurerna
 - Anslut batteriet igen.
 - Sätt tillbaka panelerna igen; kontrollera noga att ledningsmattan och andra detaljer ligger på rätt plats.

- CZ**
- Montáž ve specializované dílně nutná.
 - Odpojte zemnicí kabel od baterie.
 - Zabraňte tomu, aby se kabely poškodily tím, že jsou položeny na ostrých hranách.
 - Montujte části podle vyobrazení
 - Opět připojte baterii.
 - Opět připevněte panely; dbejte na to, aby svazek kabelů a ostatní části byly uloženy na správném místě.

H

- A szereléshez szakműhely kell.
- Húzza le az akkumulátor testkábeljét.
- A kábelszigetelés megsérülésének elkerülésére ügyeljen arra, hogy a kábel ne juthasson érintkezésbe éles peremű alkatrészekkel.
- Az alkatrészeket az ábrák szerint szerelje be.
- Ismét csatlakoztassa az akkumulátort.
- Szerelje vissza a fedőlapokat, ügyeljen arra, hogy a kábelek és a többi alkatrész pontosan a számkra kijelölt helyen maradjanak.

GR

- Να τοποθετεί από συνεργείο.
- Αποσυνδέστε το καλώδιο γείωσης από τη μπαταρία.
- Για να αποφευχθούν ζημιές στη μόνωση καλωδίων, να αποφεύγεται η επαφή των με αιχμηρές ακμές.
- Τοποθέτηση των μερών σύμφωνα με τις Εικόνες.
- Συνδέστε πάλι τη μπαταρία.
- Τοποθετήστε πάλι το κάλυμμα προσοχή, η πλεξούδα καλωδίων και άλλα μέρη να είναι τοποθετημένα ακριβώς και σύμφωνα με τους κανονισμούς.

TU

- Uzmanın takması gereklidir.
- Akü toprak kablosunu ayırın.
- Kablo demetinin hasar görmemesi için, sivri objelerle temasın engellenmesini sağlayın.
- Parçaları çizimlerde gösterildiği gibi takın.
- Aküyü tekrar bağlayın.
- Panoları tekrar takın, kablo demeti ve diğer komponentlerin tam ve sıkıca yerleşmesini sağlayın.

PL

- Konieczny montaż przez warsztat specjalistyczny.
- Odłączyć przewód masy od akumulatora.
- Dla zapobieżenia uszkodzeniu izolacji chronić przed zetknięciem z ostrymi krawędziami.
- Zamontować części zgodnie z rysunkiem.
- Ponownie podłączyć akumulator.
- Na powrót osadzić osłony; zadbać aby wiązka kablowa i inne części były właściwie i dokładnie ułożone.

RUS

- Монтаж должны выполнять специалисты в мастерской
- Отсоединить заземляющий кабель аккумулятора
- Во избежание повреждений изоляции кабеля не допускать соприкосновения с острыми углами
- Монтировать части согласно иллюстрации
- Снова подключить аккумулятор
- Установить панель, проверить правильность и точность расположения кабелей и других частей

TOYOTA COLOR TABLE









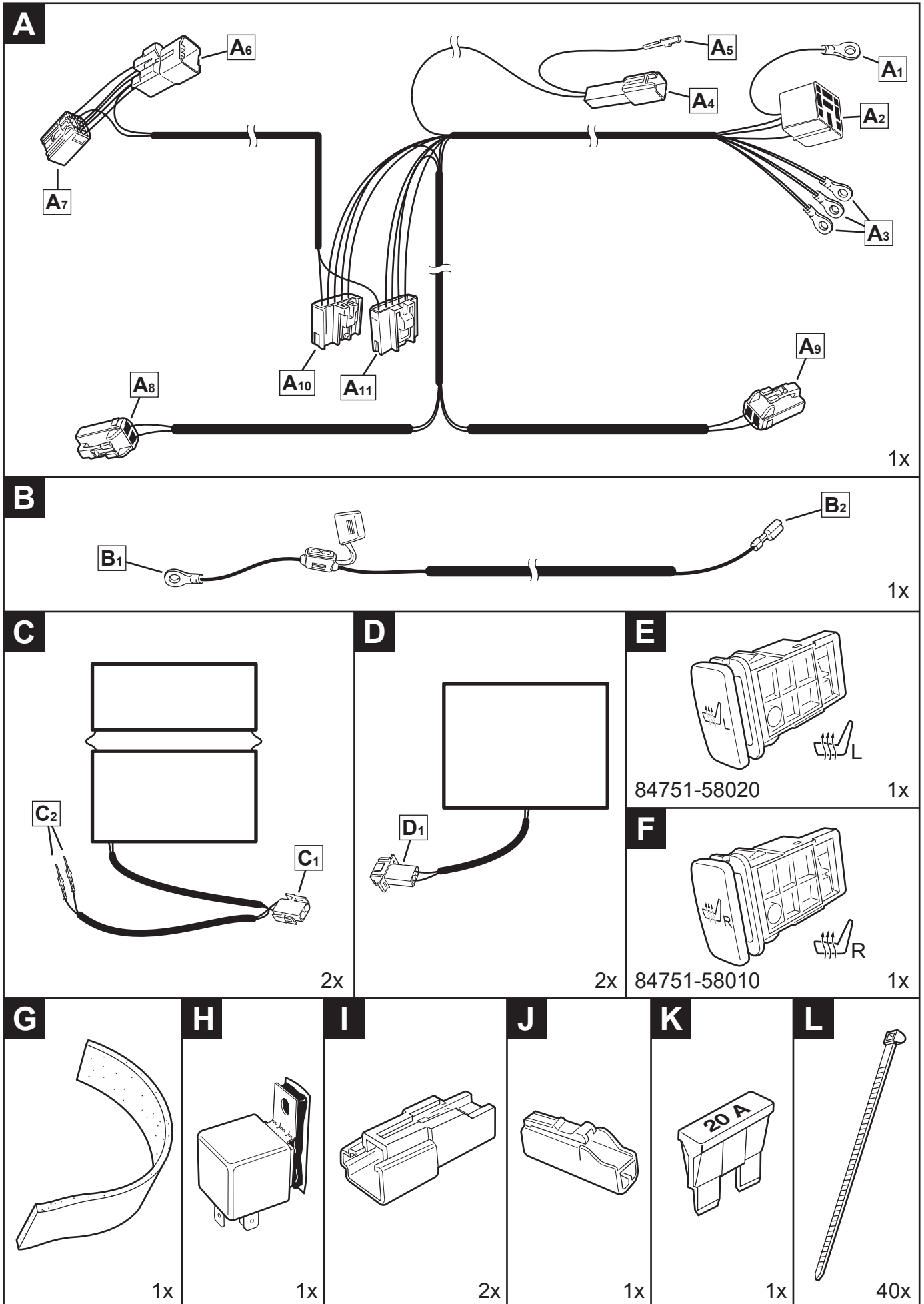

	GB	D	E	F	I	P	NL	DK
L	Blue	Blau	Azul	Bleu	Blu	Azul	Blauw	Blå
B	Black	Schwarz	Negro	Noir	Nero	Preto	Zwart	Sort
BR	Brown	Braun	Marrón	Marron	Marrone	Castanho	Bruin	Brun
DL	Dark blue	Dunkelblau	Azul oscuro	Bleu foncé	Blu scuro	Azul-escuro	Donkerblauw	Mørkeblå
DG	Dark green	Dunkelgrün	Verde oscuro	Vert foncé	Verde scuro	Verde-escuro	Donkergroen	Mørkegrøn
G	Green	Grün	Verde	Vert	Verde	Verde	Groen	Grøn
GR	Grey	Grau	Gris	Gris	Grigio	Cinzeno	Grijs	Grå
LB	Light blue	Hellblau	Azul claro	Bleu clair	Blu chiaro	Azul-claro	Lichtblauw	Lyseblå
LG	Light green	Hellgrün	Verde claro	Vert clair	Verde chiaro	Verde-claro	Lichtgroen	Lysegrøn
N	Natural colour	Naturfarben	Color natural	Nature	Colori naturali	Cores naturels	Naturel	Naturfarvet
O	Orange	Orange	Naranja	Orange	Arancione	Laranja	Oranje	Orange
P	Pink	Rosa	Rosa	Rose	Rosa	Rosa	Rosé	Rosa
R	Red	Rot	Rojo	Rouge	Rosso	Vermelho	Rood	Rød
PU	Purple	Purpur	Púrpura	Pourpre	Rosso porpora	Púrpura	Paars	Purpur
SB	Sky blue	Himmelblau	Azul cielo	Bleu ciel	Celeste	Azul-céu	Hemelsblauw	Himmelblå
T	Yellow brown	Gelbbraun	Amarillo-marrón	Marron-jaune	Giallomarrone	Castanho-amarelado	Geelbruin	Gulbrun
W	White	Weiß	Blanco	Blanc	Bianco	Branco	Wit	Hvid
Y	Yellow	Gelb	Amarillo	Jaune	Giallo	Amarelo	Geel	Gul
V	Violet	Violett	Violeta	Violet	Viola	Violeta	Violet	Violet

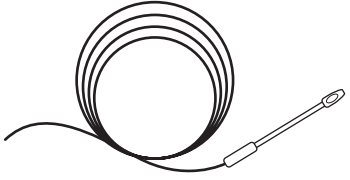
TOYOTA COLOR TABLE

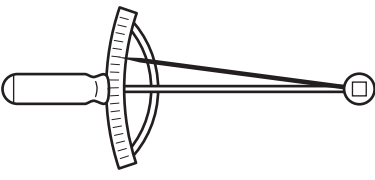
	N	S	SF	CZ	H	PL	GR
L	Blå	Blå	Sininen	Modrá	Kék	Niebieska	Μπλε
B	Sort	Svart	Musta	Černá	Feket	Czarna	Μαύρο
BR	Brun	Brun	Ruskea	Hnědá	Barna	Brazowa	Καφέ
DL	Mørkeblå	Mörkblå	Tummansininen	Tmavomodrá	Sötétké	Granatowa	Σκούρο μπλε
DG	Mørkegrønn	Mörkgrön	Tummanvihreä	Tmavozelená	Sötétzöl	Ciemnozielona	Σκούρο πράσινο
G	Grønn	Grön	Vihreä	Zelená	Zöl	Zielona	Πράσινο
GR	Grå	Grå	Harmaa	Šedá	Szürke	Szara	Γκρι
LB	Lyseblå	Ljusblå	Vaaleansininen	Bleděmodrá	Világoskék	Jasnoniebieska	Ανοιχτό μπλε
LG	Lysegrønn	Ljusgrön	Vaaleanvihreä	Světlezelená	Világoszöld	Jasnozielona	Ανοιχτό πράσινο
N	Naturfarger	Naturfärger	Luonnonväri	Přírodní	Természetes színű	Barwy	Φυσικά χρώματα
O	Orange	Orange	Oranssi	Oranžová	Narancs	Pomarańczowa	Πορτοκαλί
P	Rosa	Rosa	Rosa	Růžová	Rózsaszín	Różowa	Ροζ
R	Rød	Röd	Punainen	Červená	Piros	Czerwona	Κόκκινο
PU	Purpur	Purpur	Purppura	Purpurov	Bíborvörös	Purpurowa	Πορφυρό
SB	Himmelblå	Himmelsblå	Taivaansininen	Blankytná	Égszínkék	Bękitna	Γαλάζιο
T	Gulbrun	Gulbrun	Keltaisenruskea	Žlutohnědá	Sárgásbarna	Żółtabrazowa	Κιτρινοκαφέ
W	Hvit	Vit	Valkoinen	Bílá	Fehé	Biała	Λευκό
Y	Gul	Gul	Keltainen	Žlutá	Sárga	Żółta	Κίτρινο
V	Fiolett	Violett	Violetti	Fialová	Ibolyaké	Fioletowa	Μοβ

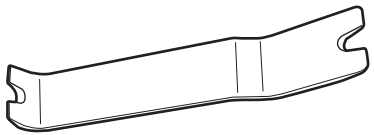
	RUS	TU				
L	Синий	Mavi				
B	Черный	Siyah				
BR	Коричневый	Kahverengi				
DL						
DG						
G	Зеленый	Yeşil				
GR	Серый	Gri				
LB						
LG						
N	Естественный цвет	Nötr				
O	Оранжевый	Turuncu				
P	Розовый	Pembe				
R	Красный	Kırmızı				
PU						
SB						
T						
W	Белый	Beyaz				
Y	Желтый	Sarı				
V	Фиолетовый	Mor				

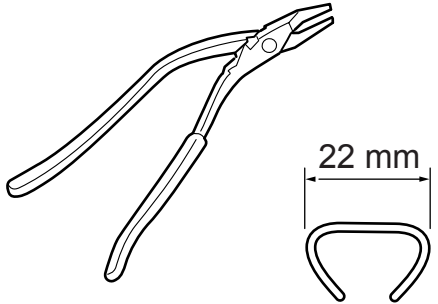
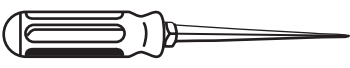
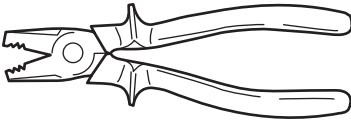
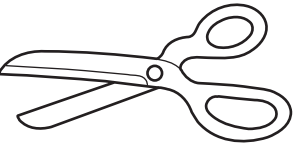
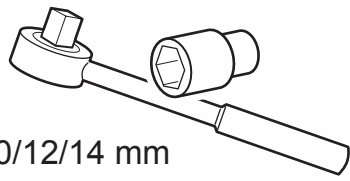
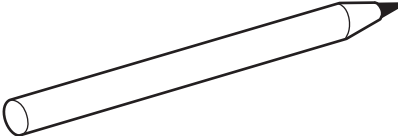
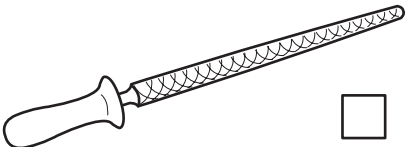
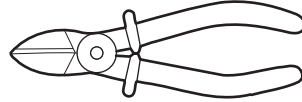
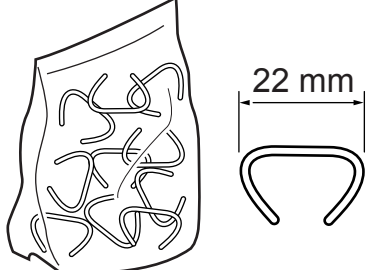

		
		
		 <p>22 mm</p>
		
 <p>10/12/14 mm</p>		
	 <p>22 mm</p>	
		

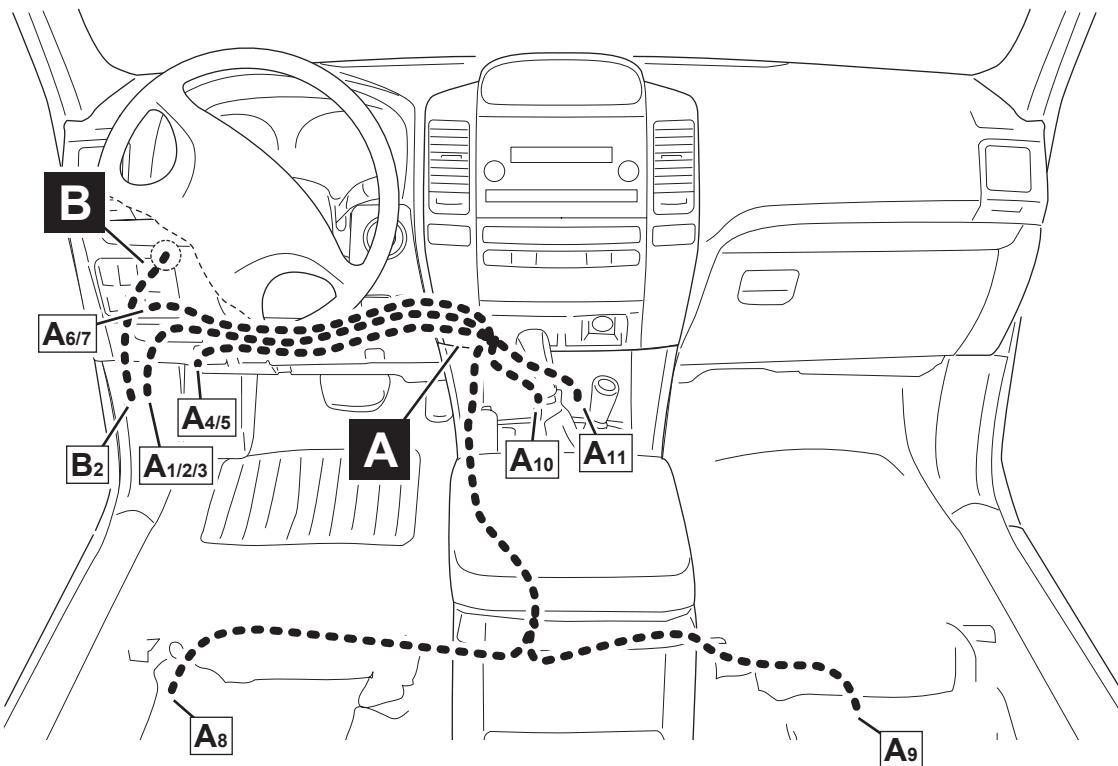
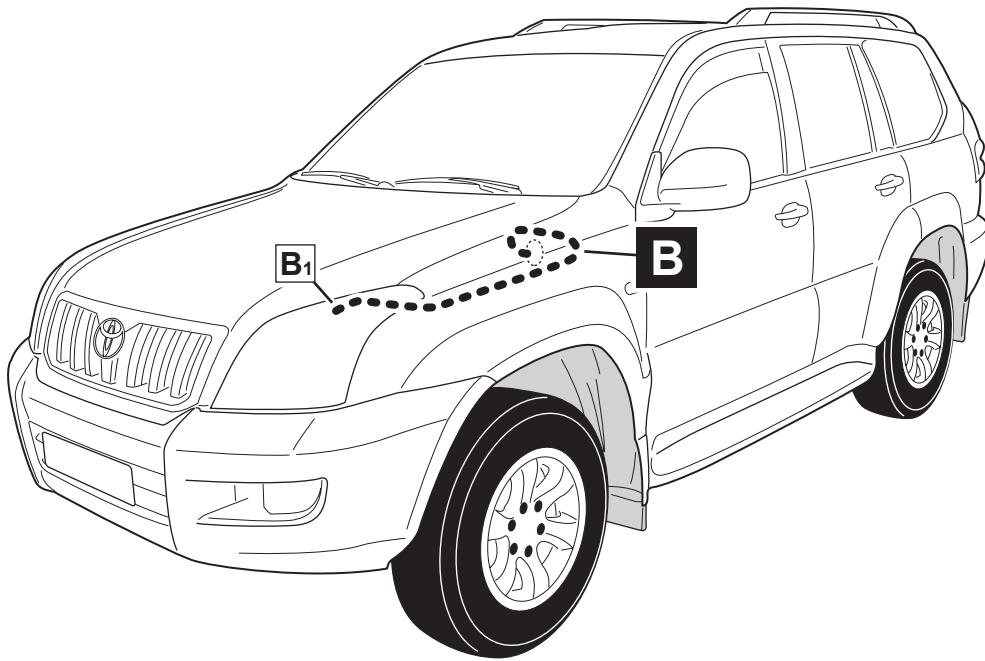

ROUTING

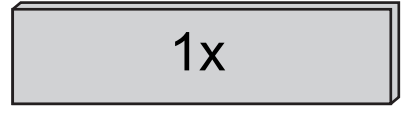
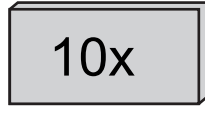
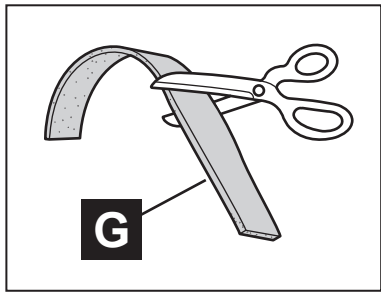

100mm

200mm

1

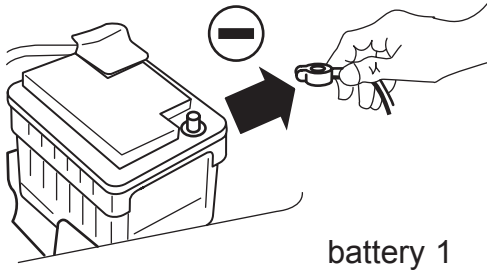

battery 1

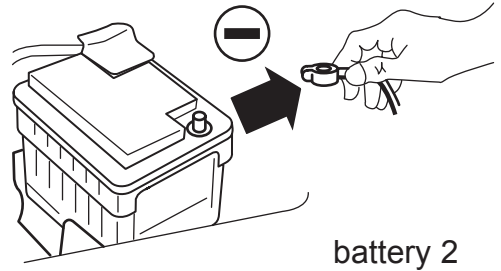

battery 2



$\geq 90''$



2

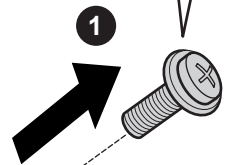
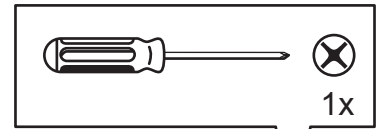
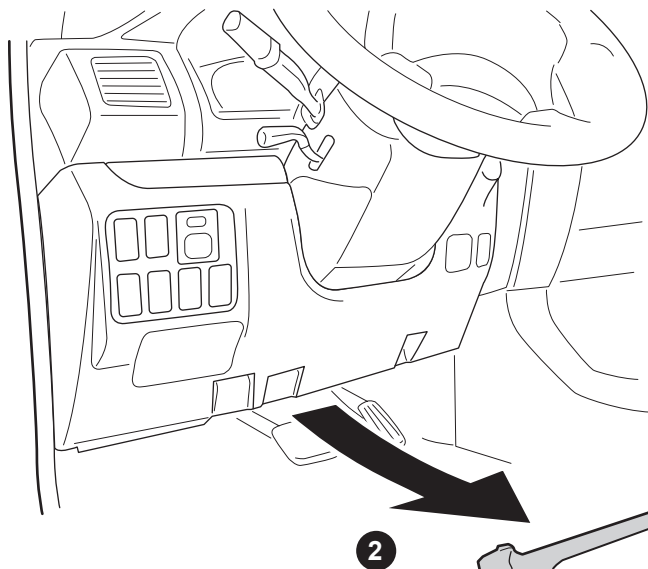

3

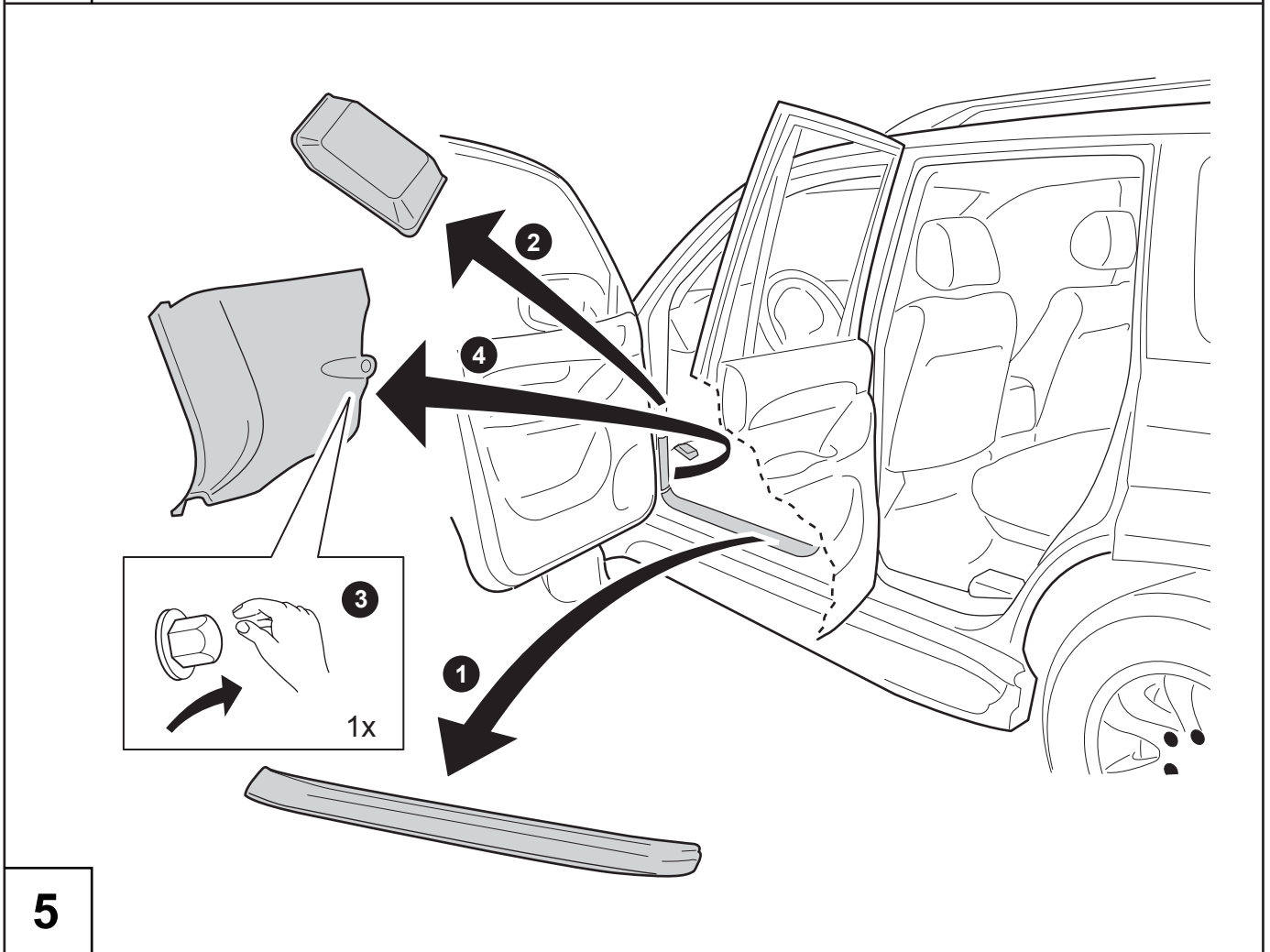
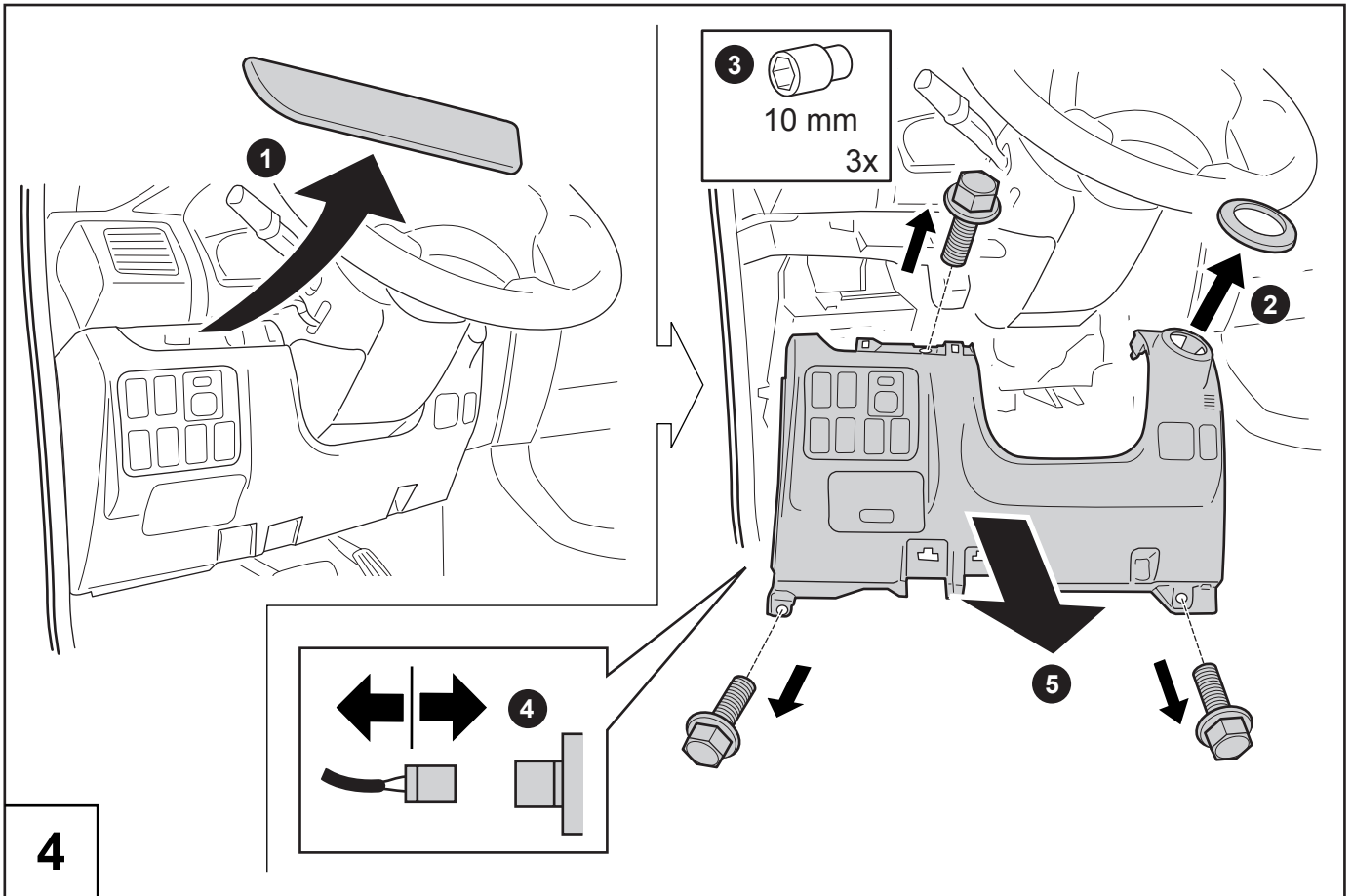

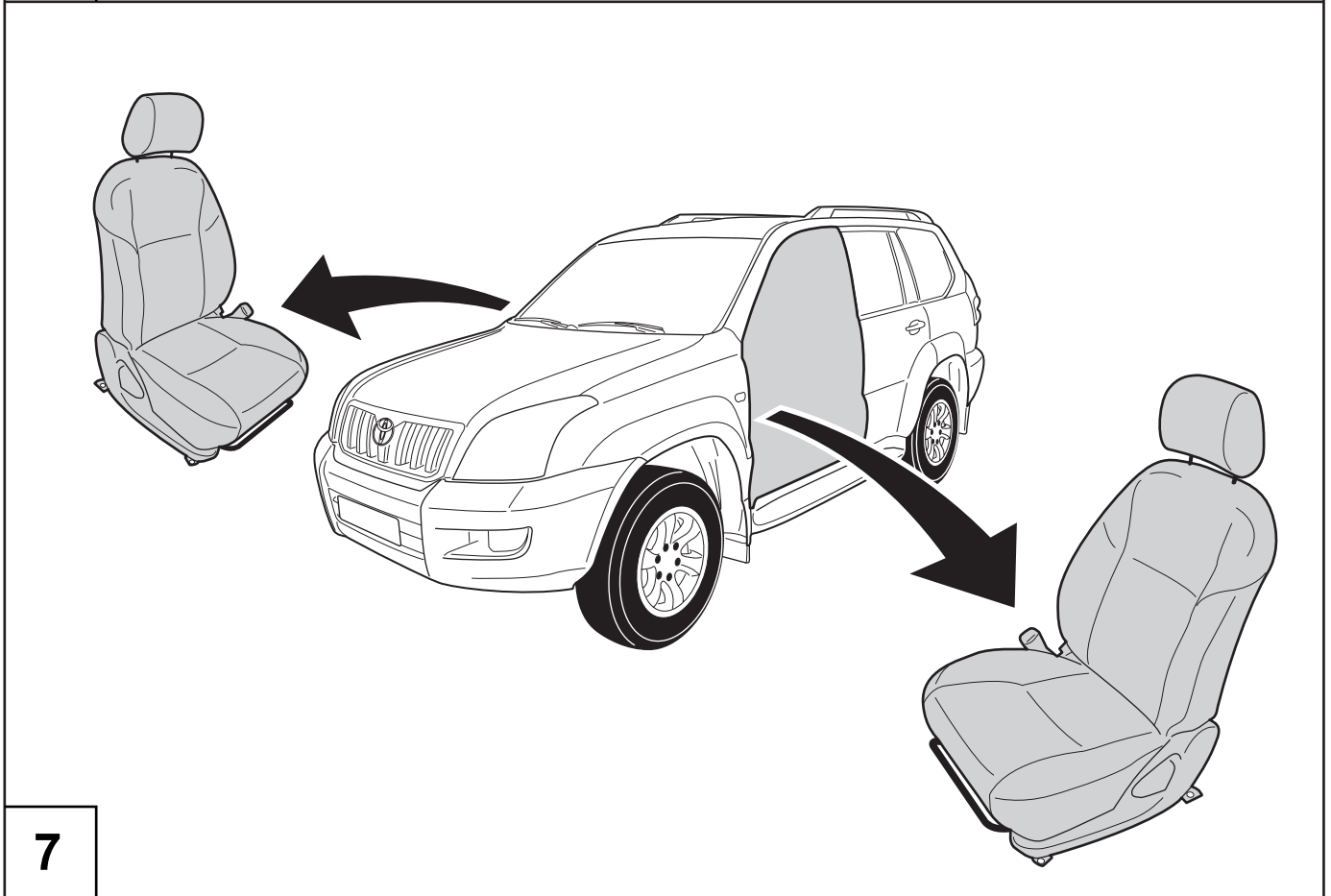
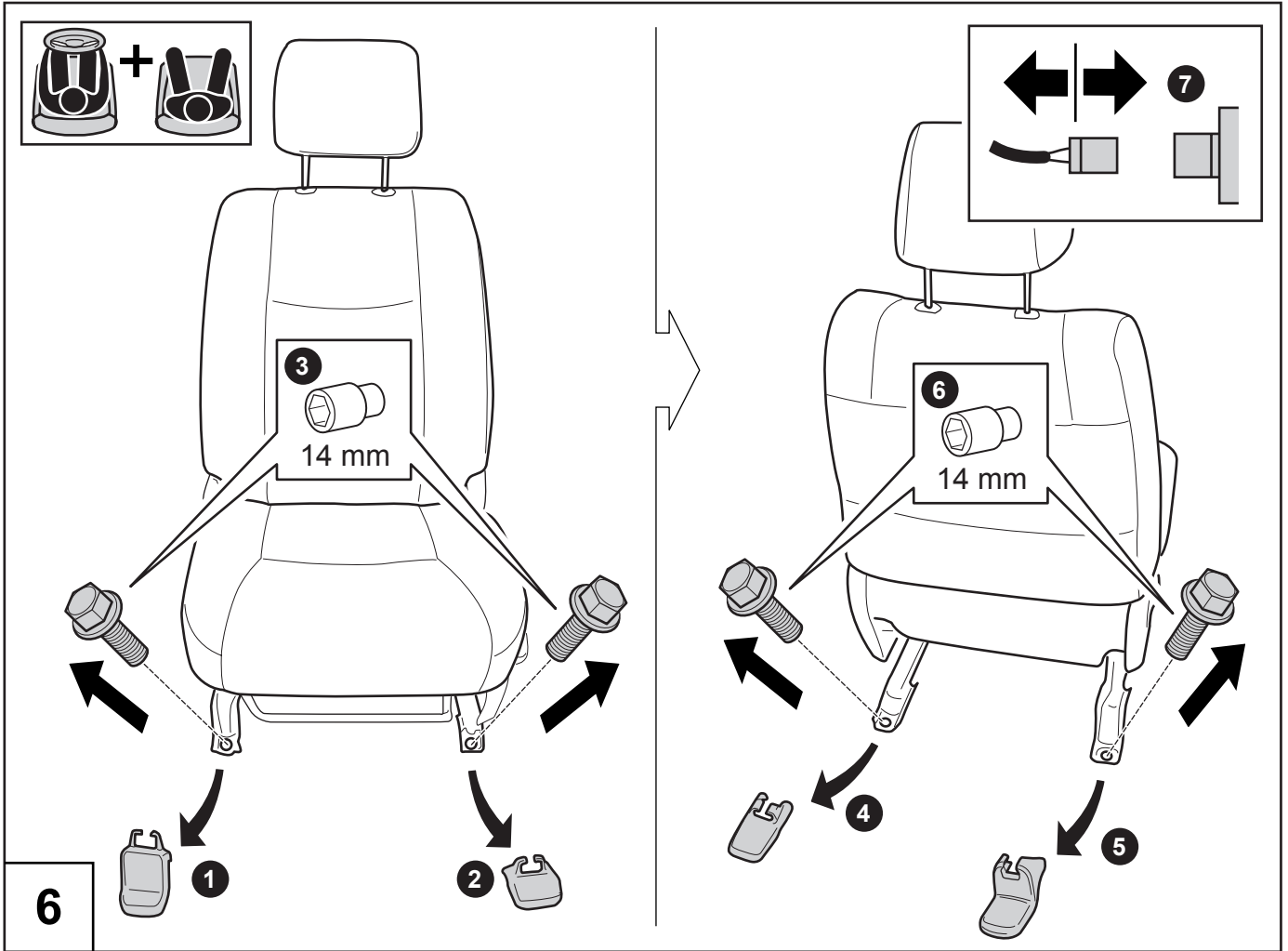

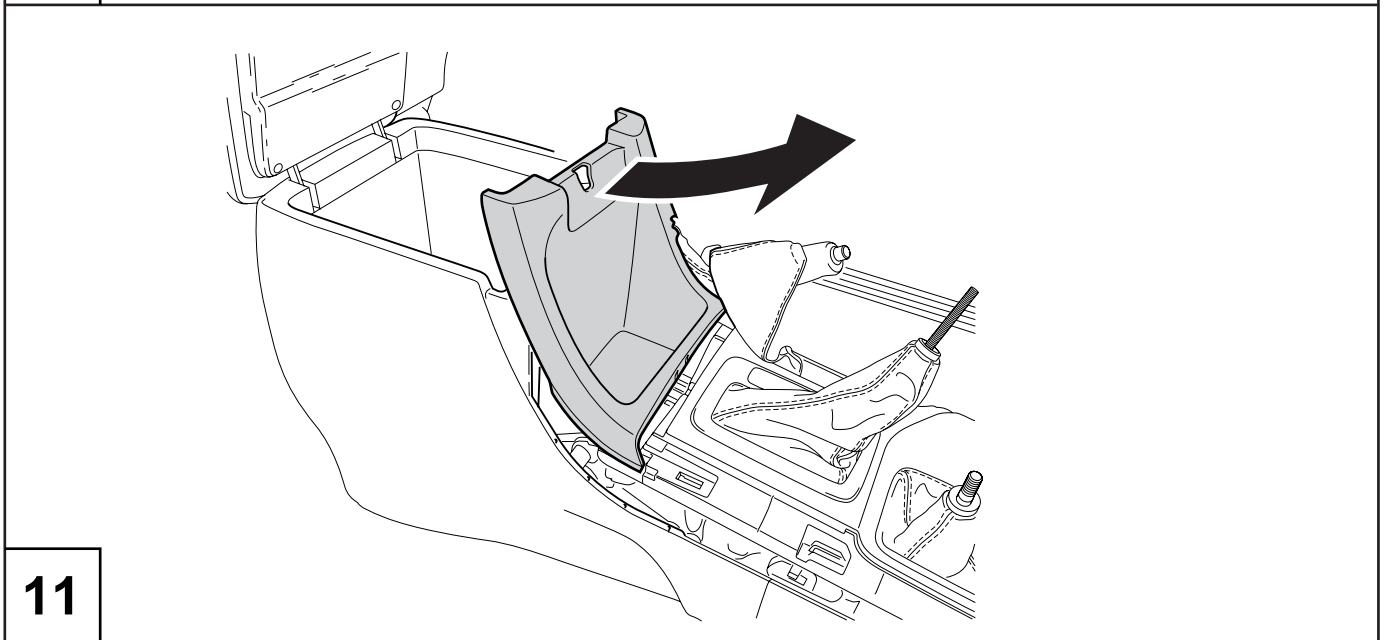
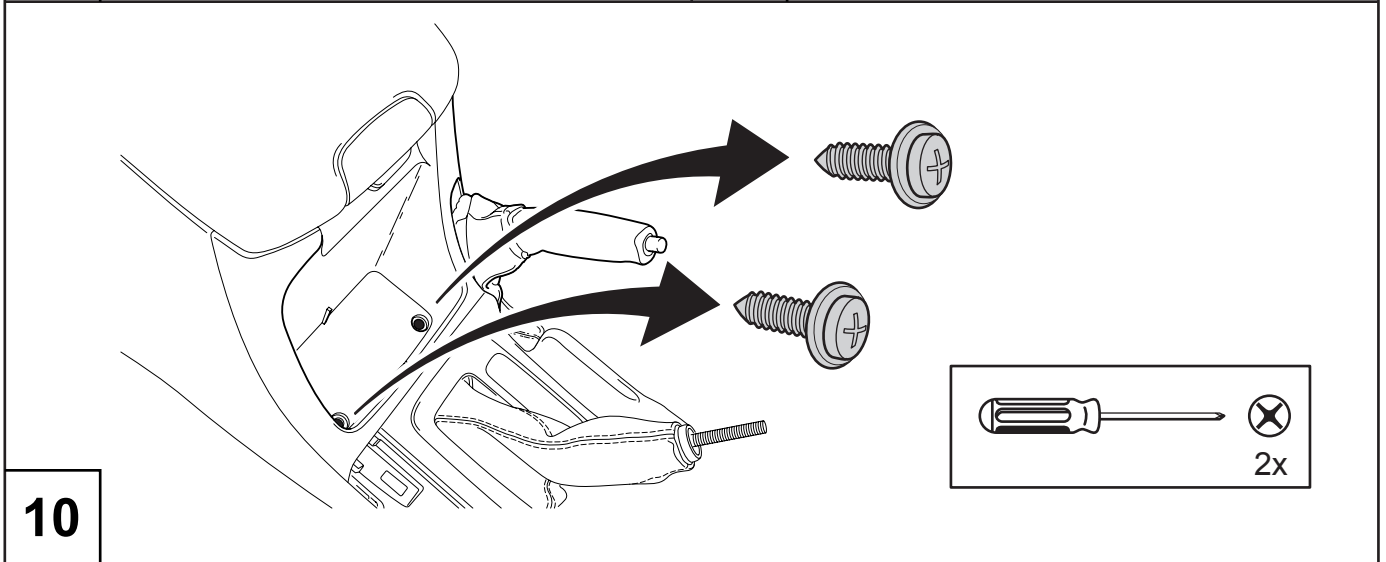
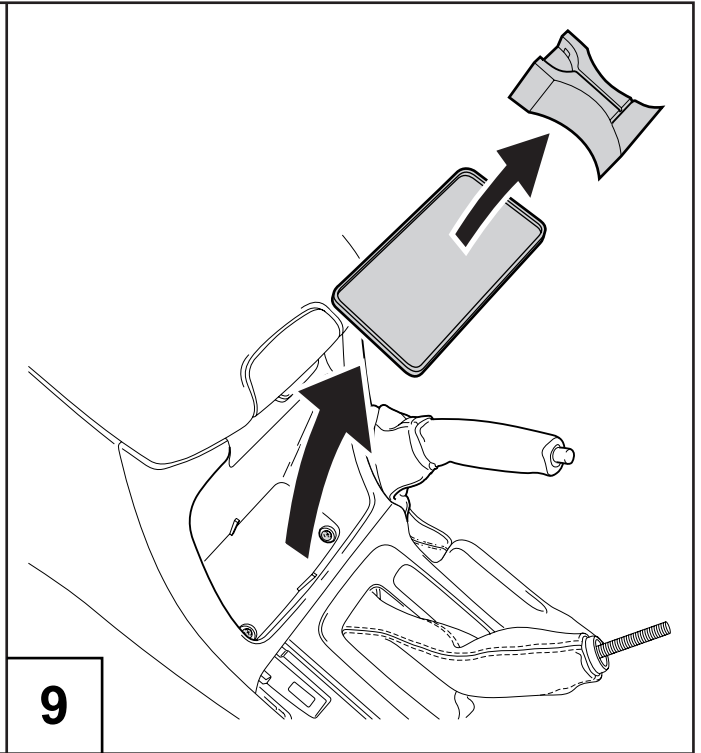
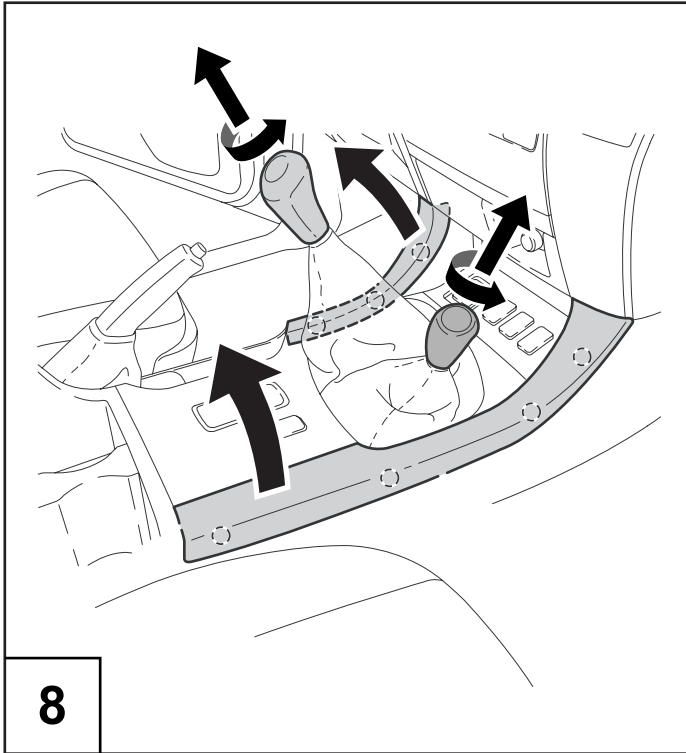

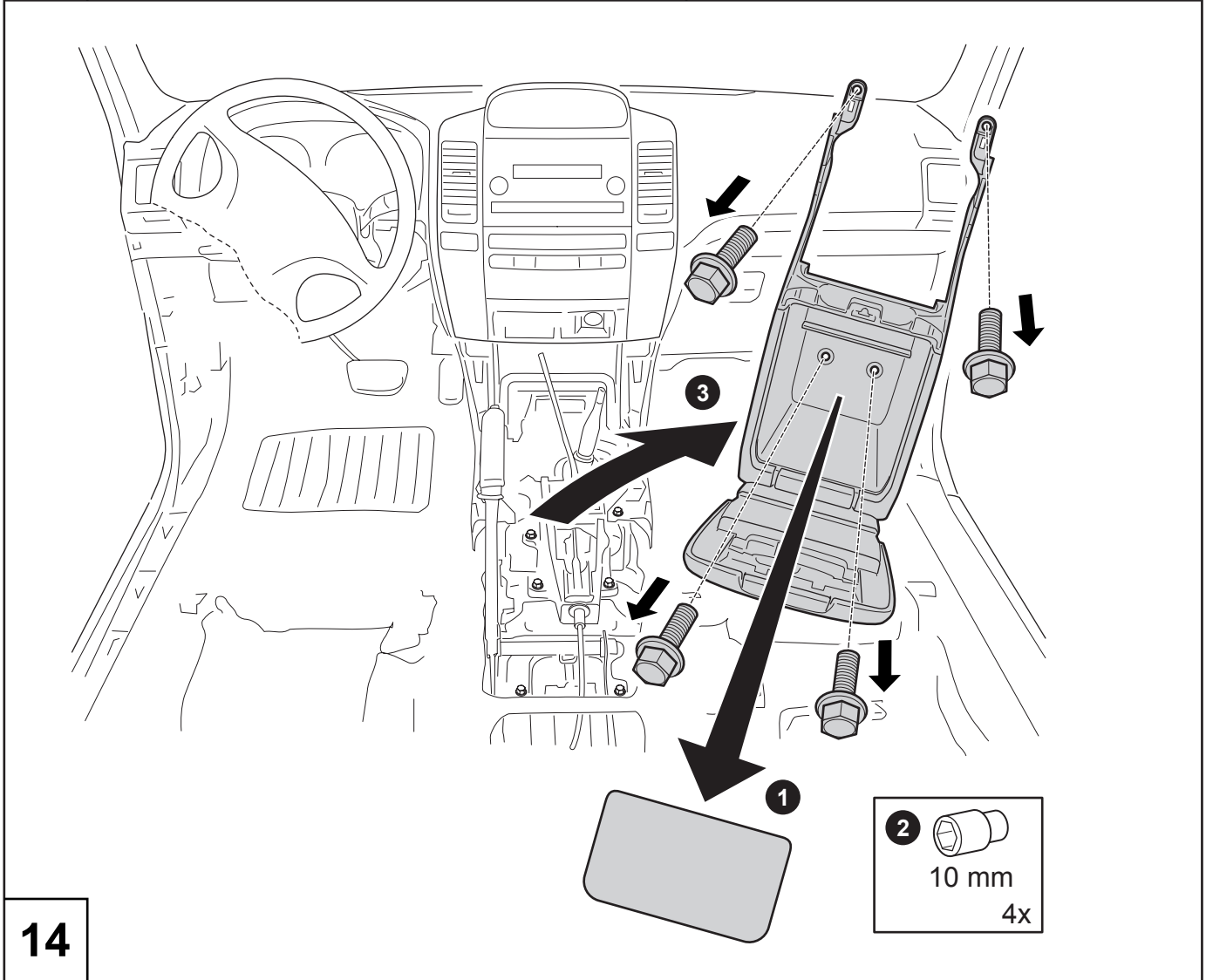
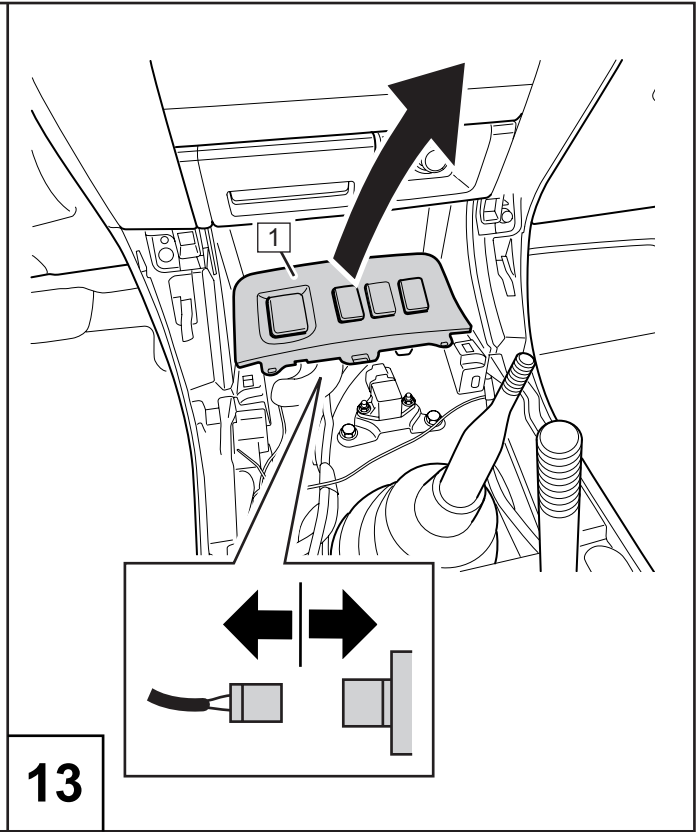
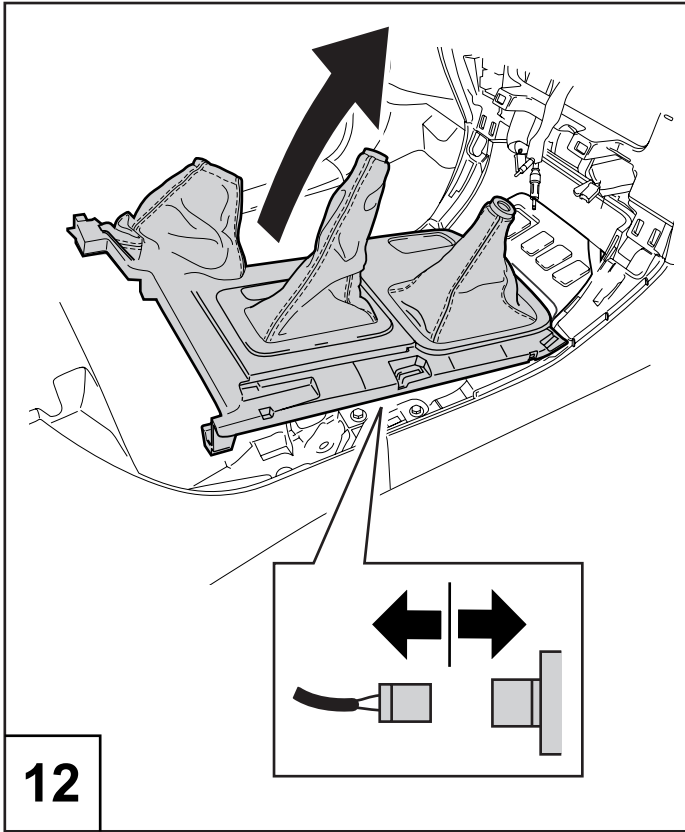

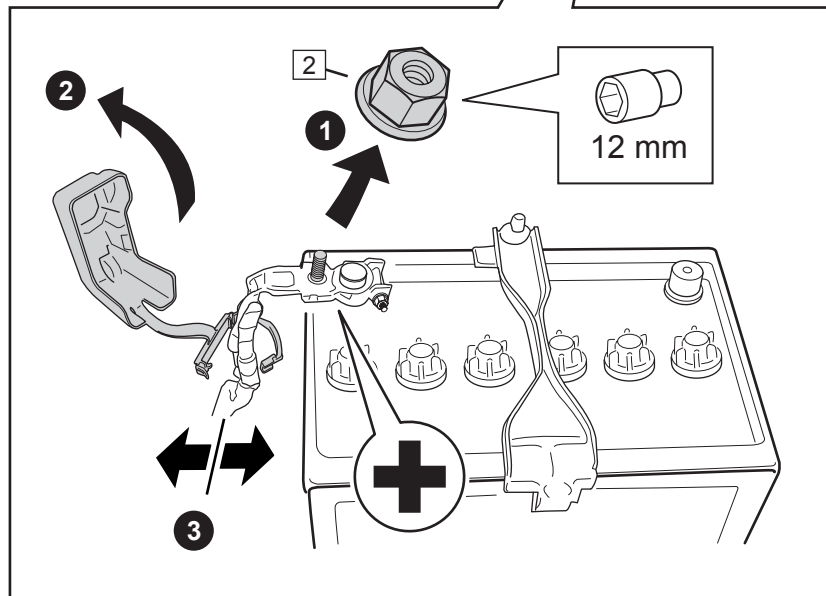
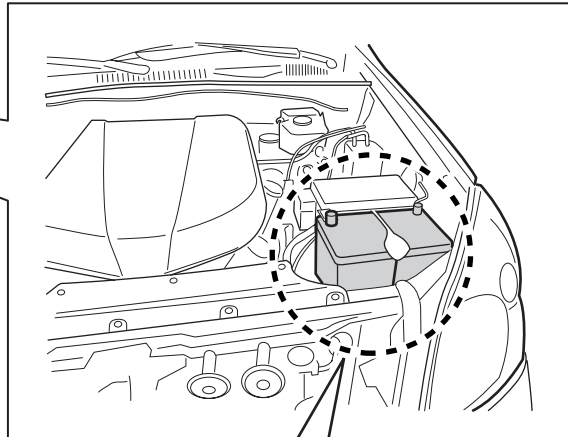
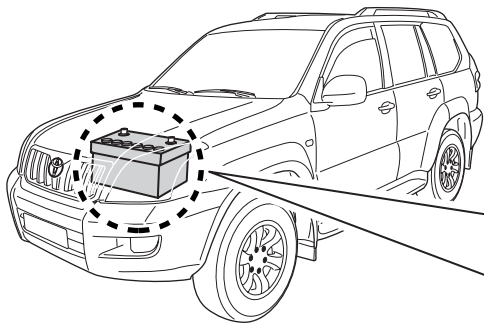

15

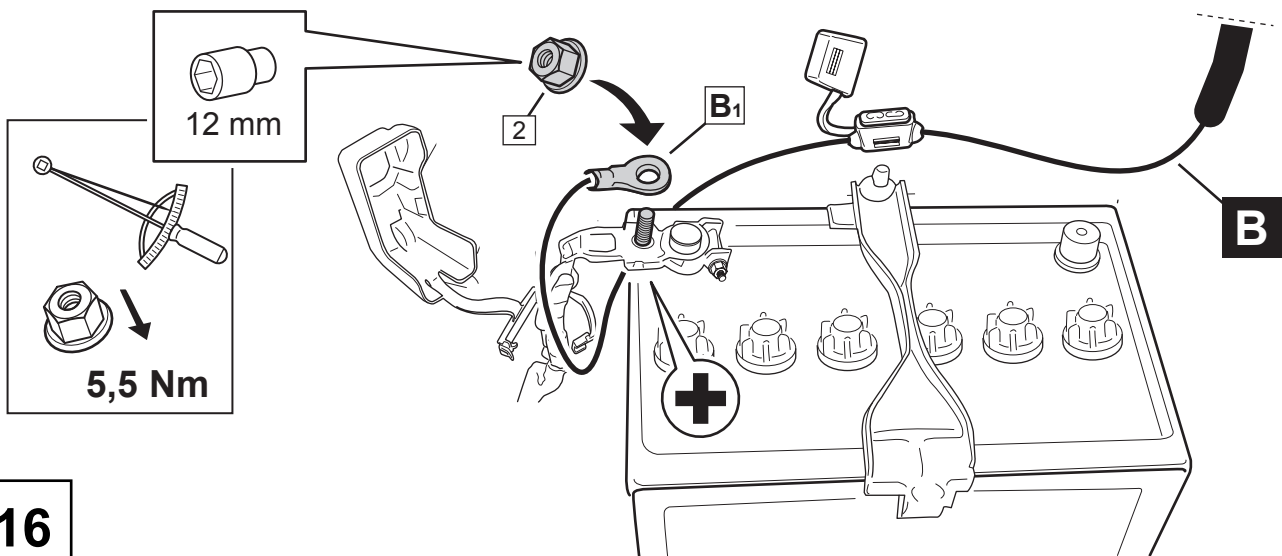

16

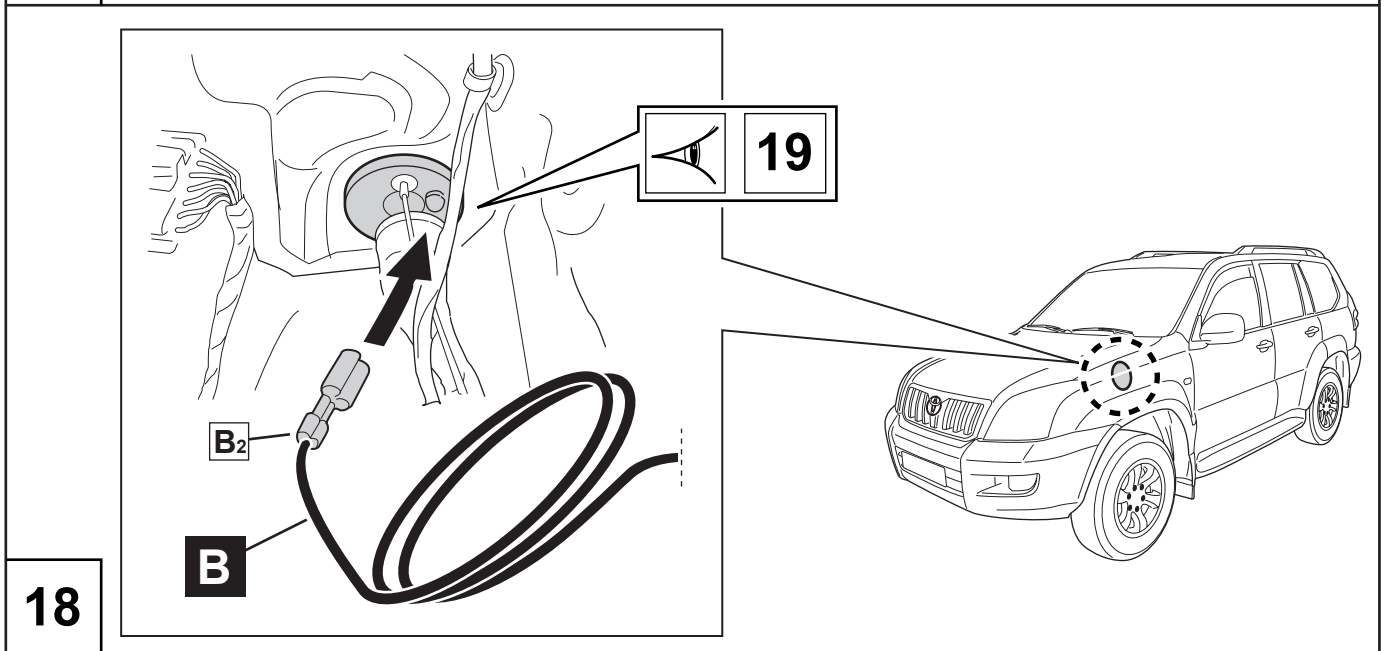
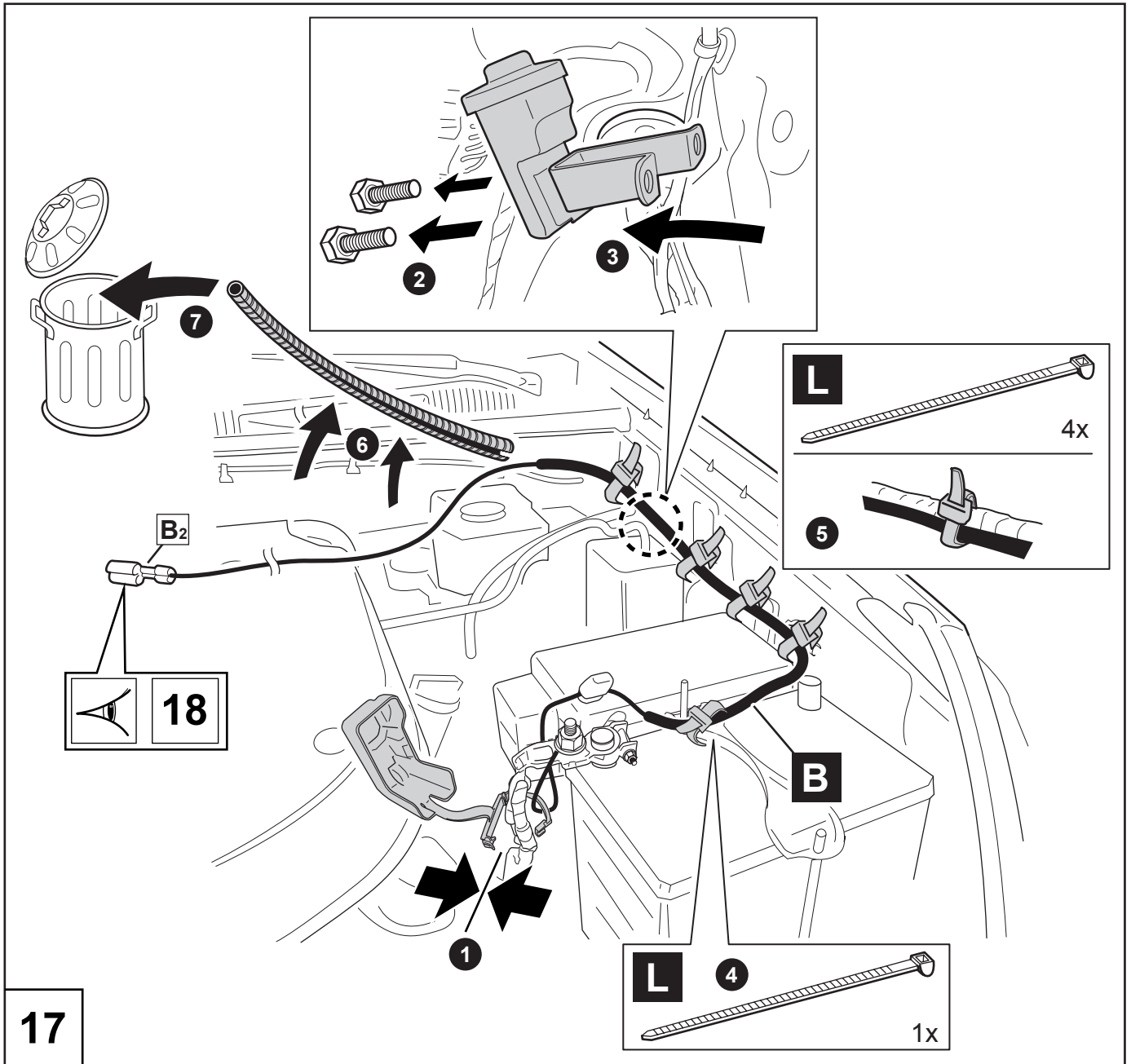

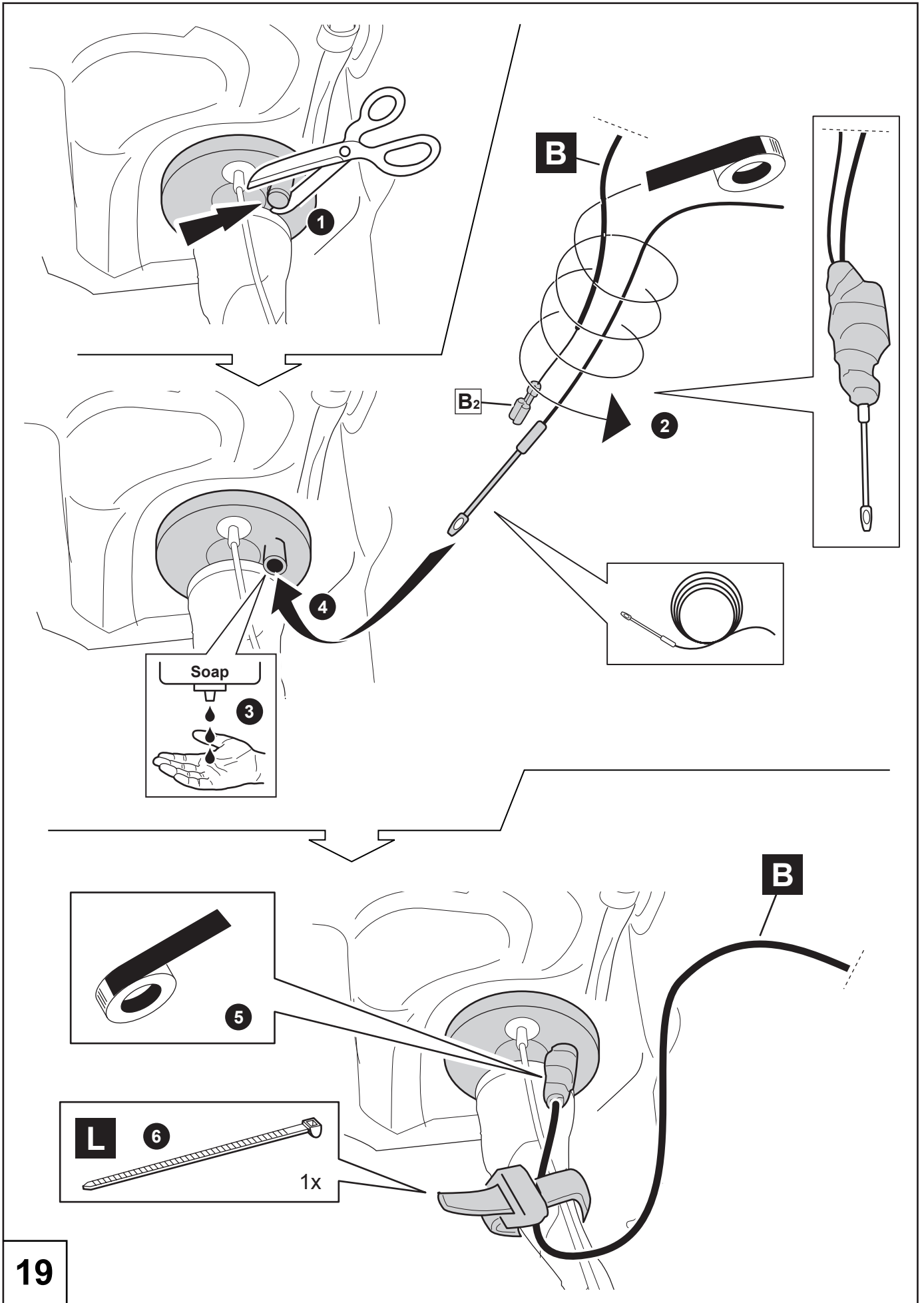

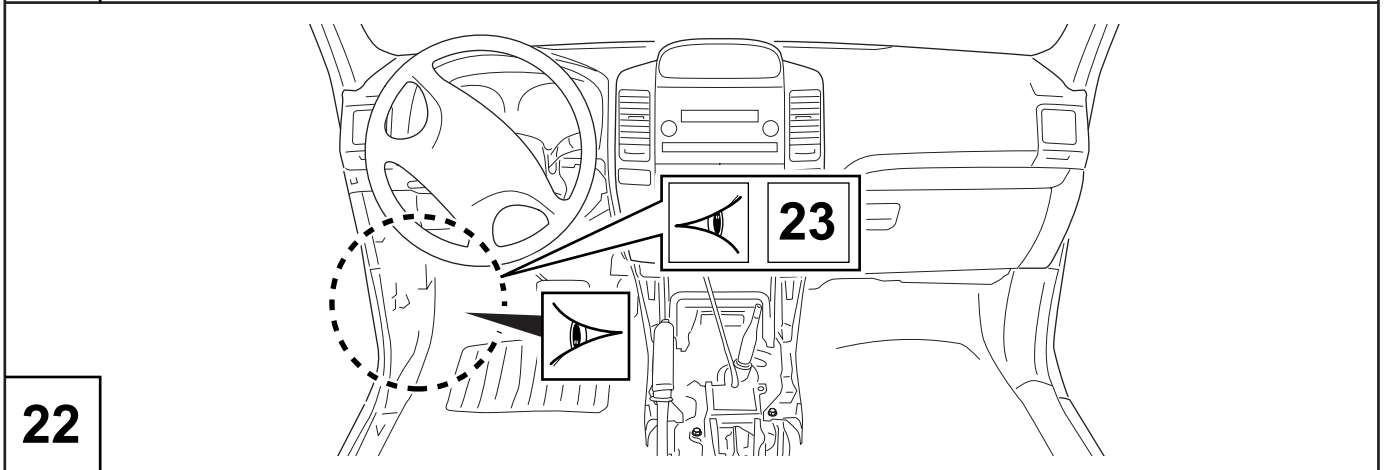
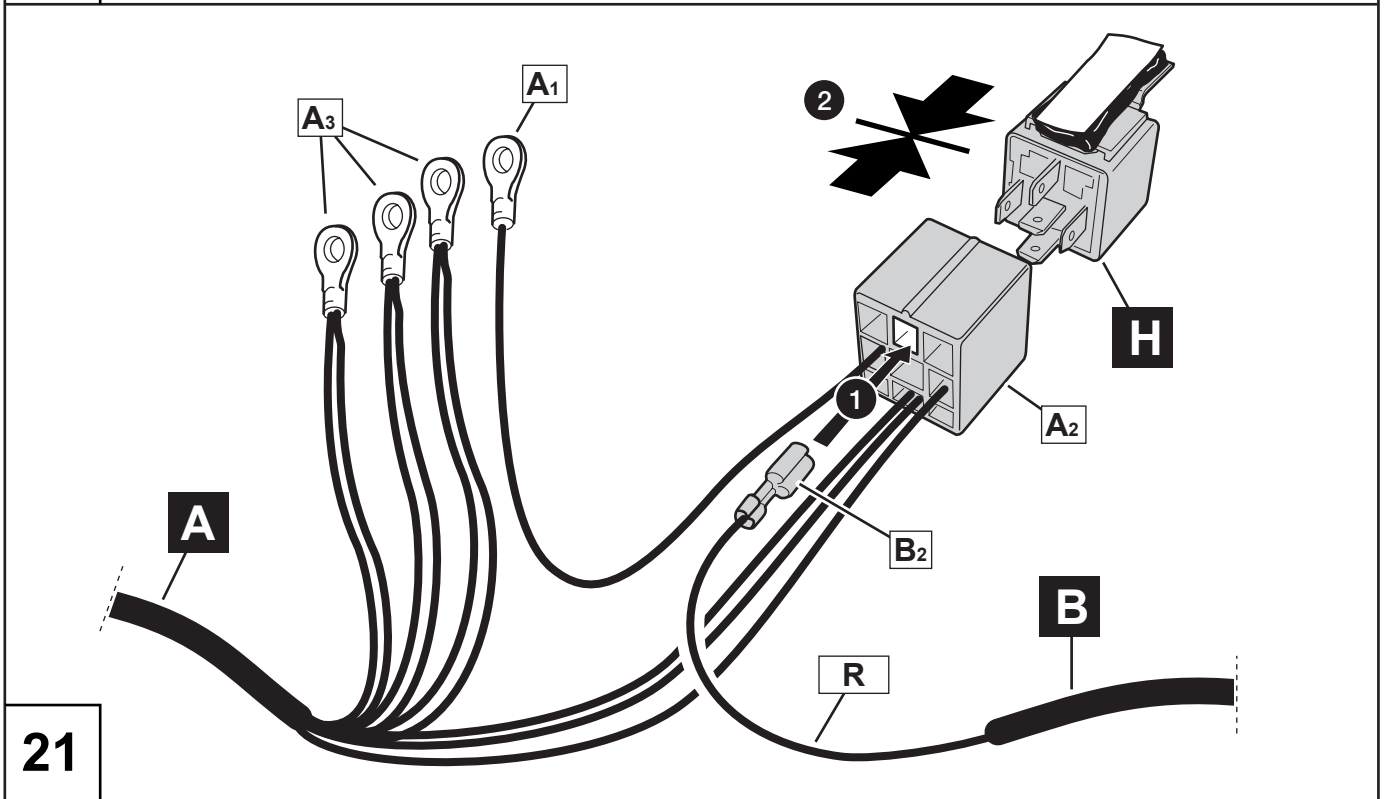
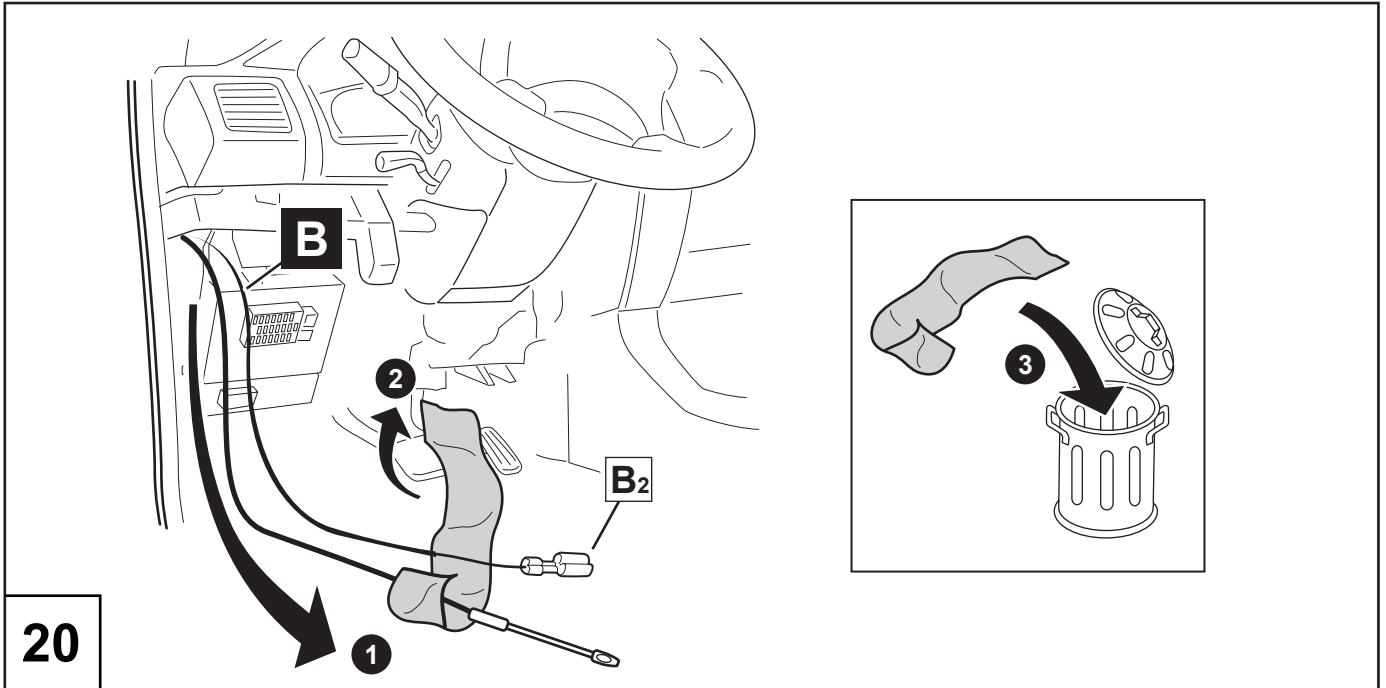

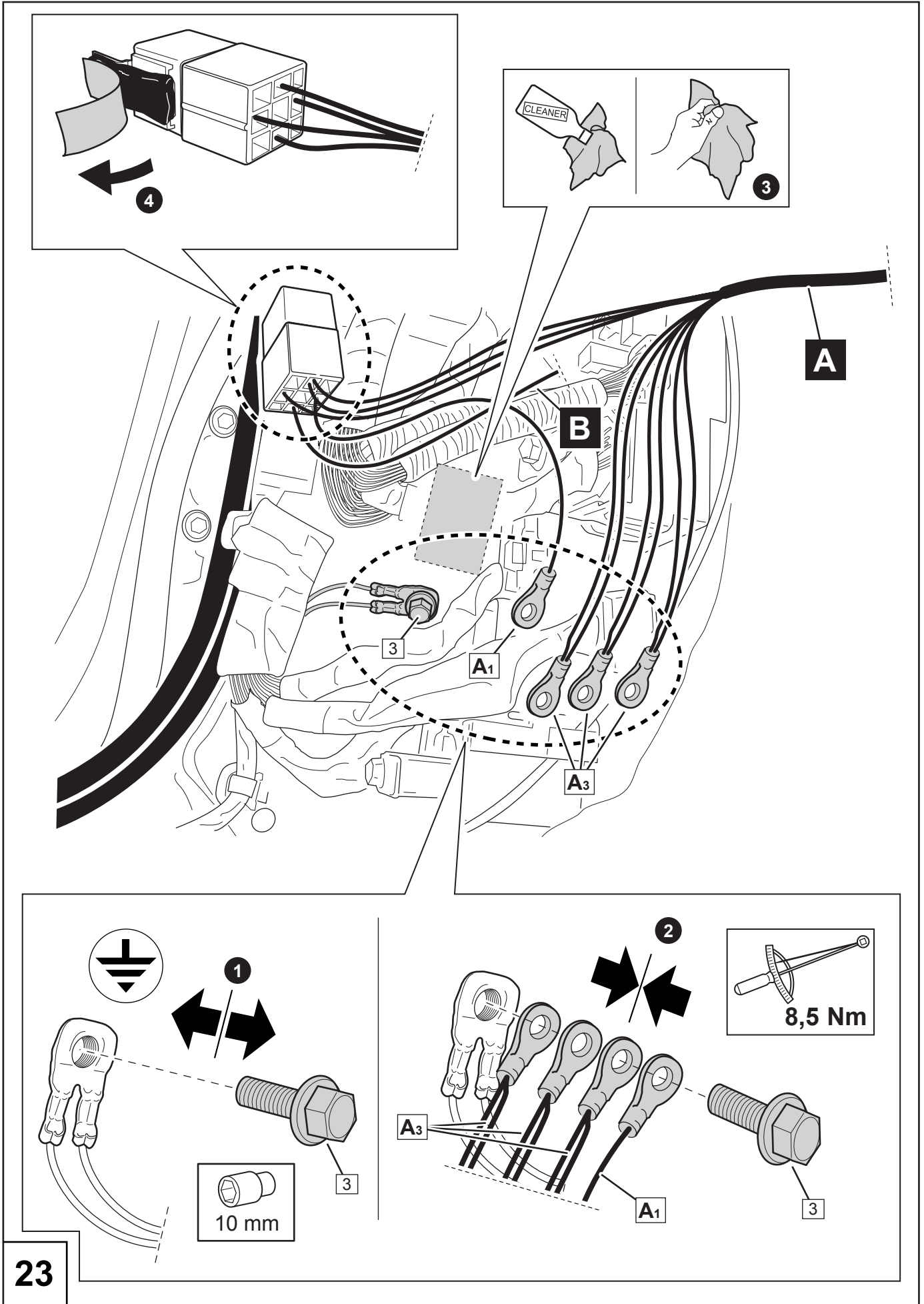

23

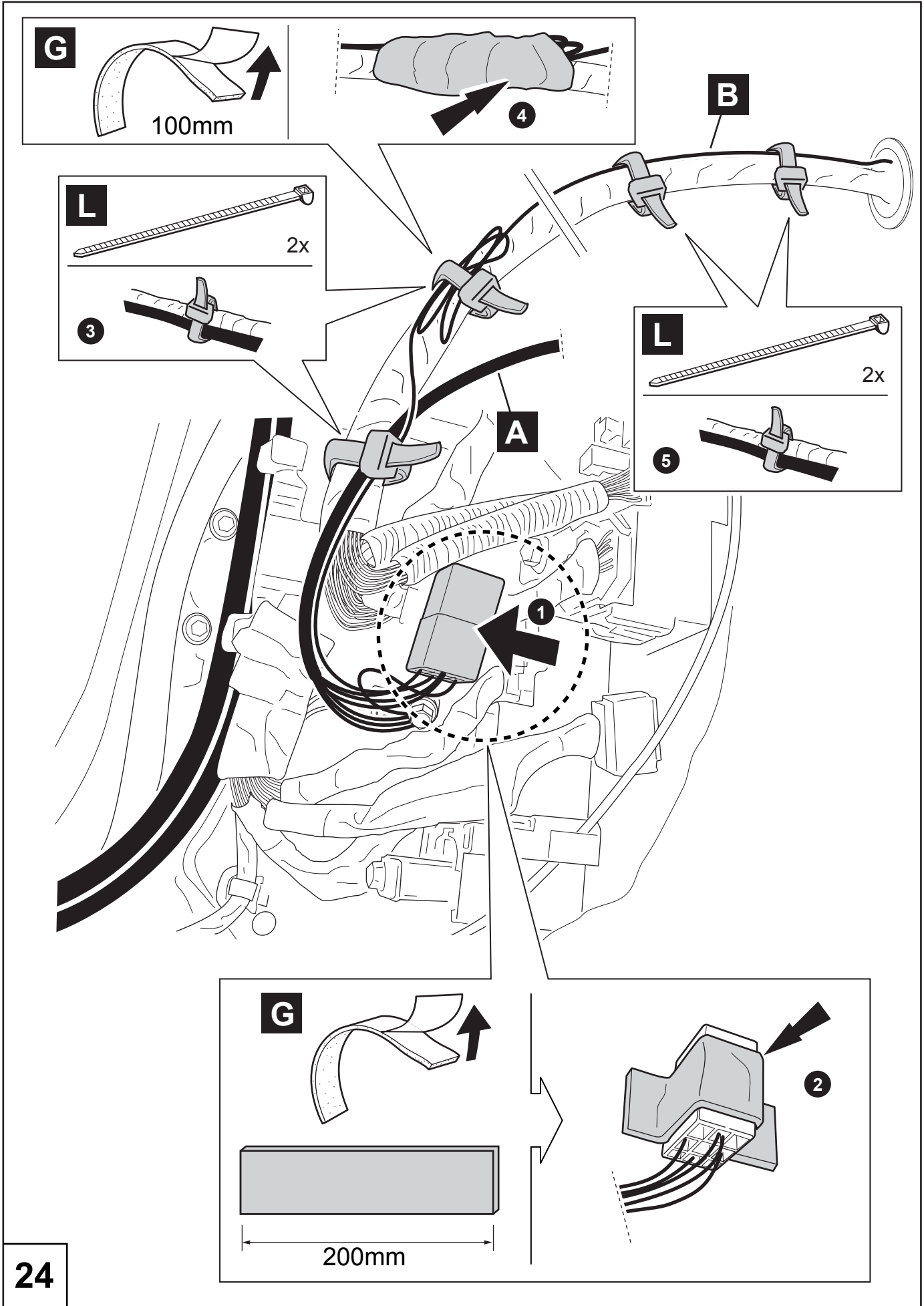

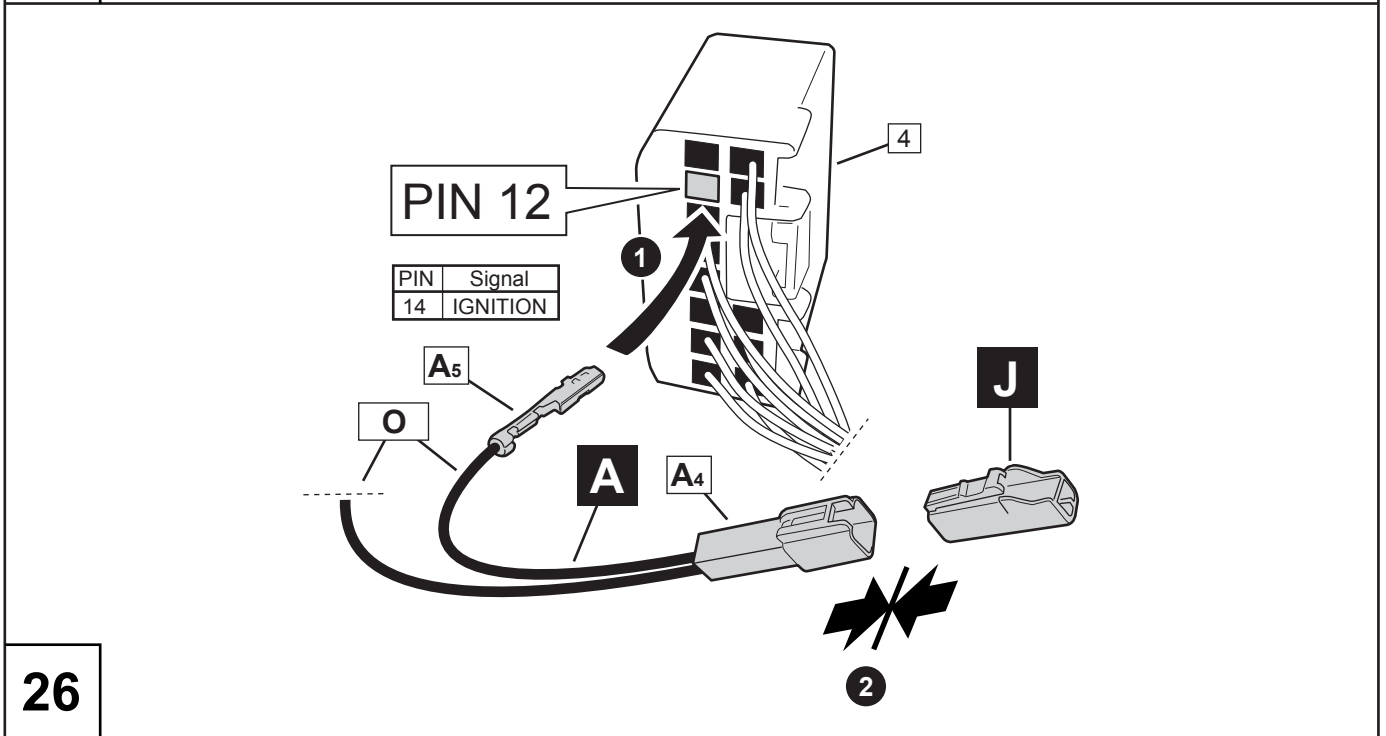
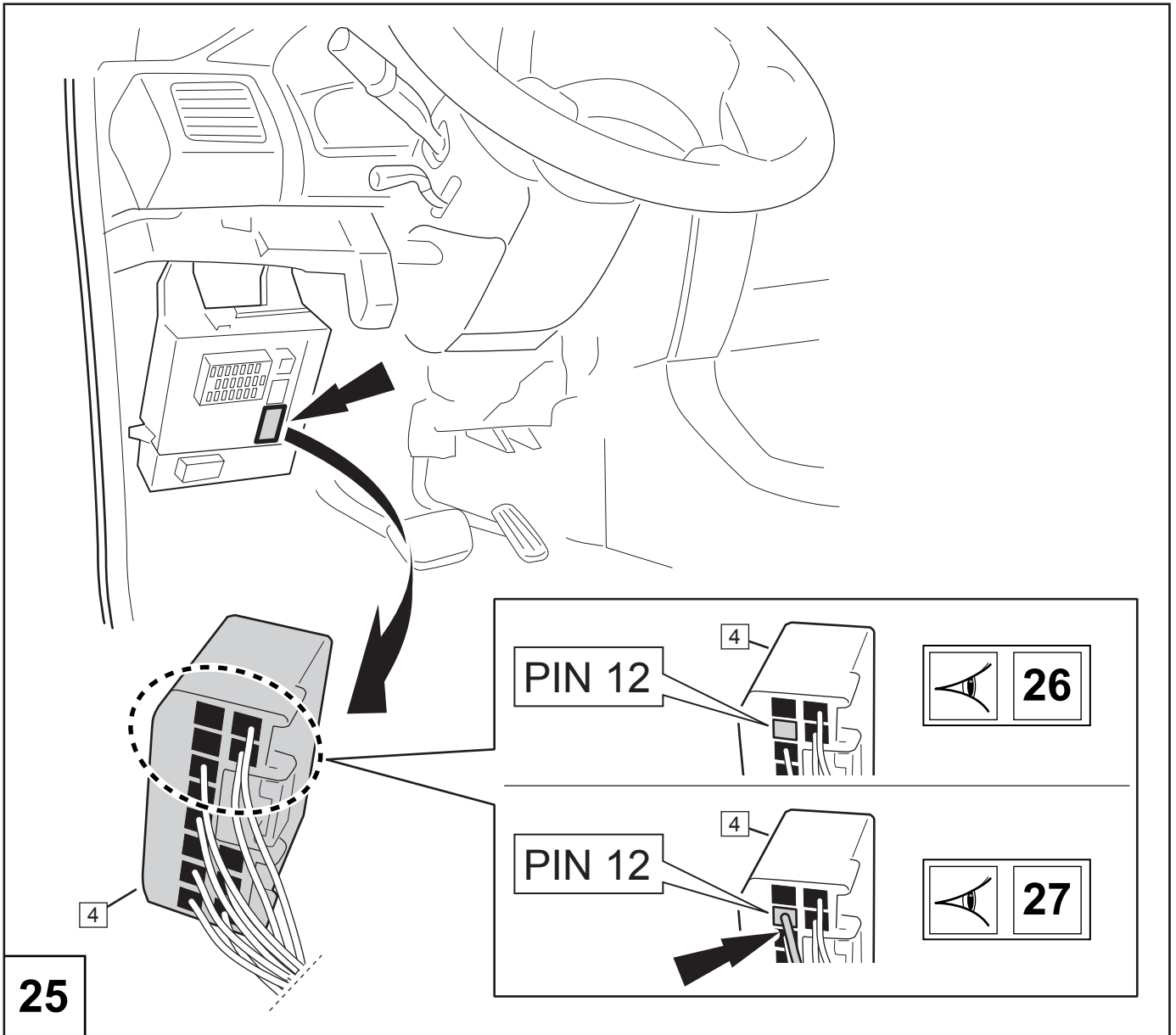

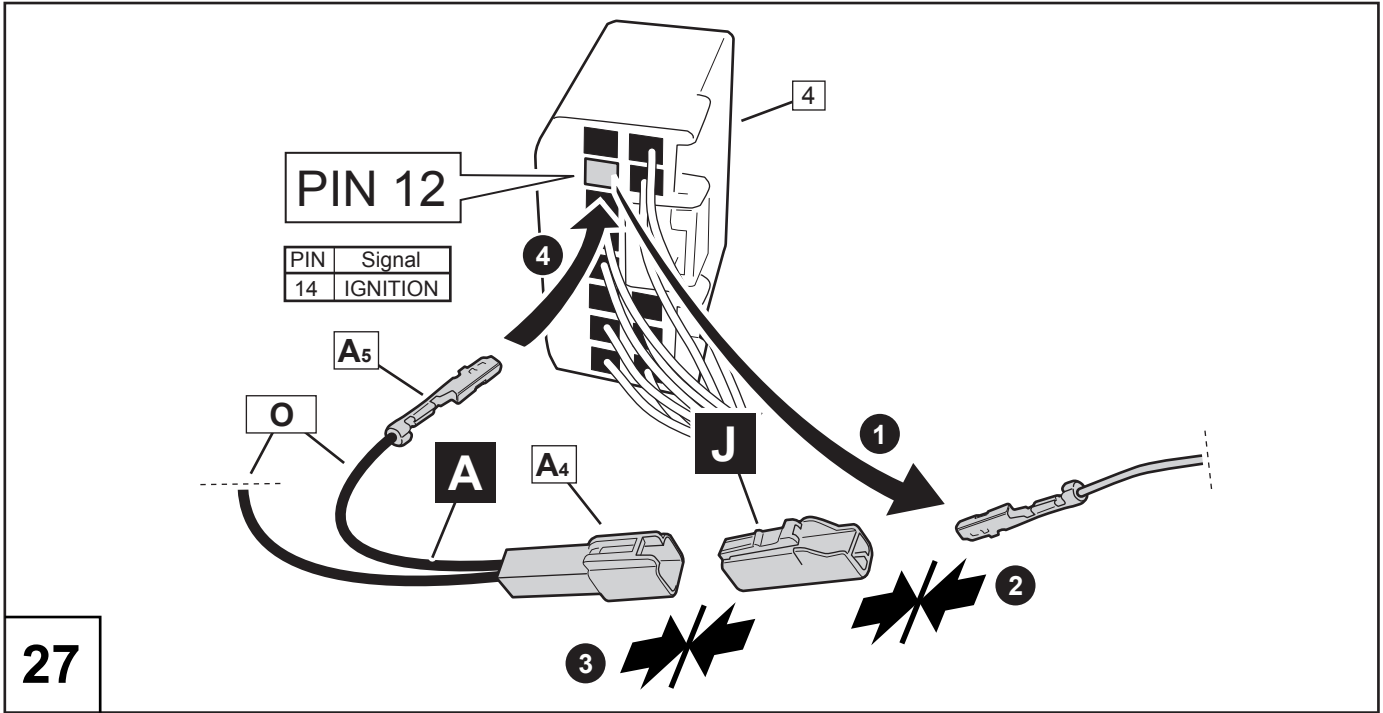

27

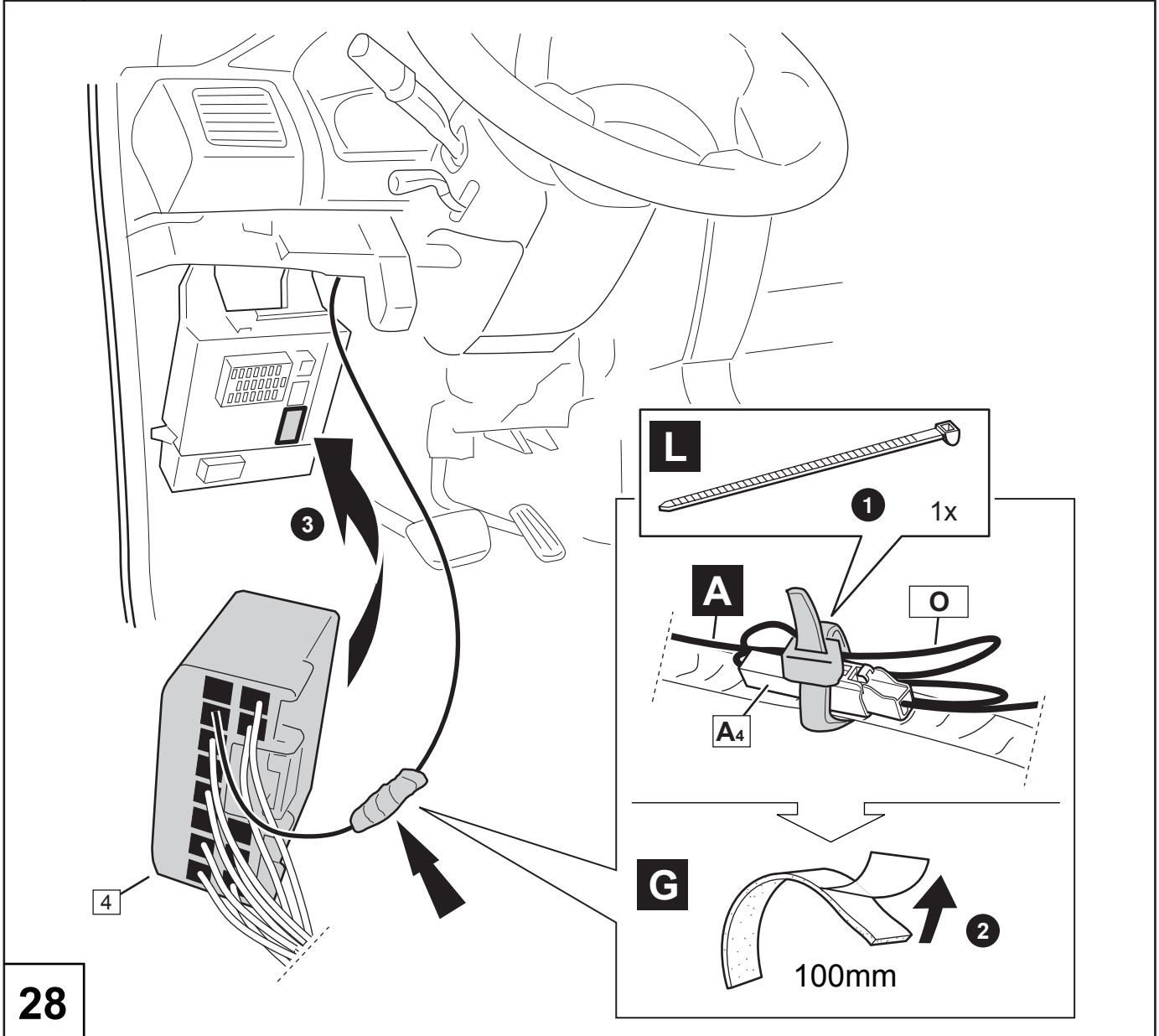

28

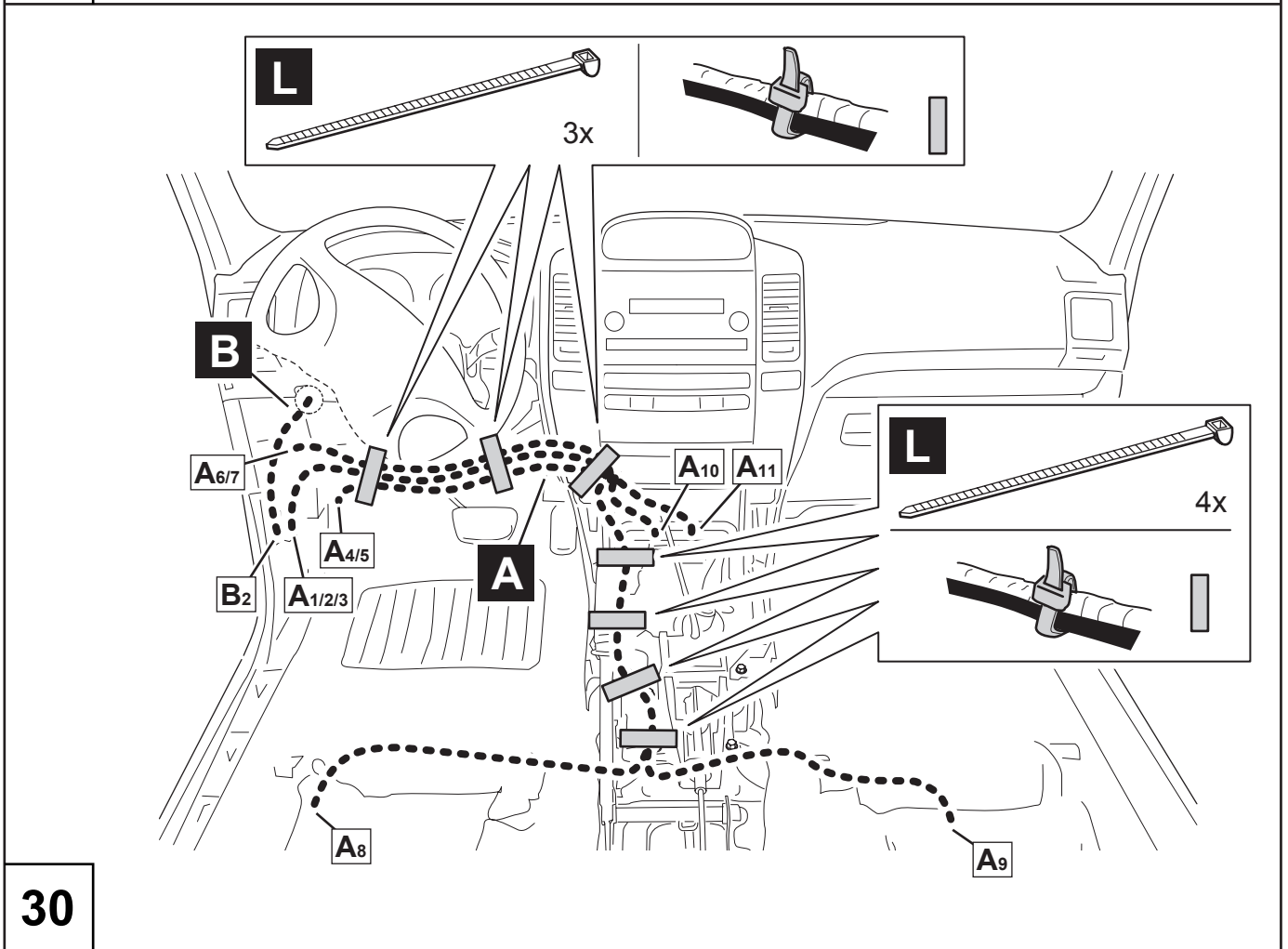
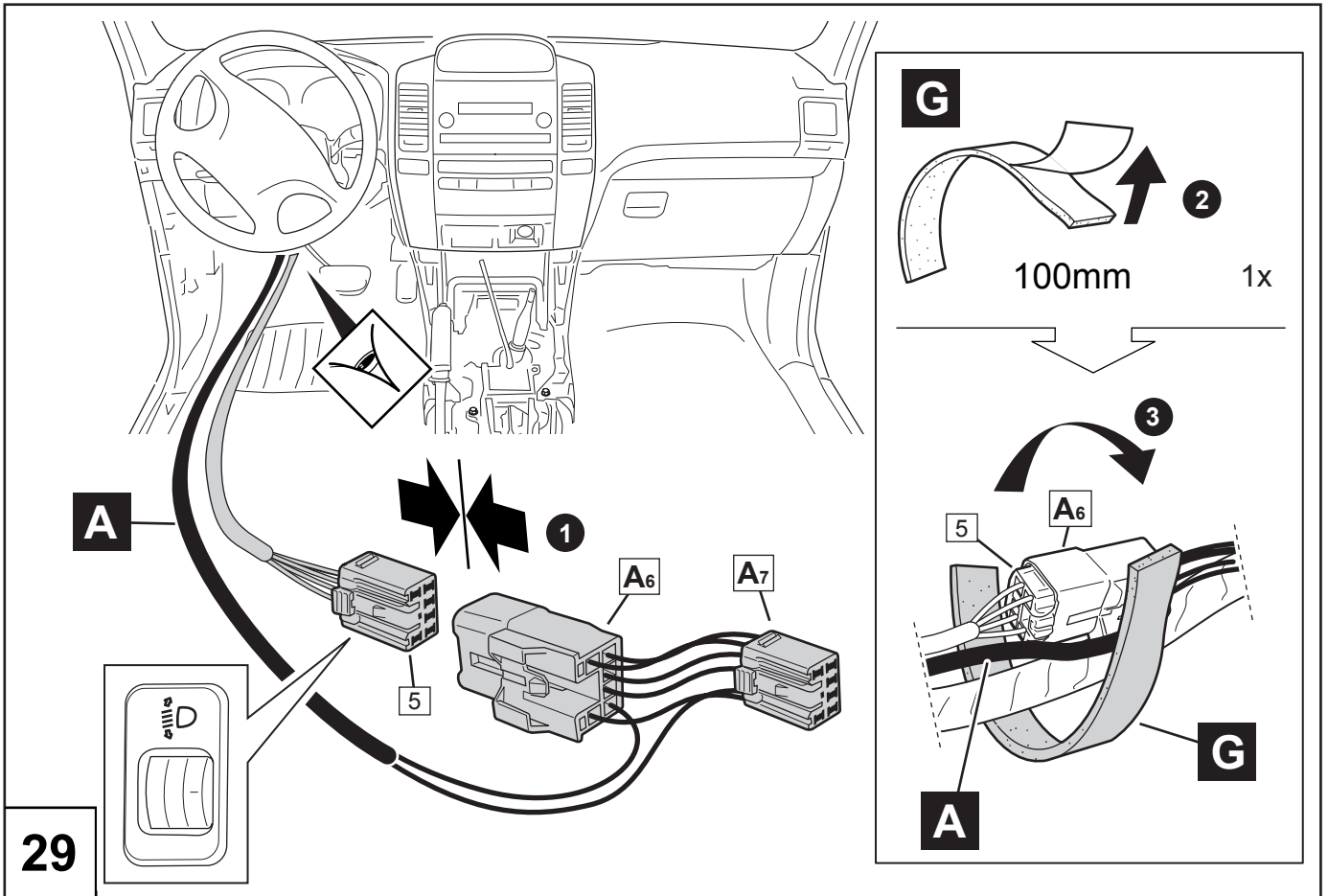

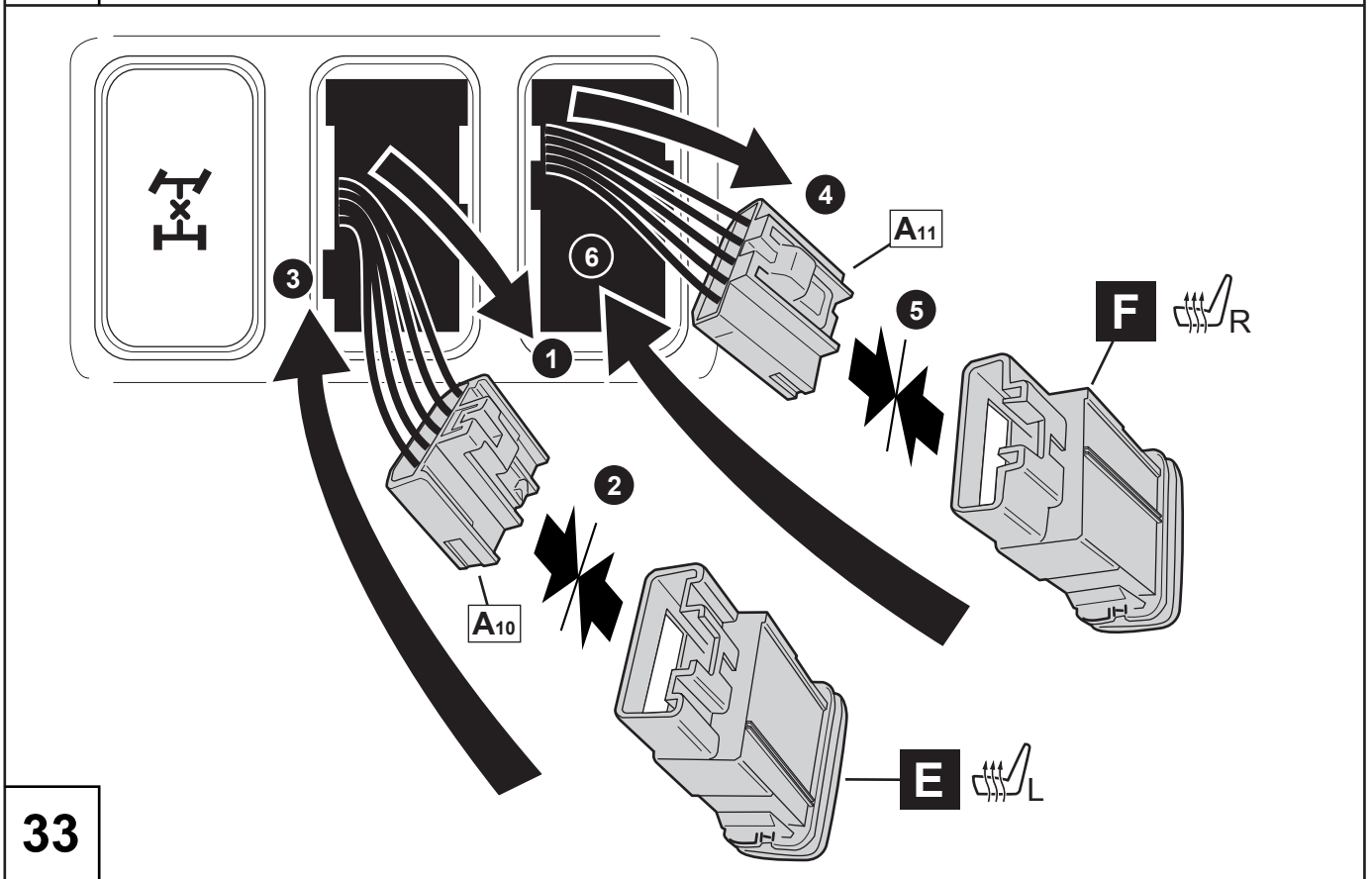
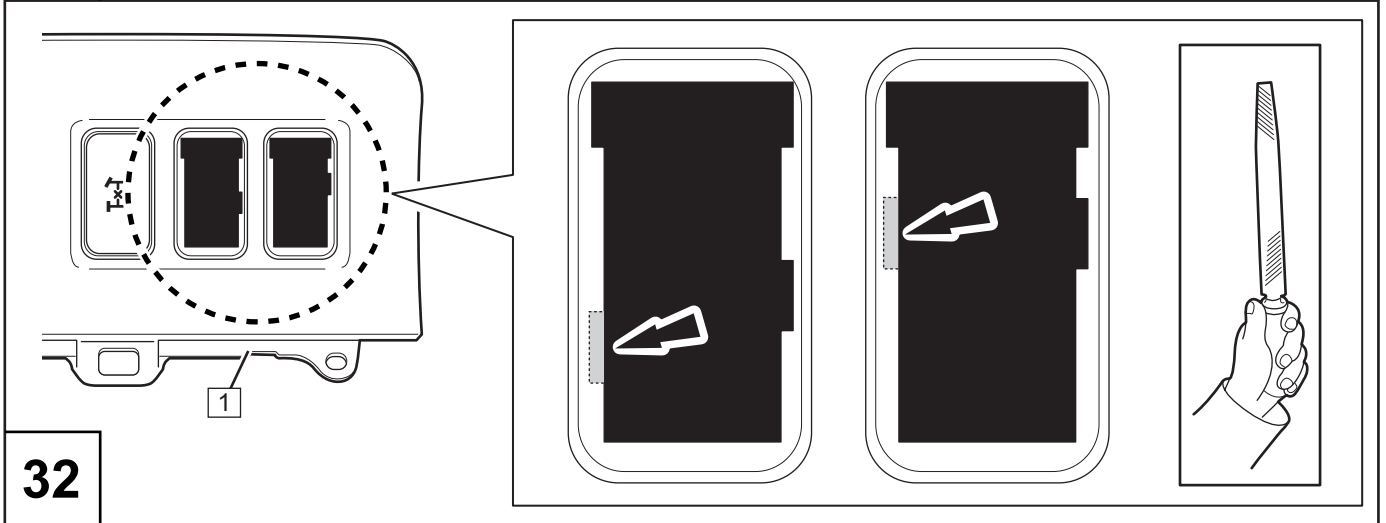
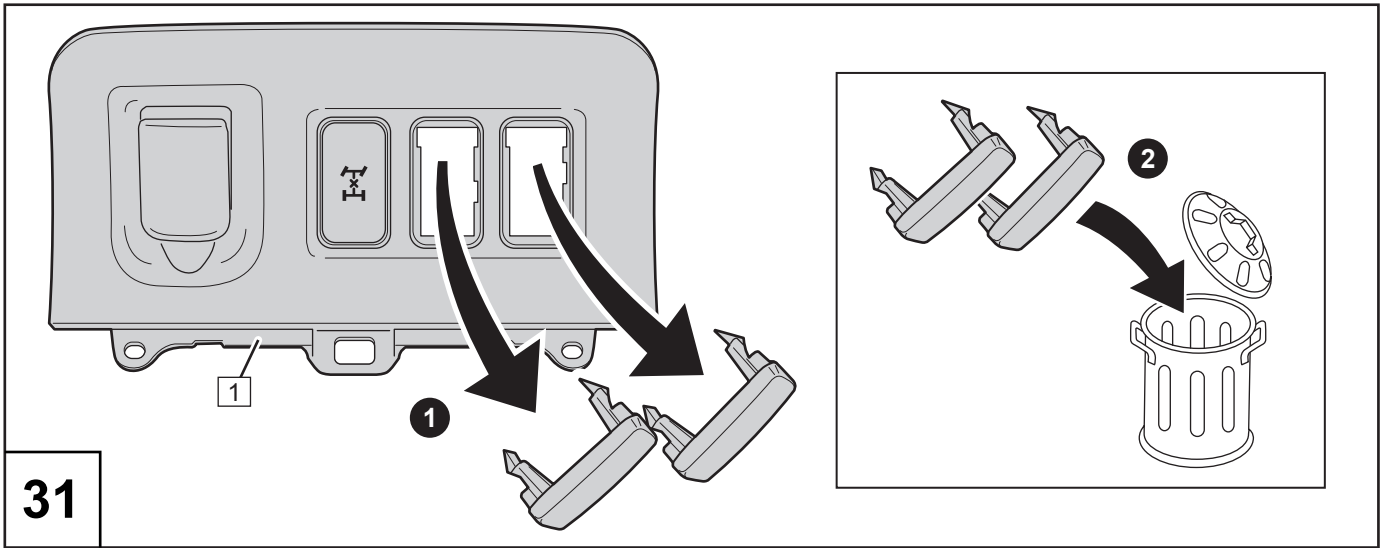

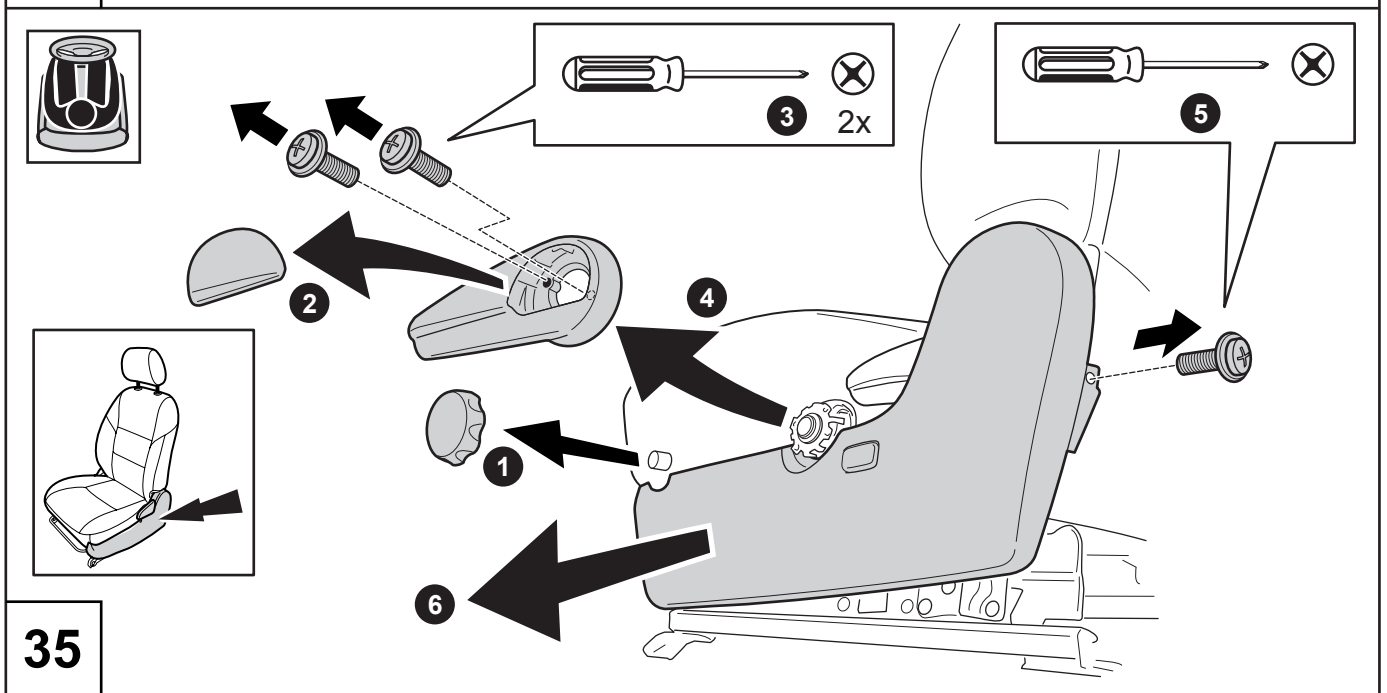
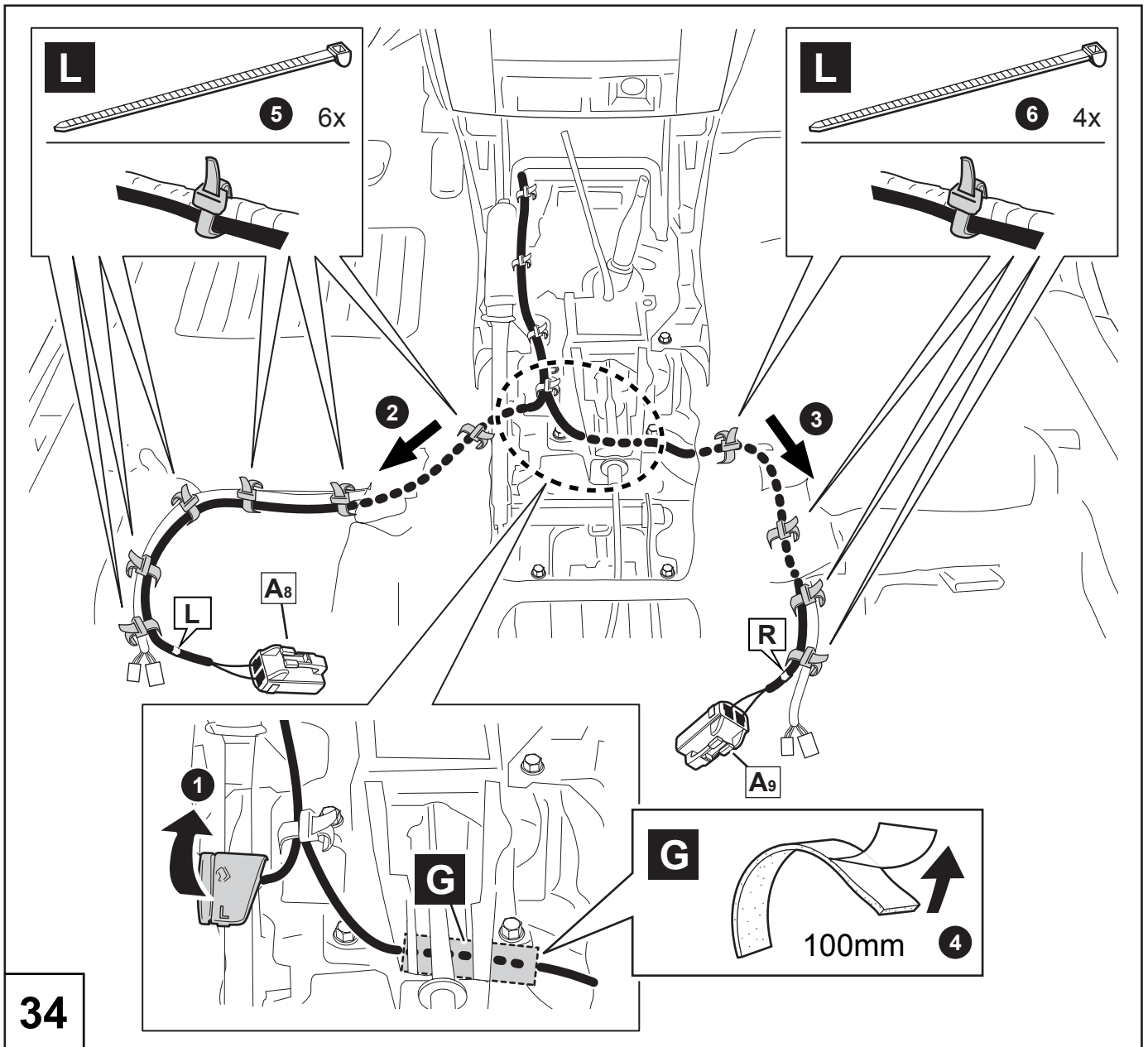

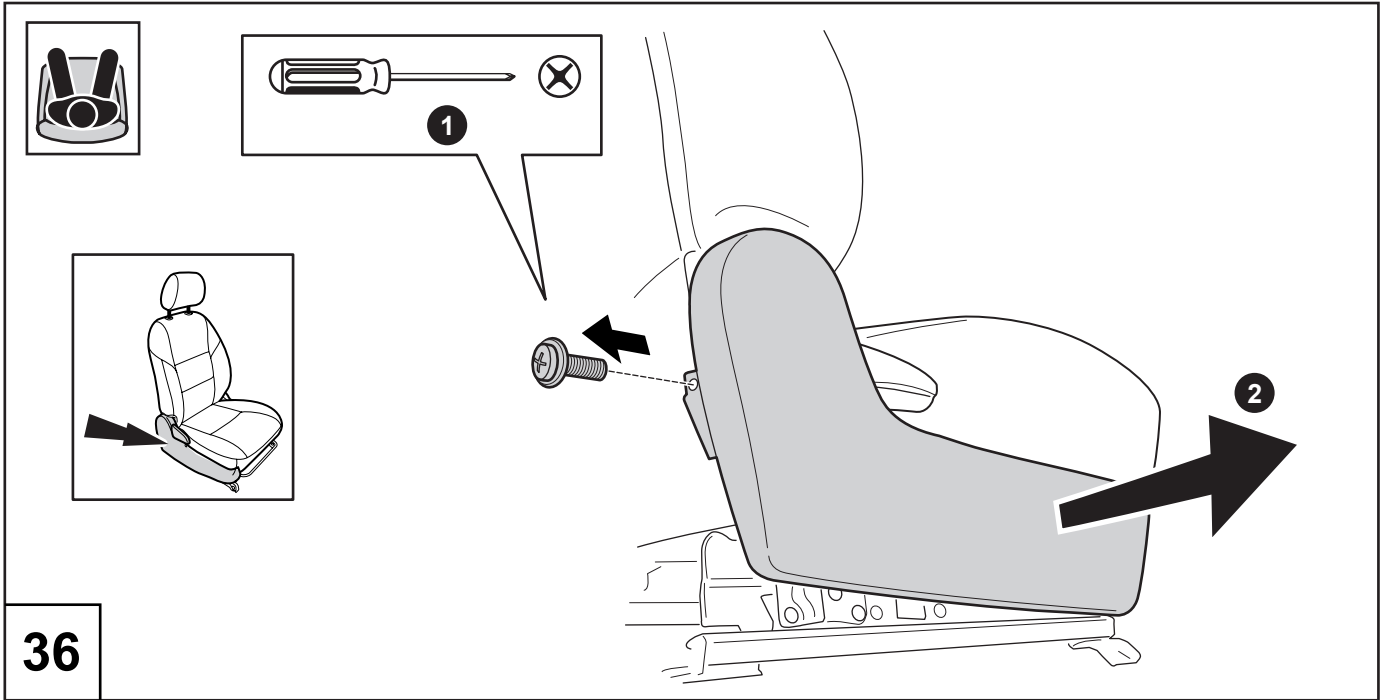

36

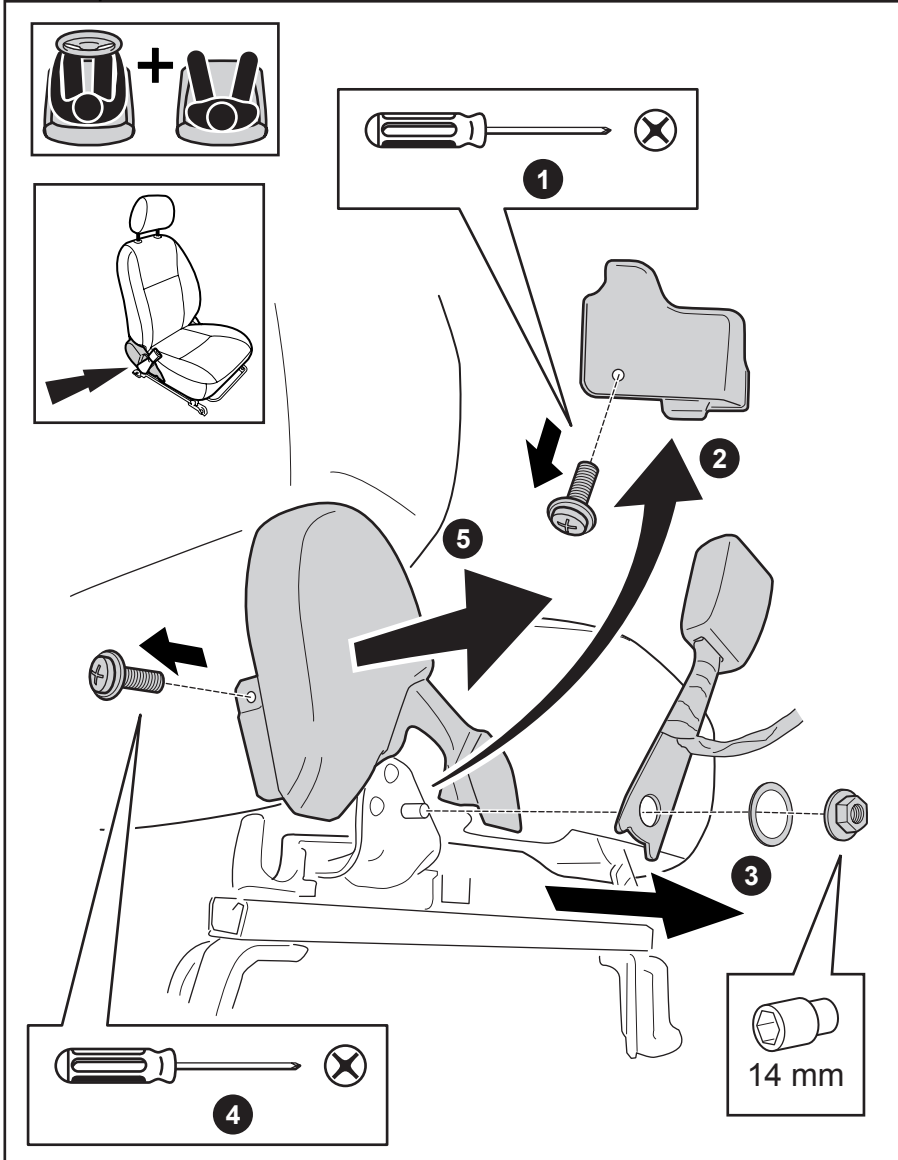

37

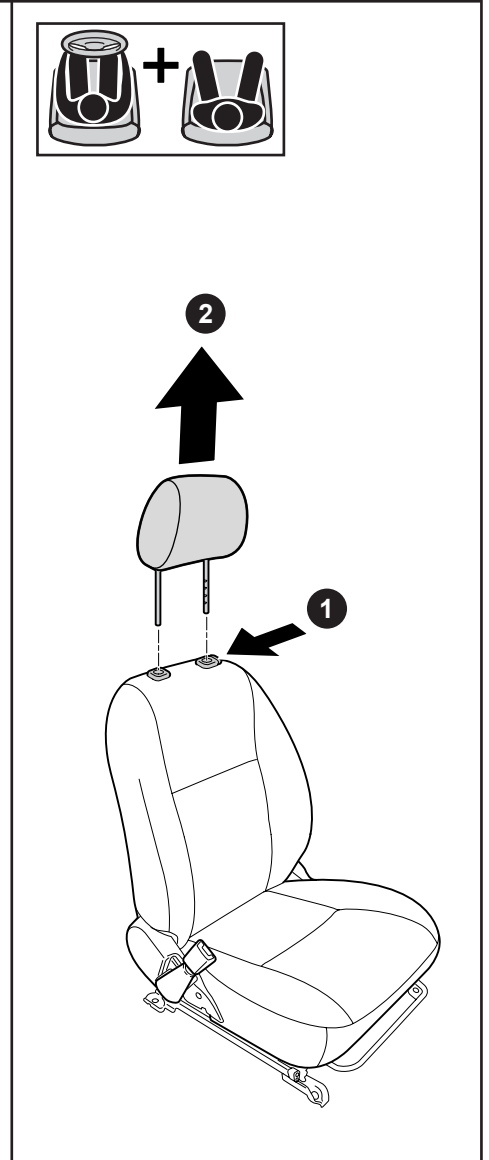

38

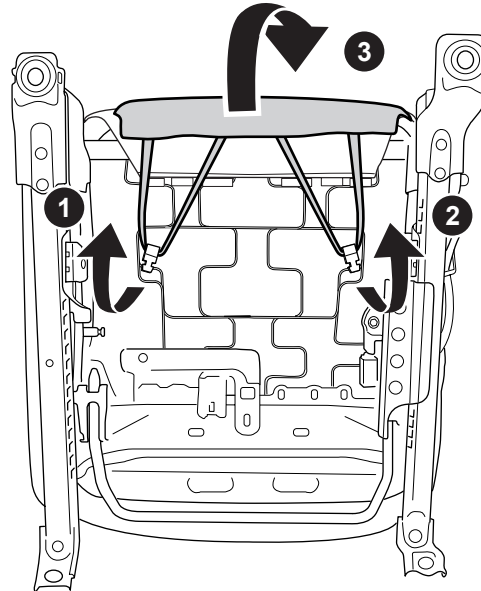
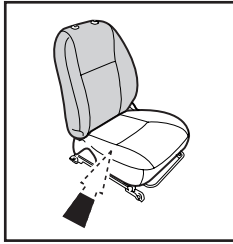
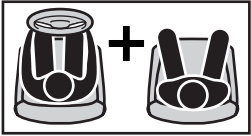

39

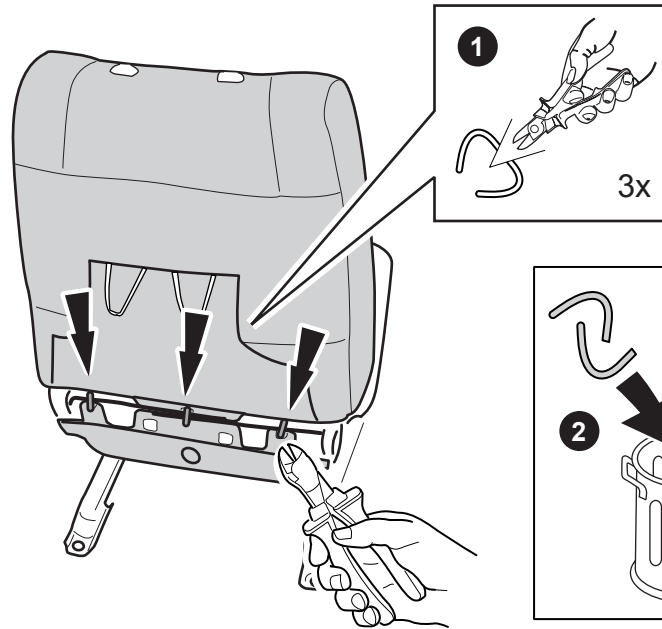
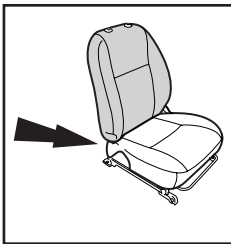
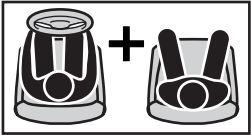

40

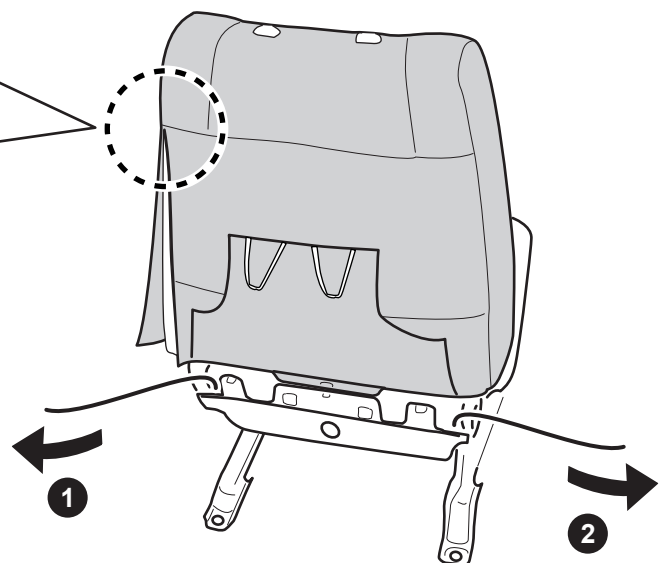
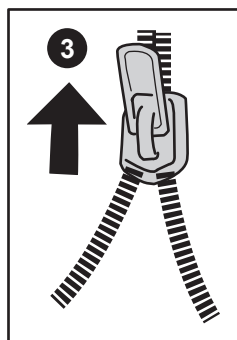
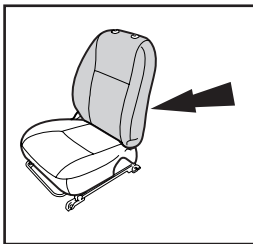
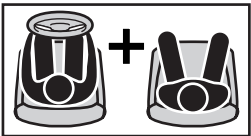

41

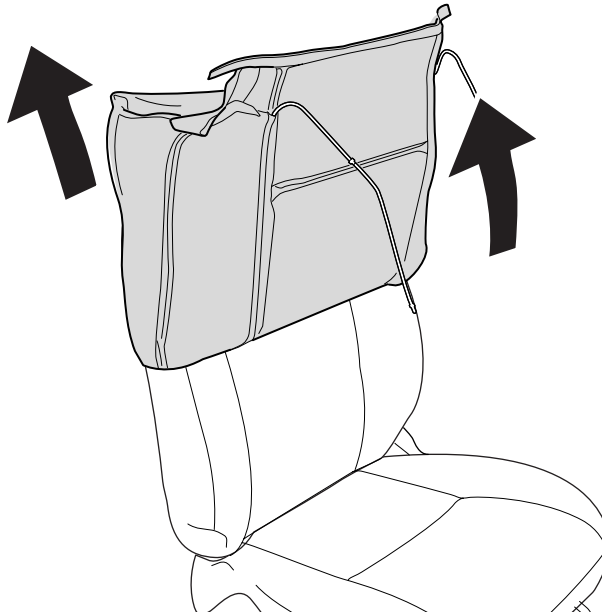
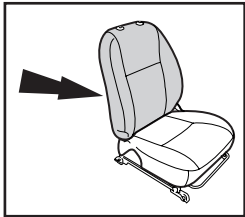
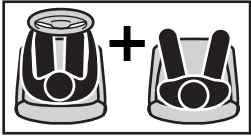

42

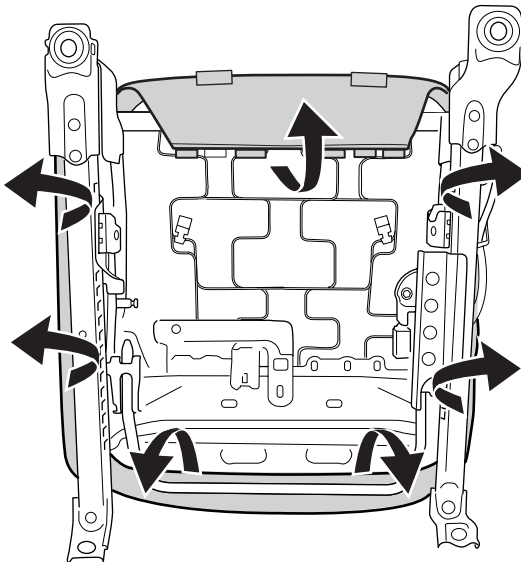
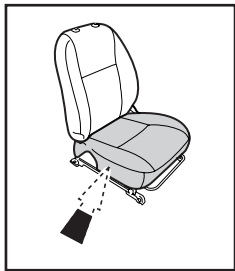
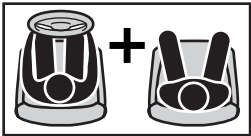

43

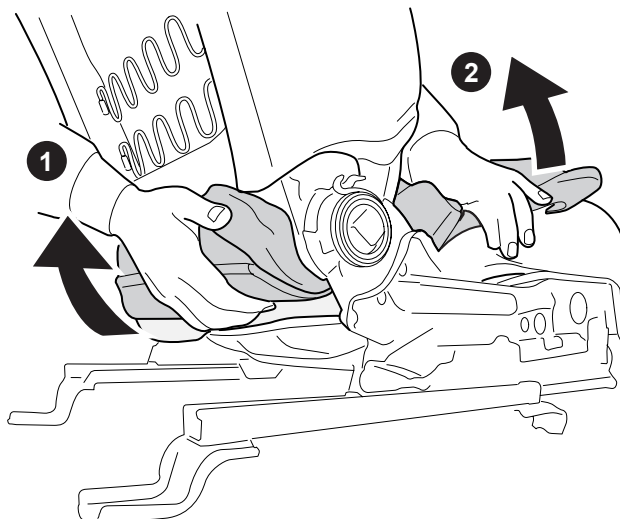
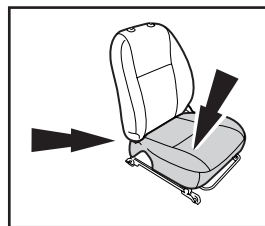
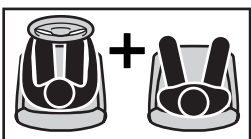

44

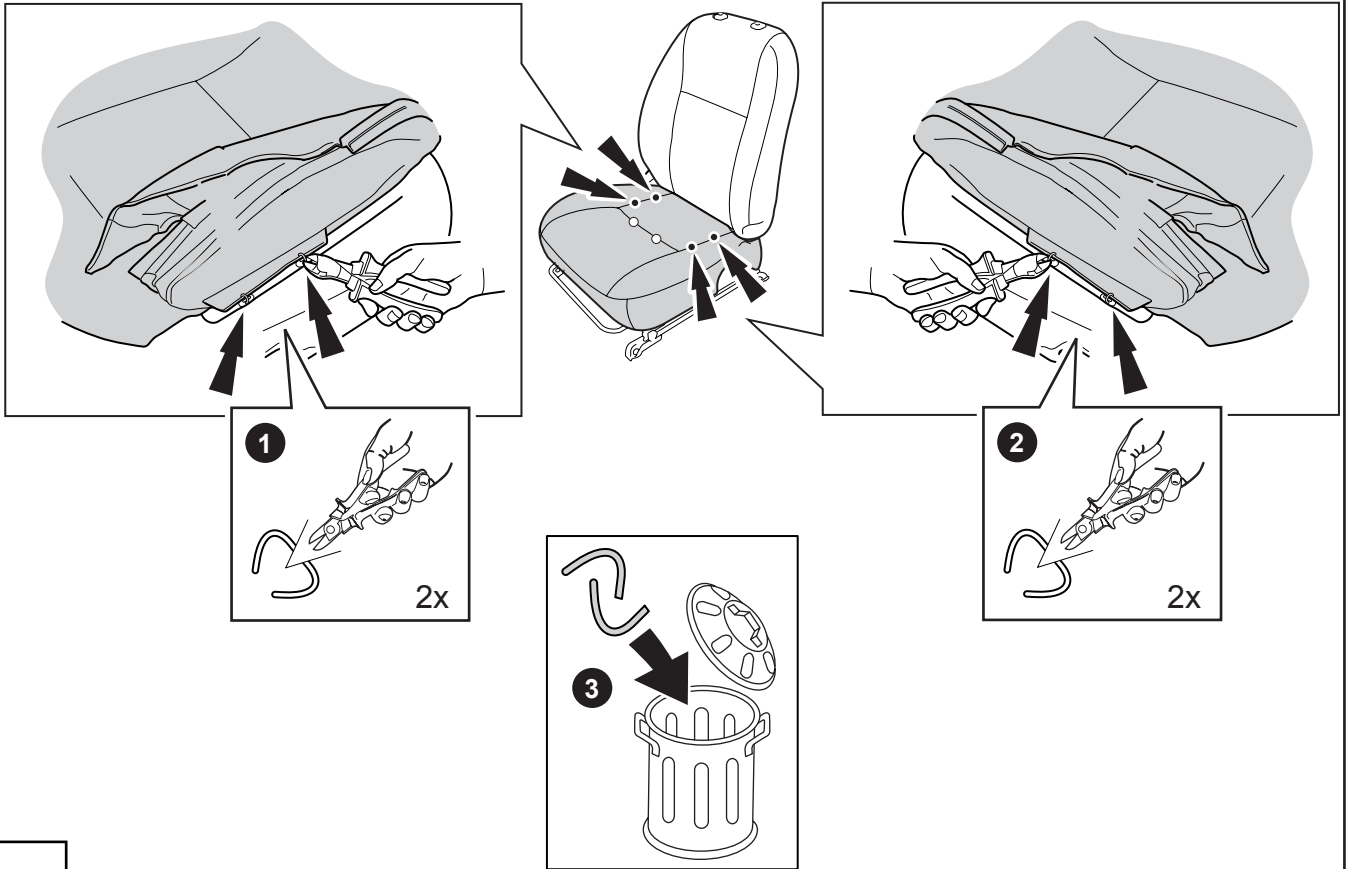
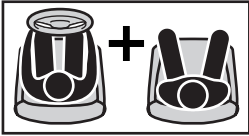

45

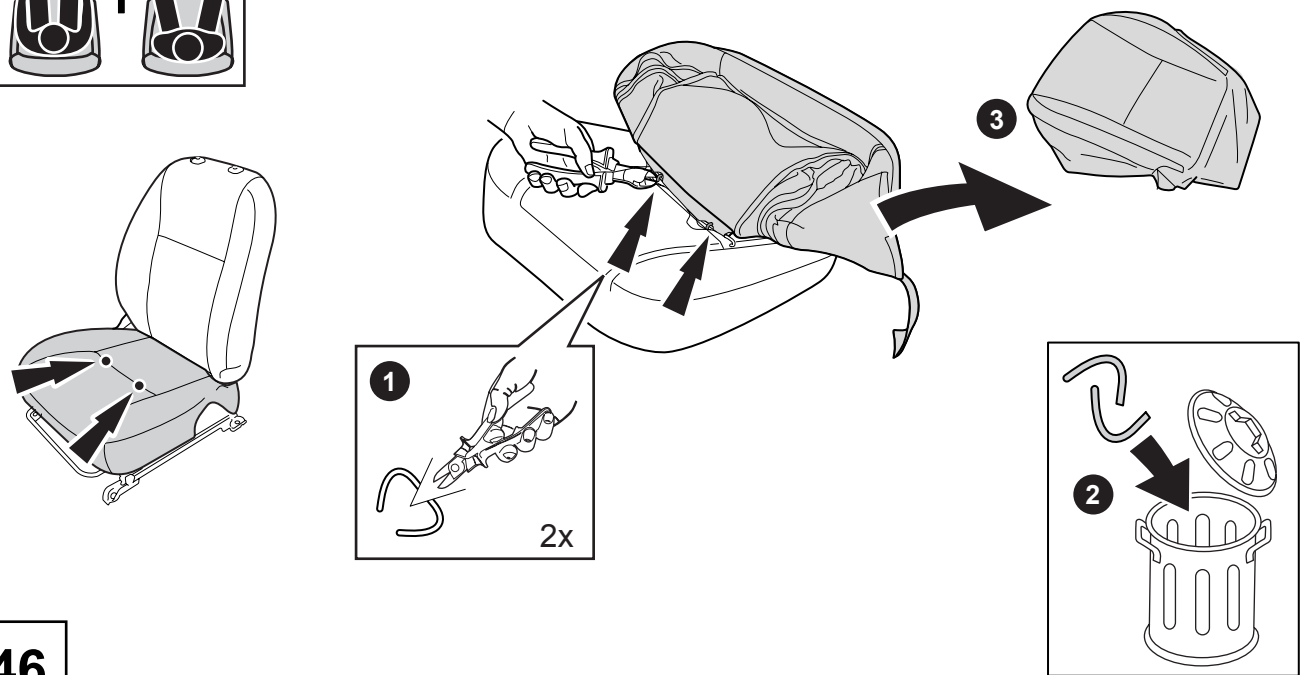
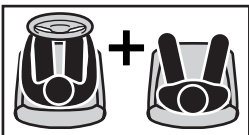

46

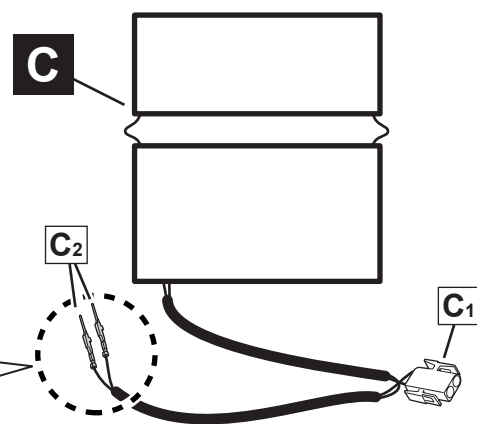
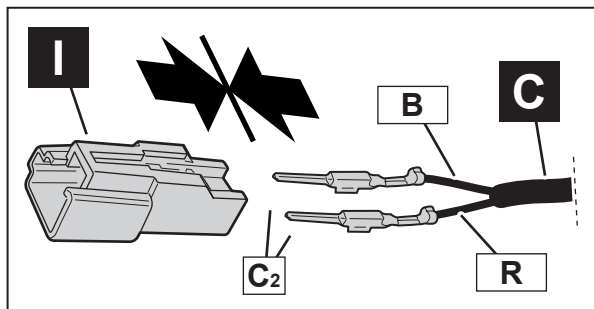
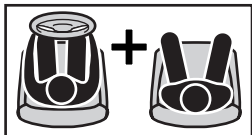

47

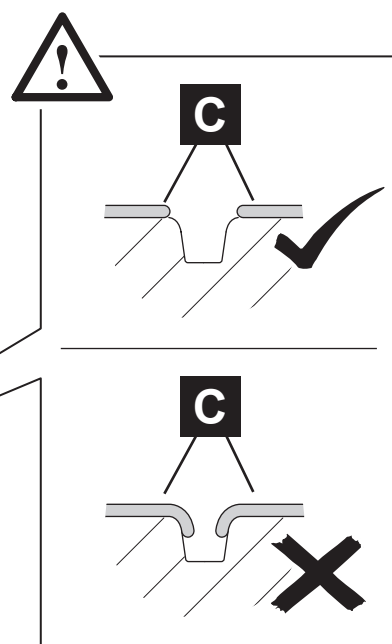
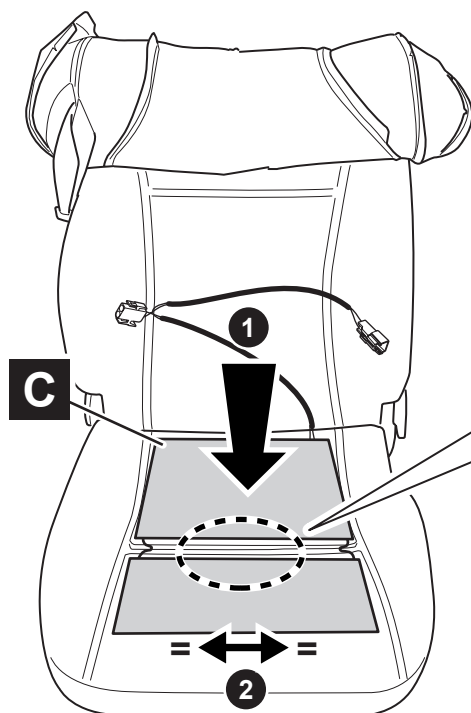
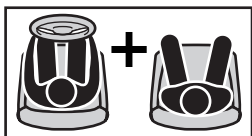

48

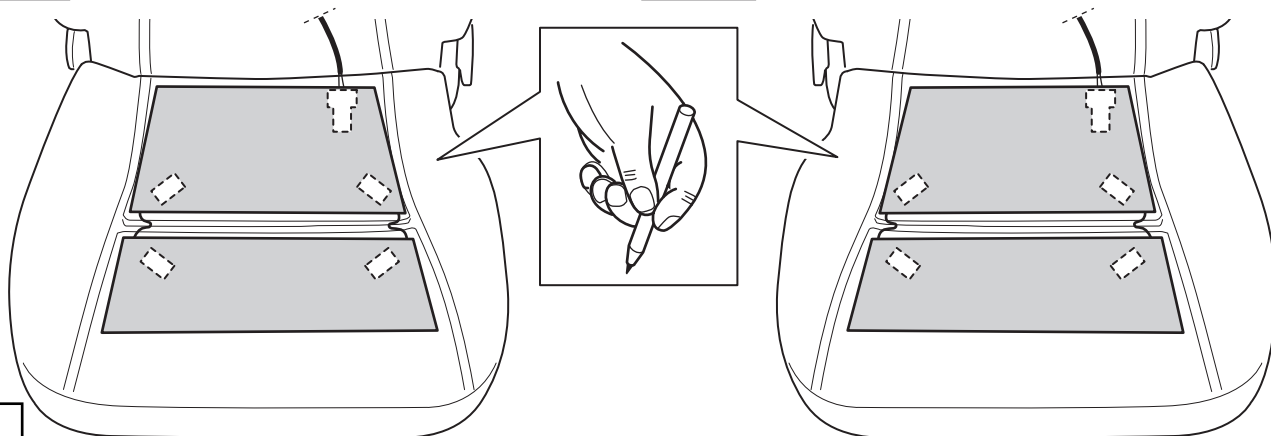

49

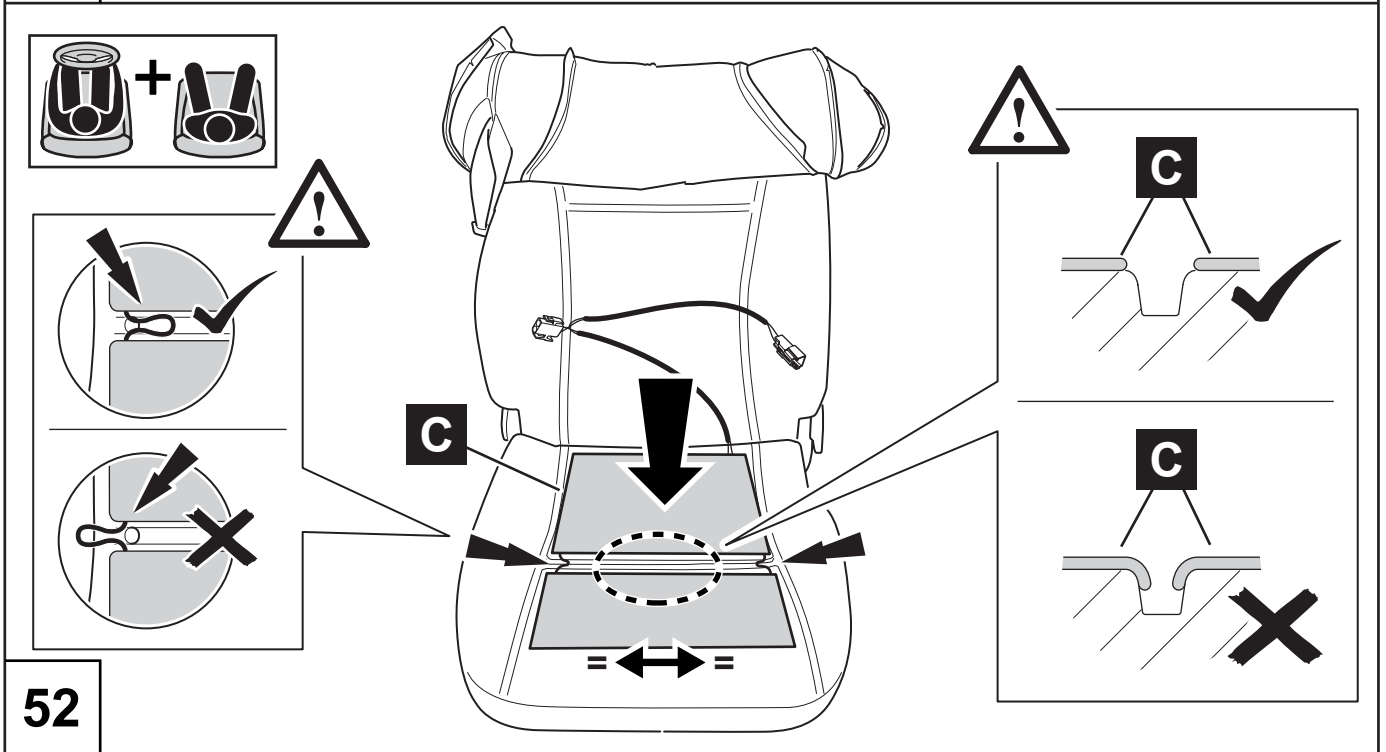
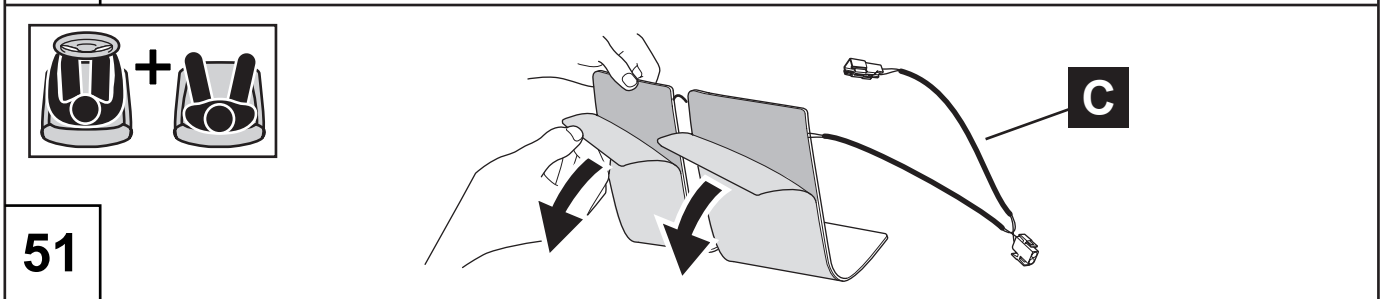
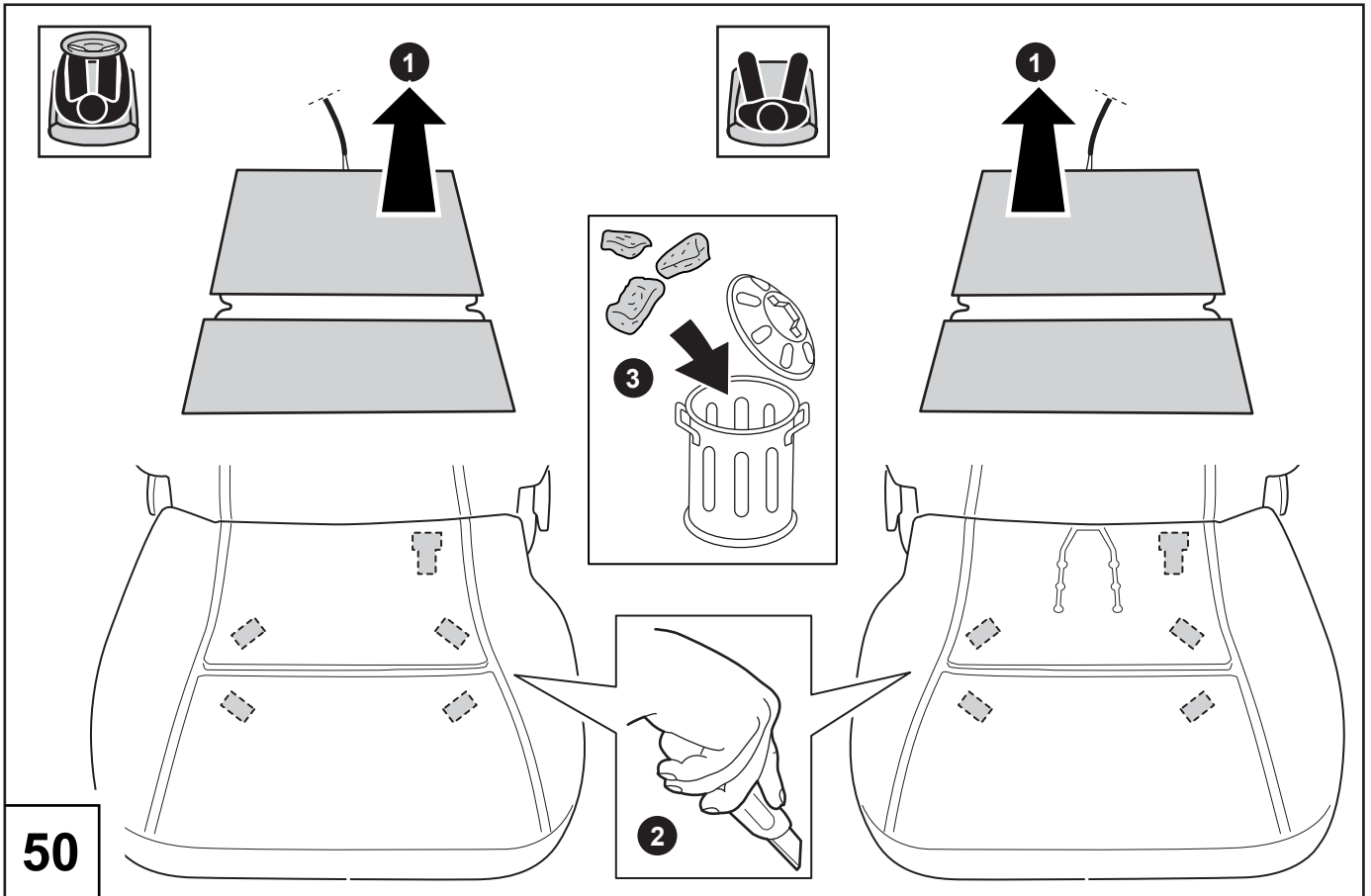

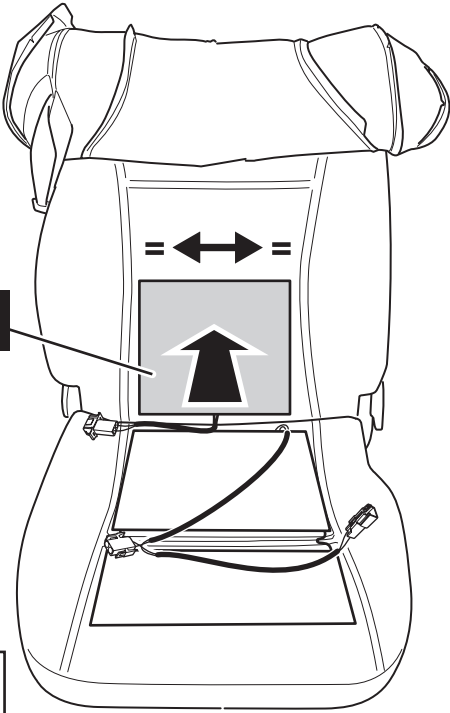
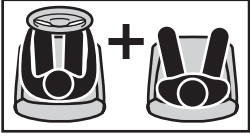

53

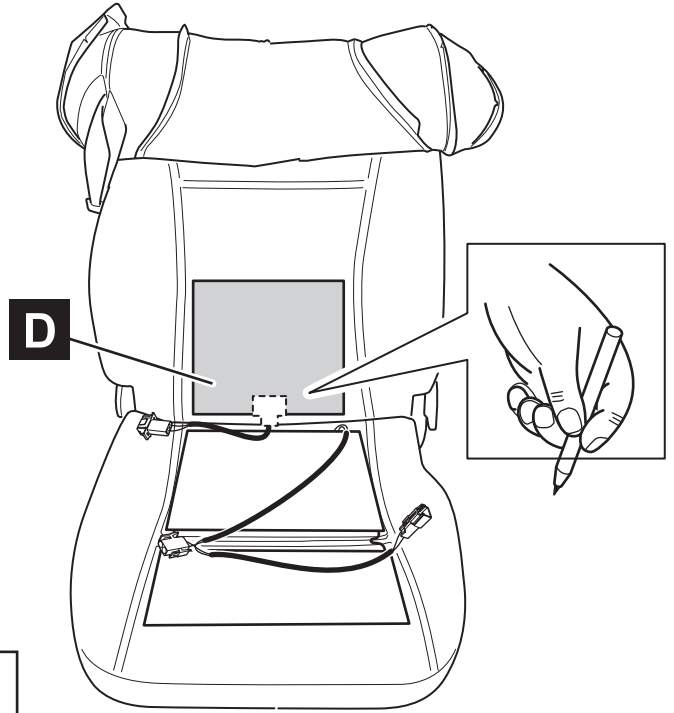
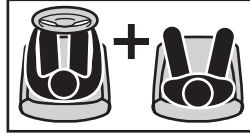

54

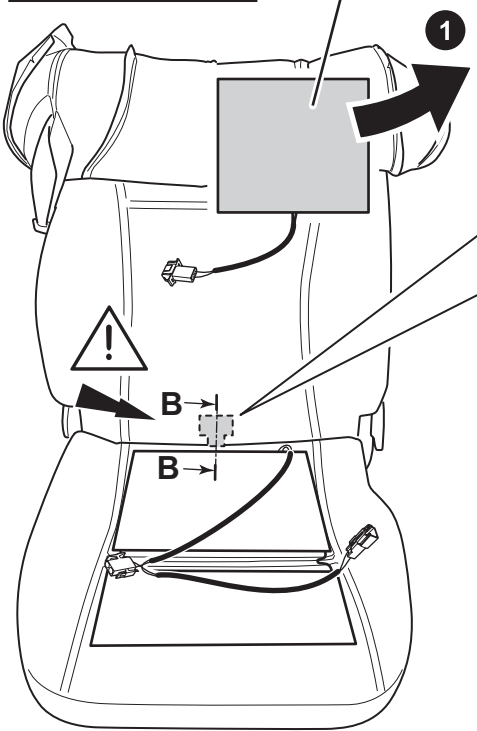

55

2

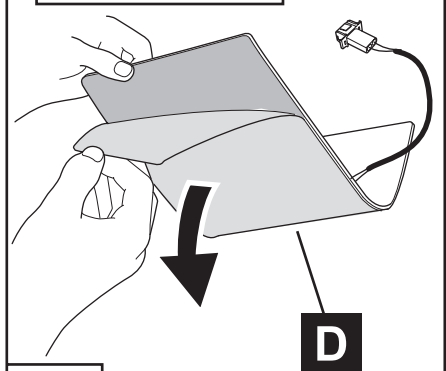
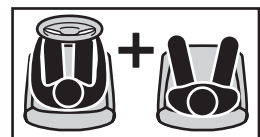
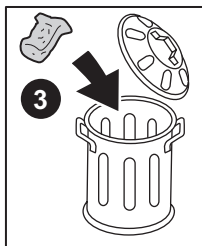
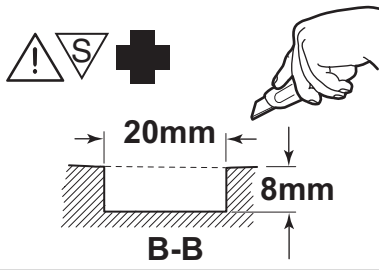
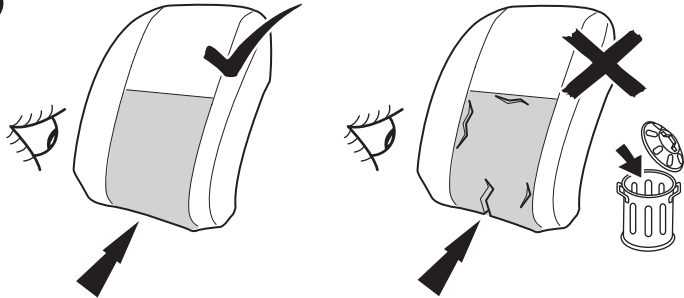

56

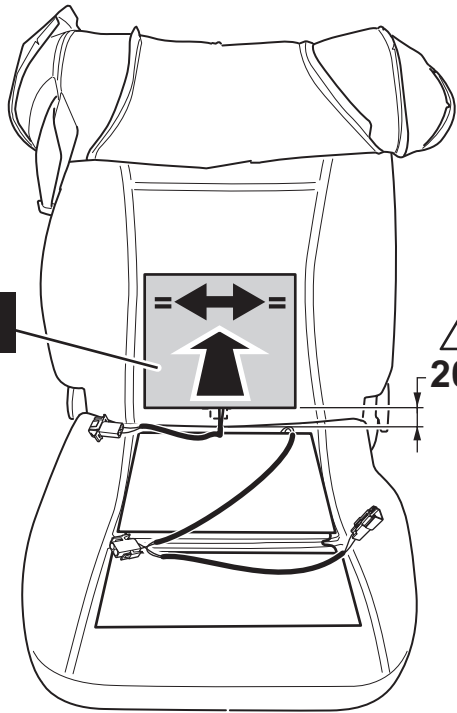
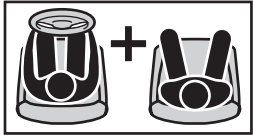

57

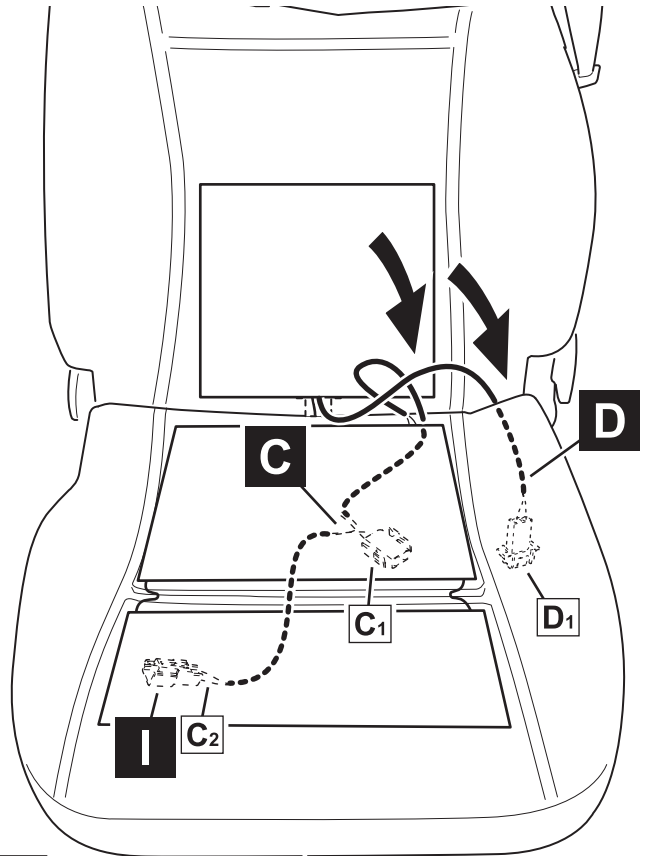
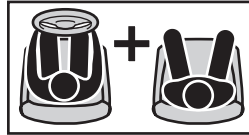

58

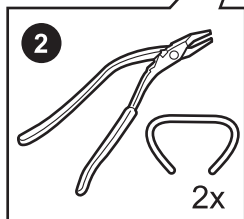
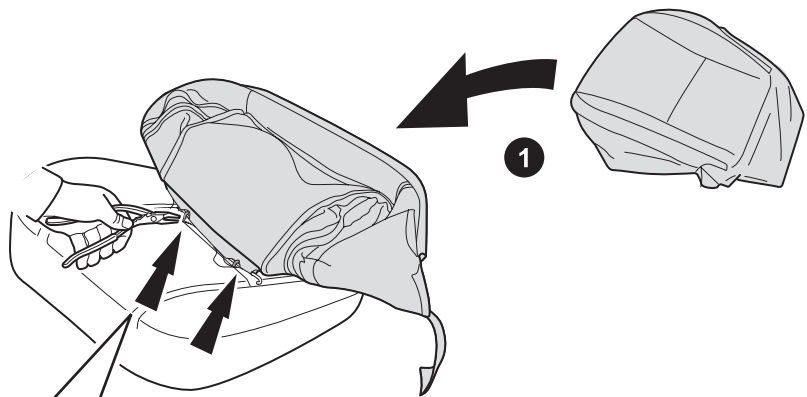
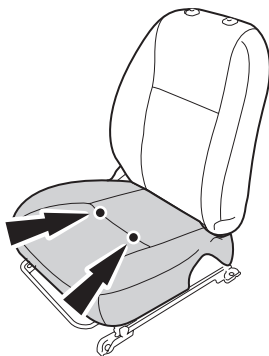
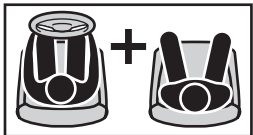

59

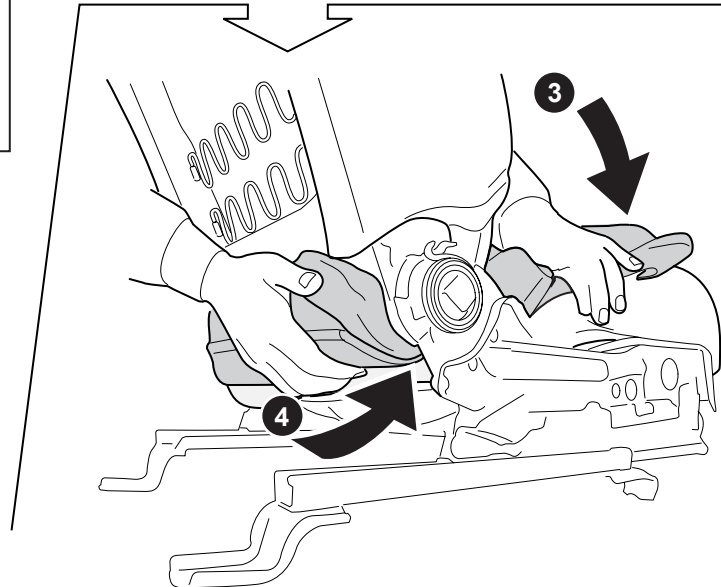
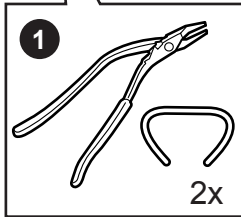
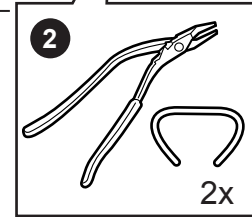
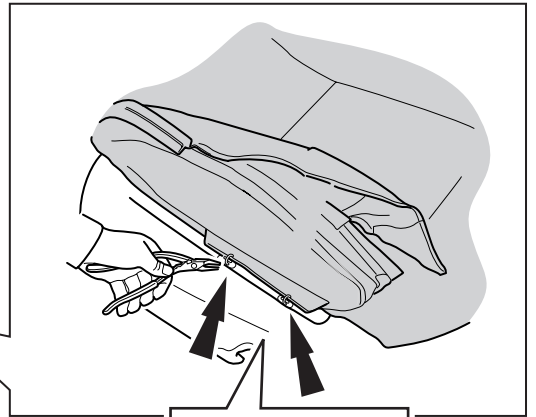
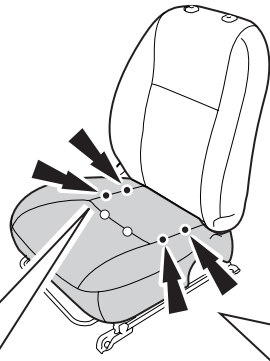
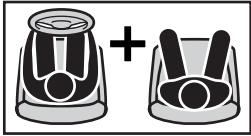

60

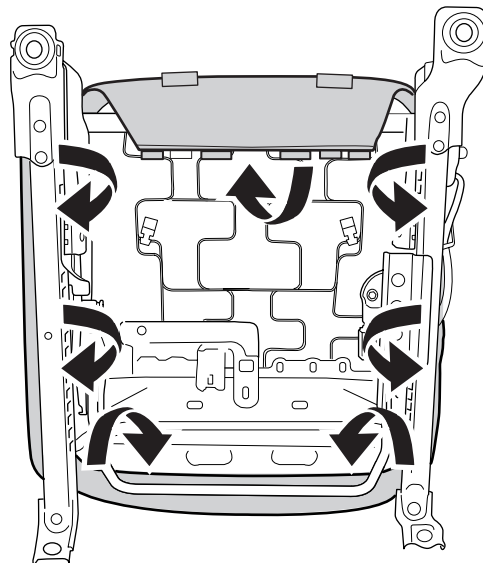
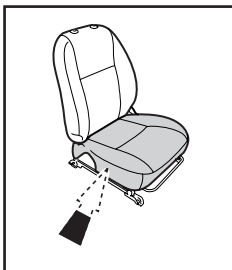
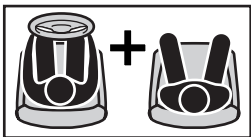

61

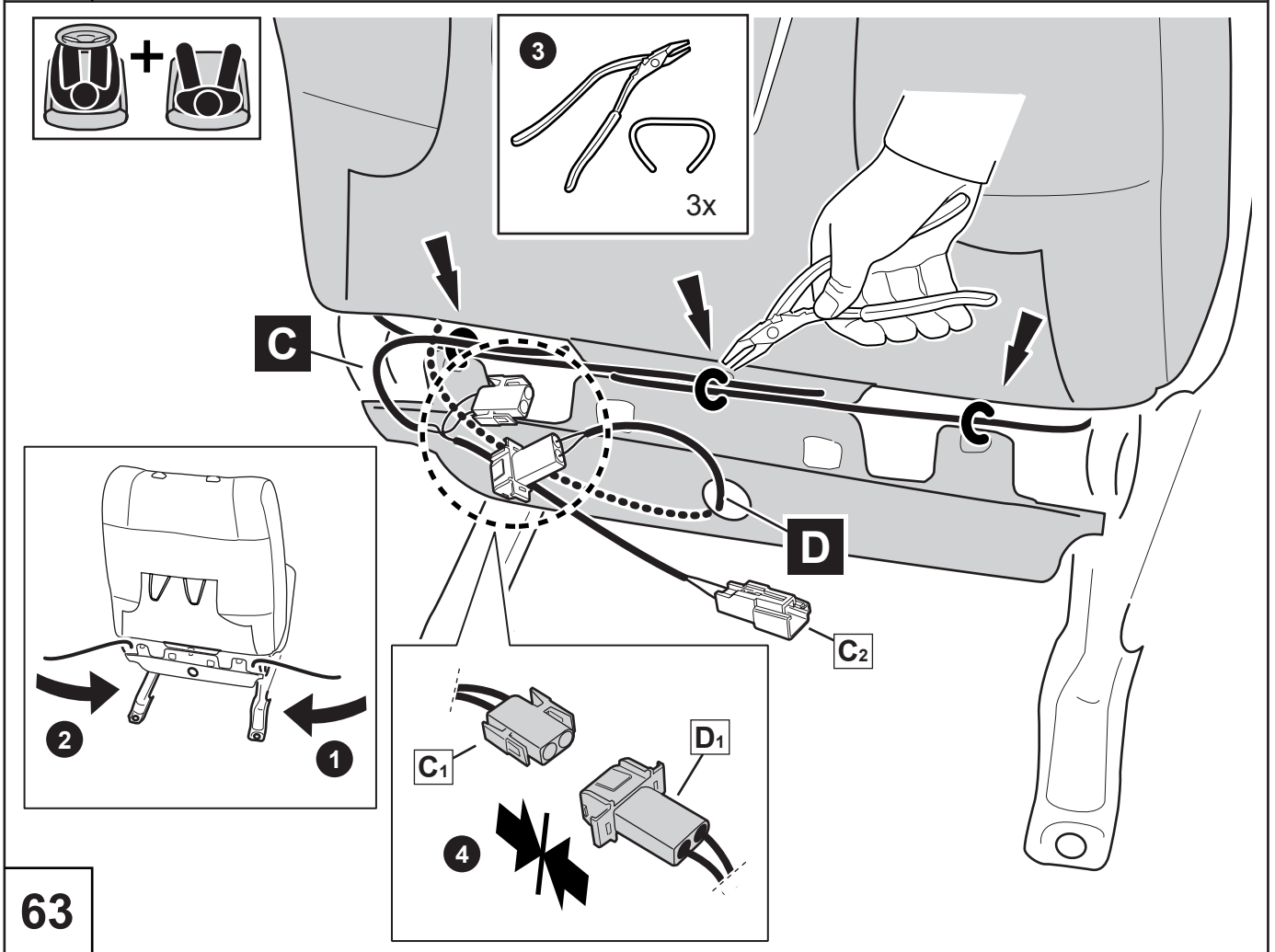
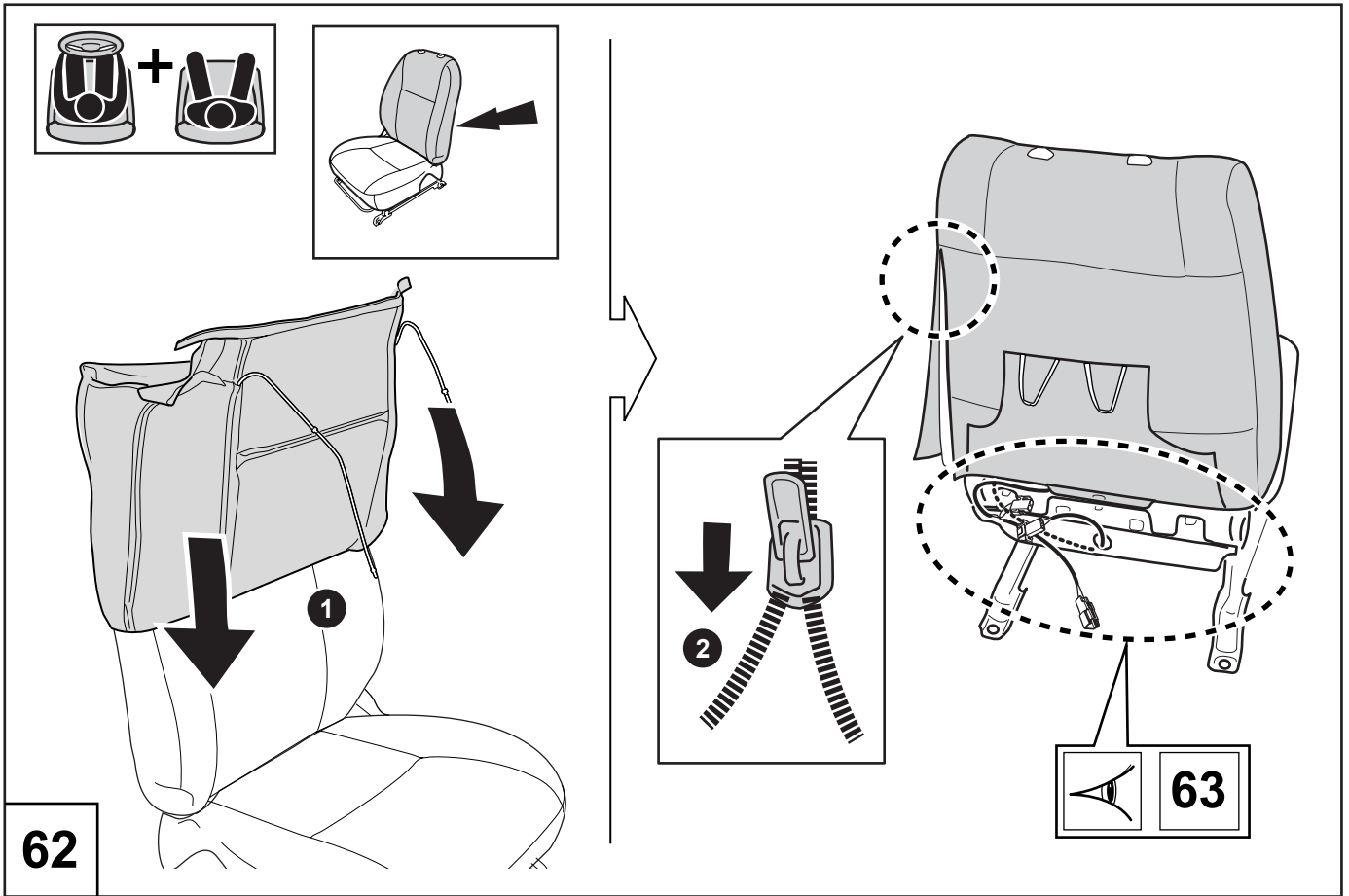

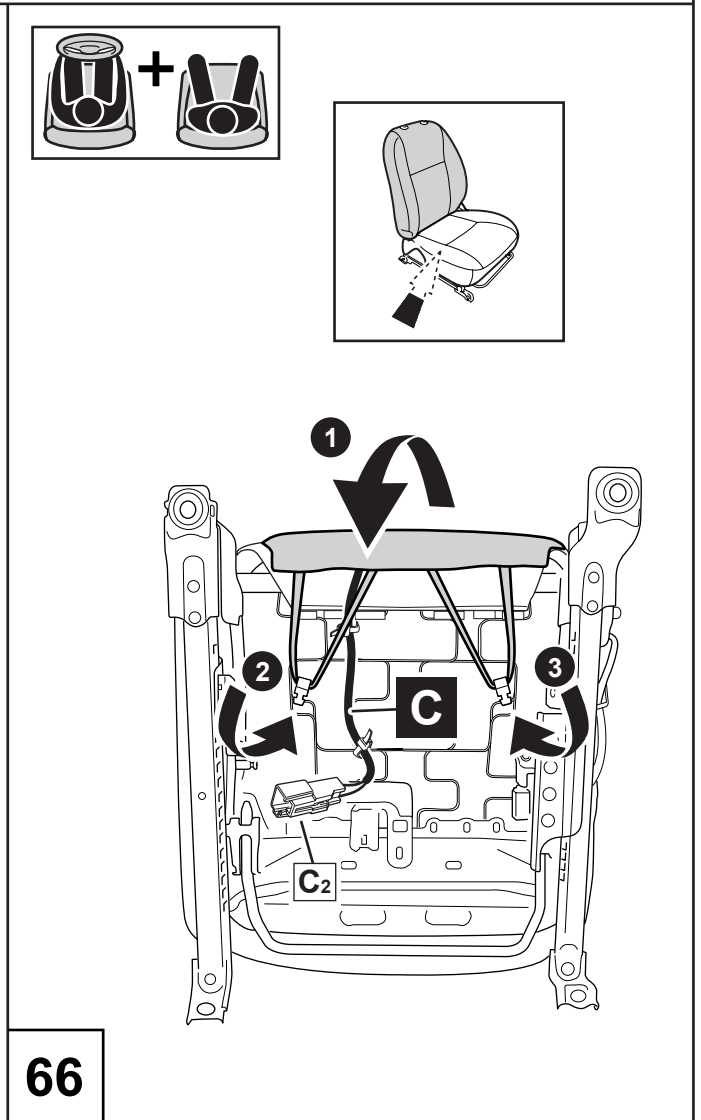
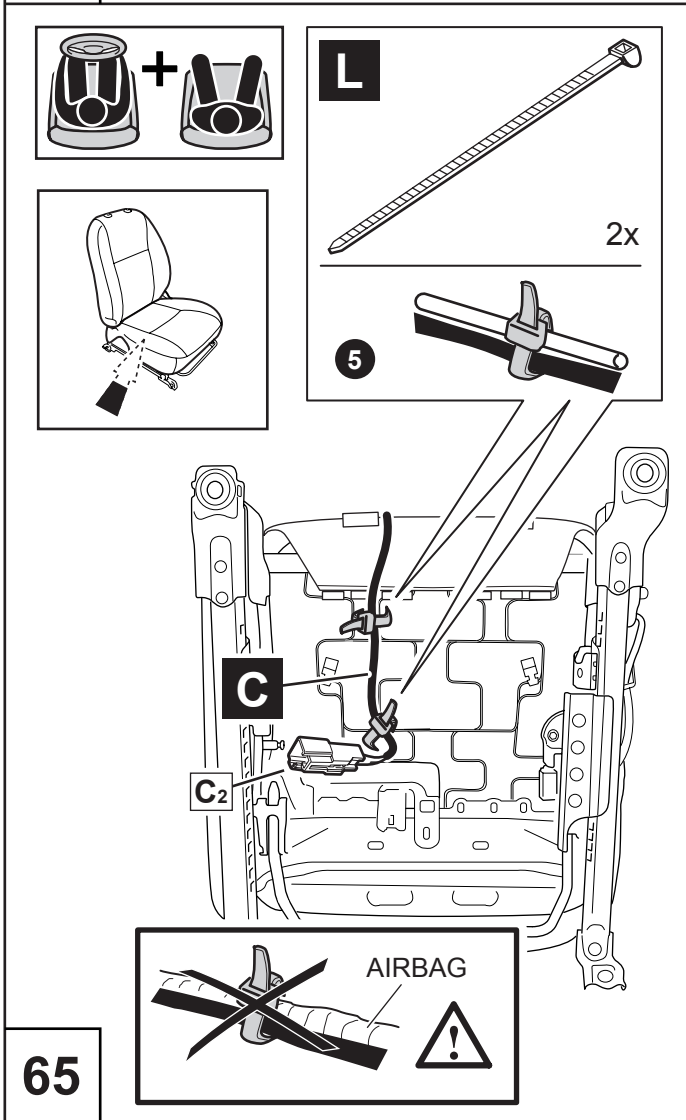
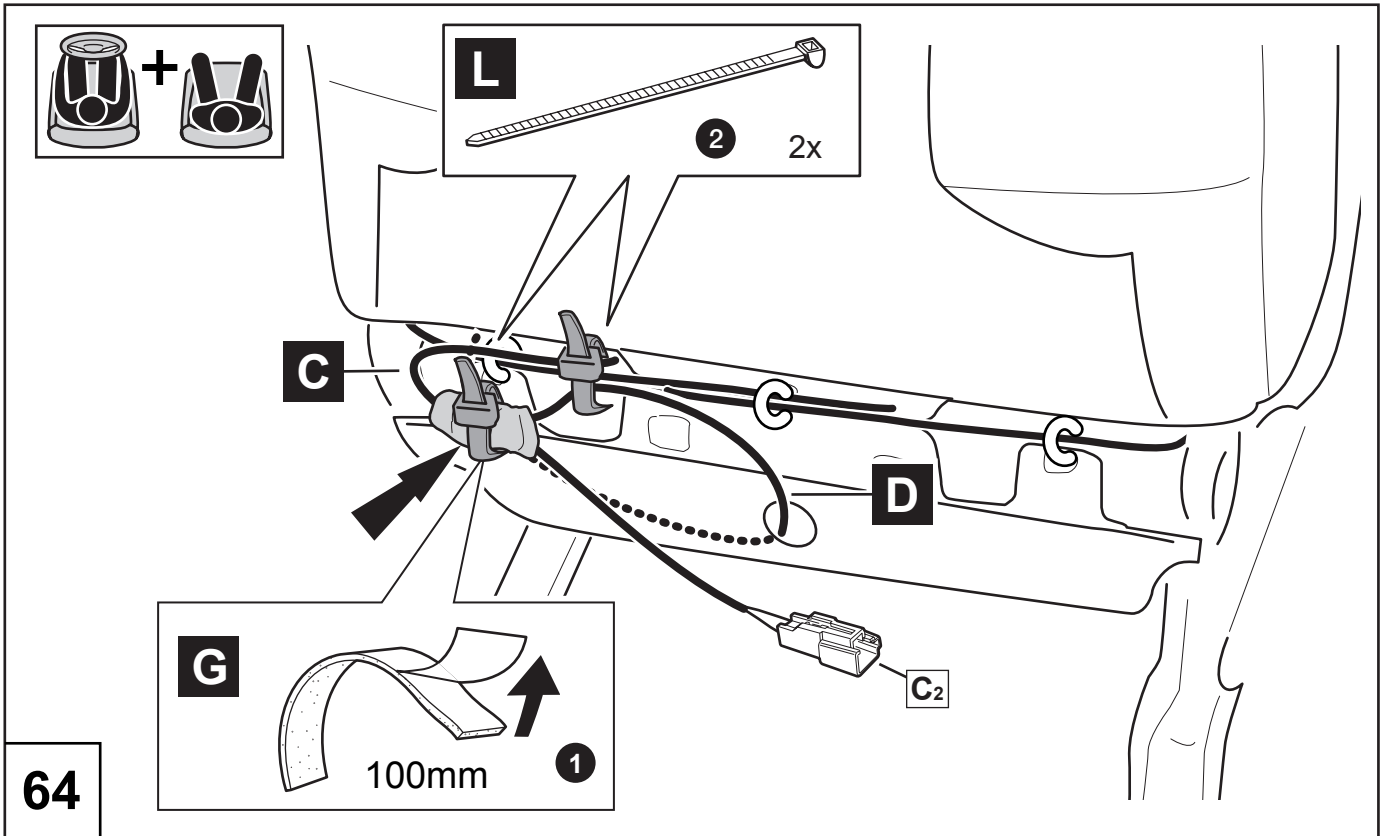

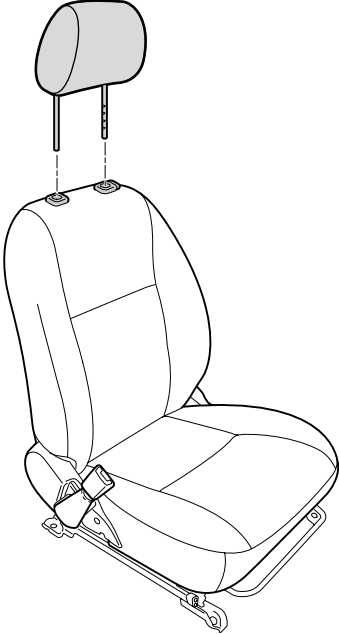
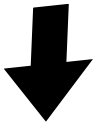
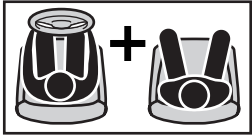

67

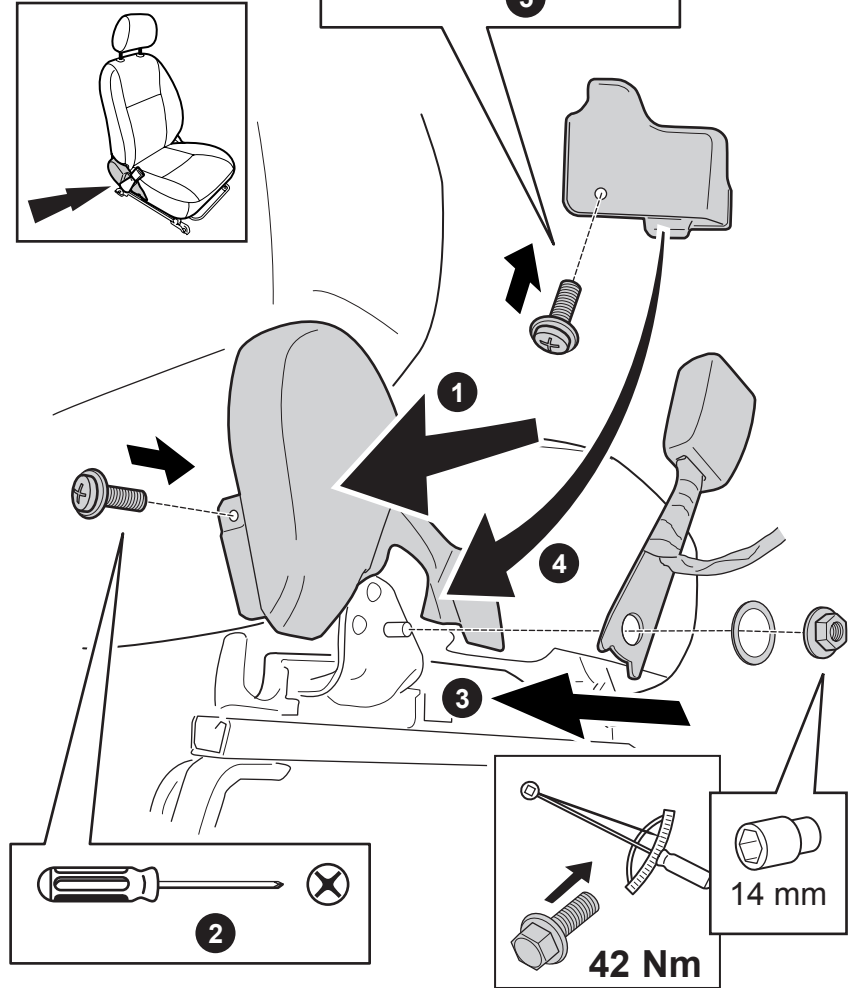
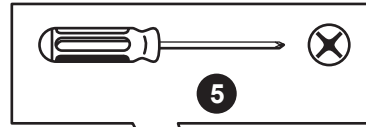
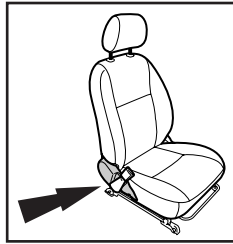
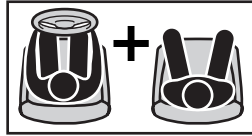

68

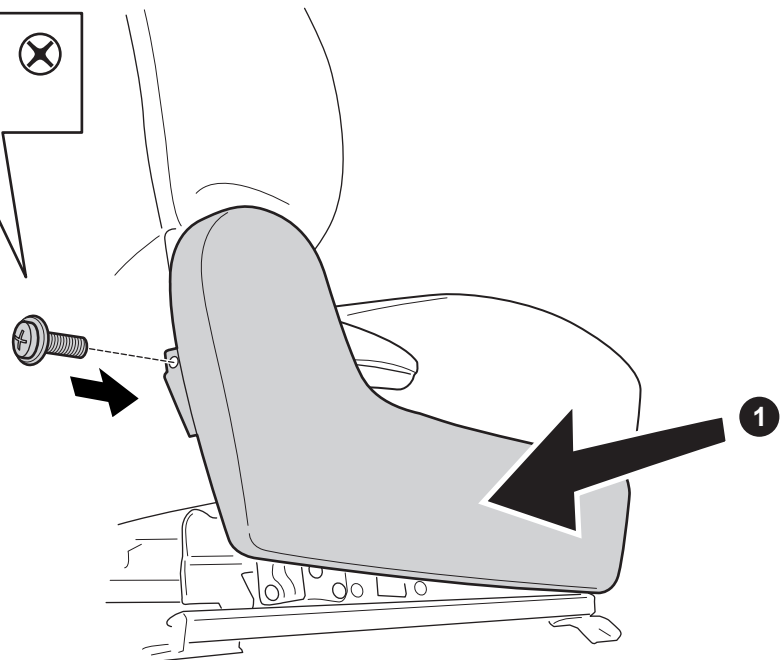
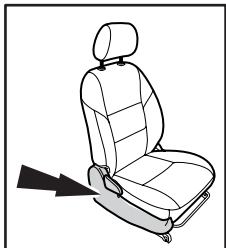
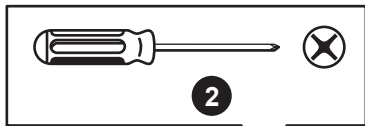

69

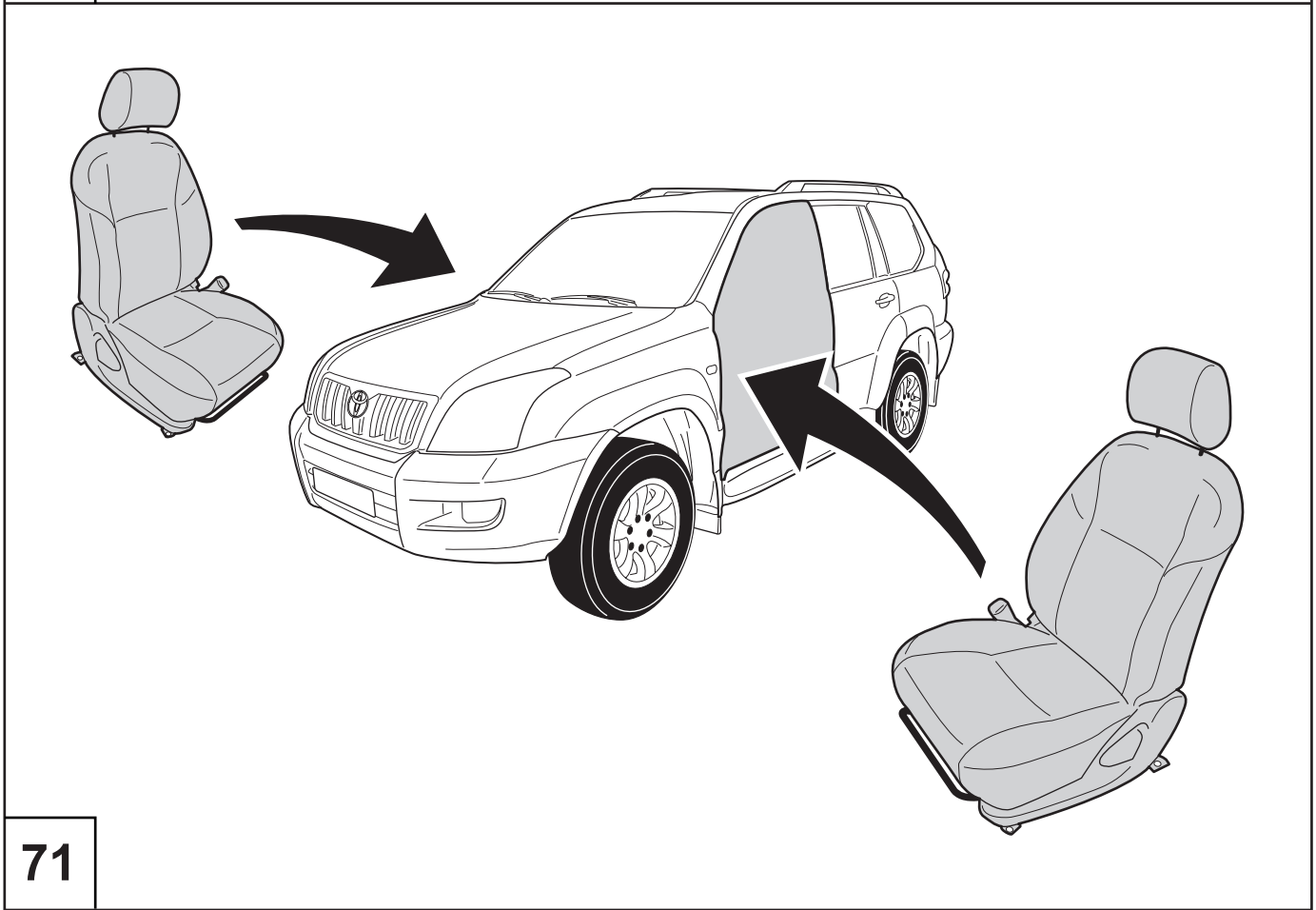
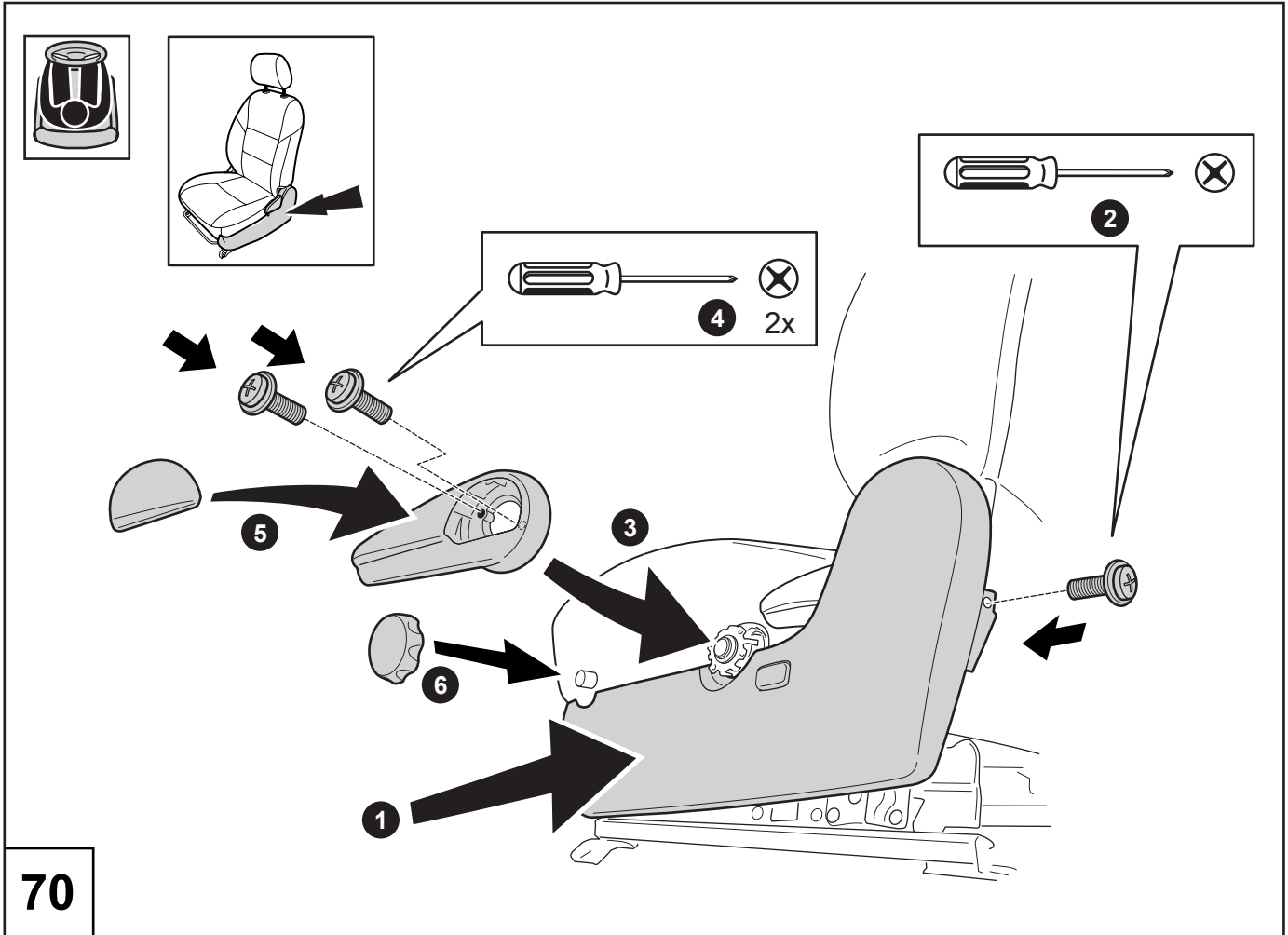

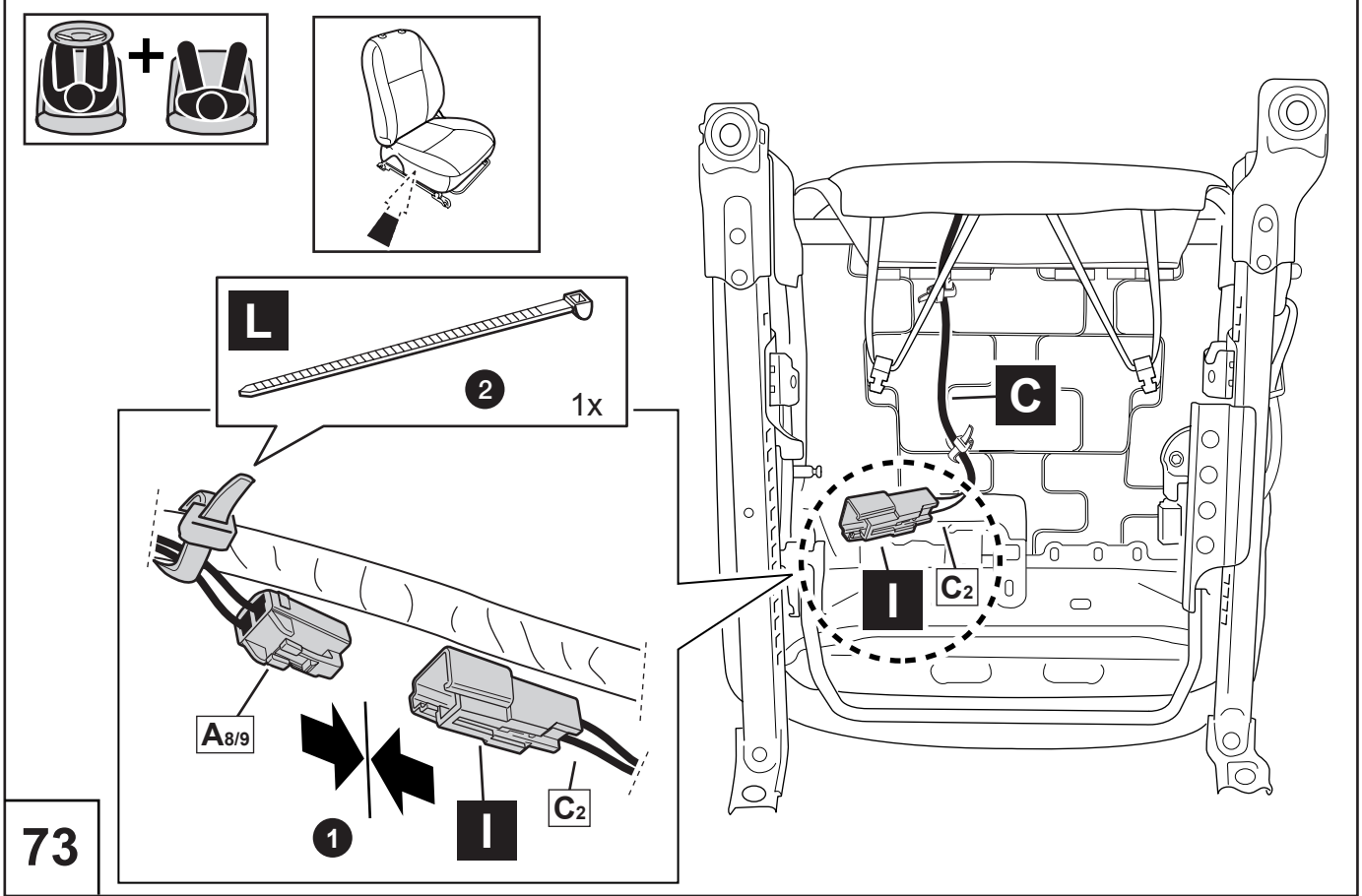
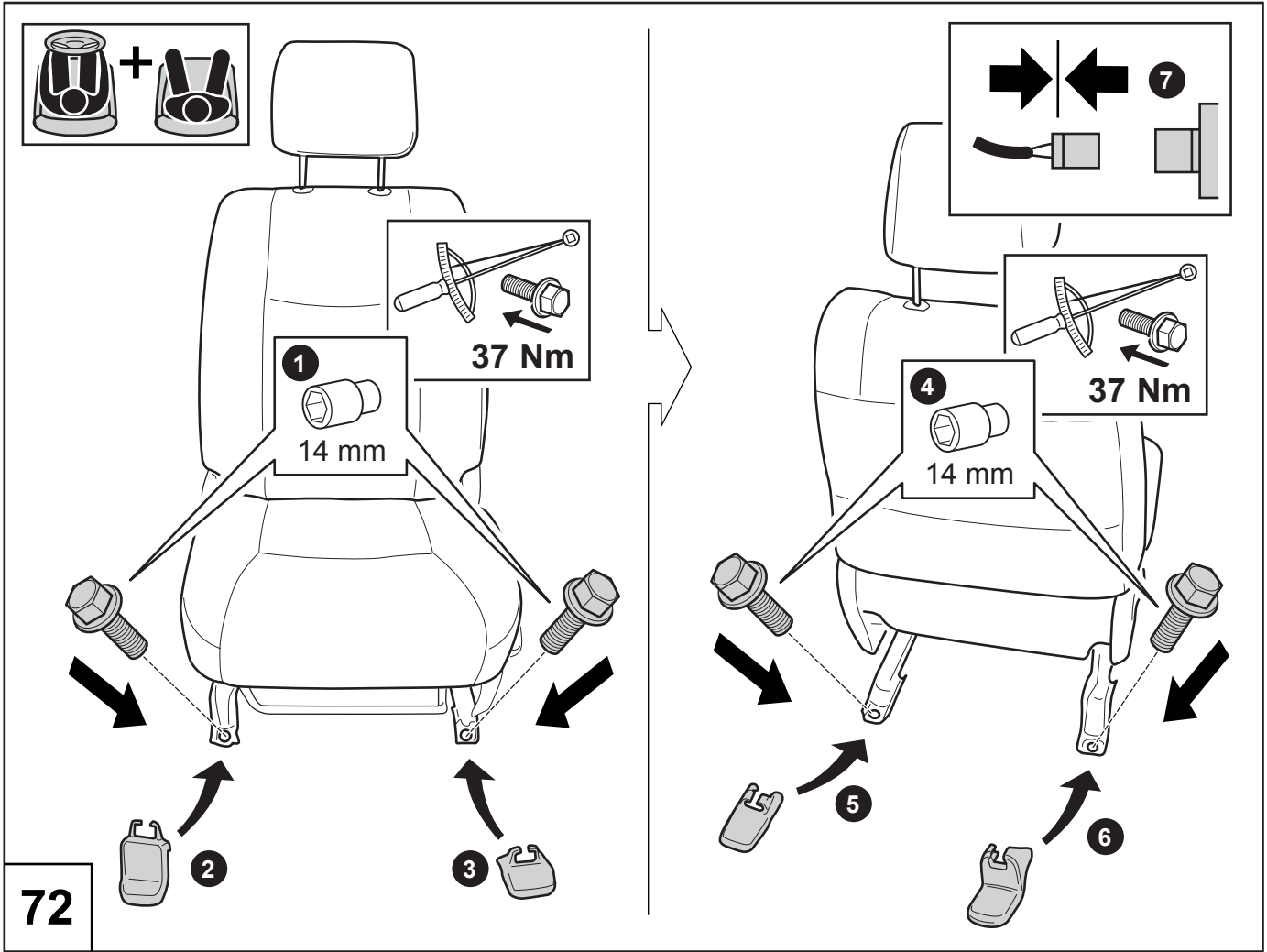

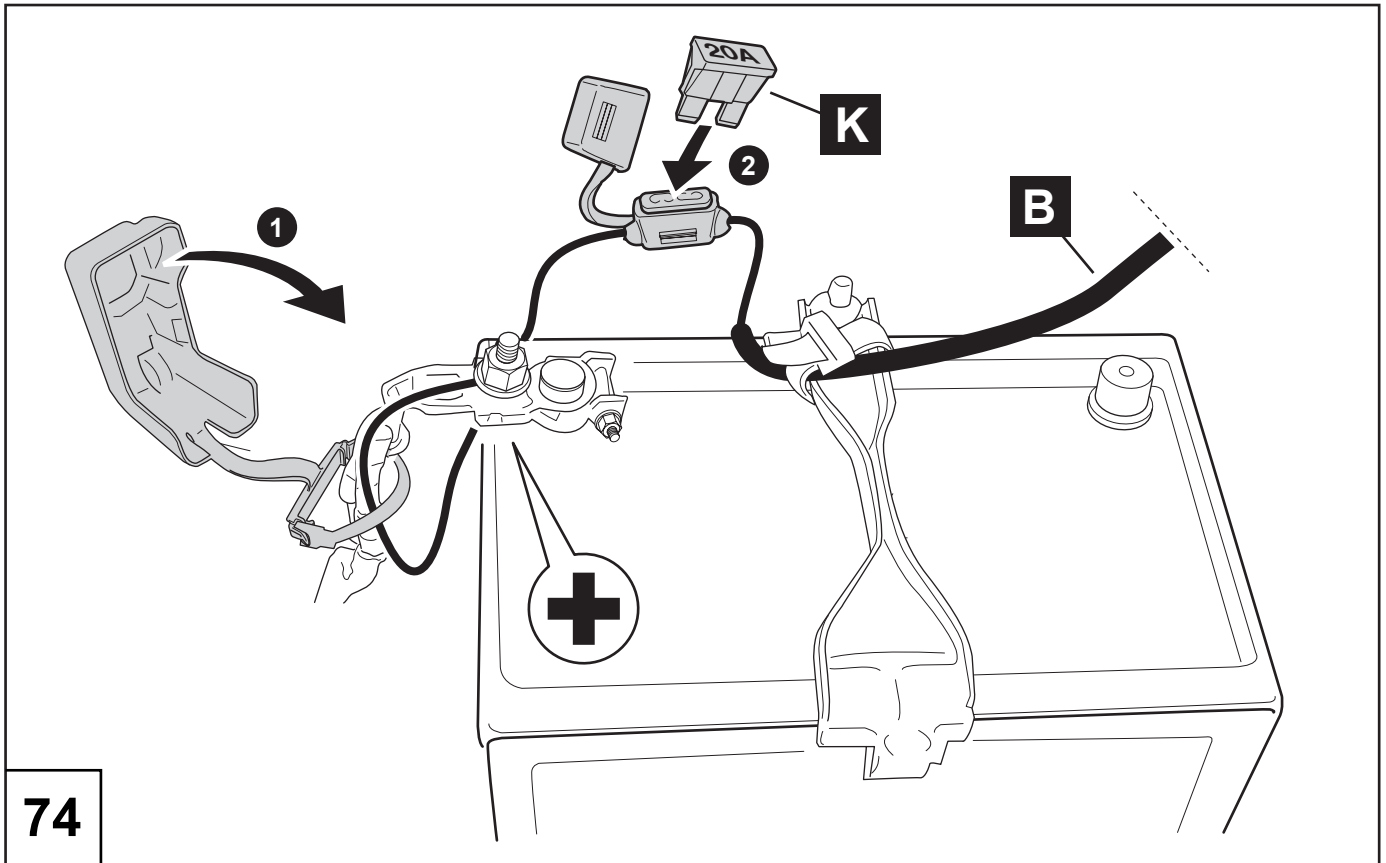

74

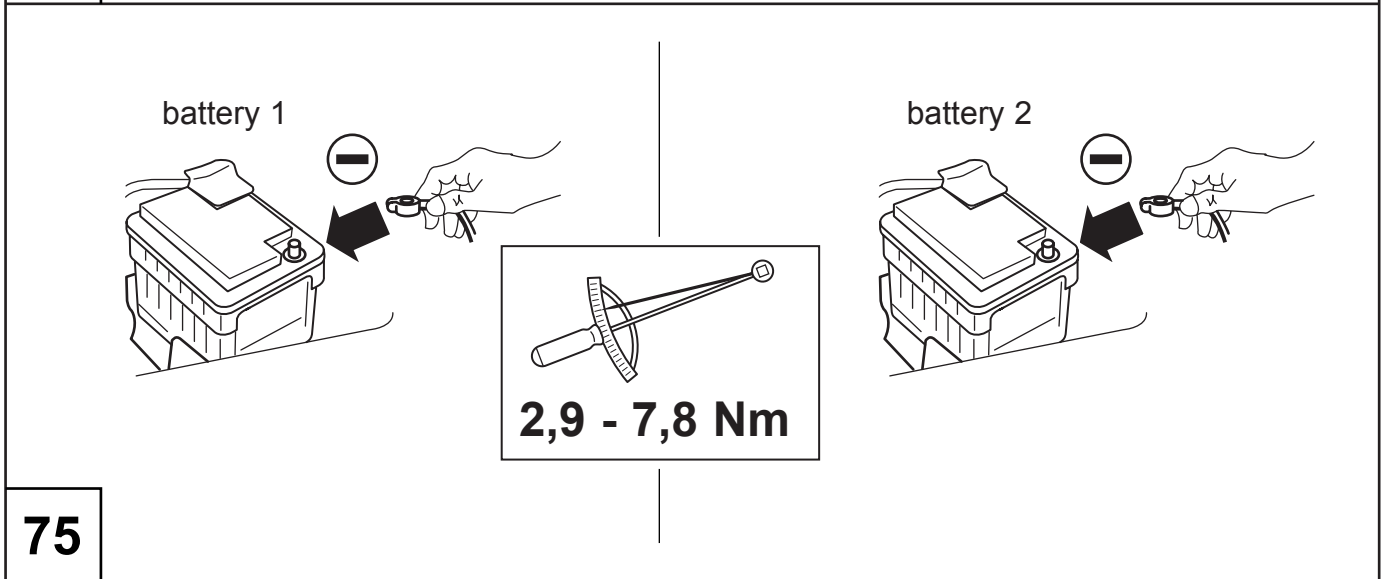

75

**CHECK FUNCTIONS !
 FUNKTIONEN KONTROLLIEREN !
 CONTRÔLER LES FONCTIONS !
 CONTROLEER FUNCTIES !**

76