

# TOYOTA HANDS FREE

## THF 15 / THF 25 / THF 35 INSTALLATION INSTRUCTIONS

### ***COROLLA*** **VERSO**

Model year: 2007

Vehicle Code: \*\*R1\*L-G\*\*\*W

Partnumber

Vehicle Kit	PZ456-E8294-00
Wire Harness Kit (normal)	PZ456-00296-00
Wire Harness Kit (TNS 600 & TNS 700)	PZ456-00297-00
Cupholder Console Kit	PZ402-00201-00



Vehicle Kit	0,15 kg
Wire Harness Kit	0,15 kg
Cupholder Console Kit	0,2 kg

## LHD

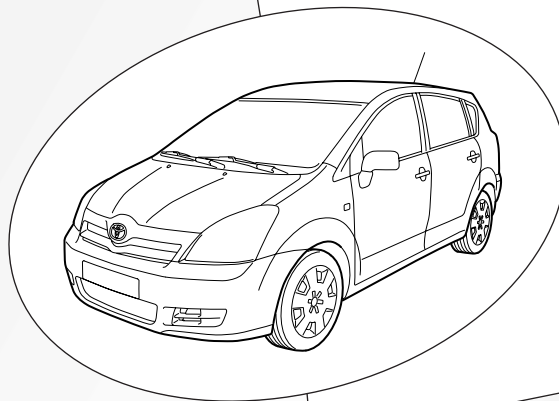

# Revision Record

Rev. No.	Date	Page	Picture	Update	New	Deleted Steps
2	12-04-07	1		X		
		2			X	
3	12-11-2007	9	12	X		
3	12-11-2007	9	13	X		
3	12-11-2007	9	14	X		
3	19-11-07	5	J,K	X		
3	19-11-07	6	J,K	X		

**GB**

- Expert Fitment Required.
- Disconnect the battery earth cable.
- To avoid damage to the wiring harness, ensure contact with sharp edges is prevented.
- Install parts as shown on illustrations.
- Re-connect battery.
- Re-fit panels, ensure that the wiring harness and other components are neatly and securely located.

**D**

- Montage durch Fachwerkstatt erforderlich.
- Massekabel von Batterie abklemmen.
- Zur Vermeidung von Beschädigungen an der Kabelisolation ist Berührung mit scharfen Kanten zu vermeiden.
- Teile gemäß Abbildung montieren.
- Batterie wieder anschließen.
- Paneele wieder anbringen; achten Sie darauf, daß der Kabelbaum und andere Teile ordnungsgemäß und genau positioniert sind.

**E**

- Montaje sólo por el concesionario.
- Desconectar el cable de masa de la batería.
- A efectos de evitar desperfectos en el aislamiento del cable, hay que evitar el contacto con aristas cortantes.
- Montar las piezas tal como se indica en las figuras.
- Vuelva a conectar la batería.
- Volver a colocar los paneles; preste atención a que el mazo del cable y las demás piezas tengan la posición correcta y precisa.

**F**

- Montage par spécialiste nécessaire.
- Débrancher le câble de masse de la batterie.
- Eviter tout contact avec des arêtes vives afin de ne pas endommager l'isolation des câbles.
- Monter les pièces selon les figures.
- Reconnecter la batterie.
- Remettre le panneau; veillez à ce que le faisceau et les autres pièces soient positionnés correctement et avec la précision requise.

**I**

- E' necessario in officina specializzata.
- Staccare il cavo di massa dalla batteria
- Allo scopo di evitare danni all'isolazione dei cavi, evitare di metterli a contatto con spigoli acuti.
- Montare le parti secondo quanto rilevabile delle illustrazioni.
- Riconnettere la batteria.
- Rimettere in posizione i pannelli; far ben attenzione che il fascio di cavi e le altre parti siano state posizionate con esattezza e nella dovuta maniera.

**P**

- Especialista em montagem requerido.
- Separe o cabo de terra do acumulador.
- Para não se danificar a isolação dos cabos, é conveniente evitar-se contacto com arestas afiadas.
- Monte as partes conforme ilustrado.
- Recolocar a bateria
- Tornar a colocar os painéis; verificar se a árvore de cabos e outras peças estão na posição exacta e prescrita.

**NL**

- Montage door vakman nodig.
- Massakabel van accu losmaken.
- Ter vermindering van beschadiging aan de isolatie van de elektrokit dient contact met scherpe kanten te worden vermeden.
- Delen overeenkomstig afbeelding monteren.
- Accu weer aansluiten.
- Panelen weer monteren; let erop, dat de kabelboom en andere delen correct en netjes gepositioneerd worden.

**DK**

- Montage ved professionelt værksted påkrævet.
- Stelkabel fjernes fra batteri.
- Berøring med skarpe kanter skal undgås for at undgå beskadigelse af kabelisoleringen.
- Dele skal monteres i henhold til illustrationer.
- Tilslut batteri igen.
- Paneler fastgøres igen; vær opmærksom på, at kabelsamlingen og andre dele placeres korrekt og præcist.

**N**

- Nødvendig med montering fra fagvegverksted.
- Klem jordkabelen av batteriet.
- For å unngå skader på kabelisoleringen må berøring av skarpe kanter unngås.
- Monter alle deler i henhold til illustrasjonene.
- Tilkobl batteriet igjen.
- Monter panelene igjen, og pass på at kabelbunten og andre deler er anbrakt ordentlig og på riktig sted.

**S**

- Verkstadsmontage erfordras.
- Lossa stomkabeln från batteriet.
- För att förhindra skador på ledningarnas isolation skall berøring med vassa kanter undvikas.
- Montera detaljerna enligt figurerna
- Anslut batteriet igen.
- Sätt tillbaka panelerna igen; kontrollera noga att ledningsmattan och andra detaljer ligger på rätt plats.

**FIN**

- Asennus tarpeen merkkikorjaamossa.
- Erotta maadoitusjohto akusta
- Pidä huoli myös siitä, että kaapelointi on korin kiinnityksen myötäinen ja kiinnitetty huolellisesti muihin liikkuviin osiin.
- Asenna osat kuvien mukaan.
- Kytke akku takaisin.
- Aseta paneelit paikalleen; tarkista, että kaapelointi ja muut osat ovat asianmukaisesti ja tarkalleen paikoillaan.

**CZ**

- Montáž ve specializované dílně nutná.
- Odpojte zemnicí kabel od baterie.
- Zabraňte tomu, aby se kabely poškodily tím, že jsou položeny na ostrých hranách.
- Montujte části podle vyobrazení
- Opět připojit baterii.
- Opět připevněte panely; dbejte na to, aby svazek kabelů a ostatní části byly uloženy na správném místě.

**H**

- A szereléshez szakműhely kell.
- Húzza le az akkumulátor testkábeljét.
- A kábelszigetelés megsérülésének elkerülésére ügyeljen arra, hogy a kábel ne juthasson érintkezésbe éles peremű alkatrészekkel.
- Az alkatrészeket az ábrák szerint szerelje be.
- Ismét csatlakoztassa az akkumulátort.
- Szerelje vissza a fedőlapokat, ügyeljen arra, hogy a kábelek és a többi alkatrészek pontosan a számkra kijelölt helyen maradjanak.

**PL**

- Konieczny montaż przez warsztat specjalistyczny.
- Odłączyć przewód masy od akumulatora.
- Dla zapobieżenia uszkodzeniu izolacji chronić przed zetknięciem z ostrymi krawędziami.
- Zamontować części zgodnie z rysunkiem.
- Ponownie podłączyć akumulator.
- Na powrót osadzić osłony; zadbać aby wiązka kablowa i inne części były właściwie i dokładnie ułożone.

**GR**



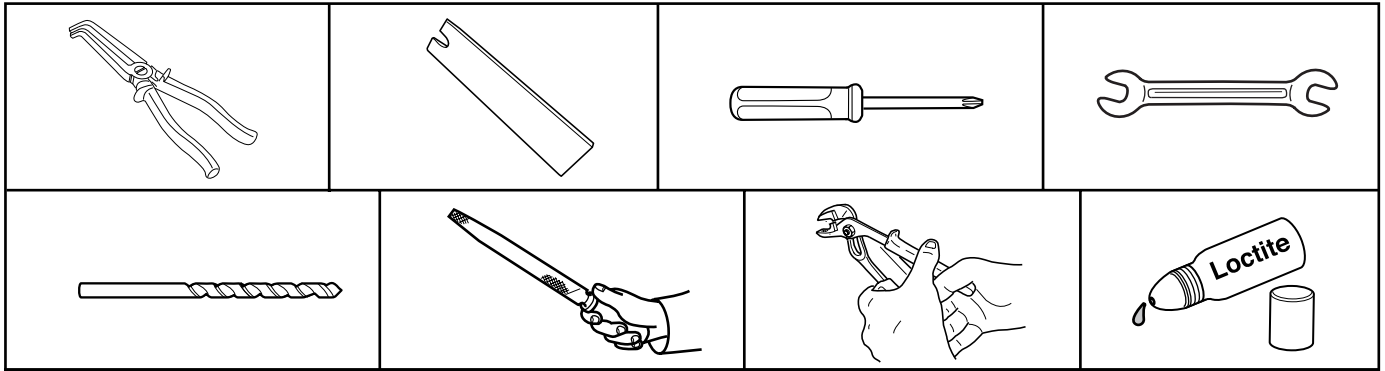



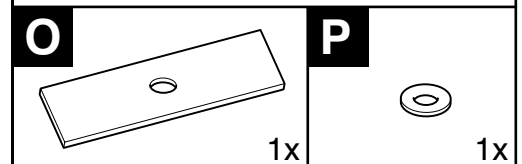
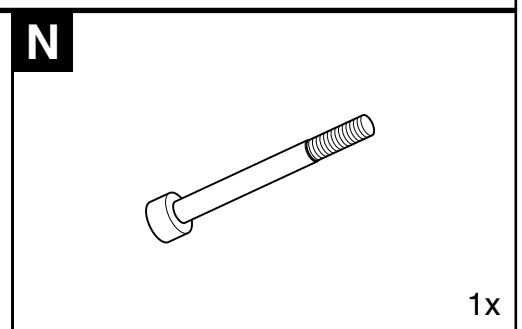
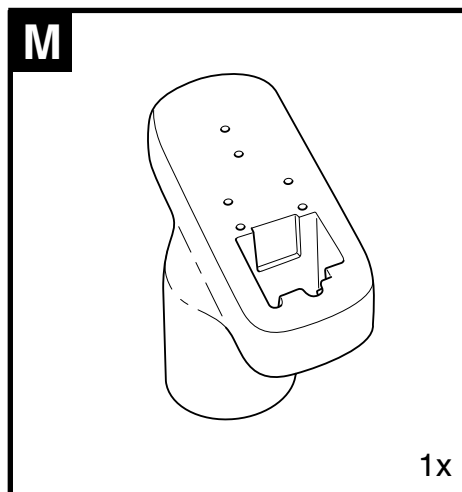
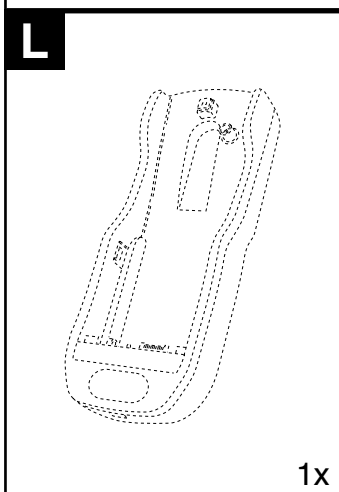
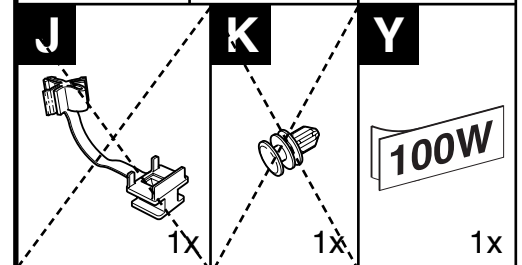
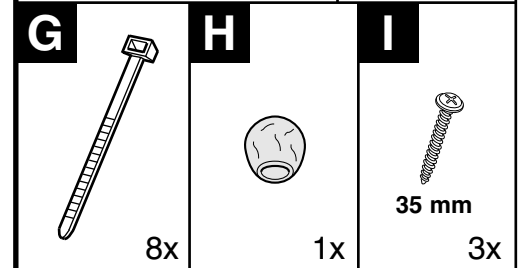
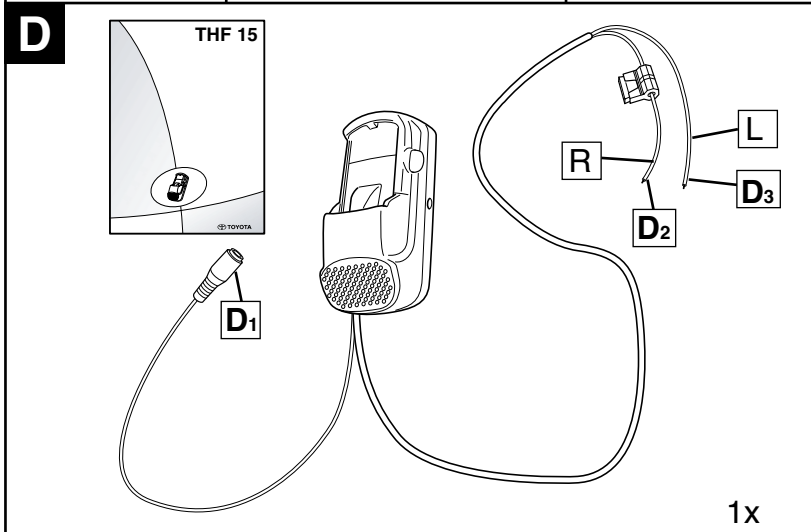
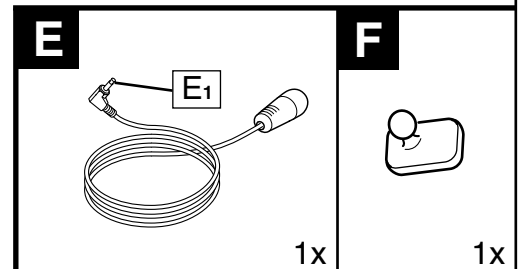
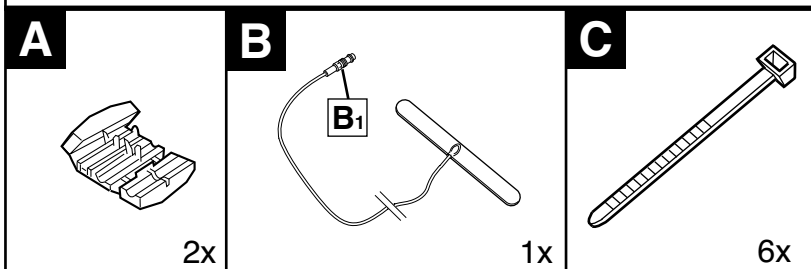

- Να τοποθετεί από συνεργείο.
- Αποσυνδέστε το καλώδιο γείωσης από τη μπαταρία.
- Για να αποφευχθούν ζημιές στη μόνωση καλωδίων, να αποφεύγεται η επαφή των με αιχμηρές ακμές.
- Τοποθέτηση των μερών σύμφωνα με τις Εικόνες.
- Συνδέστε πάλι τη μπαταρία.
- Τοποθετήστε πάλι το κάλυμμα προσοχή, η πλεξούδα καλωδίων και άλλα μέρη να είναι τοποθετημένα ακριβώς και σύμφωνα με τους κανονισμούς.

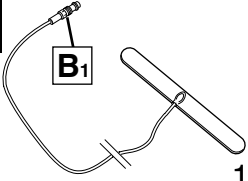
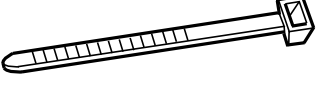
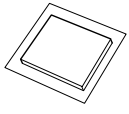
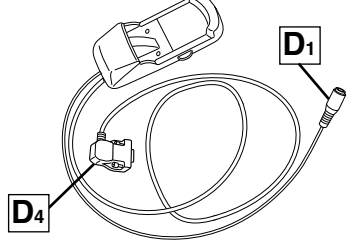
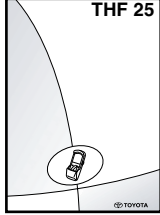
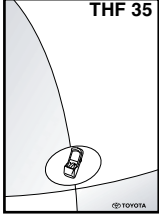
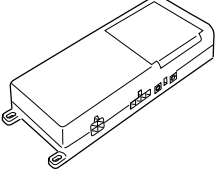
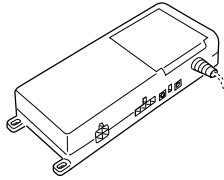
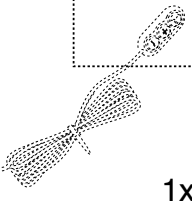
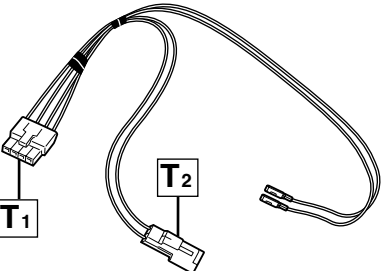
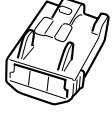

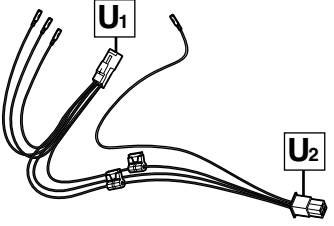
**THF 15**

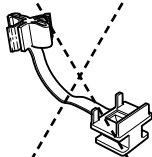

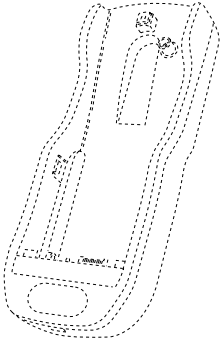
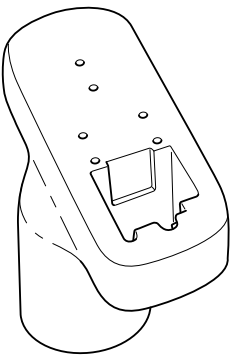
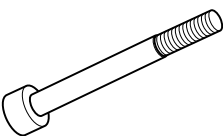
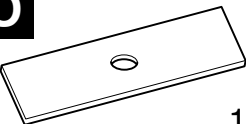
# THF 25 / THF 35

<b>Q</b>  1x	<b>B</b>  1x	<b>C</b>  6x	<b>R</b>  2x
<b>D</b>  THF 25 THF 35   1x	<b>S</b> THF 25 THF 35   Voice Dial  1x		
<b>T</b>  1x		<b>V</b>  1x	<b>H</b>  1x <b>I</b>  25 mm 3x
<b>U</b>  1x	<b>W</b>  1x	<b>J</b>  1x <b>K</b>  1x	
<b>L</b>  1x	<b>M</b>  1x	<b>N</b>  1x	
<b>O</b>  1x		<b>P</b>  1x	

	GB	D	E	F	I	P	NL	DK
L	Blue	Blau	Azul	Bleu	Blu	Azul	Blauw	Blå
B	Black	Schwarz	Negro	Noir	Nero	Preto	Zwart	Sort
BR	Brown	Braun	Marrón	Marron	Marrone	Castanho	Bruin	Brun
G	Green	Grün	Verde	Vert	Verde	Verde	Groen	Grøn
GR	Grey	Grau	Gris	Gris	Grigio	Cinzeno	Grijs	Grå
NO	Natural colour	Naturfarben	Color natural	Nature	Colori naturali	Cores naturais	Naturel	Naturfarvet
O	Orange	Orange	Naranja	Orange	Arancione	Laranja	Oranje	Orange
P	Pink	Rosa	Rosa	Rose	Rosa	Rosa	Rosé	Rosa
R	Red	Rot	Rojo	Rouge	Rosso	Vermelho	Rood	Rød
W	White	Weiß	Blanco	Blanc	Bianco	Branco	Wit	Hvid
Y	Yellow	Gelb	Amarillo	Jaune	Giallo	Amarelo	Geel	Gul
V	Violet	Violett	Violeta	Violet	Viola	Violeta	Violet	Violet

	N	S	SF	CZ	H	PL	GR
L	Blå	Blå	Sininen	Modrá	Kék	Niebieska	Μπλε
B	Sort	Svart	Musta	Černá	Fekete	Czarna	Μαύρο
BR	Brun	Brun	Ruskea	Hnědá	Barna	Brazowa	Καφέ
G	Grønn	Grön	Vihreä	Zelená	Zöld	Zielona	Πράσινο
GR	Grå	Grå	Harmaa	Šedá	Szürke	Szara	Γκρι
NO	Naturfarger	Naturfärger	Luonnonväri	Přírodní barva	Természetes színű	Barwy naturalne	Φυσικά χρώματα
O	Orange	Orange	Oranssi	Oranžová	Narancs	Pomarańczowa	Πορτοκαλί
P	Rosa	Rosa	Rosa	Růžová	Rózsaszín	Różowa	Ροζ
R	Rød	Röd	Punainen	Červená	Piros	Czerwona	Κόκκινο
W	Hvit	Vit	Valkoinen	Bílá	Fehér	Biała	Λευκό
Y	Gul	Gul	Keltainen	Žlutá	Sárga	Żółta	Κίτρινο
V	Fiolett	Violett	Violetti	Fialová	Ibolyakék	Fioletowa	Μοβ



**THF 15**

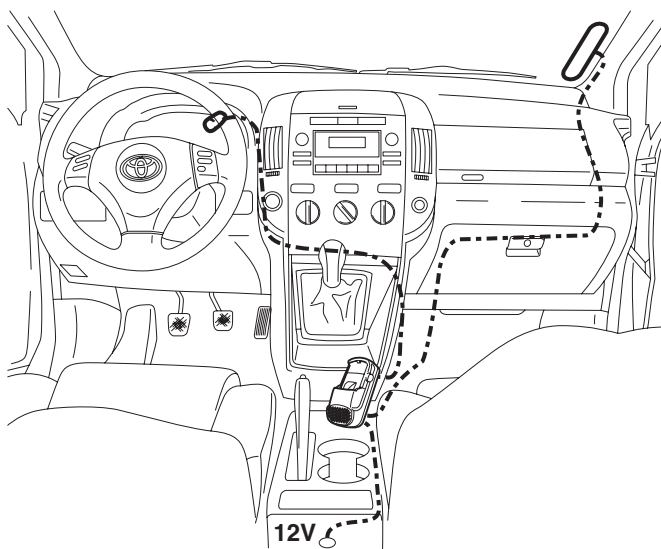

**THF 25 / THF 35**

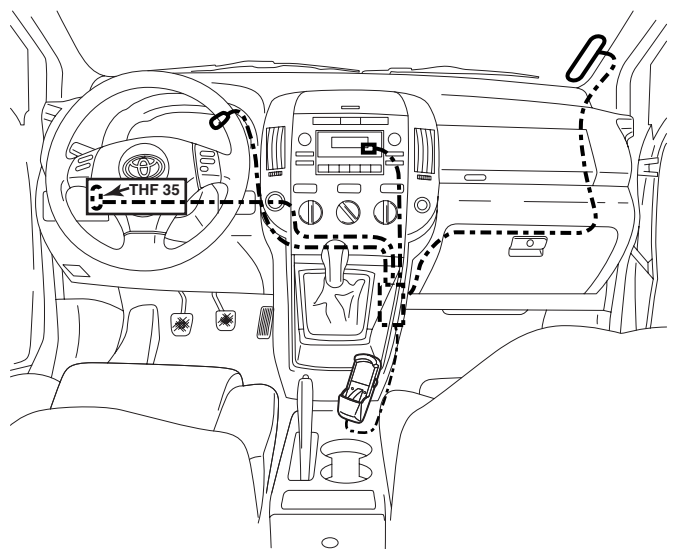

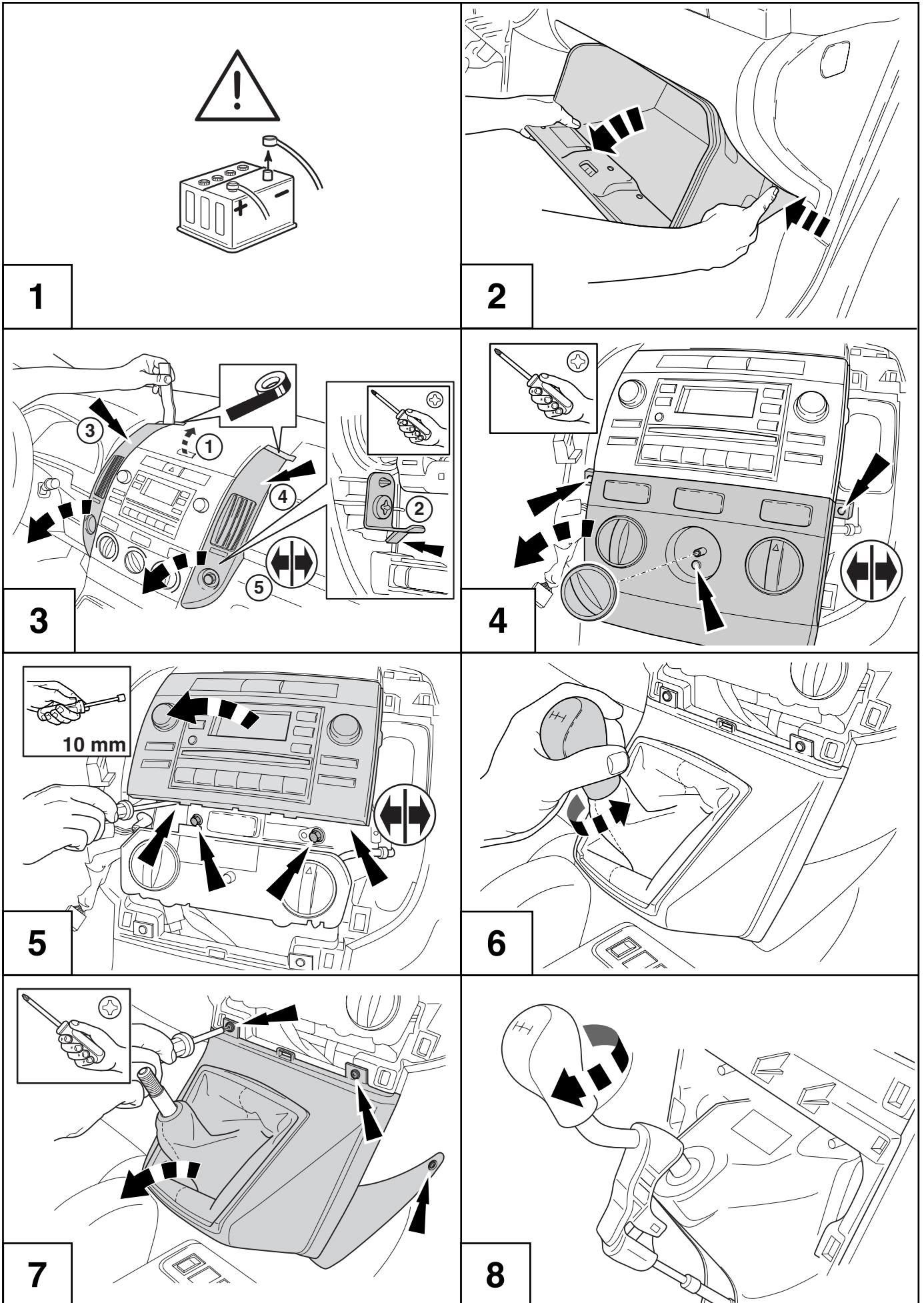



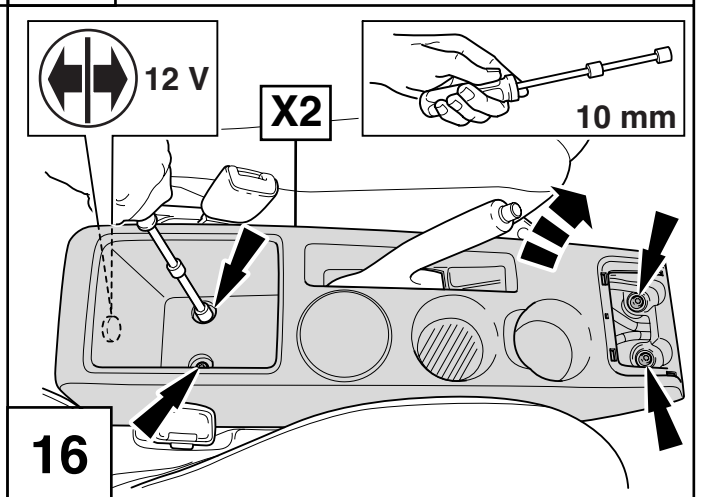
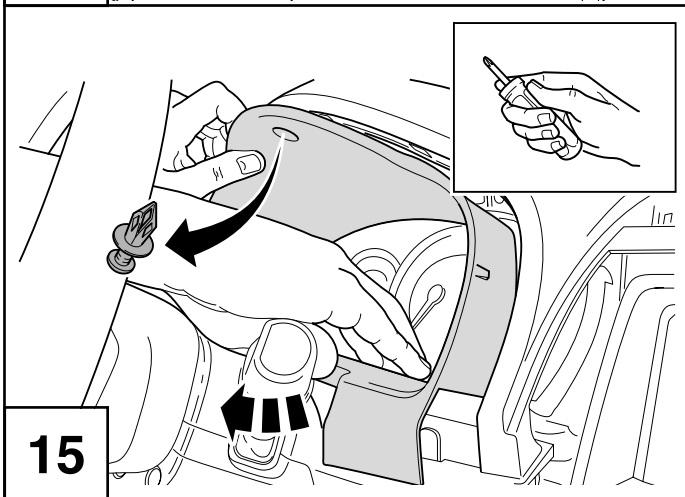
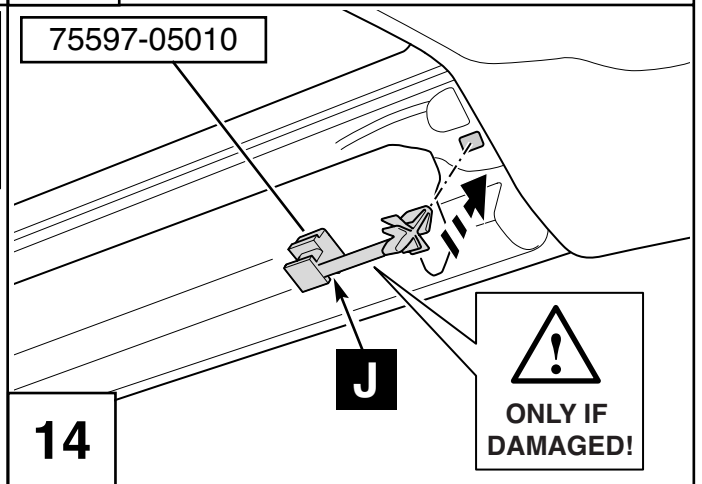
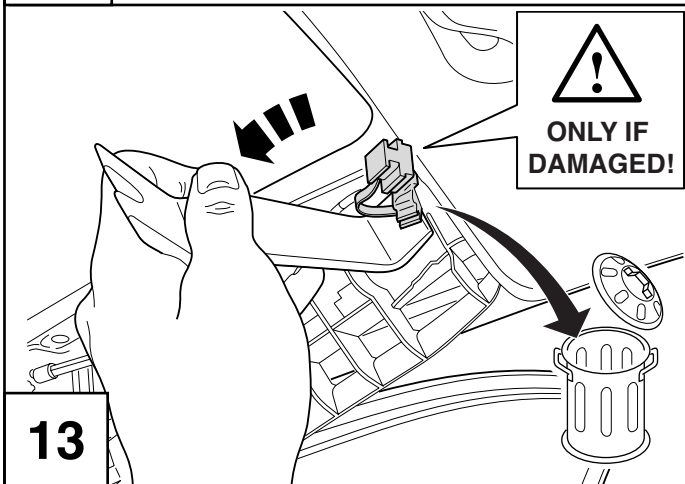
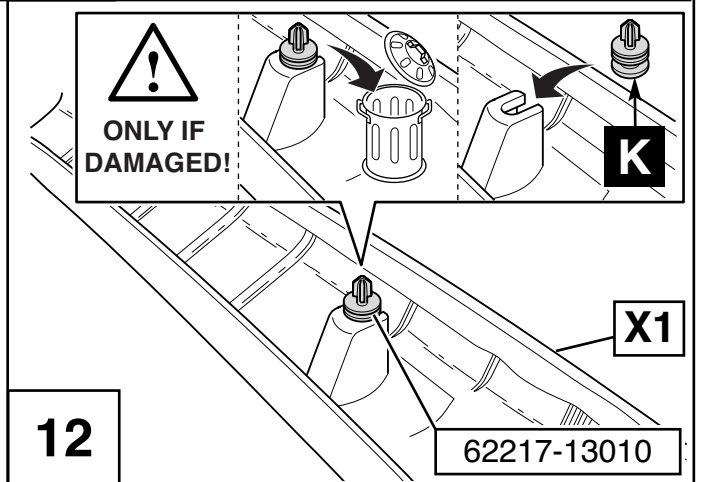
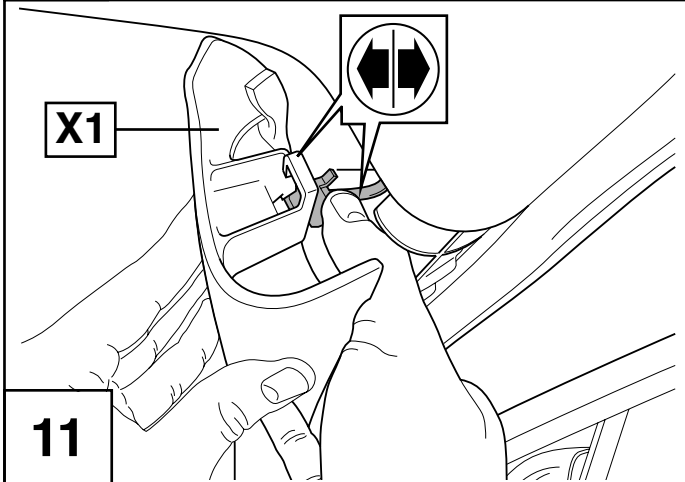
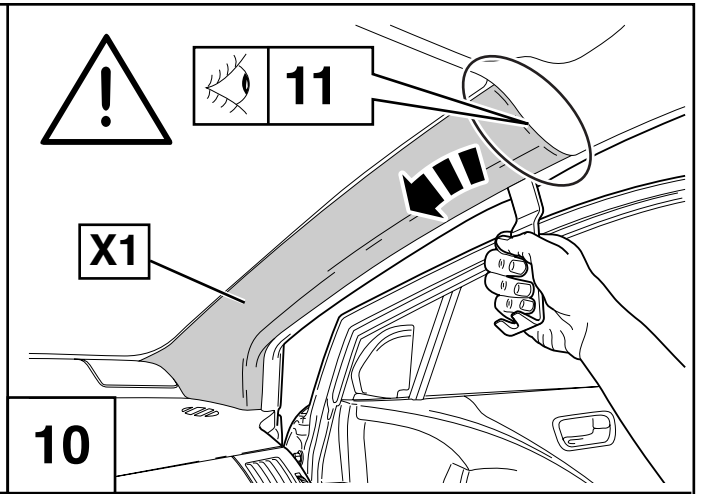
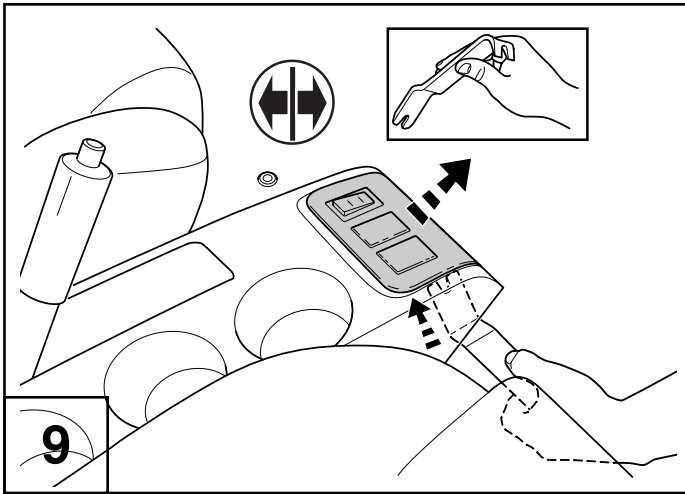

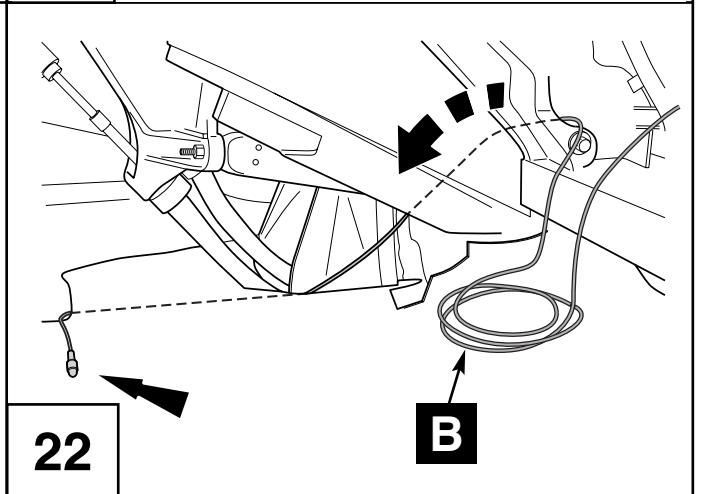
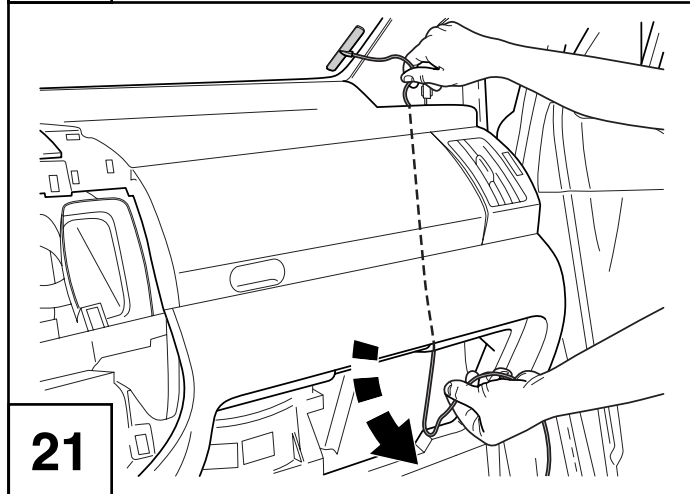
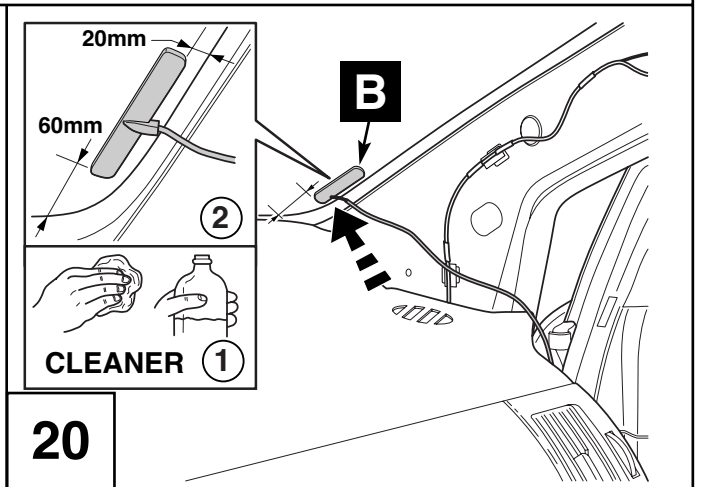
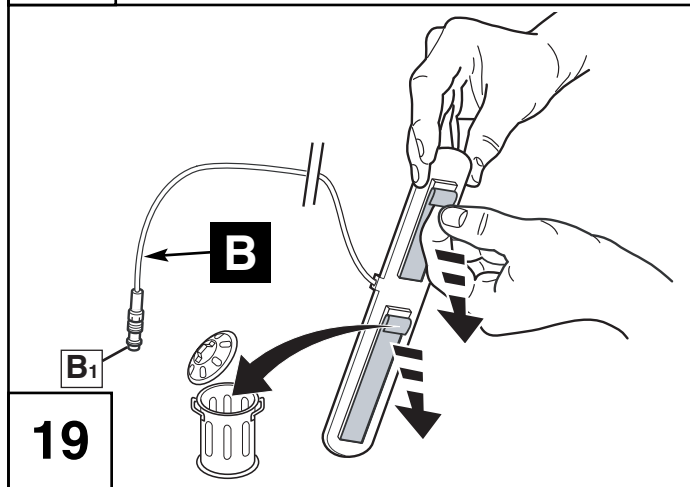
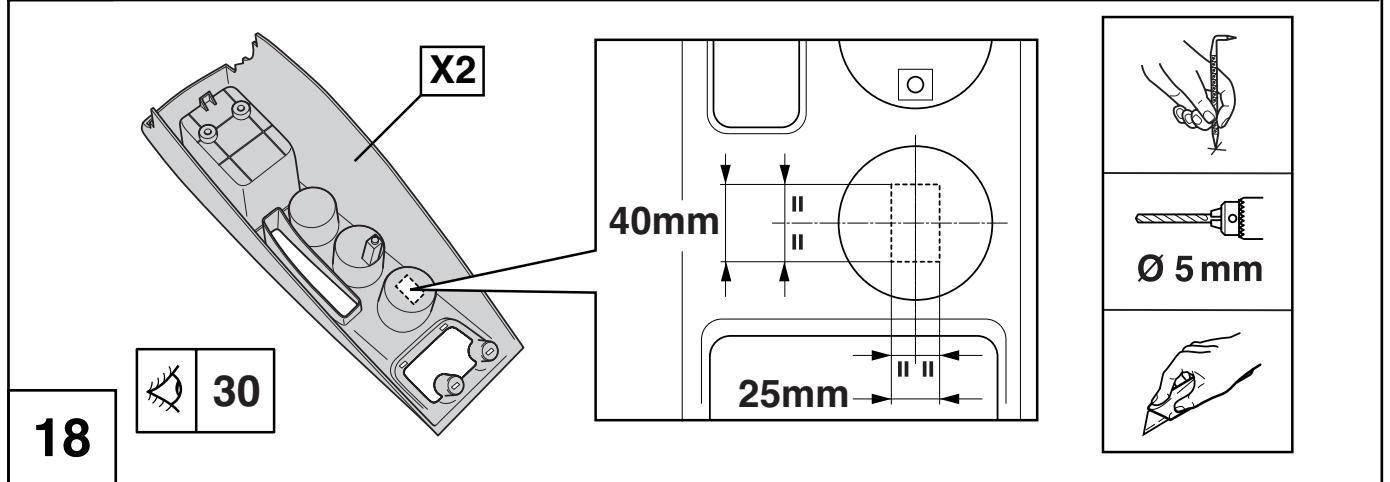
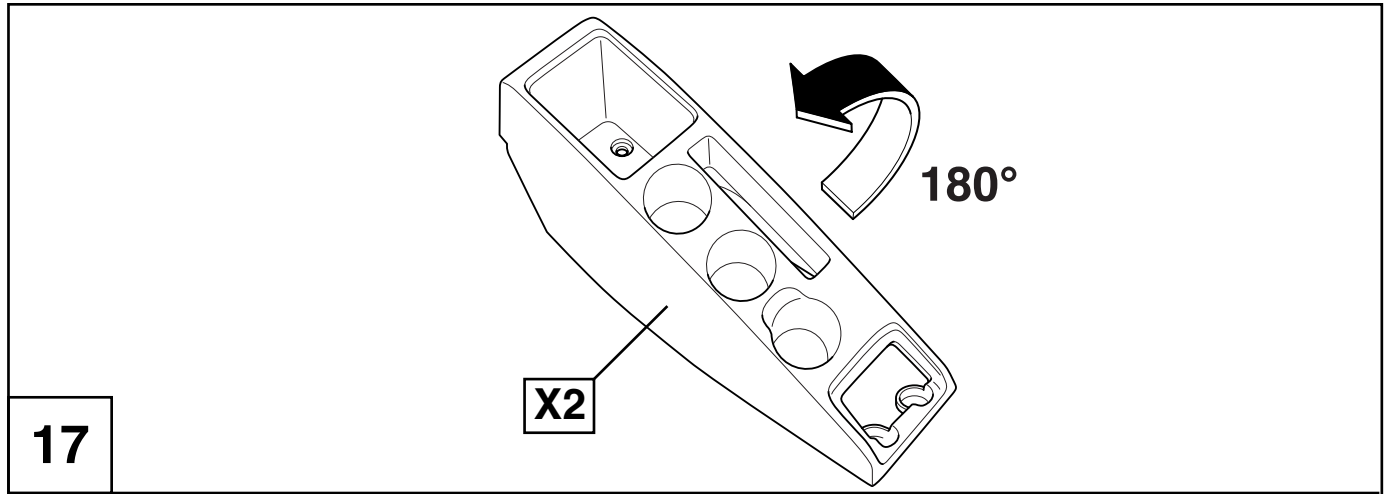

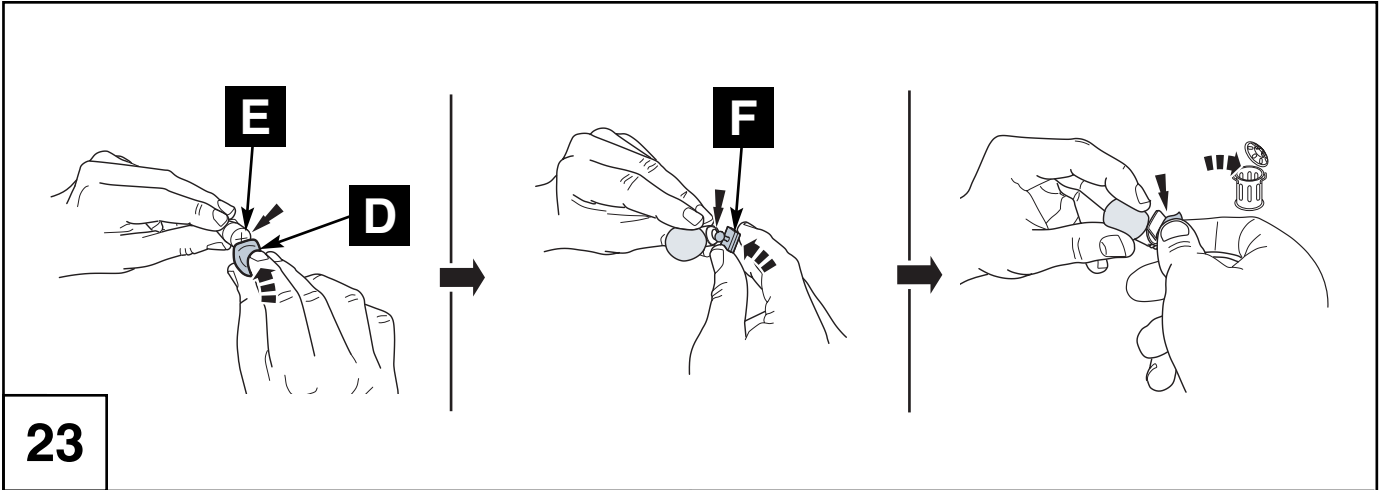

23

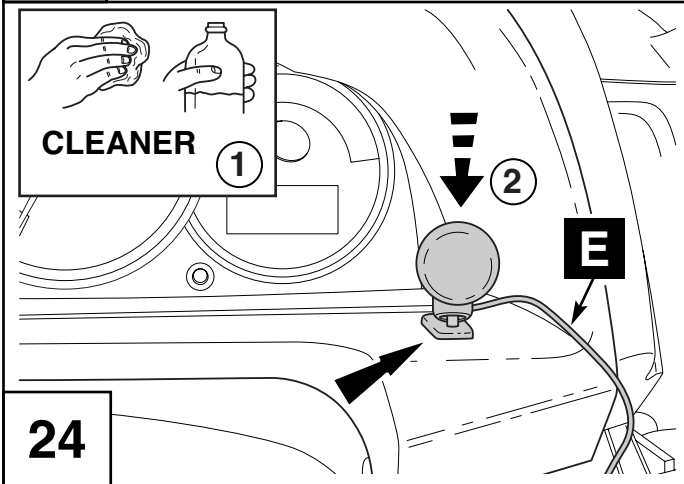

24

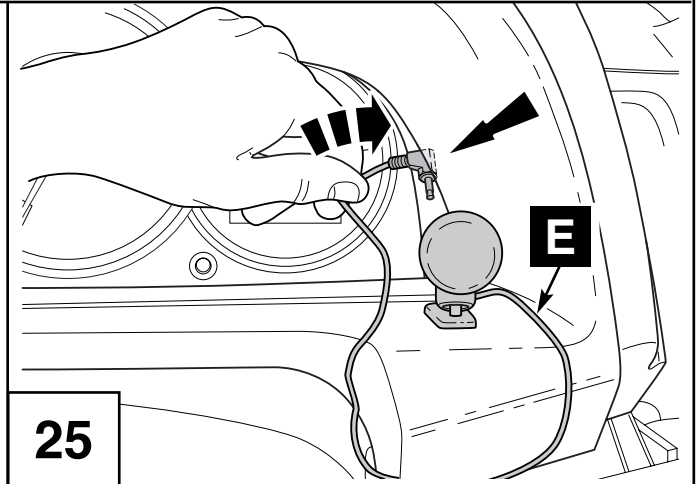

26

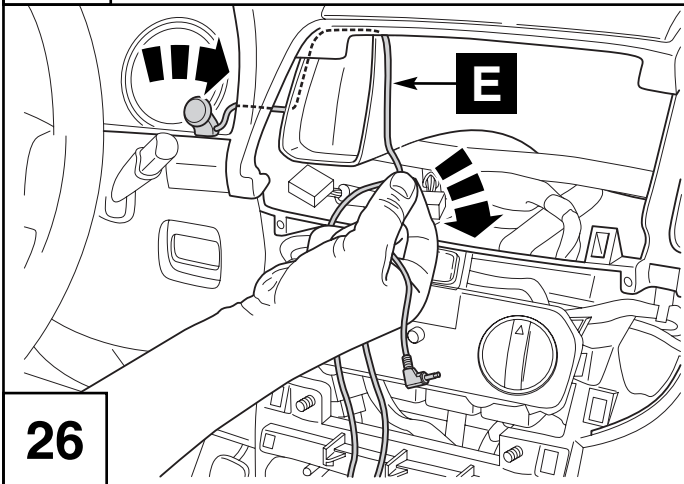

27

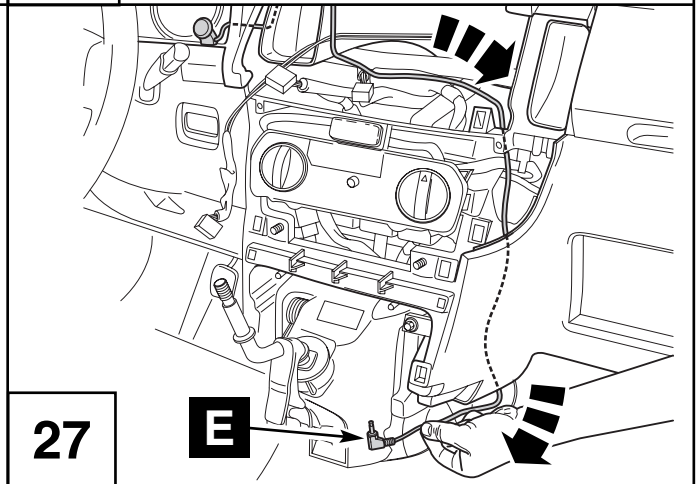

28

THF 15

29-41

---

THF 25 / THF 35

42 →

28

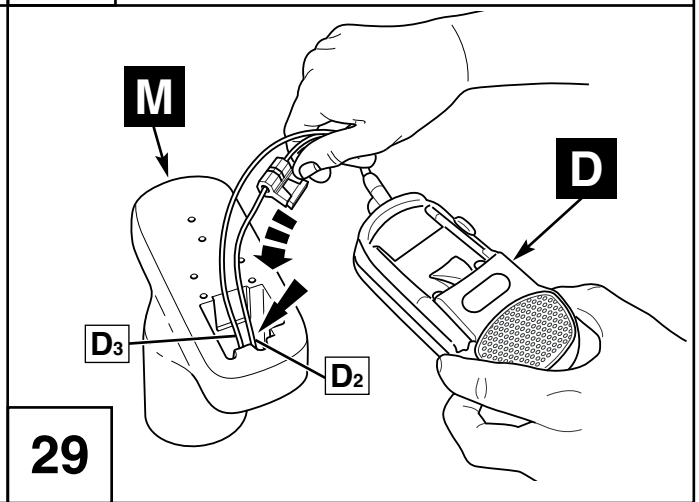

29

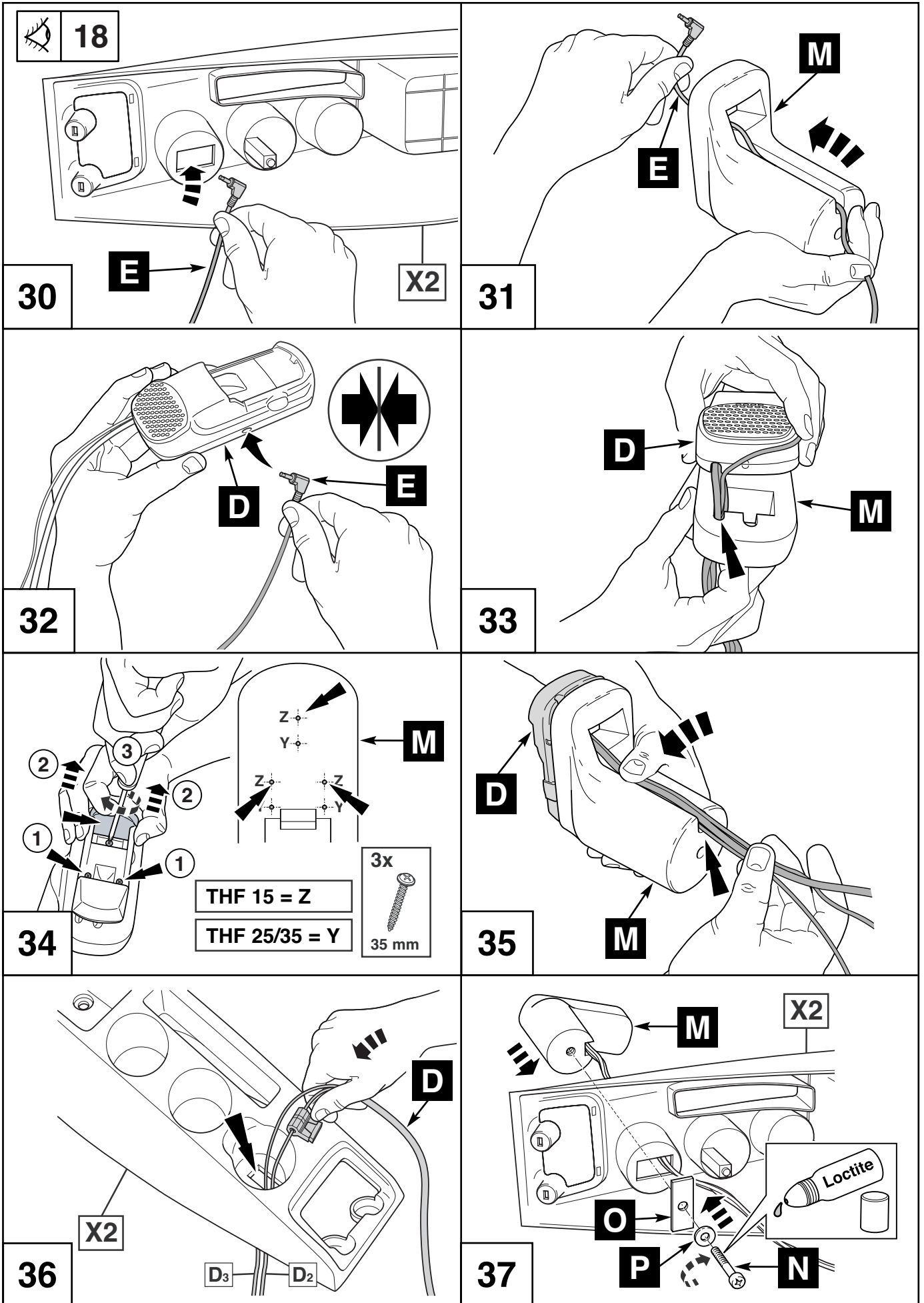

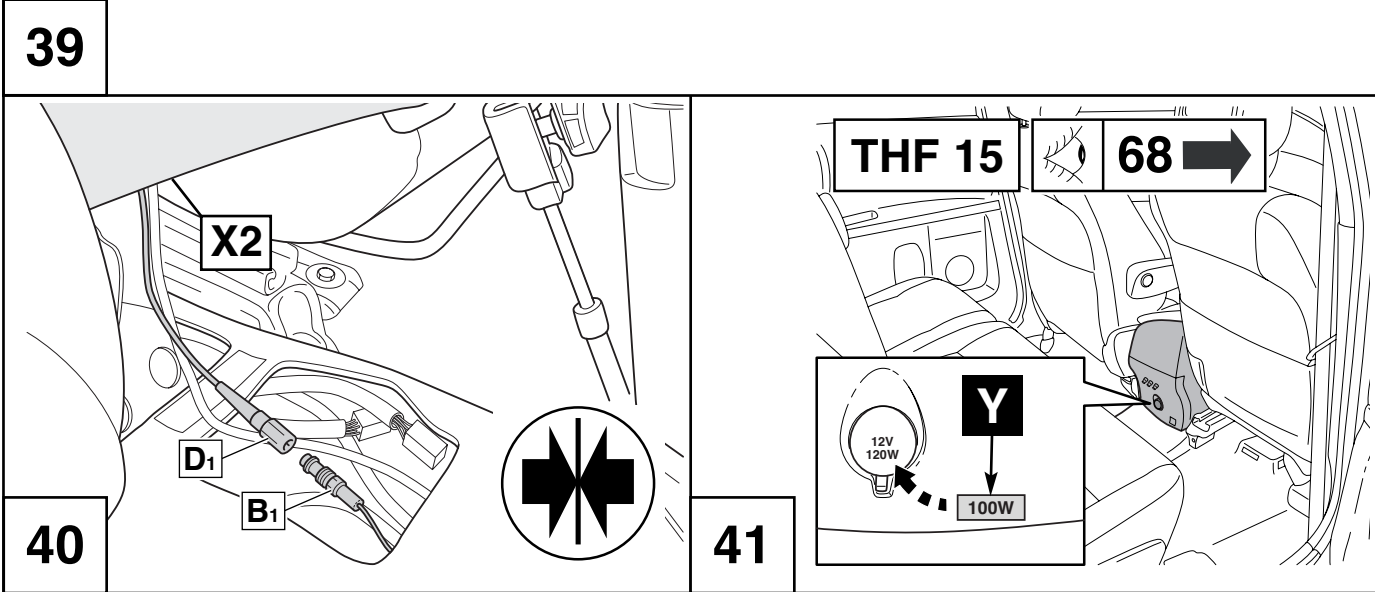
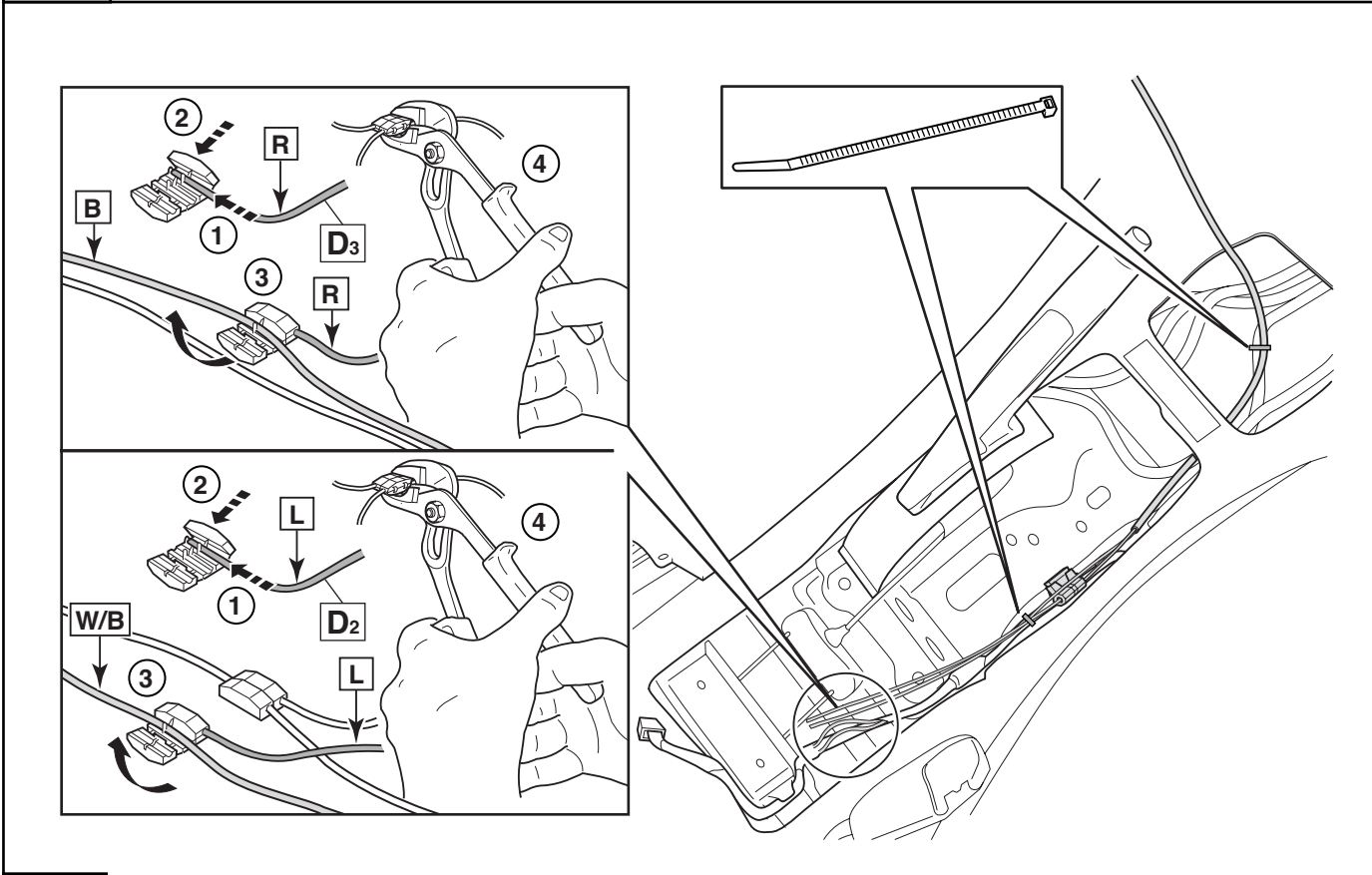
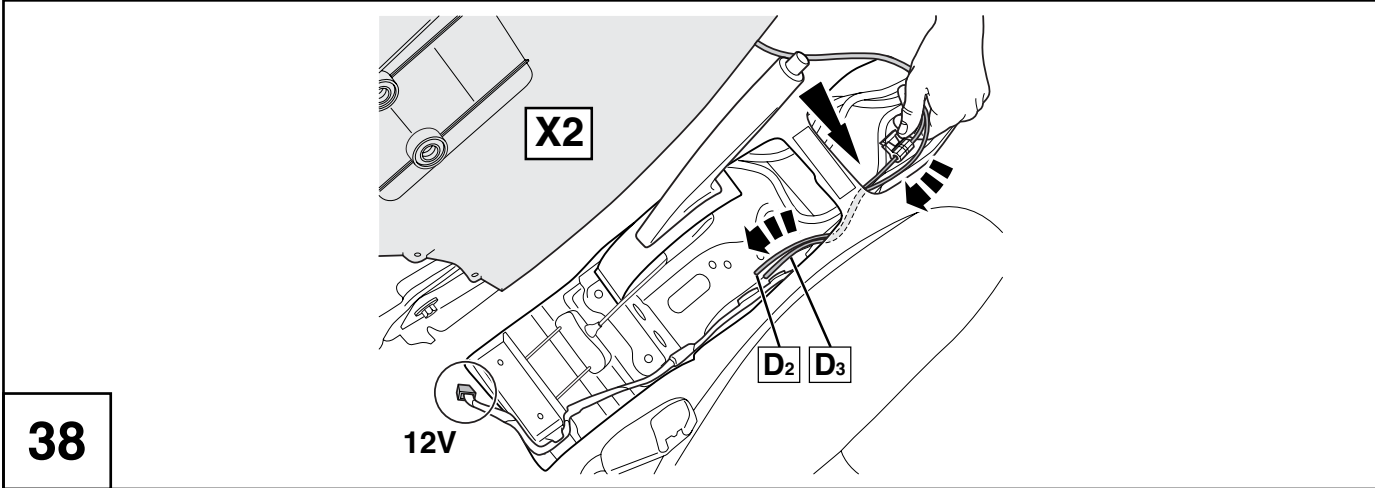

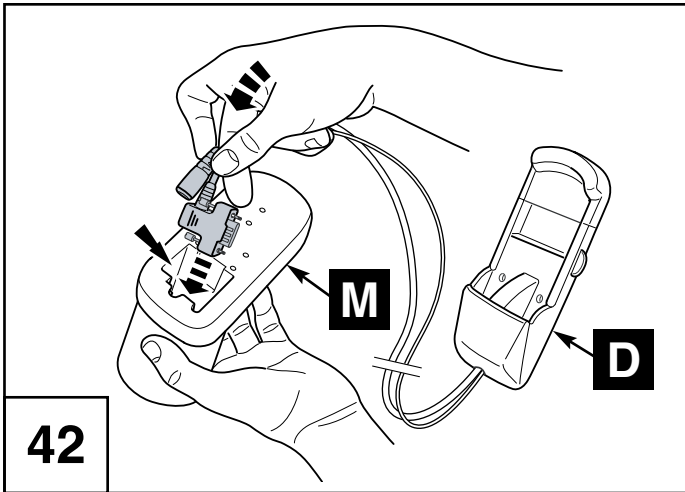

42

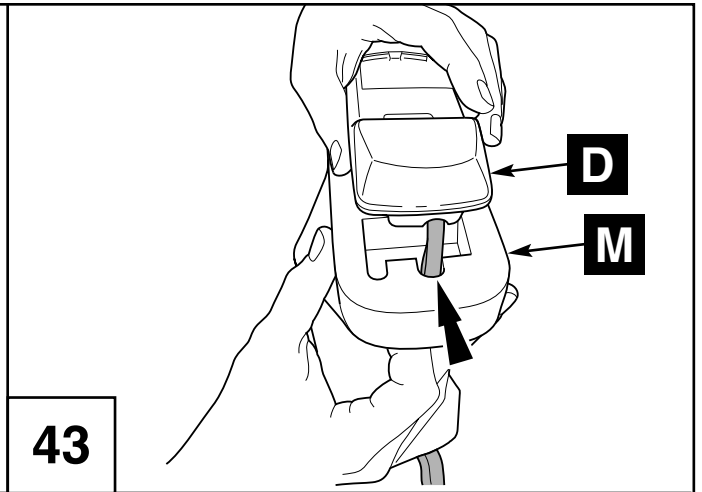

43

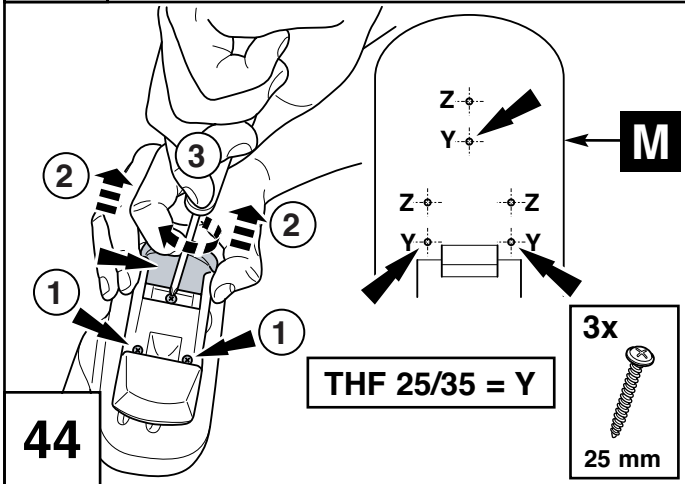

44

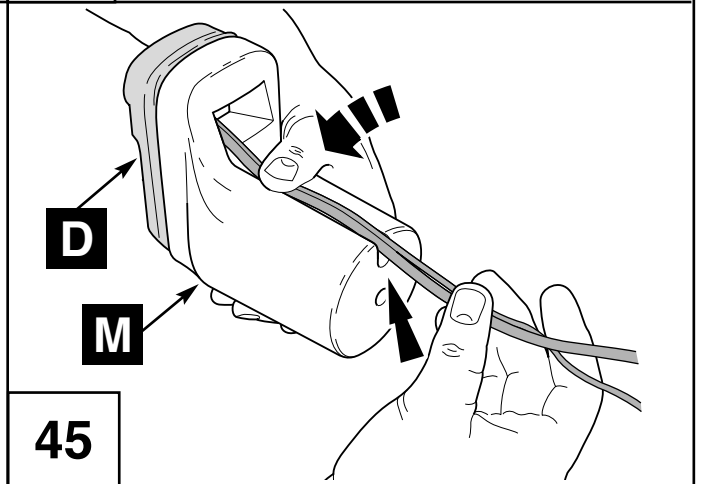

45

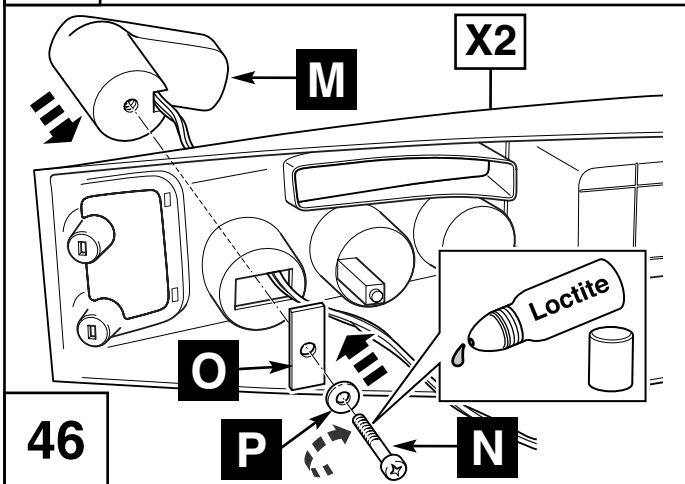

46

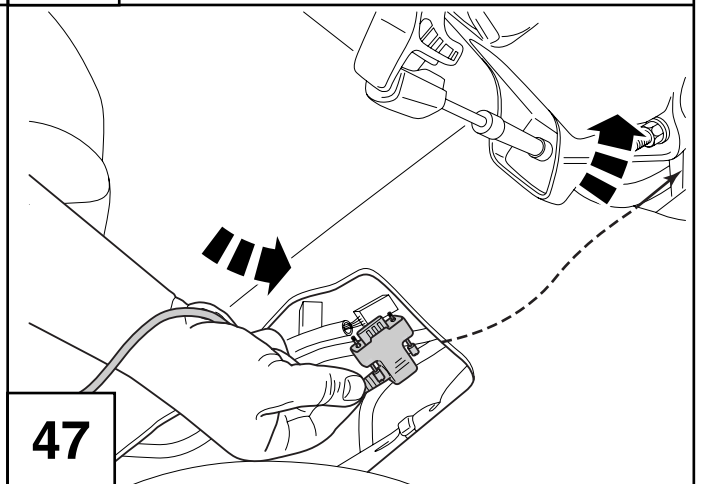

47

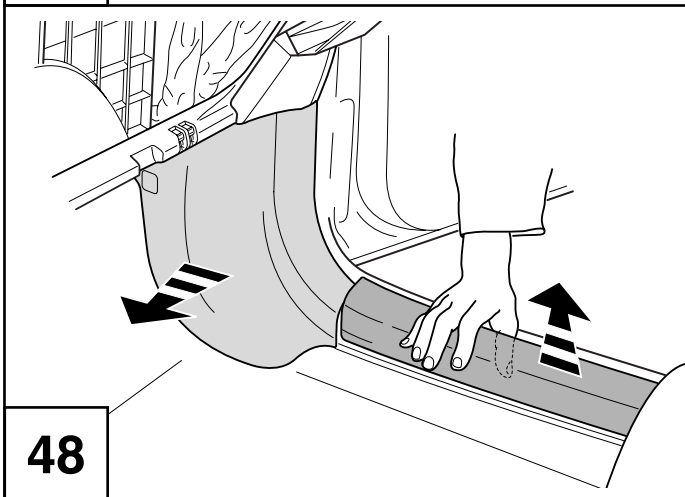

48

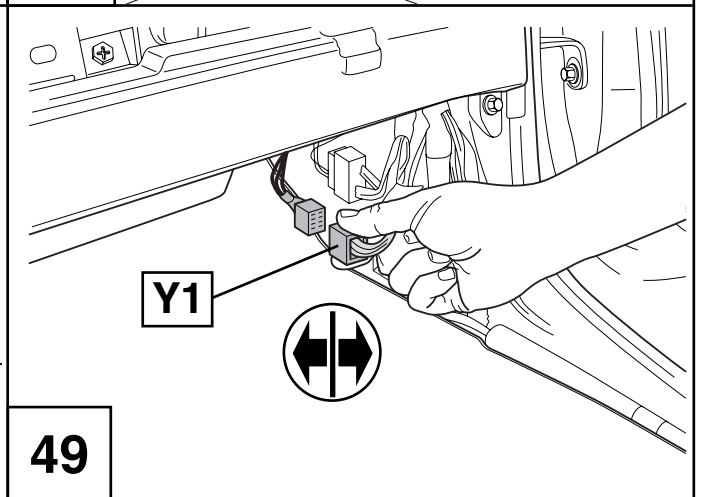

49

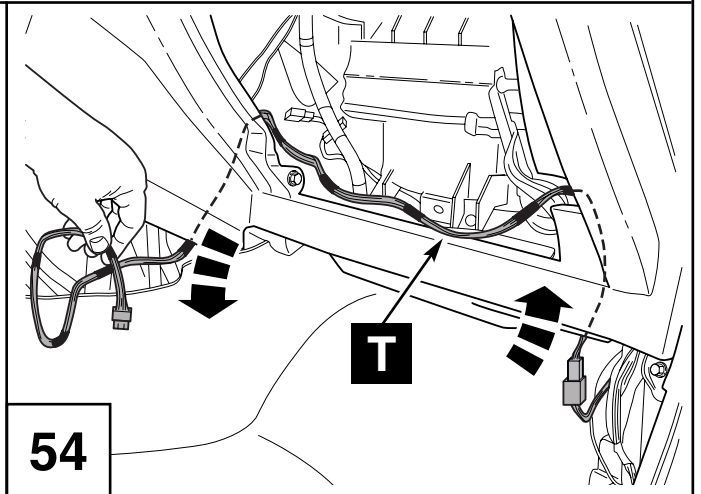
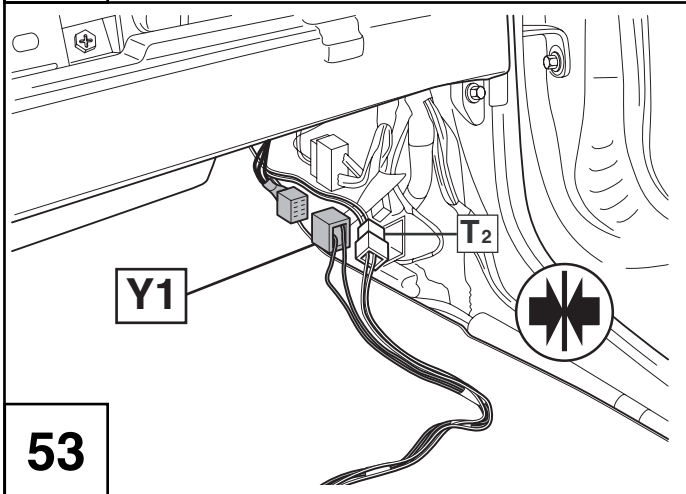
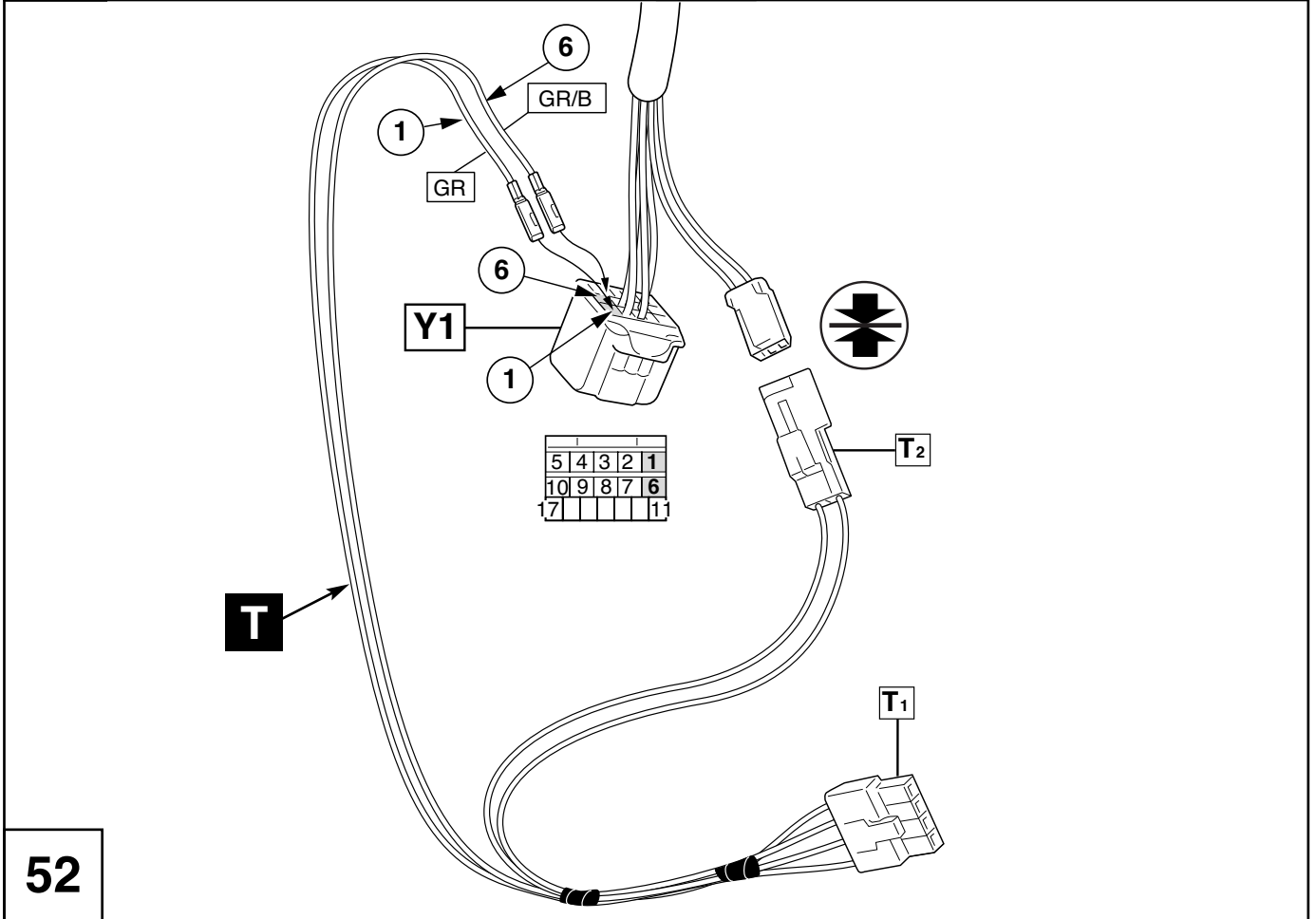
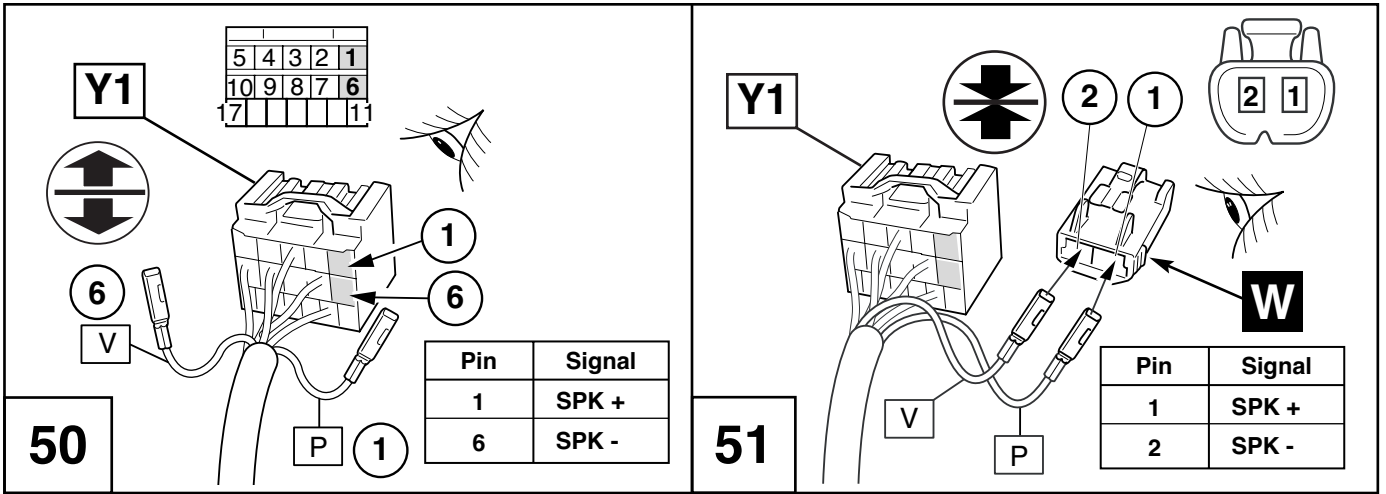

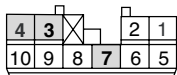
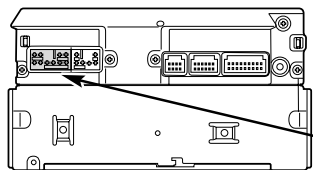

Pin	Signal
4	B+
3	ACC
7	GND

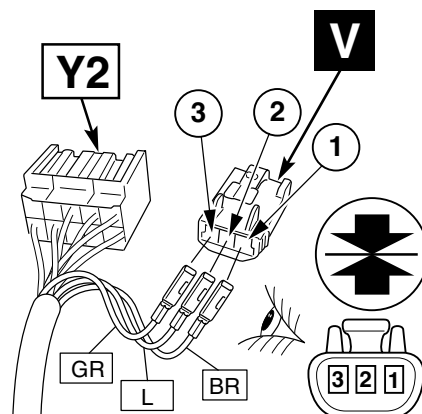
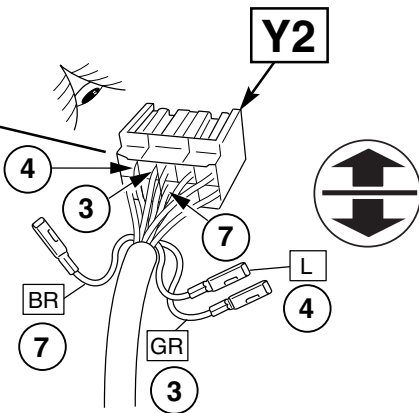

Pin	Signal
1	GND
2	B+
3	ACC

55

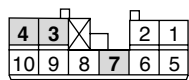

Pin	Signal
4	B+
3	ACC
7	GND

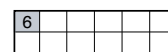
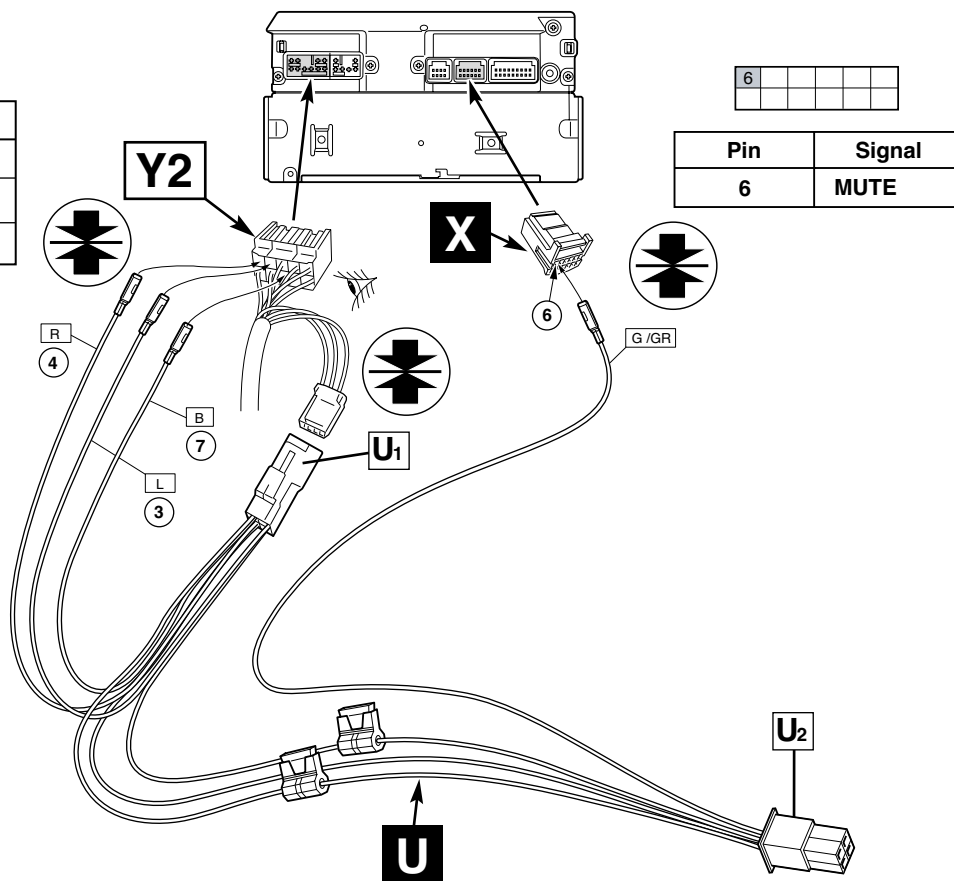

Pin	Signal
6	MUTE

56



