

TOYOTA VEHICLE SECURITY SYSTEM

TVSS IV-S

ELECTRICAL WIRING DIAGRAM

YARIS (RHD)

FOR SCP10R

TOYOTA MOTOR CORPORATION

SYSTEM LAYOUT AND WIREHARNESS OUTLINE(MAIN)

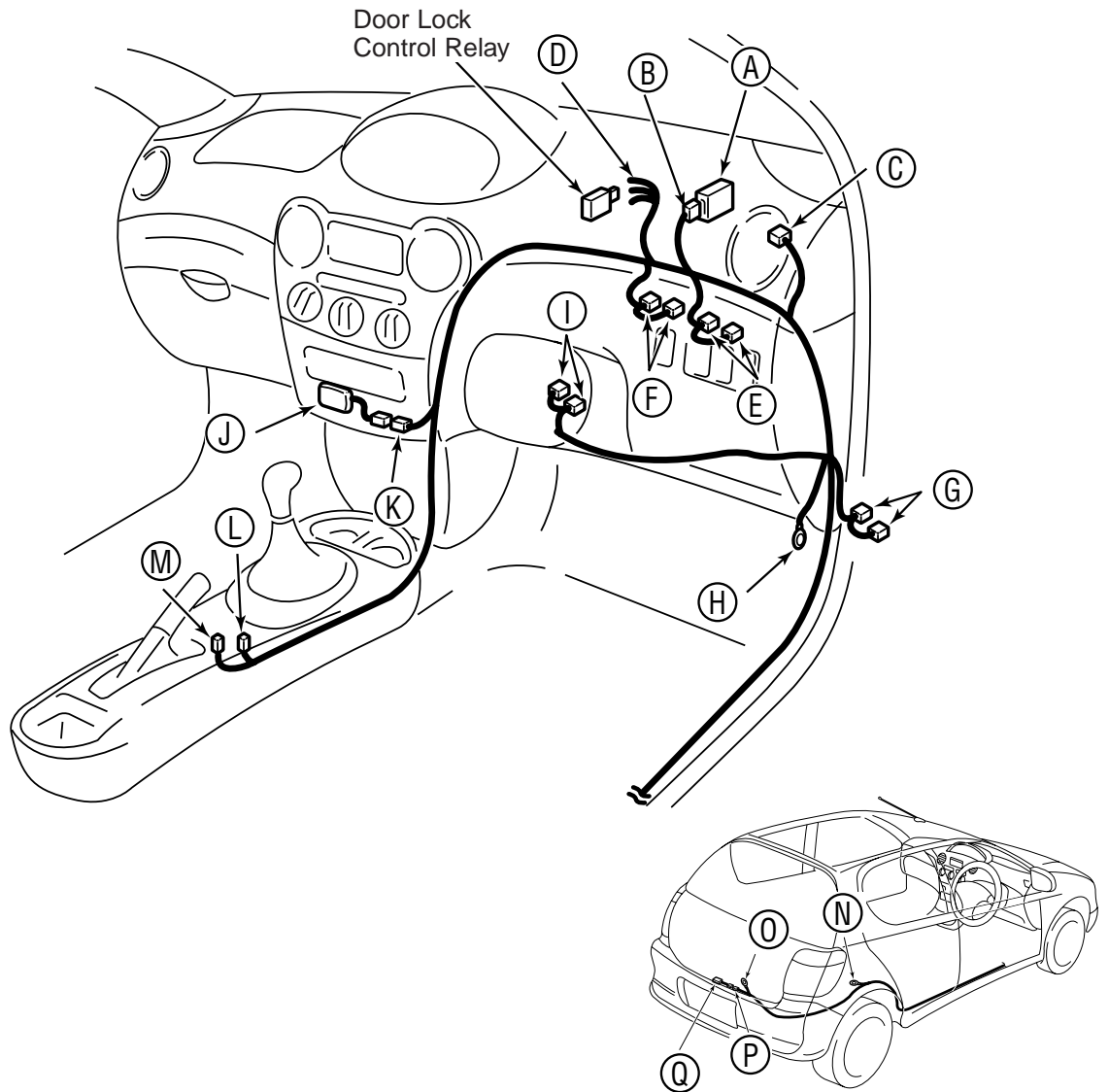

(A)	TVSS IV-S ECU	(J)	Radar Sensor Control ECU
(B)	TVSS ECU Connector (26P Female)	(K)	Radar Sensor Connector (4P White)
(C)	Pre-Wired Connector (5P Male White)	(L)	LED Connector (1P Brown-wired)
(D)	Door Lock ECU Terminal wire (Red/Blue/Yellow)	(M)	LED Connector (1P White/Black-wired)
(E)	Instrument Panel Connector (13P White)	(N)	Ground Terminal
(F)	Roof Connector (9P White)	(O)	Ground Terminal
(G)	Door Lock Connector (14P White)	(P)	Trunk Switch Connector (1P Male Gray)
(H)	Ground Terminal	(Q)	Trunk Switch
(I)	Key Unlock Warning Connector (2P White)		

SYSTEM LAYOUT AND WIREHARNESS OUTLINE(ENGINE)

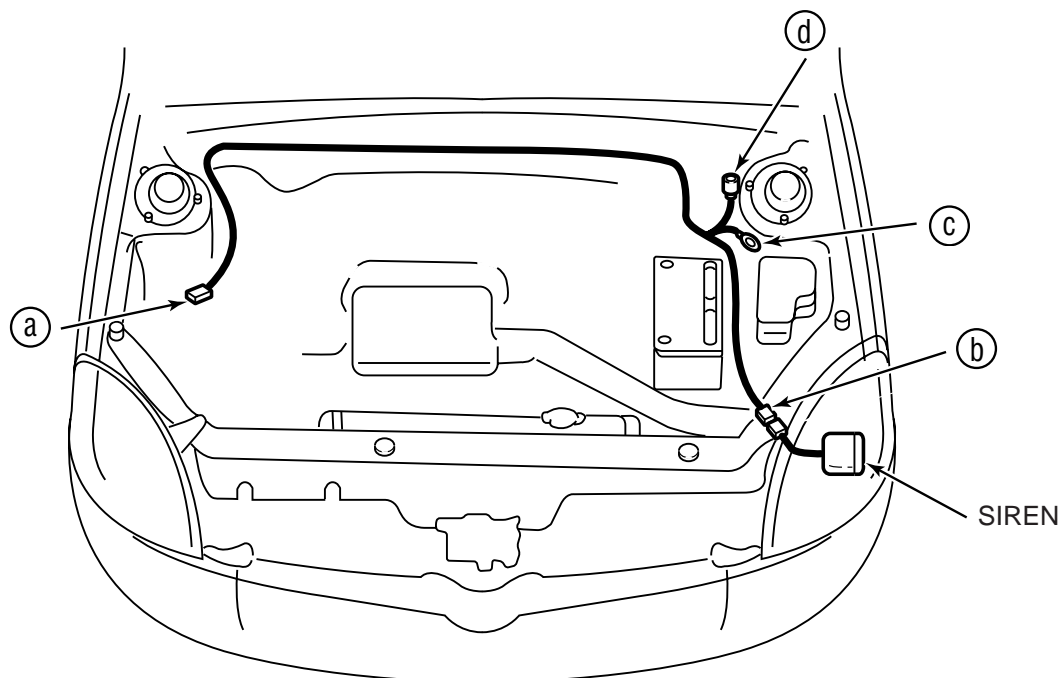

(a)	Pre-Wired Connector (6P Male Gray)
(b)	Siren Connector (6P Female Gray)
(c)	Ground Terminal
(d)	Hood Switch Connector (2P Female White)

YARIS RHD TVSS IV- S

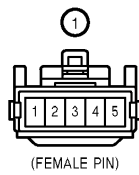
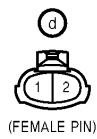
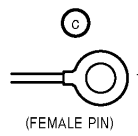
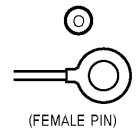
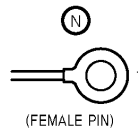
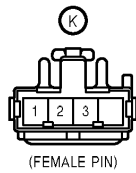
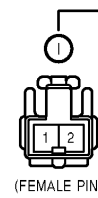
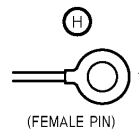
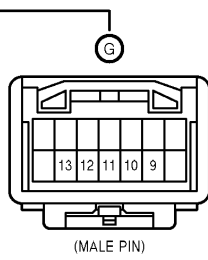
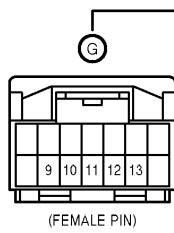
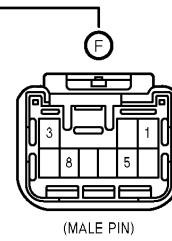
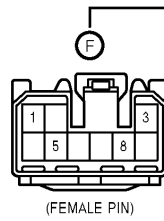
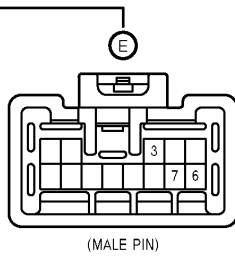
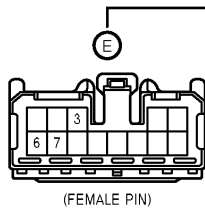
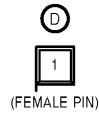
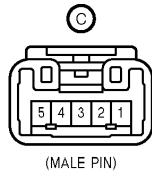
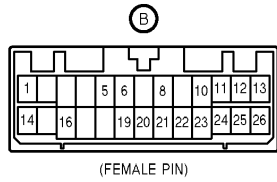

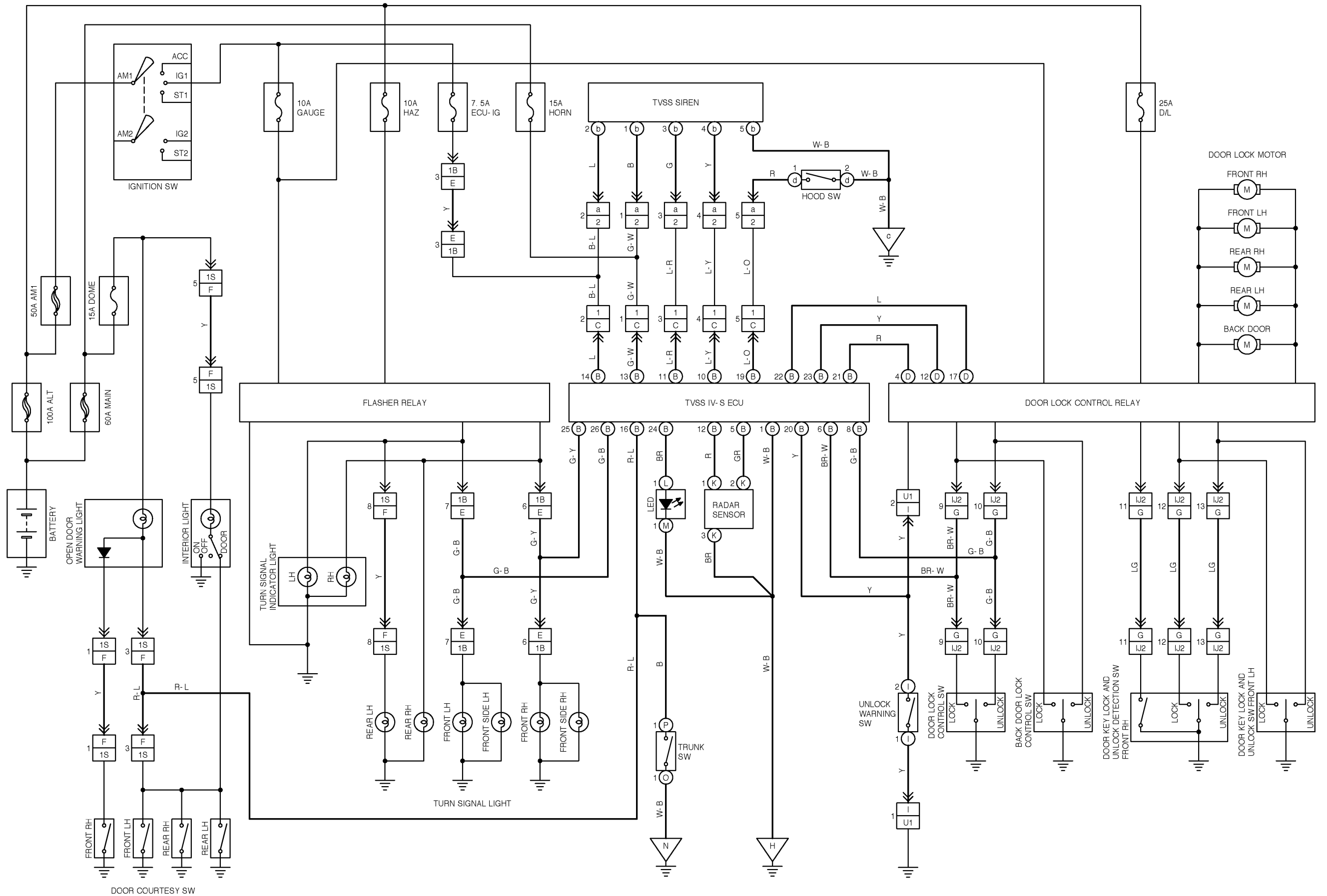

YARIS RHD TVSS IV-S