



**TOYOTA**

ALWAYS A  
**BETTER WAY**

# Toyota C-HR

Leather seats

Check Sheet

Model year: 2016/10  
Vehicle code: \*\*X\*0\*-AH\*\*\*W  
Part number: PW220-10\*\*\*-\*\*

Manual reference number: AIM 003 850-1

# Revision record

Rev. No.	Date	Page	Picture	Update	New	Deleted steps
1	13.10.2016	4-6	X	X	X	

**PW220-10\*\*\*-\*\***

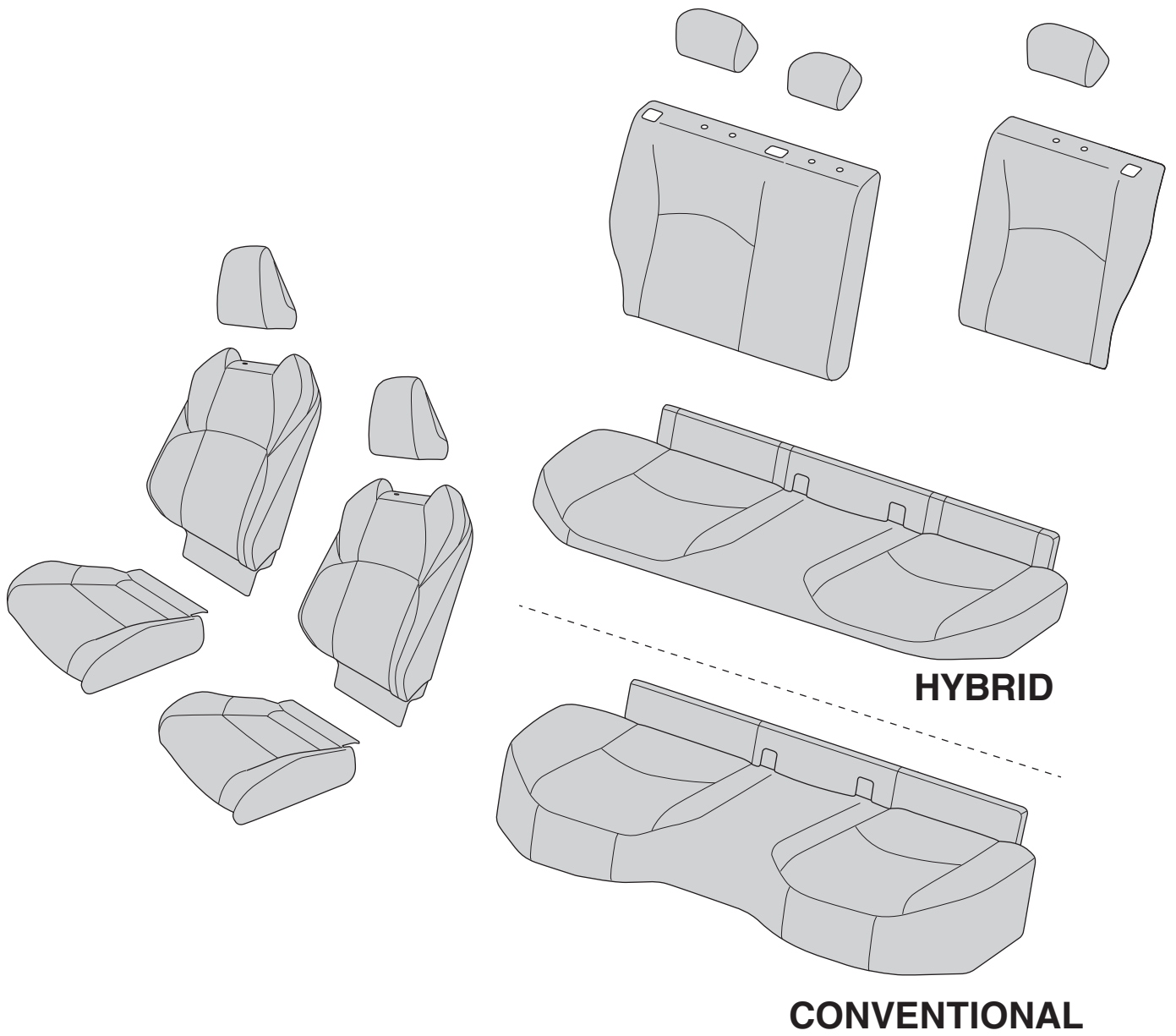

# CHECK SHEET



**TOYOTA**

Model / Year **Toyota C-HR 2016/10** Leather seats

VIN n°

ALWAYS A BETTER WAY

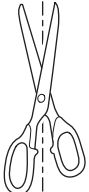
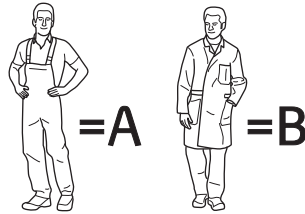
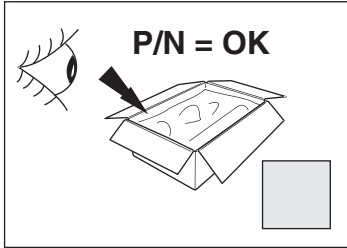

**1 x4**

**S** **!**

**CLICK**

**Serial Number**

1→2→3→...		<b>A</b>	<b>B</b>	<b>A</b>	<b>B</b>
1	4x42Nm	<input type="text"/>	<input type="text"/>	<input type="text"/>	<input type="text"/>

**4x 1**

**S** **!**

**CLICK**

**Serial Number**

1→2→3→...		<b>A</b>	<b>B</b>	<b>A</b>	<b>B</b>
1	4x37Nm	<input type="text"/>	<input type="text"/>	<input type="text"/>	<input type="text"/>

1→2→3→...			
1	OK	<input type="checkbox"/>	<input type="checkbox"/>
2	OK	<input type="checkbox"/>	<input type="checkbox"/>
3	OK	<input type="checkbox"/>	<input type="checkbox"/>
4	Min.+2°C	<input type="checkbox"/>	<input type="checkbox"/>
5	OK	<input type="checkbox"/>	<input type="checkbox"/>
6	OK	<input type="checkbox"/>	<input type="checkbox"/>

**HYBRID**

**CONVENTIONAL**

**Serial Number**

1→2→3→...		A	B
1	4x37Nm	<input type="checkbox"/>	<input type="checkbox"/>
2	Click	<input type="checkbox"/>	<input checked="" type="checkbox"/>
3	Click	<input type="checkbox"/>	<input checked="" type="checkbox"/>

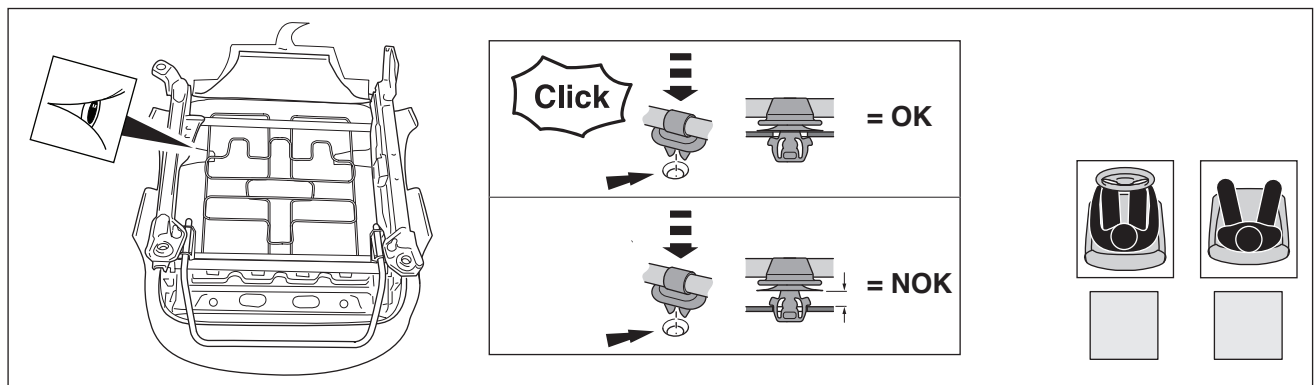
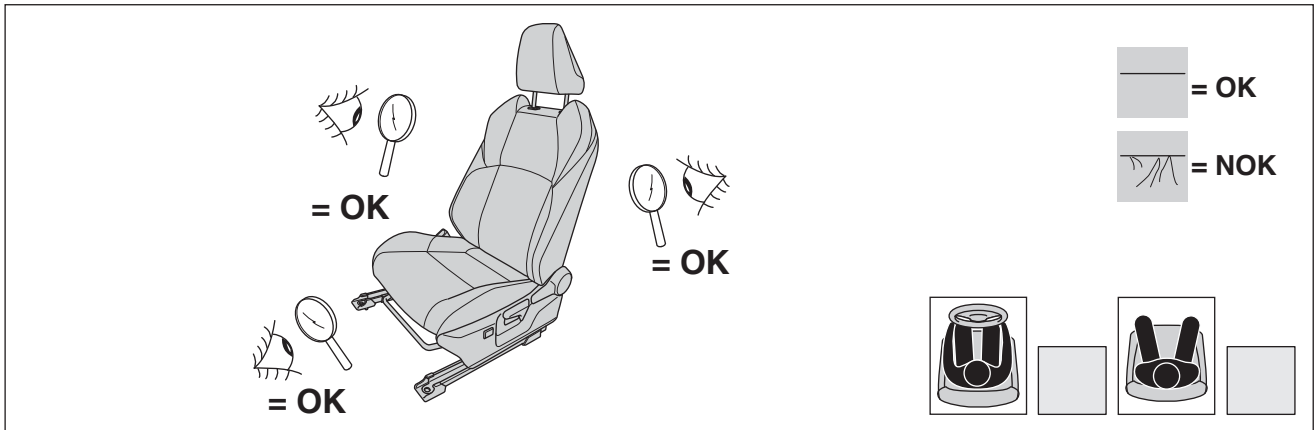
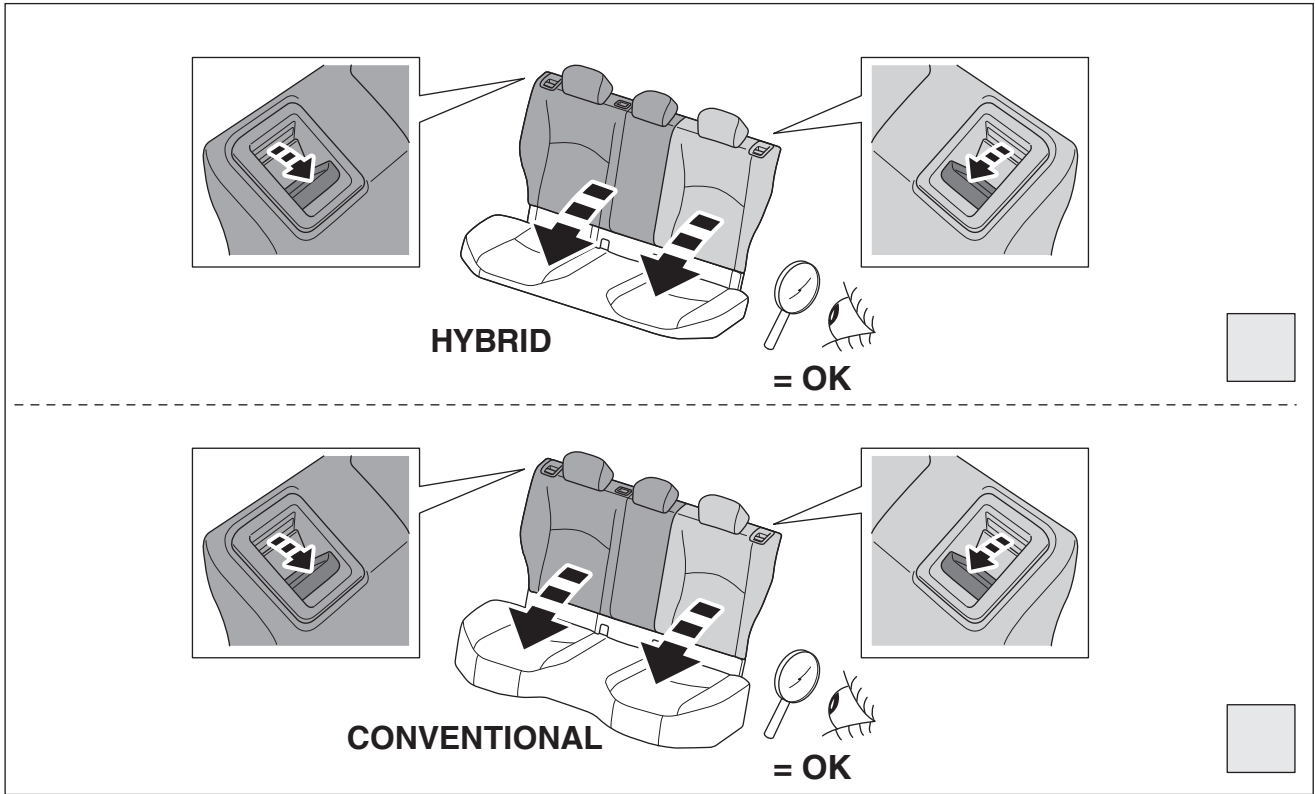
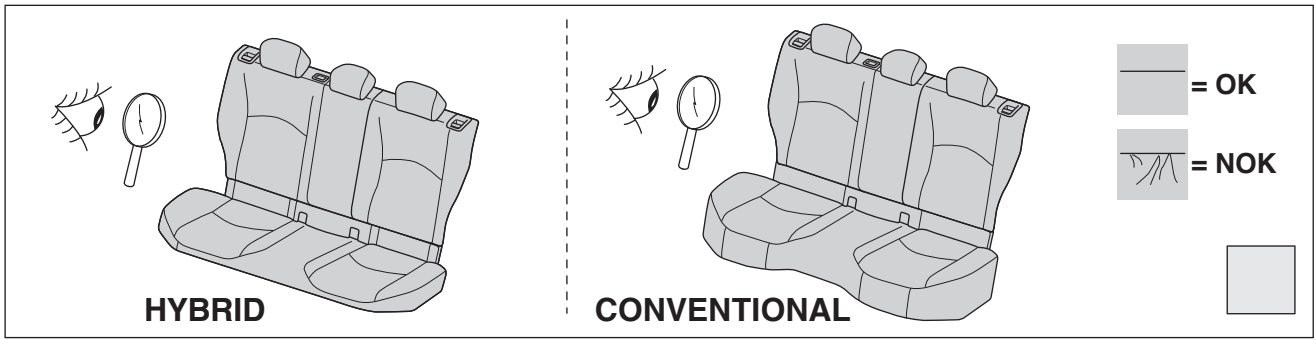

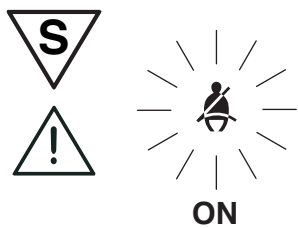
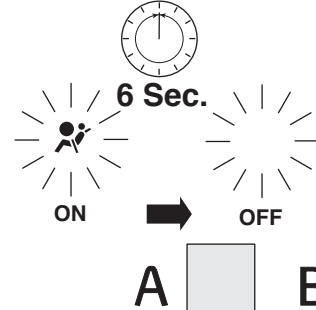
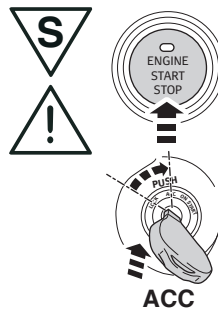
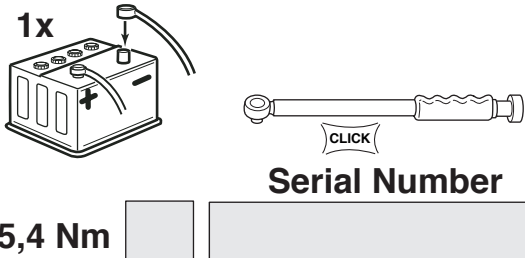
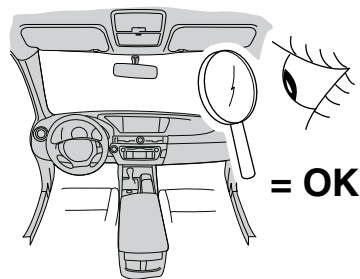
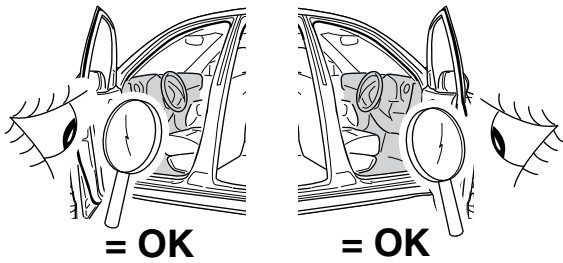
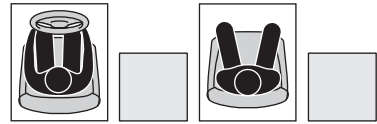
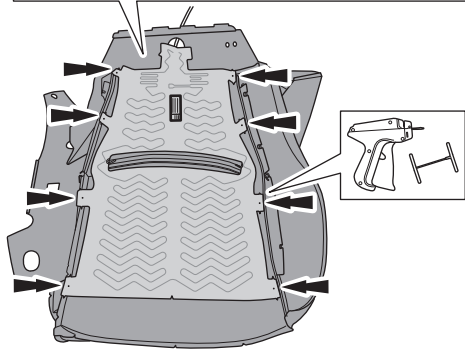
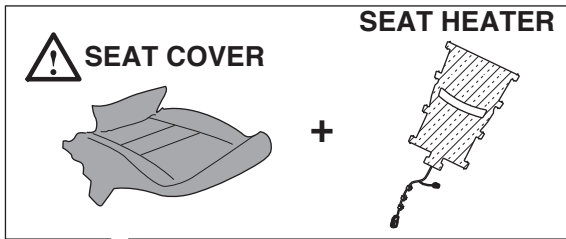

**A**  **B**

 **For full Installation instructions  
Repair manuals**



<http://www.toyota-tech.eu>

**Installation Date:**

... / ... / ...

**Technician Name & Signature:**

**Stamp:**