

Corolla Cross

Rear Lower Trunk Garnish

Installation Instructions

Model year: As from 2022/08

Vehicle code: ZVG12L-KHX*BW
MXGH1**-KHX*HW

Part number: PW405-16100-01

Latest Version
SCAN HERE



Revision Record

Rev. No.	Date	Page	Step	Remarks
△ ₁	05.05.2023			Updated to latest Standards

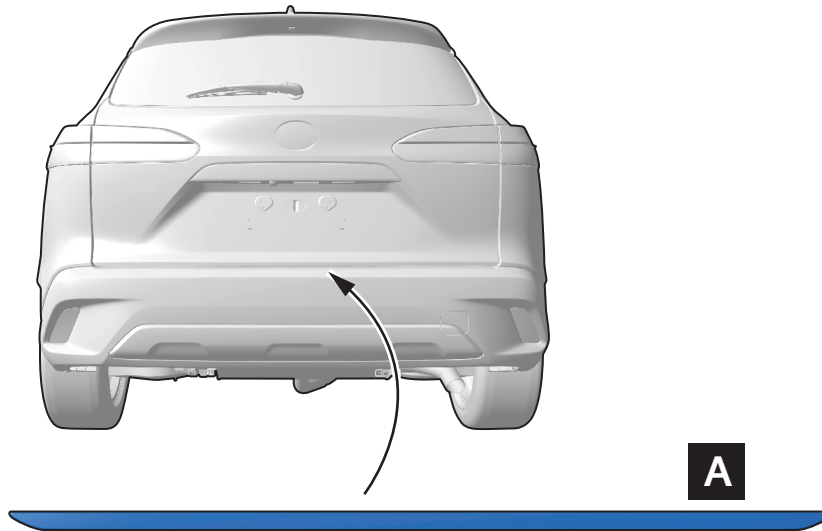

x1

TOOLS

TEMPERATURE SENSOR	TAPE MEASURE	PRESSURE ROLLER		

CONSUMABLES

CLEANER / DEGREASER SPRAY	MASKING TAPE		
<p>AIM 003 516-*</p>			

PERSONAL PROTECTION EQUIPMENT

PROTECTIVE GLOVES				For Symbols Explanation SCAN HERE

GENERAL



Material Safety Data Sheet



Technical Data Sheet

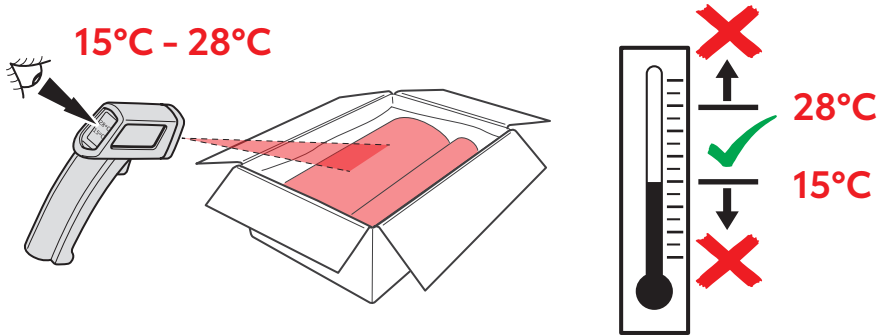
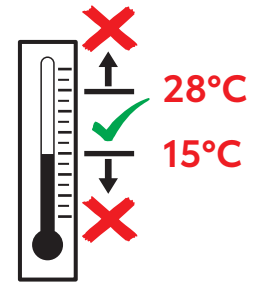
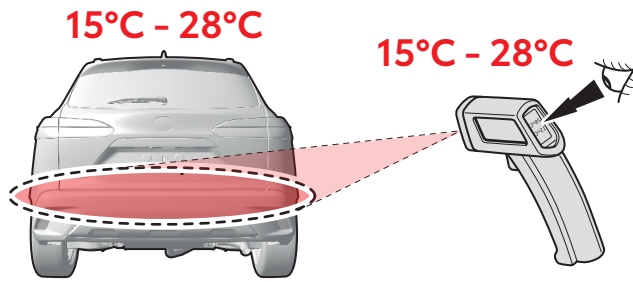

INSTALLATION INSTRUCTIONS

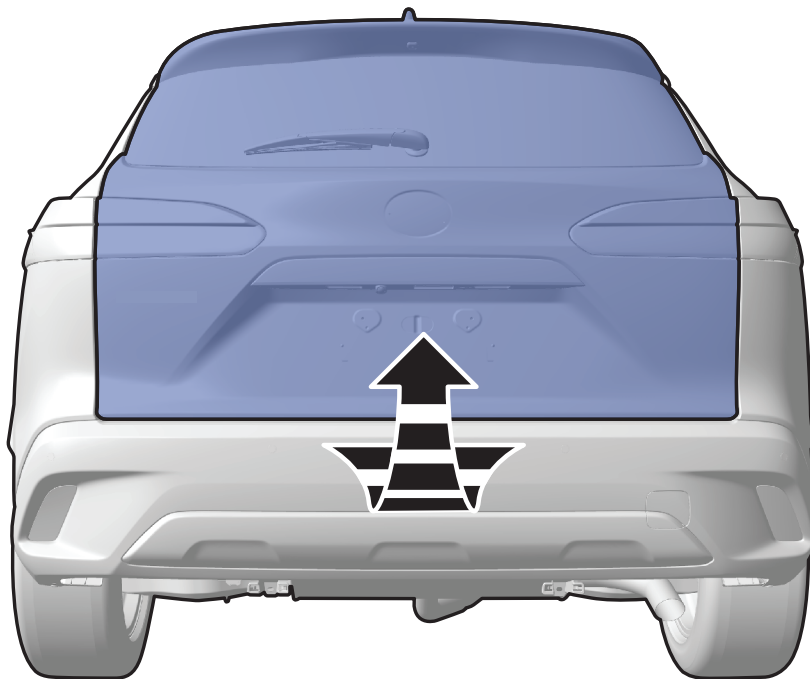

1

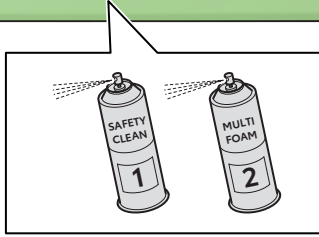

2

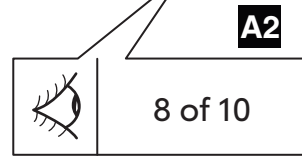
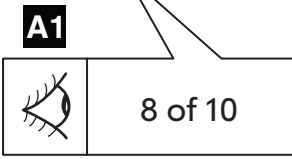

3

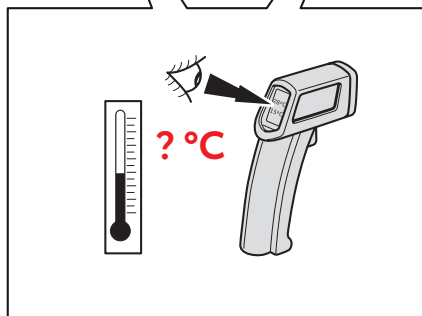

4

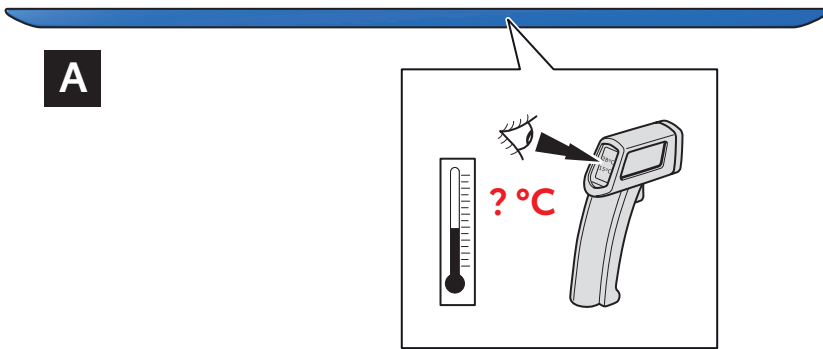

5

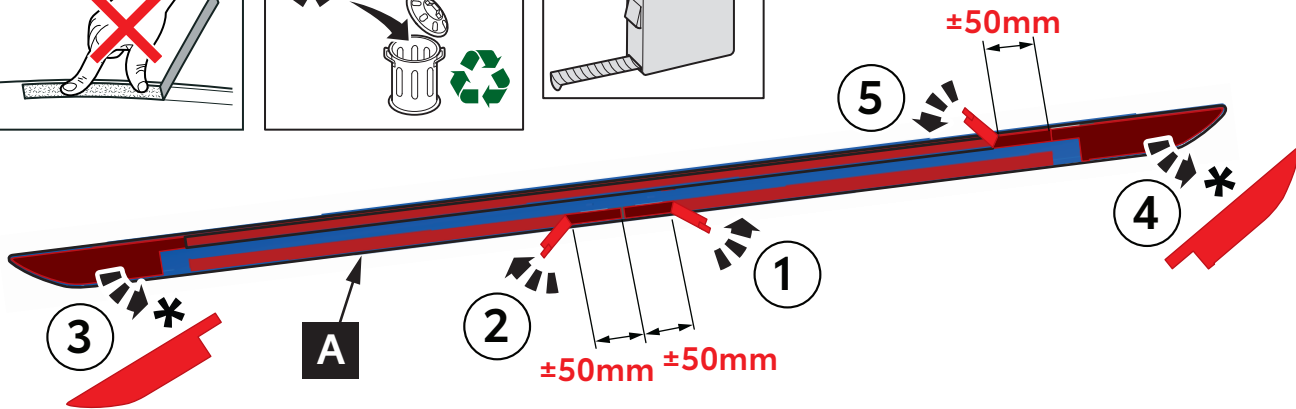
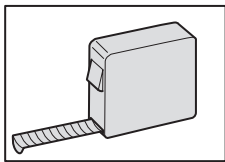
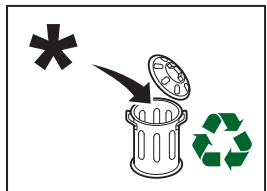
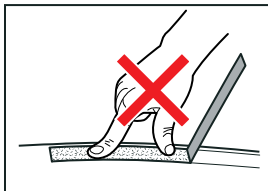

6

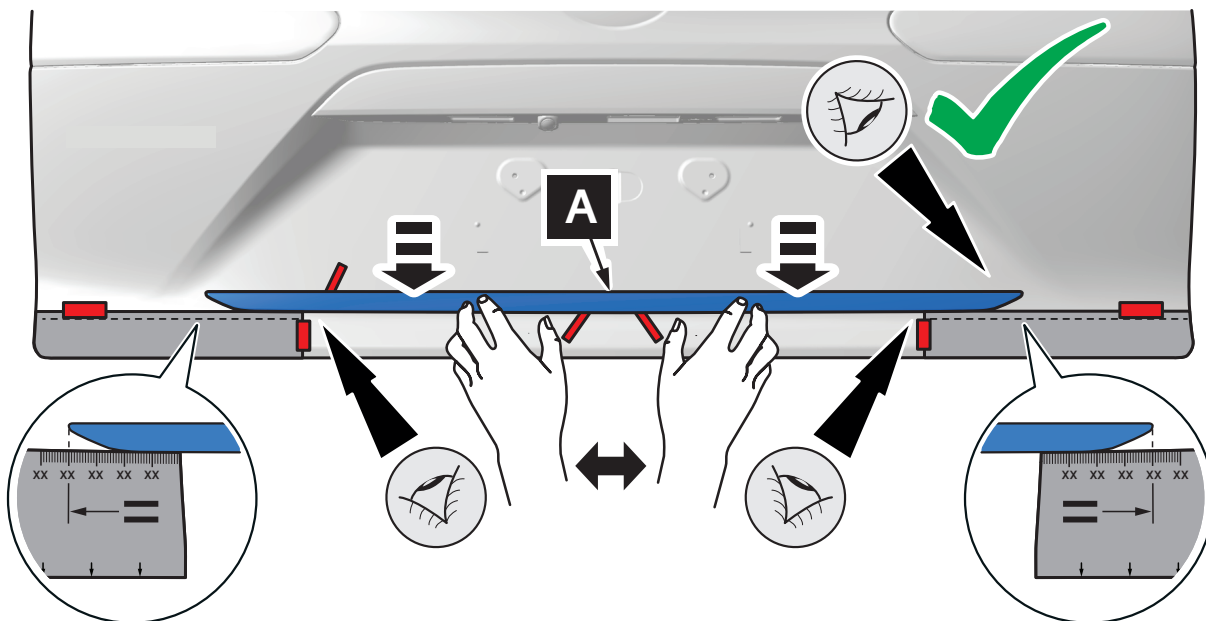

7

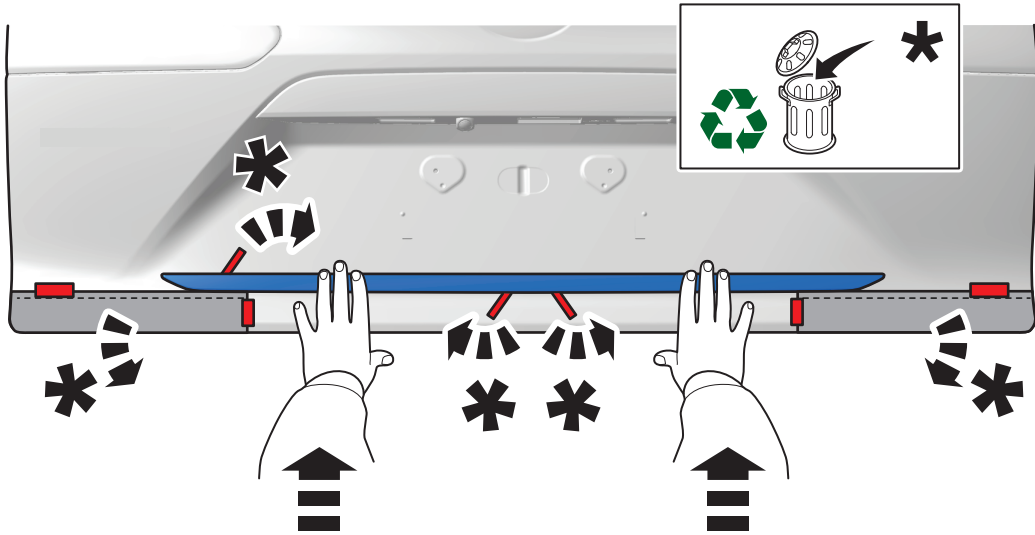

8

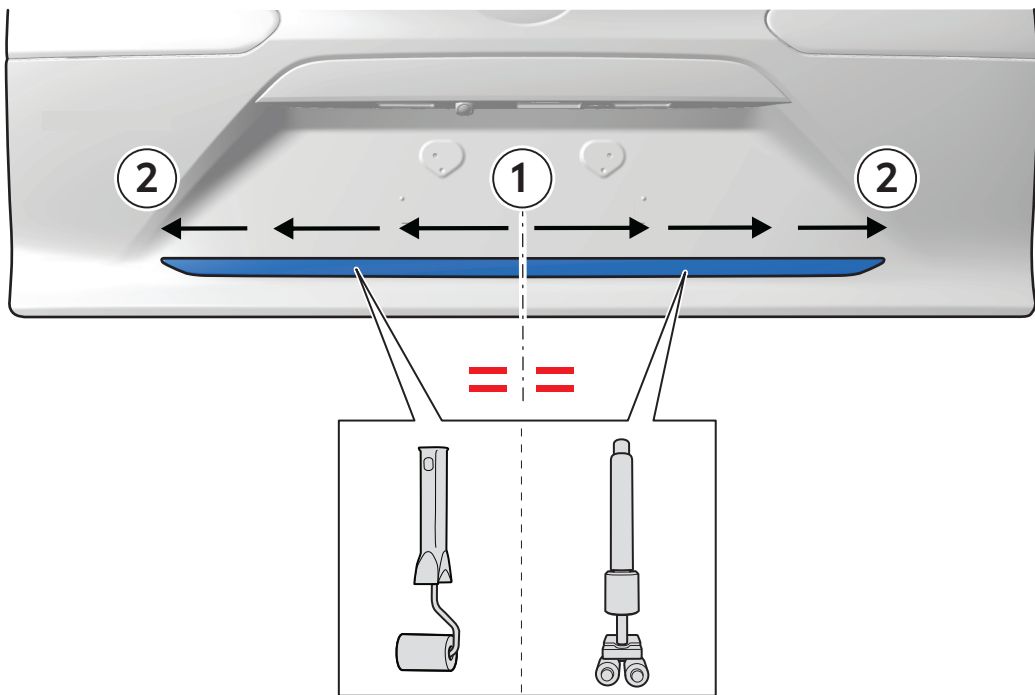

9

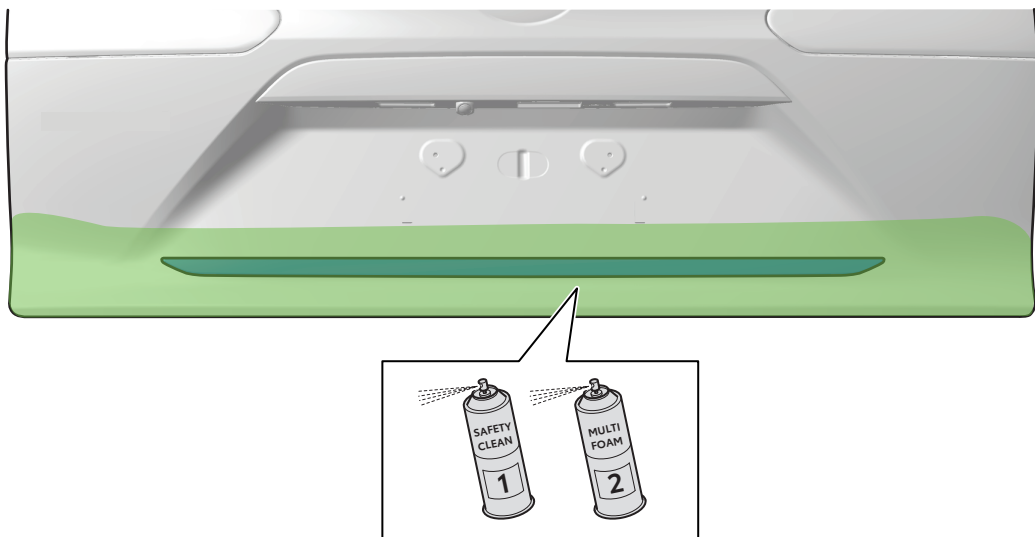

10

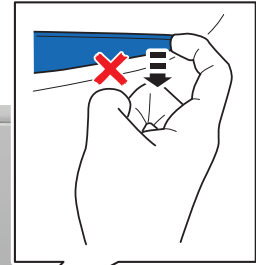
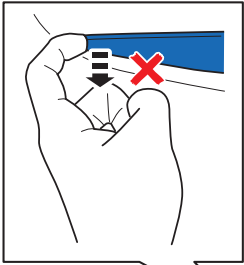

11

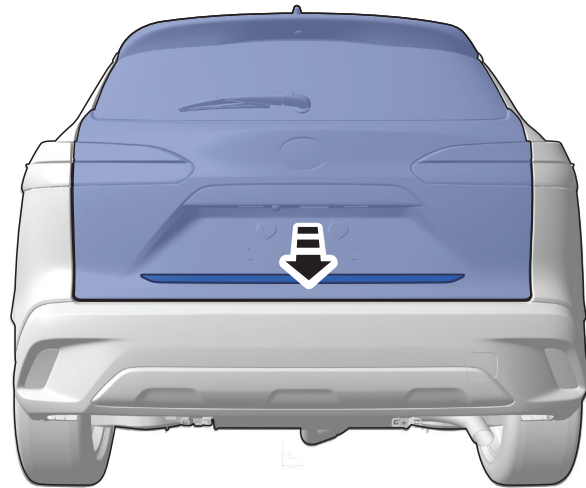

12

GENERAL

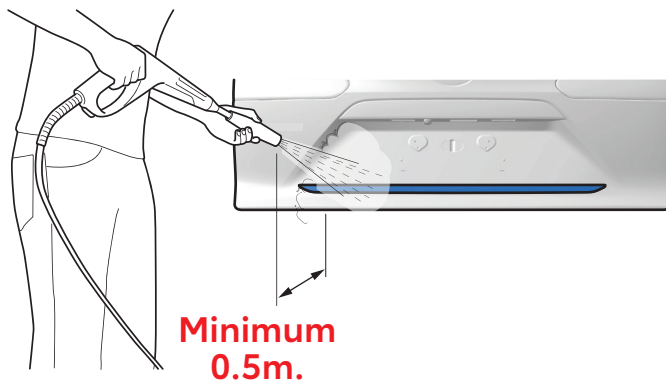
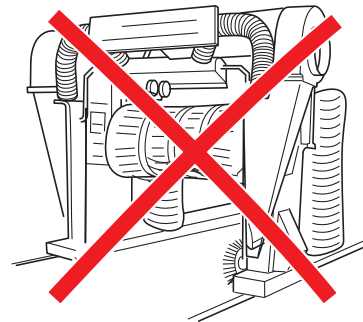
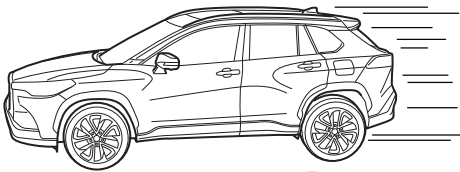



CHECK SIZE
Print 100%
Check with rulers
before use.

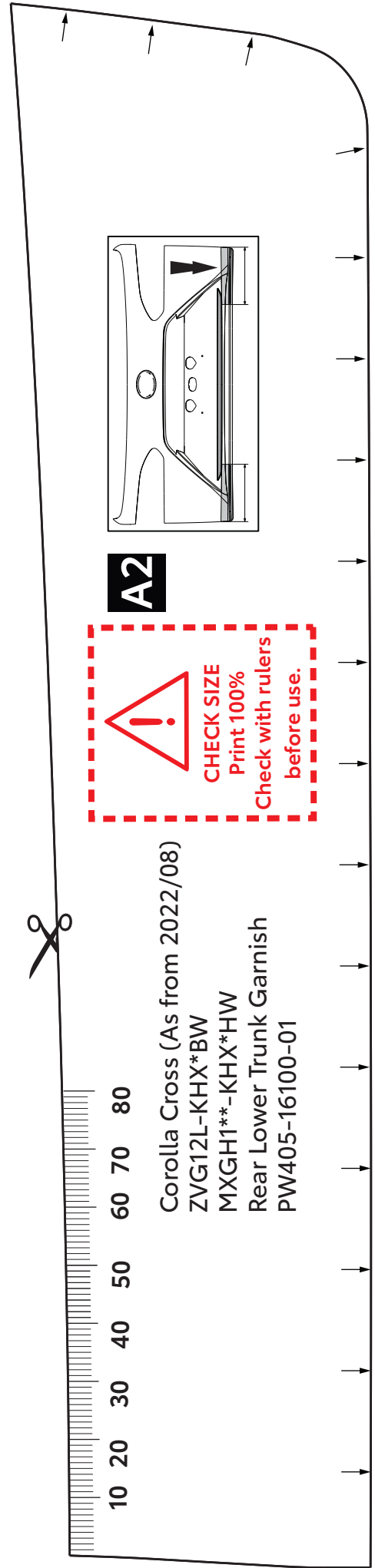
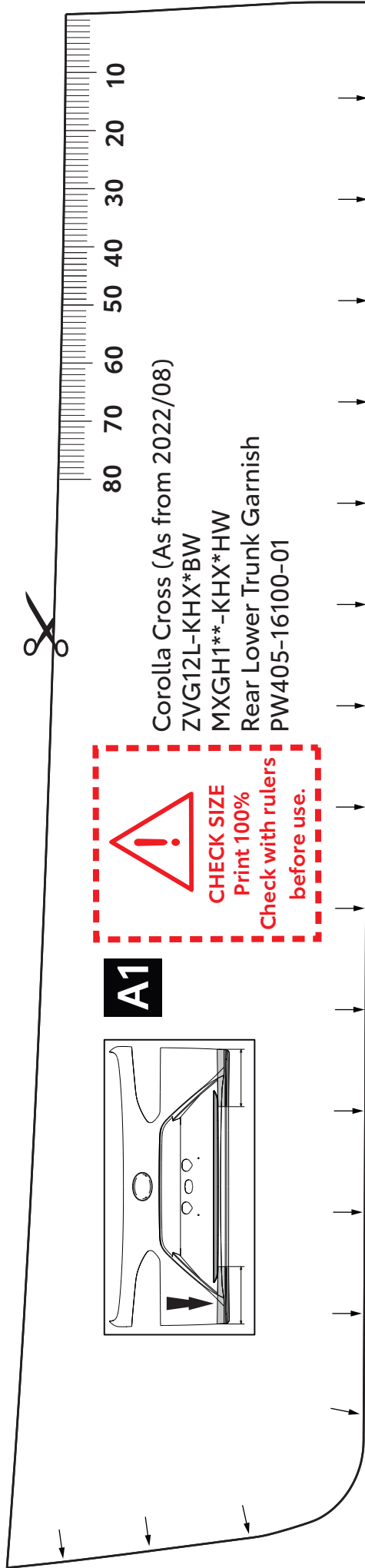

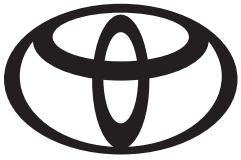

CHECK SHEET

Page 1 of 1

Model/Year **Corolla Cross**
As from 2022/08

Rear Lower Trunk Garnish

VINn°

DURING INSTALLATION

1

= OK
P/N = OK

2

3

AFTER INSTALLATION

1

2

= OK

Installation Date:
 . . / . . /

Technician Name & Signature:

Stamp: