

Universal Manual

Anti-Theft Wheel Bolts / Nuts

Installation Instructions

Part number: PW456-000**

Latest Version
SCAN HERE



Manual reference number: AIM 003 489-5

CLICK TO NAVIGATE



REVISION RECORD



Page

3

KIT CONTENT



Page

4

TOOLS



Page

4

USEFUL GENERAL MANUALS



Page

4

GENERAL



Page

5

INSTALLATION INSTRUCTIONS



Pages

6 - 7

CHECK SHEET



Page

8

THINK BEFORE YOU PRINT



**ONLINE = LATEST VERSION
GO DIGITAL!**

Revision Record

Rev. No.	Date	Page	Step	Remarks
5	18.10.2023			Updated to latest Standards.
5	18.10.2023	6, 7	2 -3	Tools updated
5	18.10.2023	8	CS	Detail 4x/5x wheel added

KIT CONTENT

PW456-000**

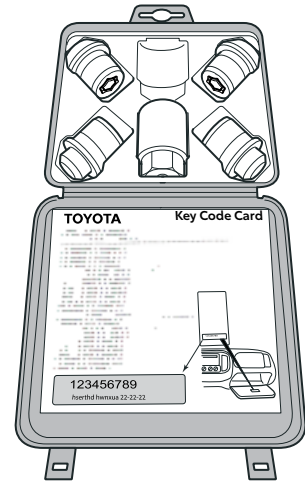

ANTI THEFT BOLT

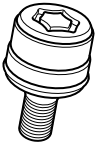

4/5x

ANTI THEFT NUT

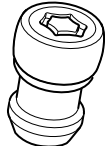

4/5x

B



1x

C

1x

TOOLS

TORQUE WRENCH

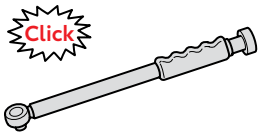

RATCHET

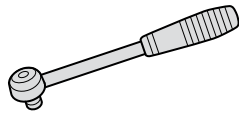

HEXAGONAL DEEP SOCKET

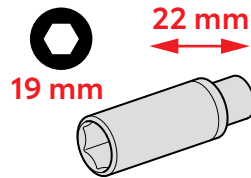

TORQUE STICK

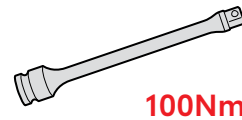

SOCKET/IMPACT TOOL

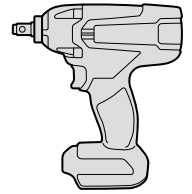

4 POST CAR LIFT

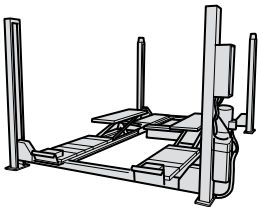

2 POST CAR LIFT

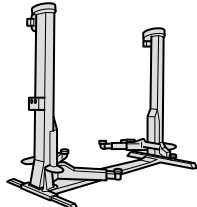

USEFUL GENERAL MANUALS

WHEEL TORQUE VALUES

Latest Version
SCAN HERE

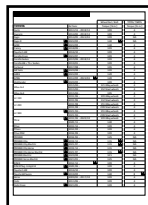

SYMBOLS

Latest Version
SCAN HERE



GENERAL



ANTI THEFT BOLT



A

4/5x

ANTI THEFT NUT

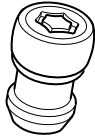

4/5x

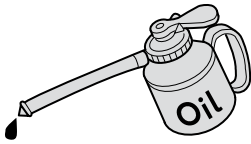

Oil



GREASE

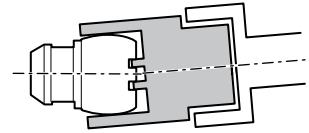
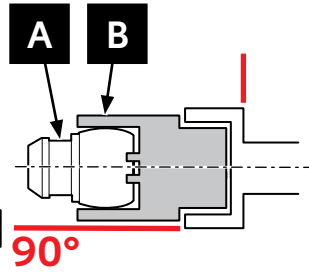

GENERAL

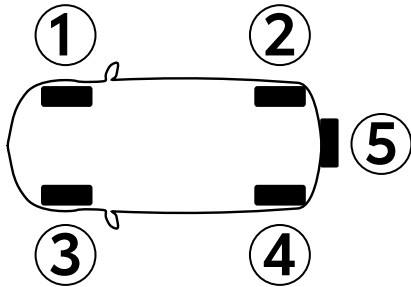

5x

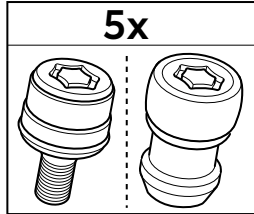

Prod 2009/09 < Land Cruiser 150
Prod 2010/02 < RAV4

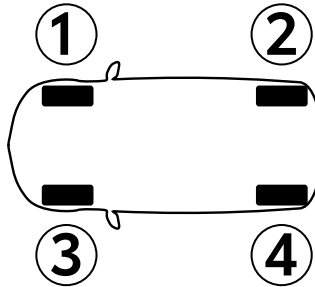

4x

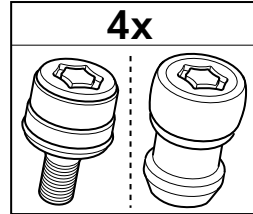

INSTALLATION INSTRUCTIONS

1



1



2

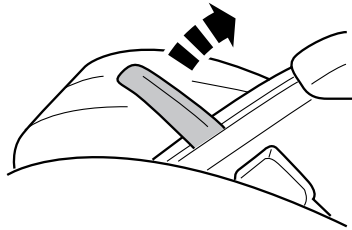

1

5

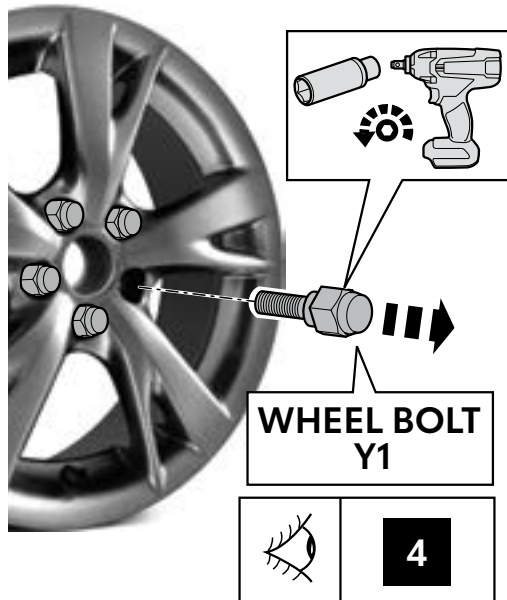

2

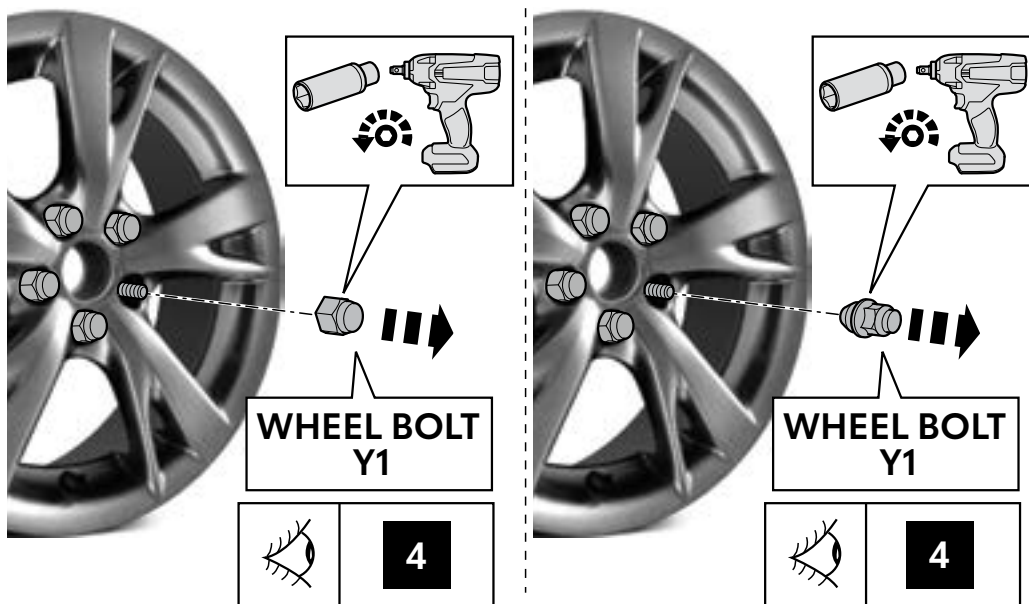



ANTI THEFT BOLT

ANTI THEFT NUT

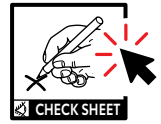

5

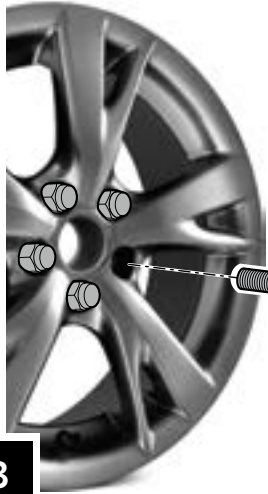

X

1

2

A

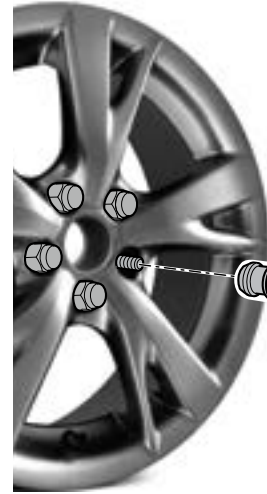

X

1

2

A

3

B

WHEEL BOLT

WHEEL NUT

Y1

x4/5

Y1

x4/5

Y1

x4/5

4

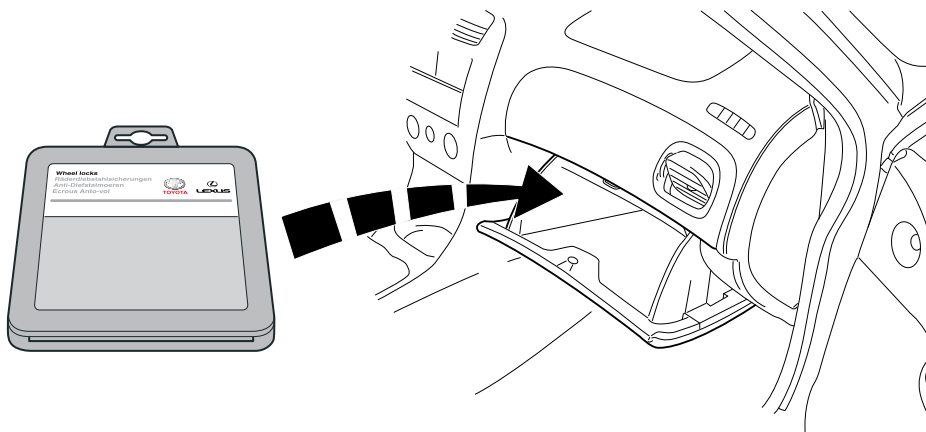

5

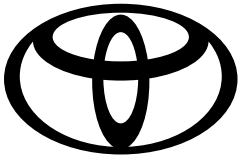

CHECK SHEET

Page 1 of 1

Anti-Theft

Wheel Bolts / Nuts

Model/Year

Universal Manual

VINn°

DURING INSTALLATION

1

P/N = OK

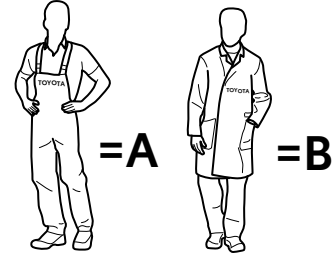

2

Prod 2009/09<Land Cruiser 150
Prod 2010/02<RAV4

1

Serial Number

1→2→3→...		A	B
1	Nm	<input type="text"/>	<input type="text"/>
	AIM 004 425-*		

AFTER INSTALLATION

1

Prod 2009/09<Land Cruiser 150
Prod 2010/02<RAV4

2

Installation Date:

.. / .. / ..

Technician Name & Signature:

Stamp: