



TOYOTA

ALWAYS A
BETTER WAY

Toyota C-HR

Hood Protector

Installation Instructions

Model year: 2016/10
Vehicle code: **X***-AH***W
Part number: PW421-10000

Manual reference number: AIM 003 790-0

Revision record

Rev. No.	Date	Page	Picture	Update	New	Deleted steps

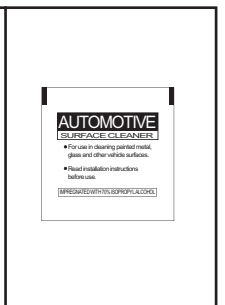
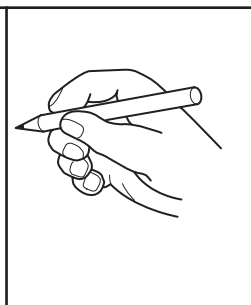
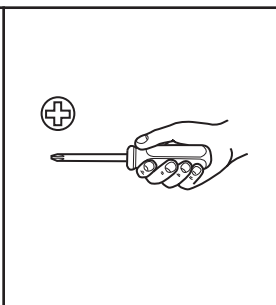
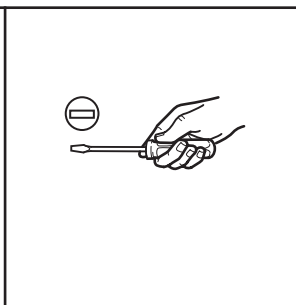
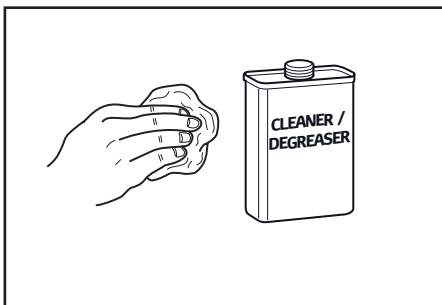
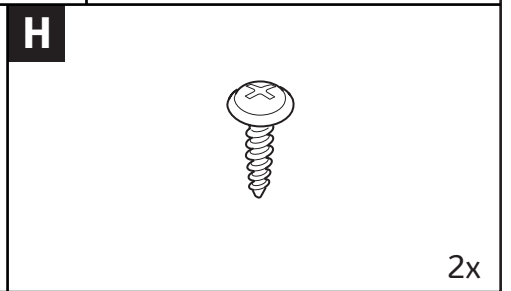
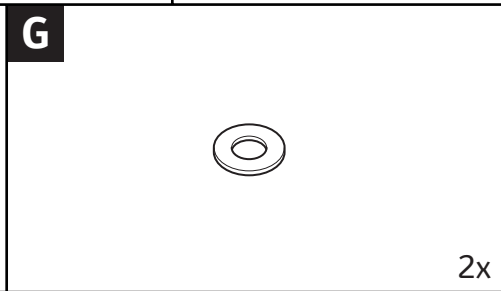
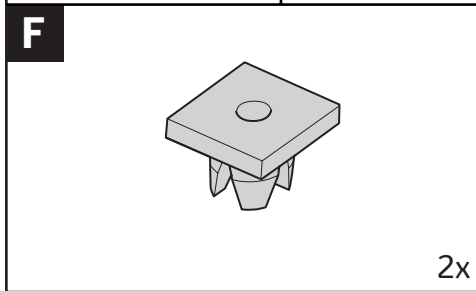
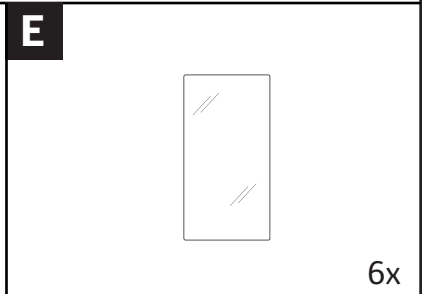
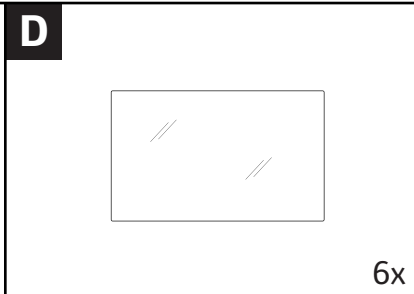
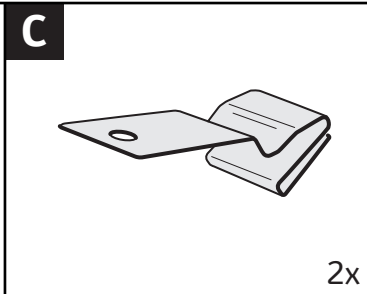
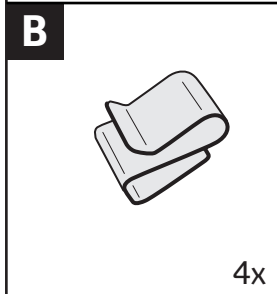
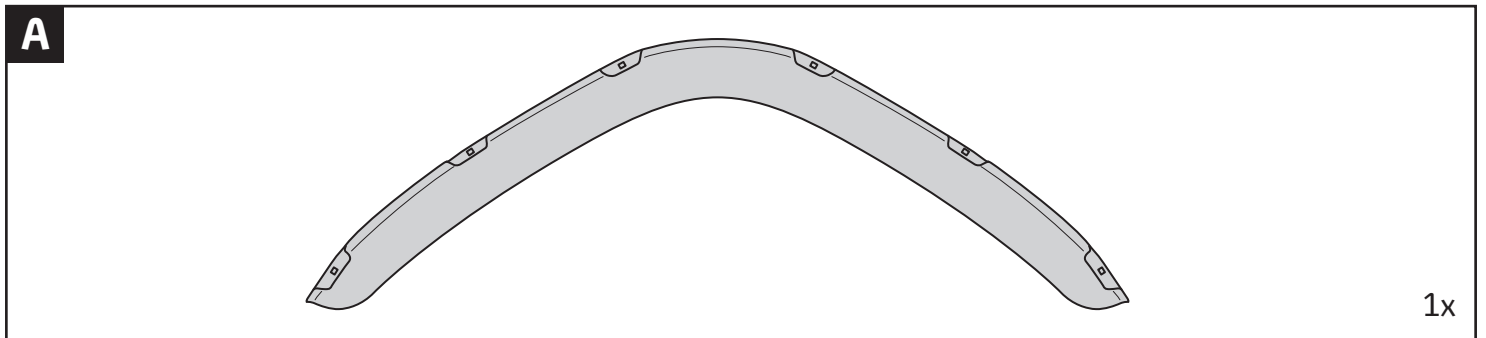



40°C

18°C

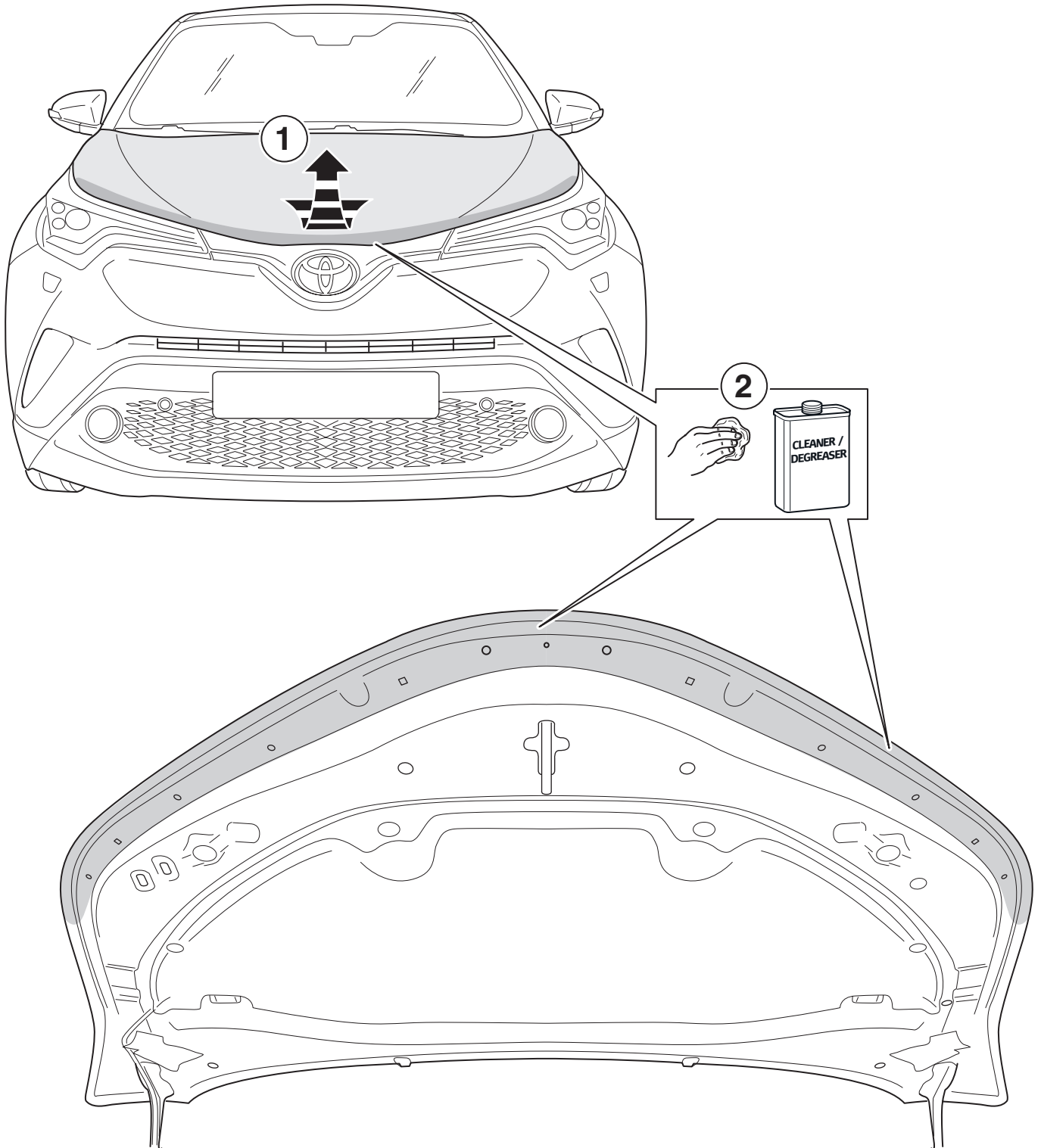

2

6x

2

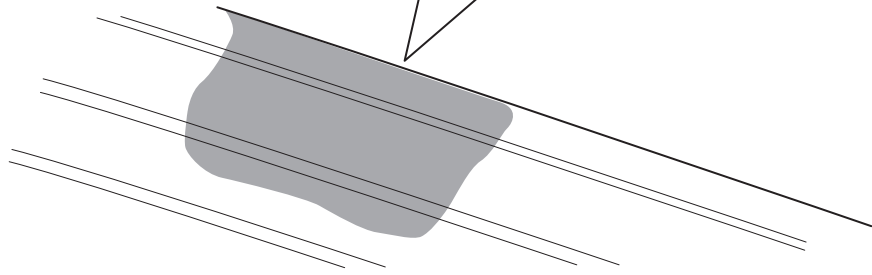
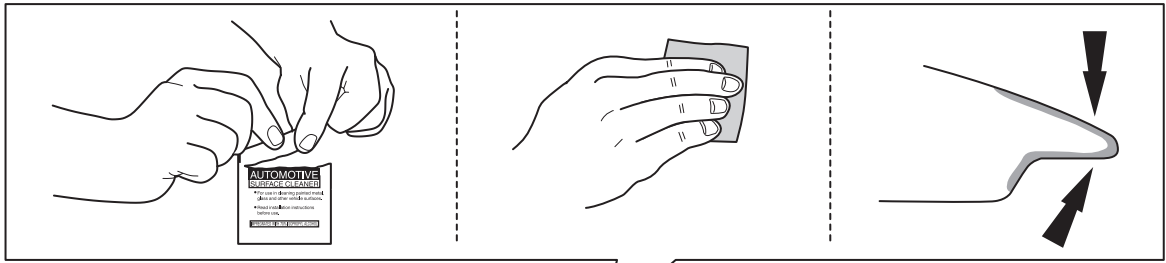

6x

3

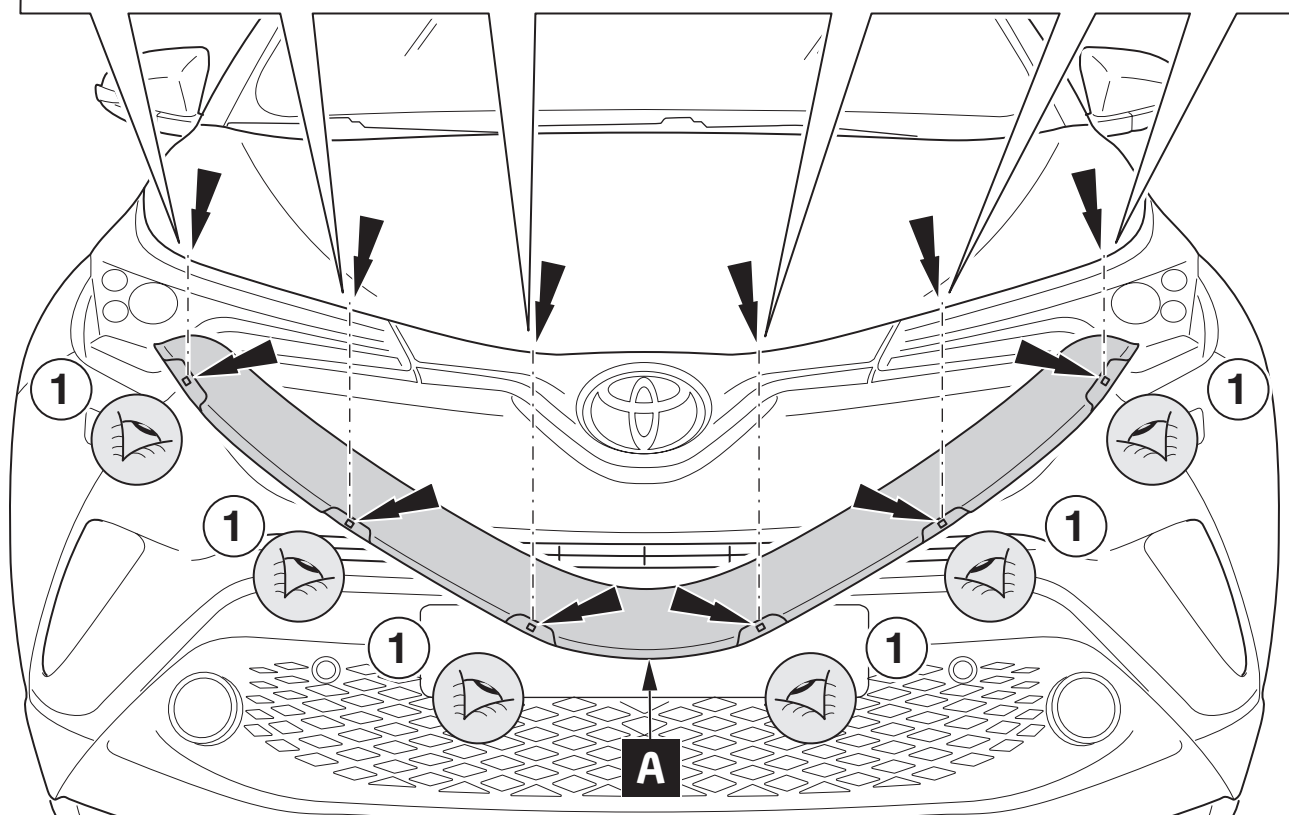
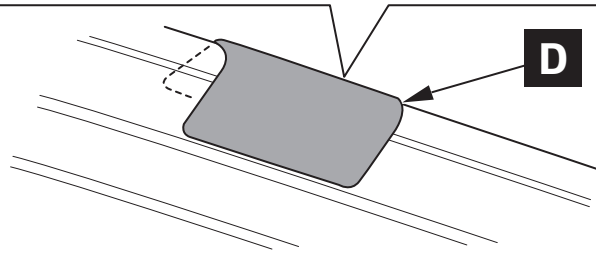
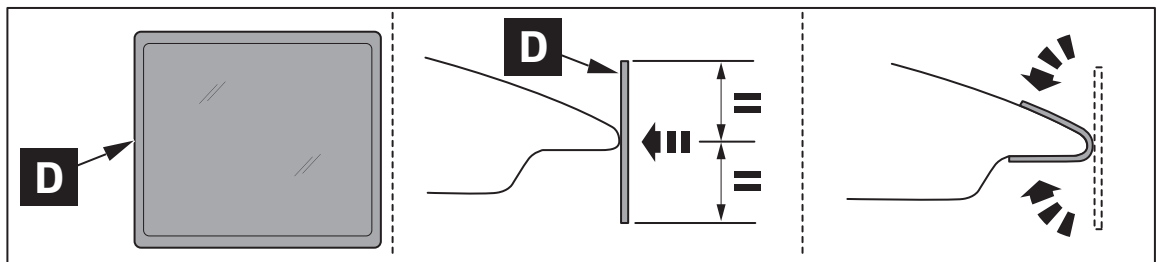

2

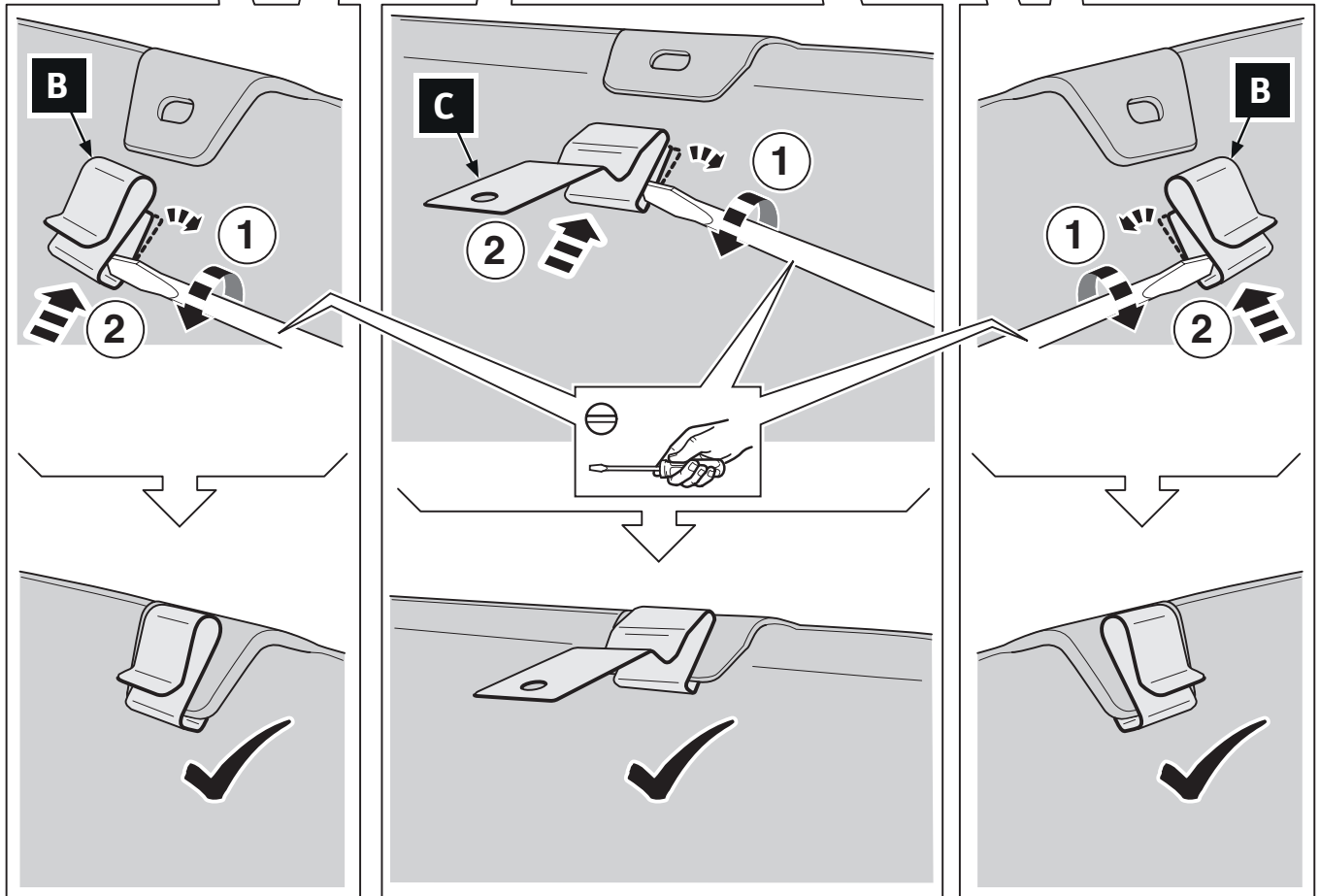
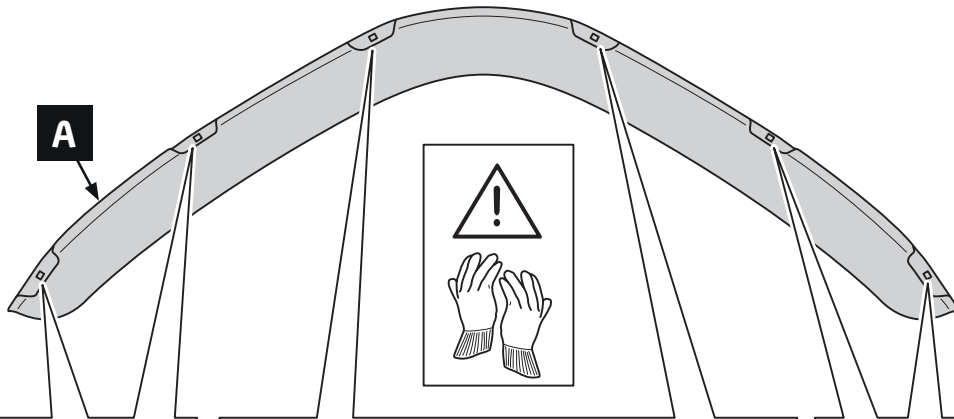
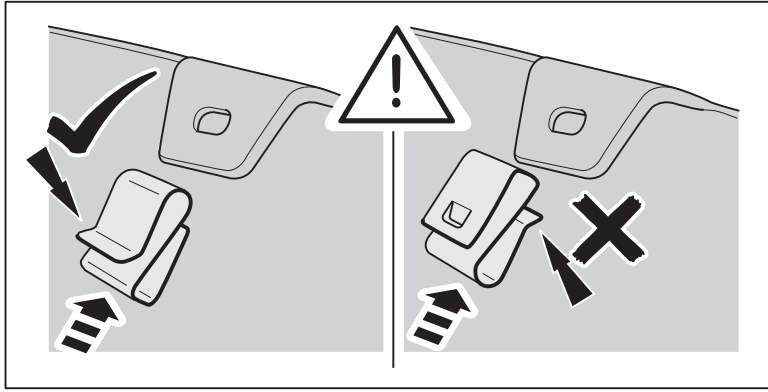

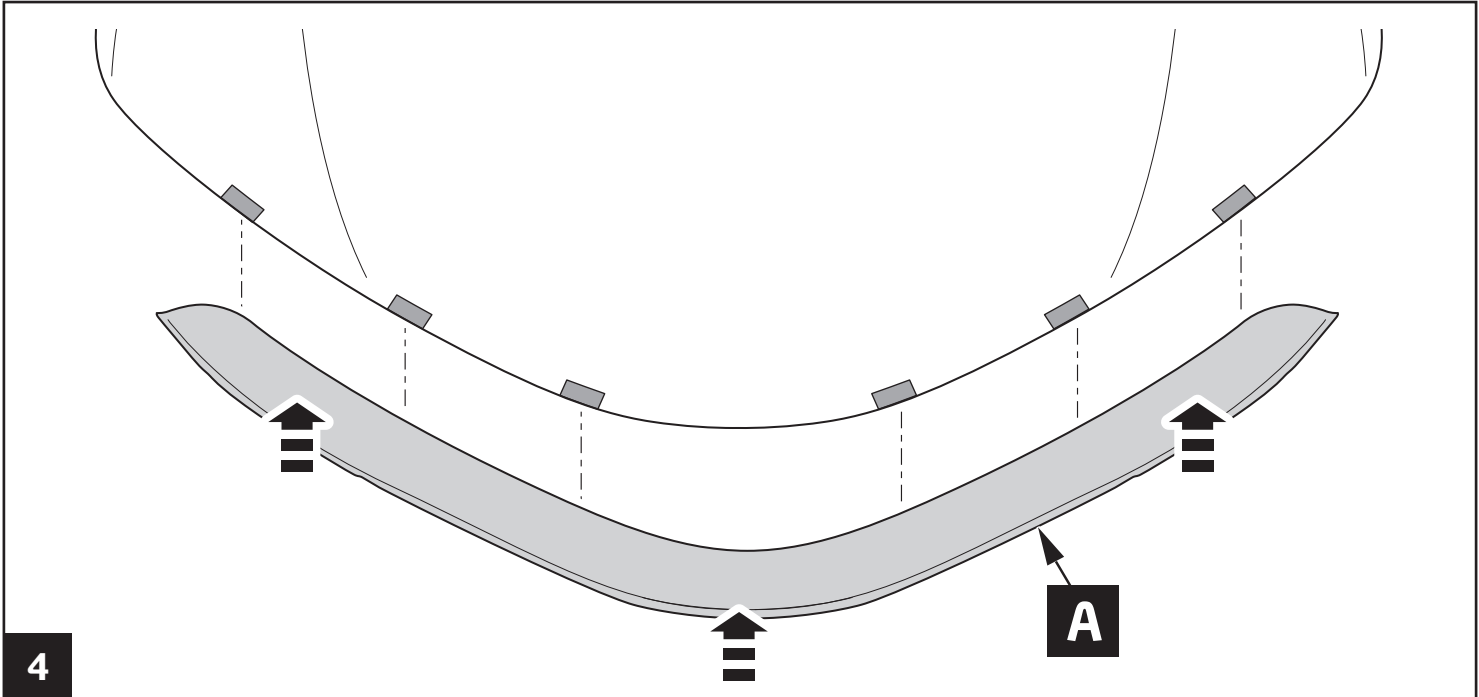

4

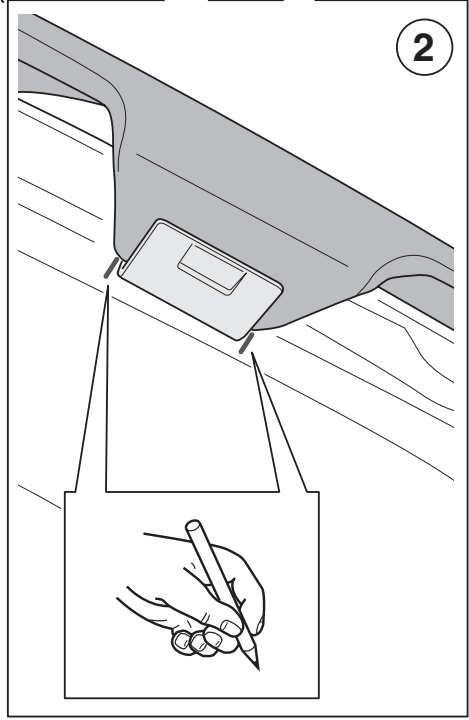
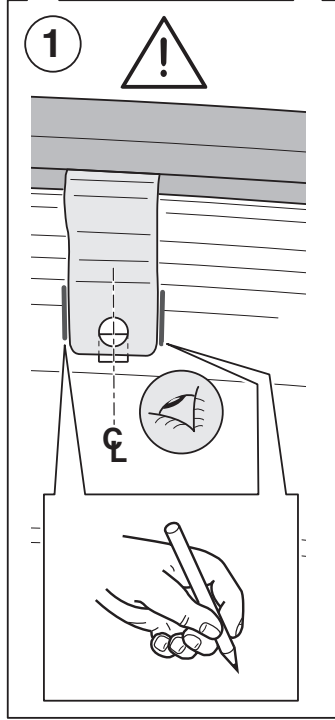
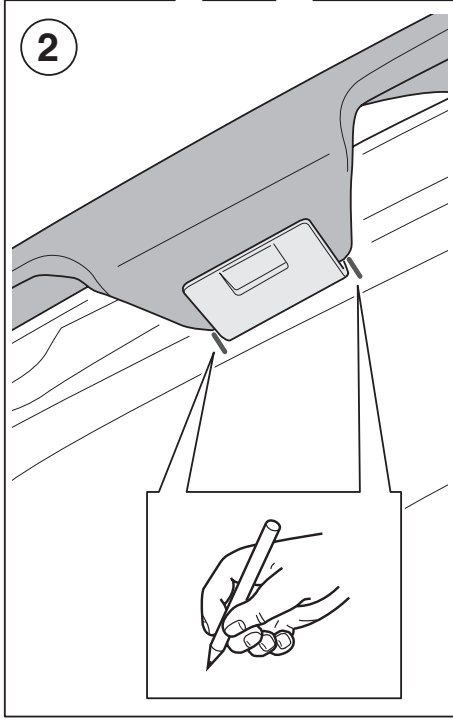
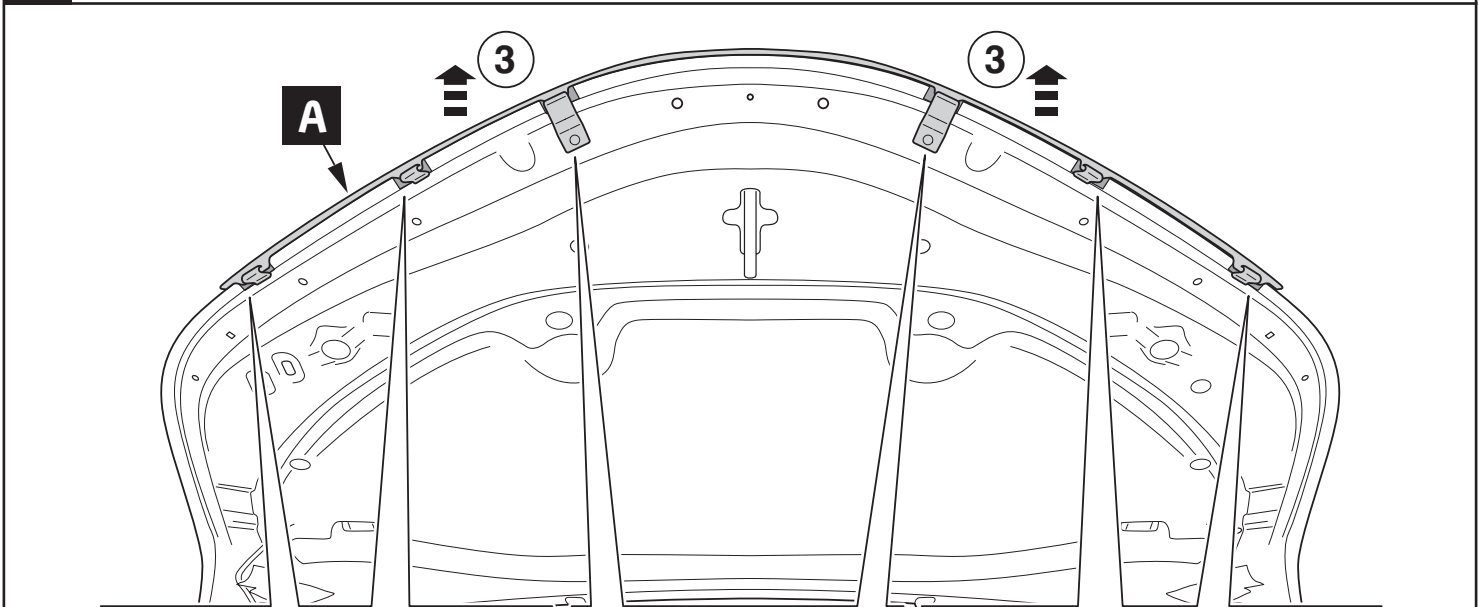

5

6x

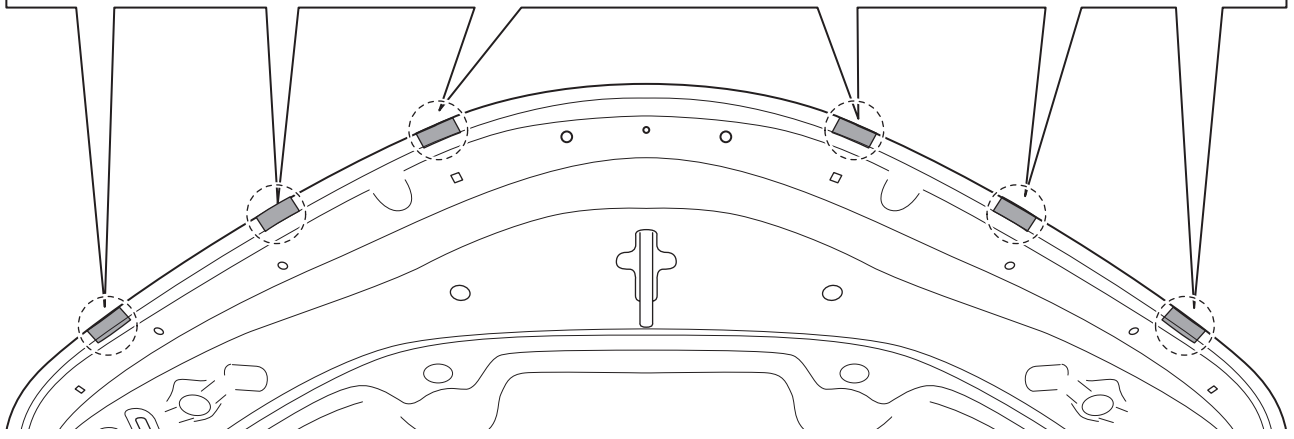
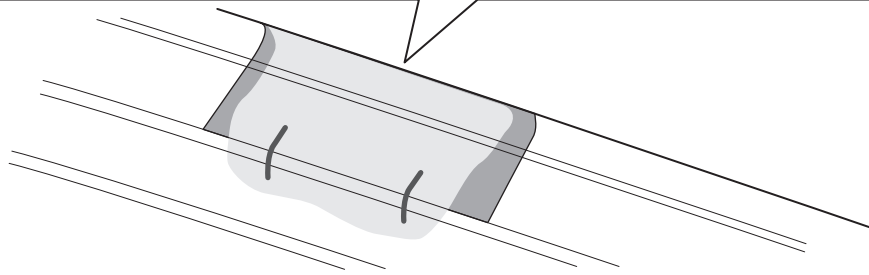
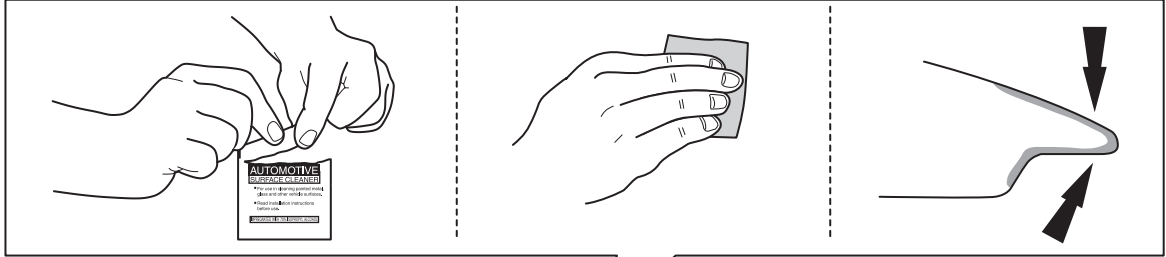

6

6x

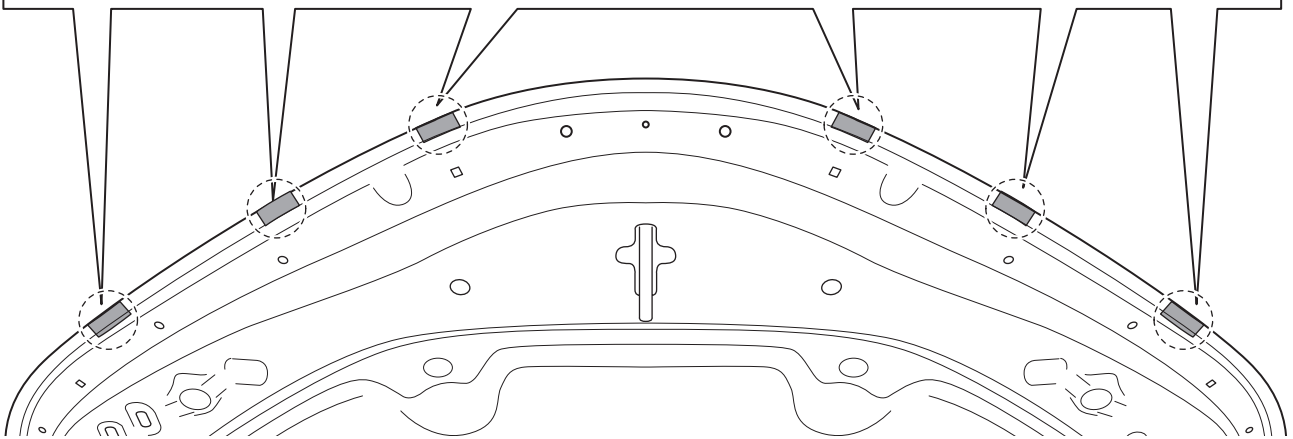
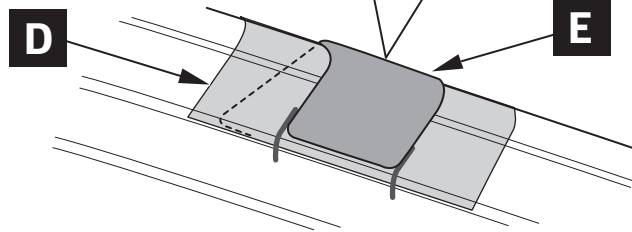
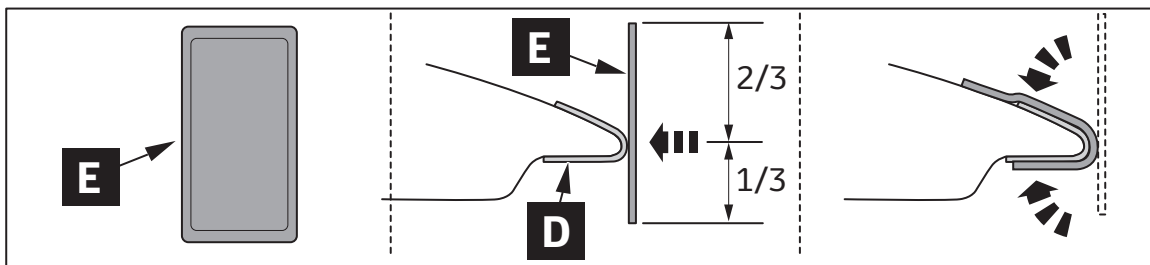

7

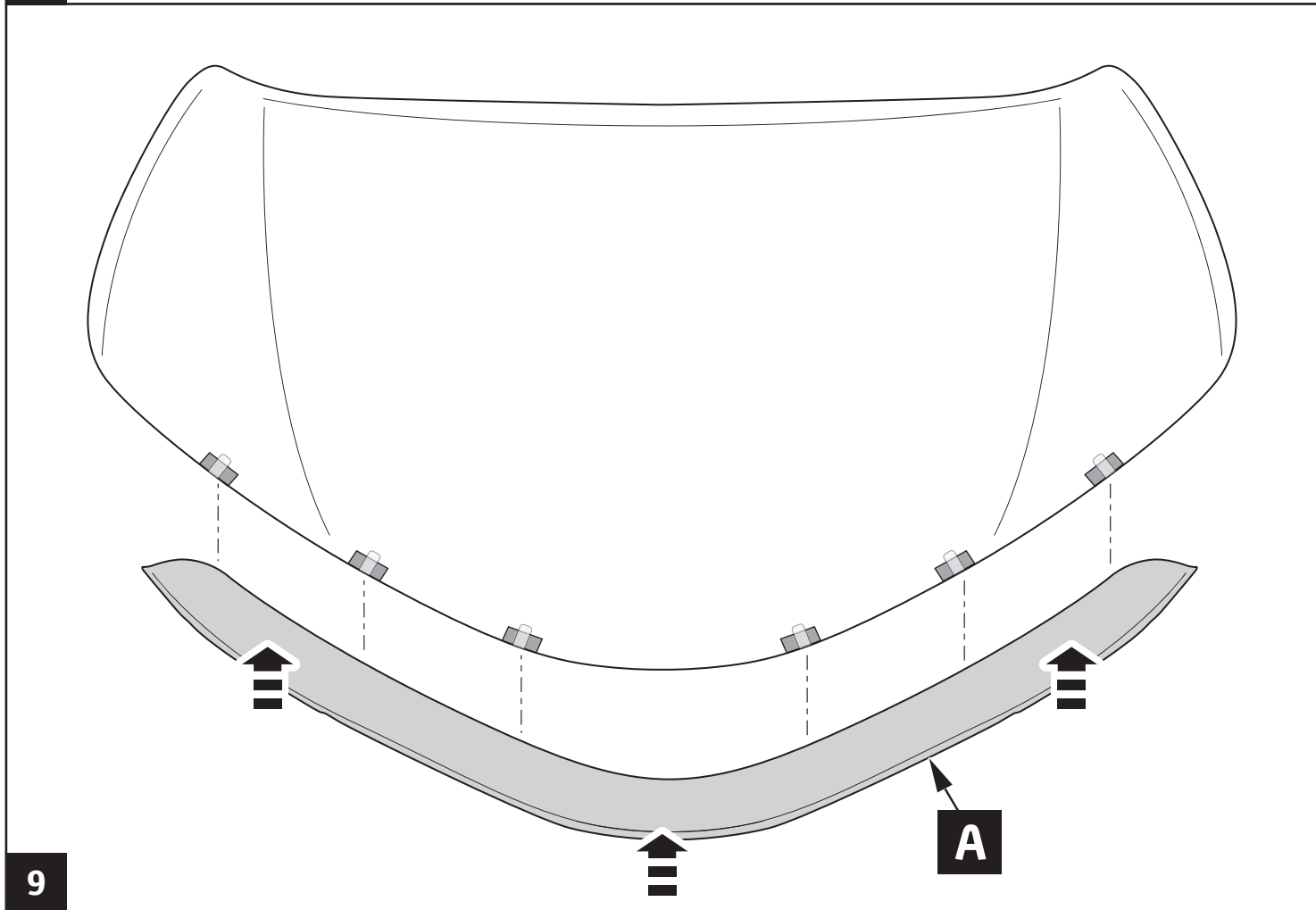
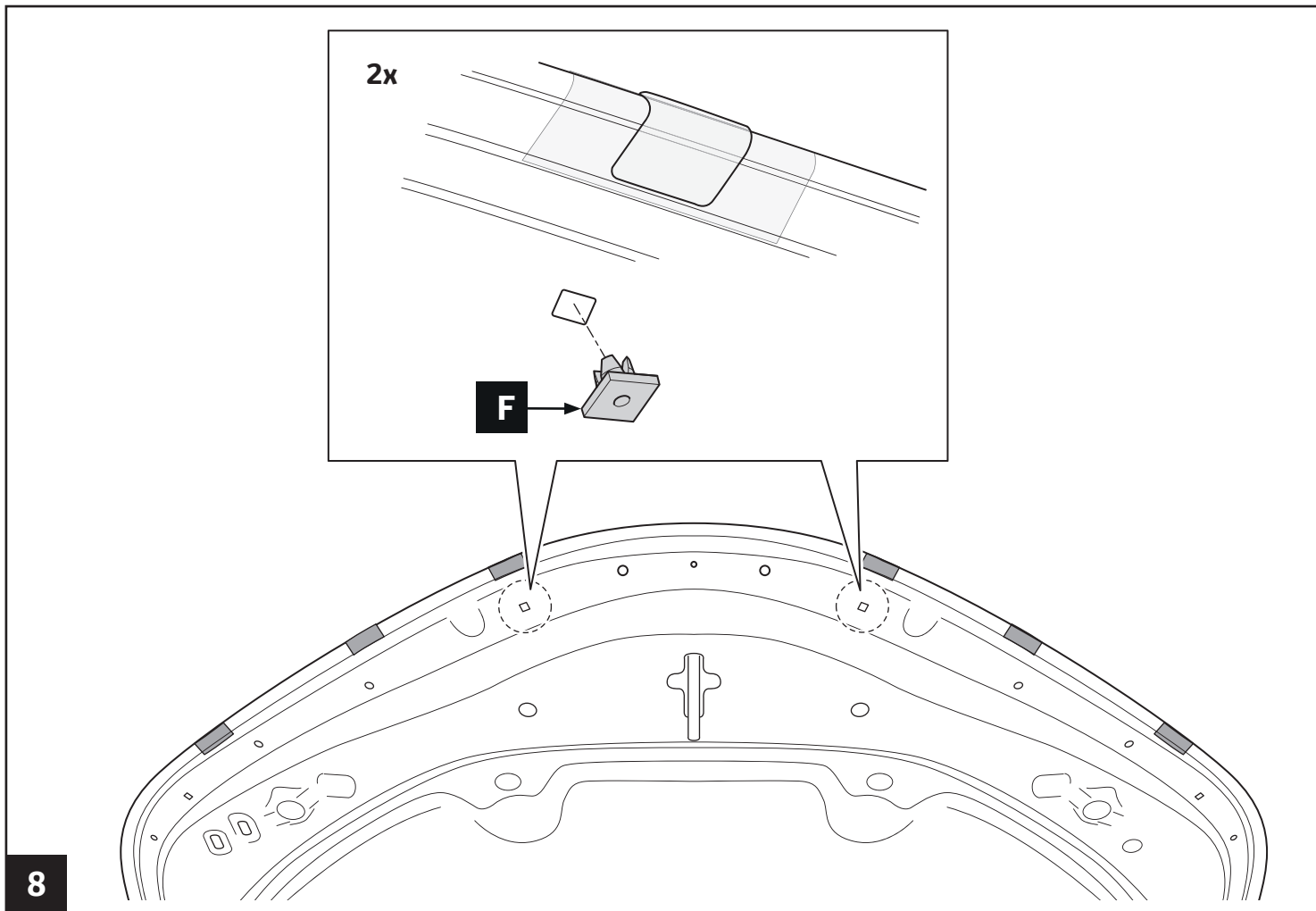

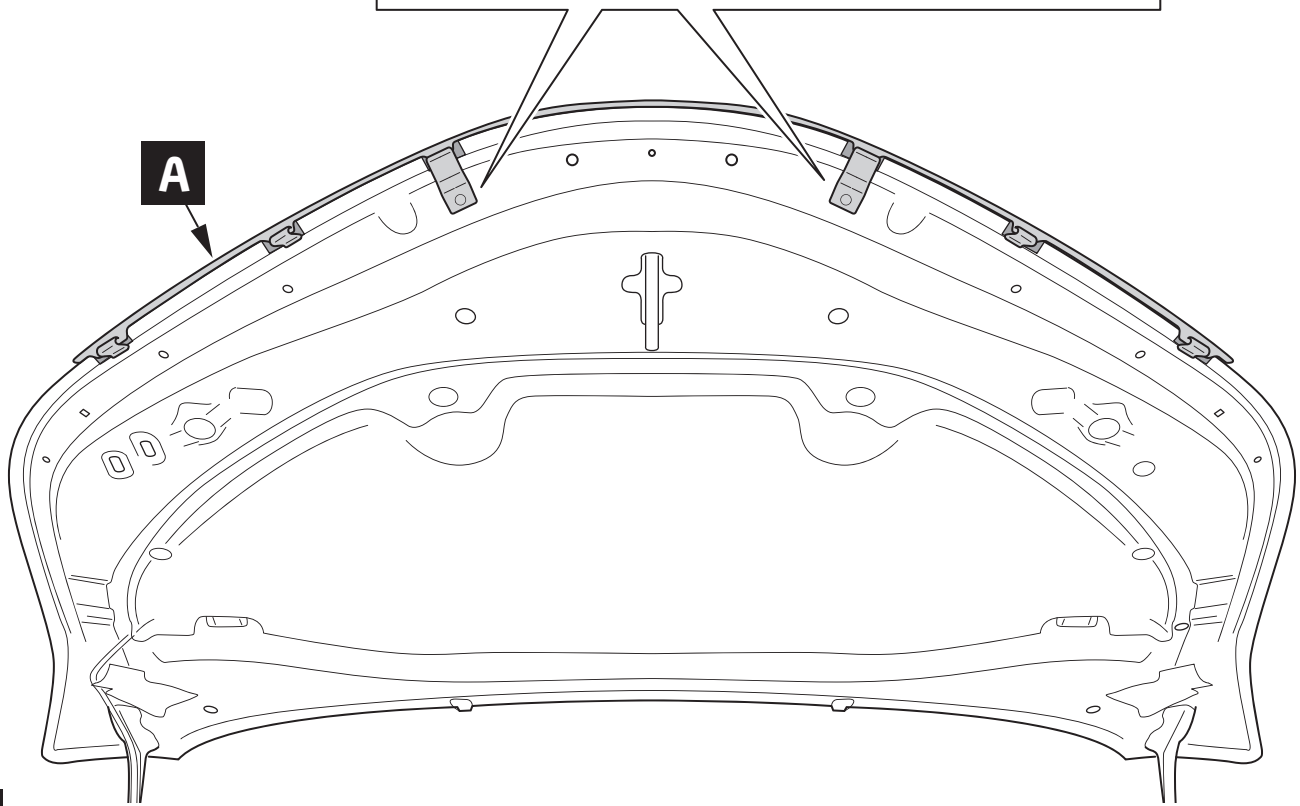
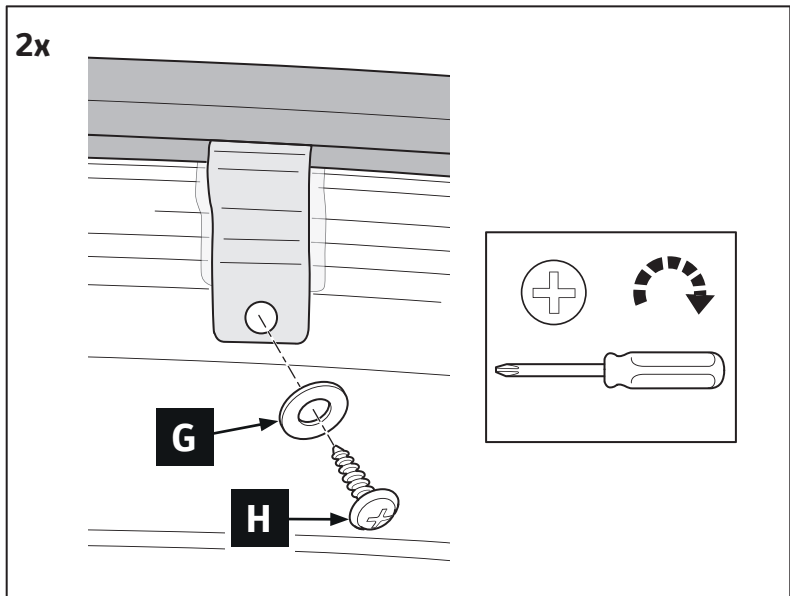

10

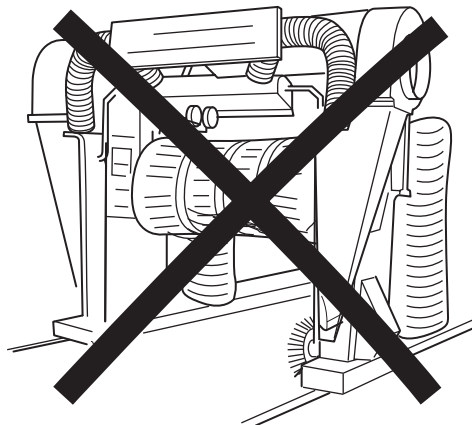

CHECK SHEET



TOYOTA

Model / Year

**Toyota C-HR
2016/10**

Hood Protector

VIN n°

ALWAYS A
BETTER WAY

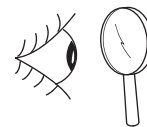
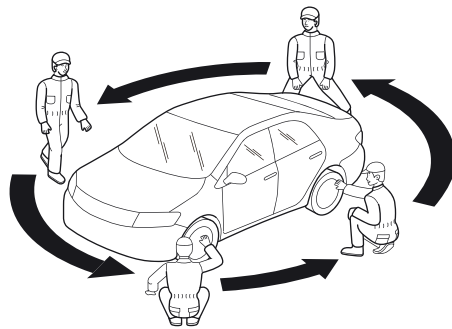
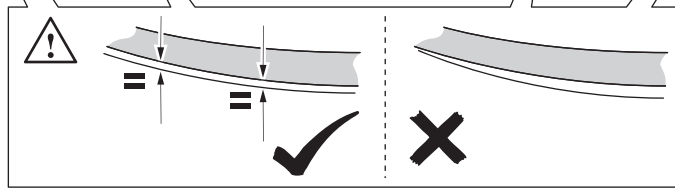
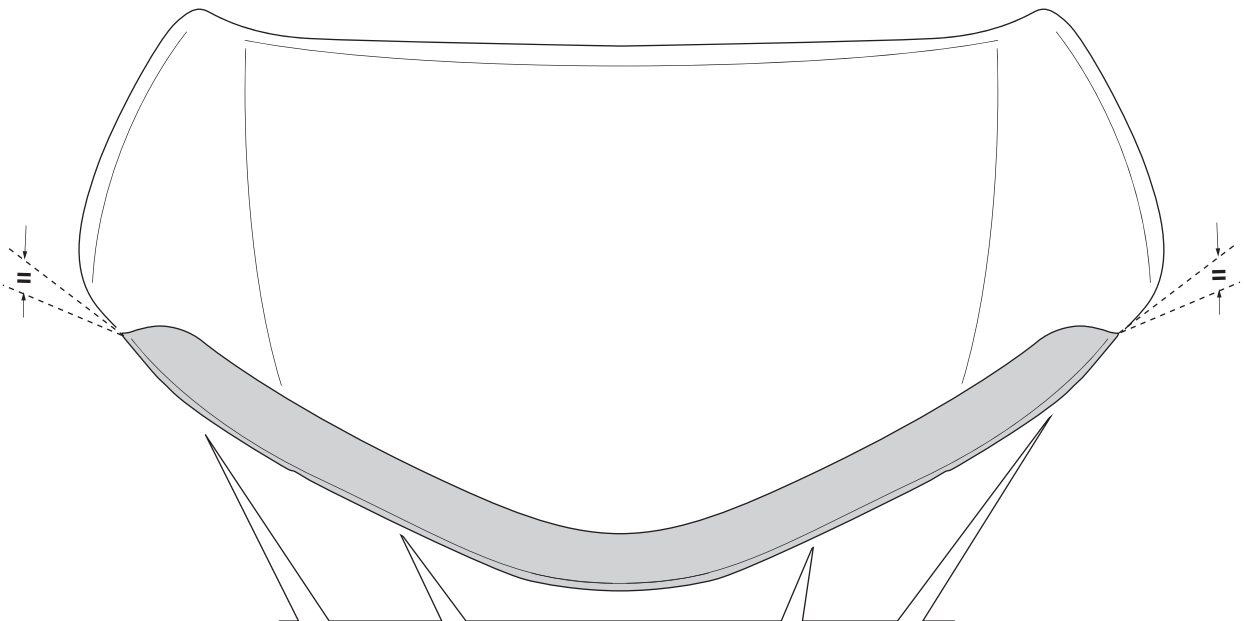
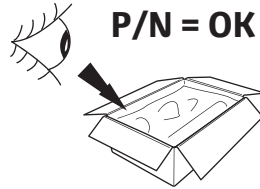

= OK

Installation Date:

. . / . . /

Technician Name & Signature:

Stamp: