

AYGO X

Side Mouldings

Installation Instructions

Model year: As from 2021/09

Vehicle code: KGB70*-AH**KW

Part number: PW170-0H100

Manual reference number: AIM 006 095-1

**Latest Version
SCAN HERE**



CLICK TO NAVIGATE

REVISION RECORD



Page

3

KIT CONTENT



Page

4

TOOLS



Page

4

CONSUMABLES



Page

4

PERSONAL PROTECTION EQUIPMENT



Page

4

USEFUL GENERAL MANUALS



Page

5

TAPE PARTS



Page

5

GENERAL



Info



Page

5

INSTALLATION INSTRUCTIONS



Pages

6 - 12

INFORMATION



Page

13

CHECK SHEET



CHECK SHEET



Pages

14 - 15

THINK BEFORE YOU PRINT



**ONLINE = LATEST VERSION
GO DIGITAL!**

Revision Record

Rev. No.	Date	Page	Step	Remarks
1	27.11.2023			Updated to latest Standards.

KIT CONTENT

PW170-0H100



PW170-0H102

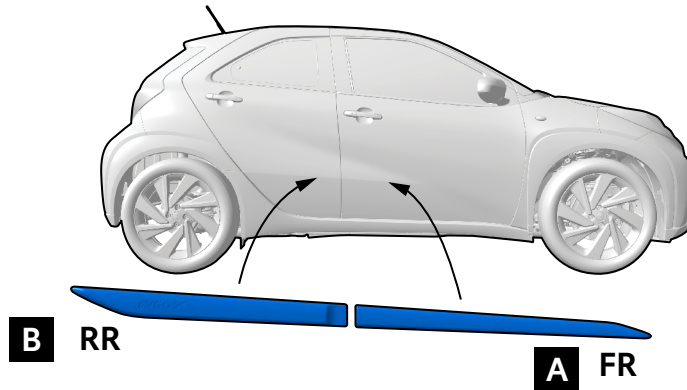

PW170-0H101

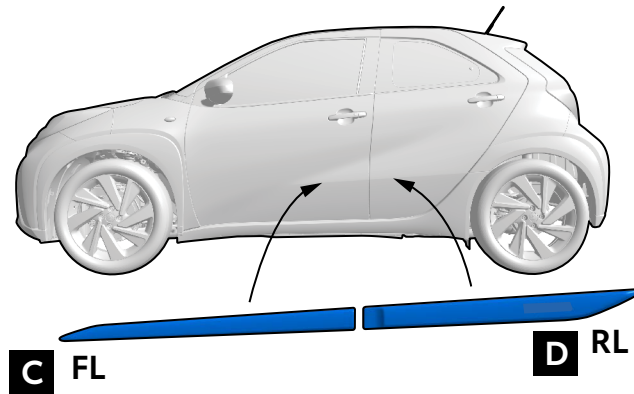

TOOLS

PRESSURE ROLLER	TAPE MEASURE	TEMPERATURE SENSOR	RULER

CONSUMABLES

MASKING TAPE	CLEANER / DEGREASER			

PERSONAL PROTECTION EQUIPMENT

PROTECTIVE GLOVES				

USEFUL GENERAL MANUALS

CLEANER / DEGREASER



Latest Version
SCAN HERE

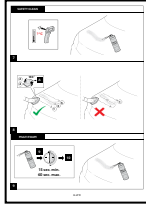

SYMBOLS



Latest Version
SCAN HERE



INSTALLATION CONDITIONS



Latest Version
SCAN HERE

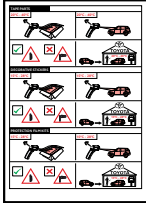

TAPE PARTS

20°C - 40°C

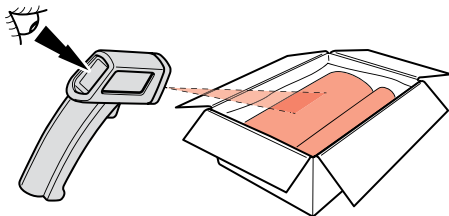

20°C - 40°C

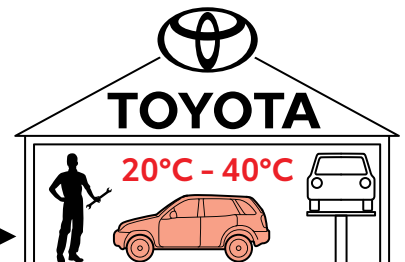
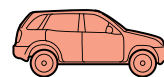
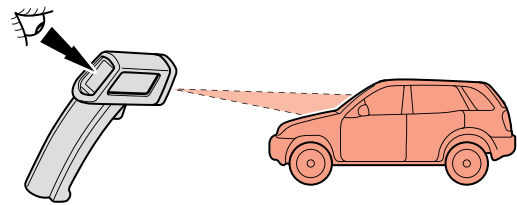

GENERAL



Material Safety Data Sheet



Technical Data Sheet

INSTALLATION INSTRUCTIONS

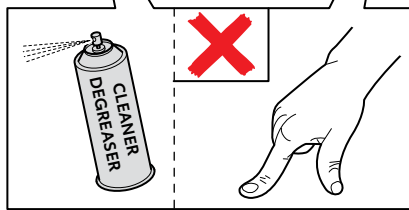
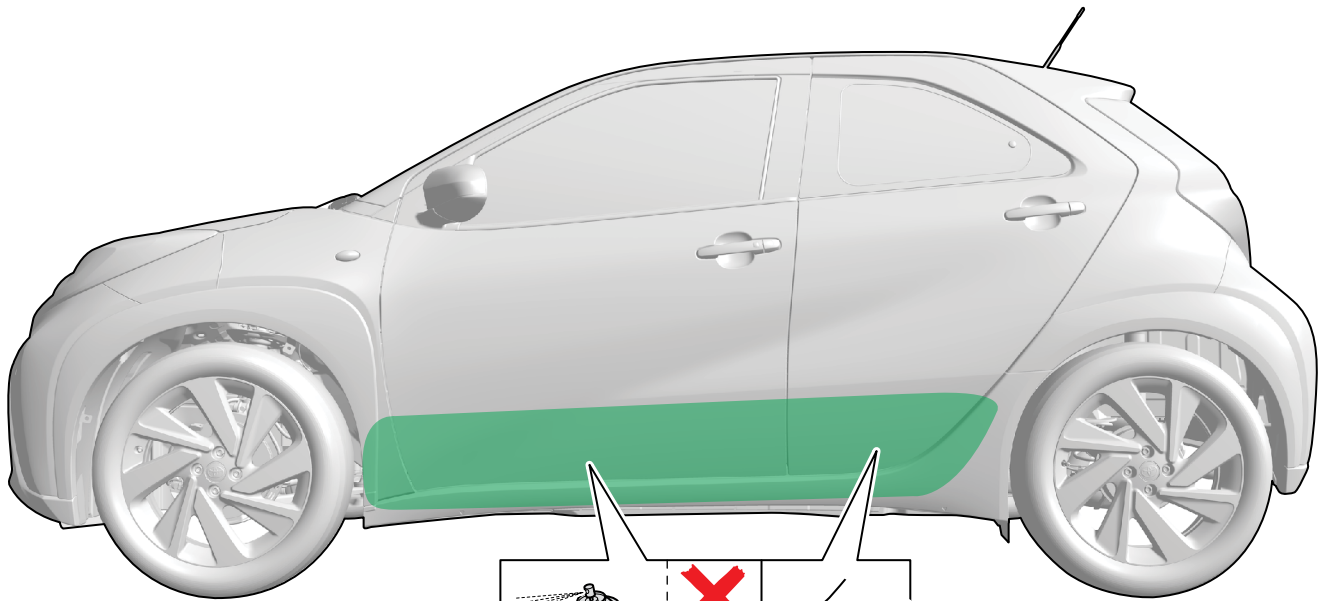

1

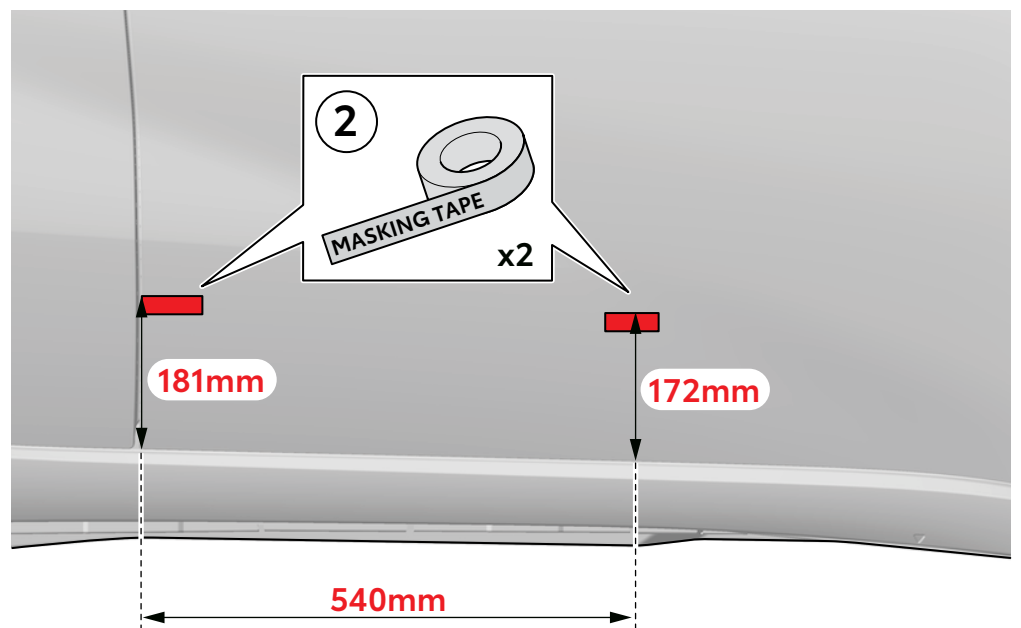
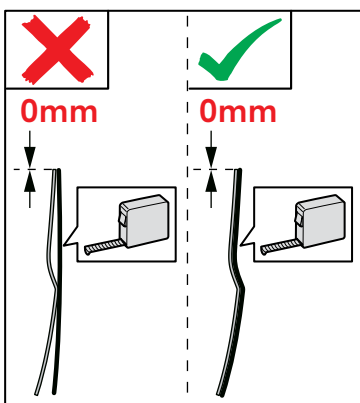
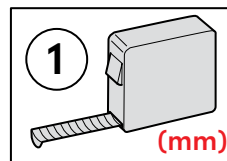
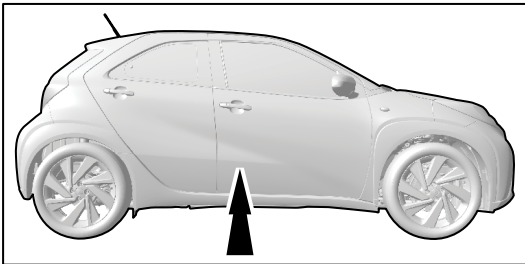

2

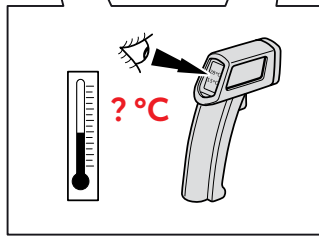
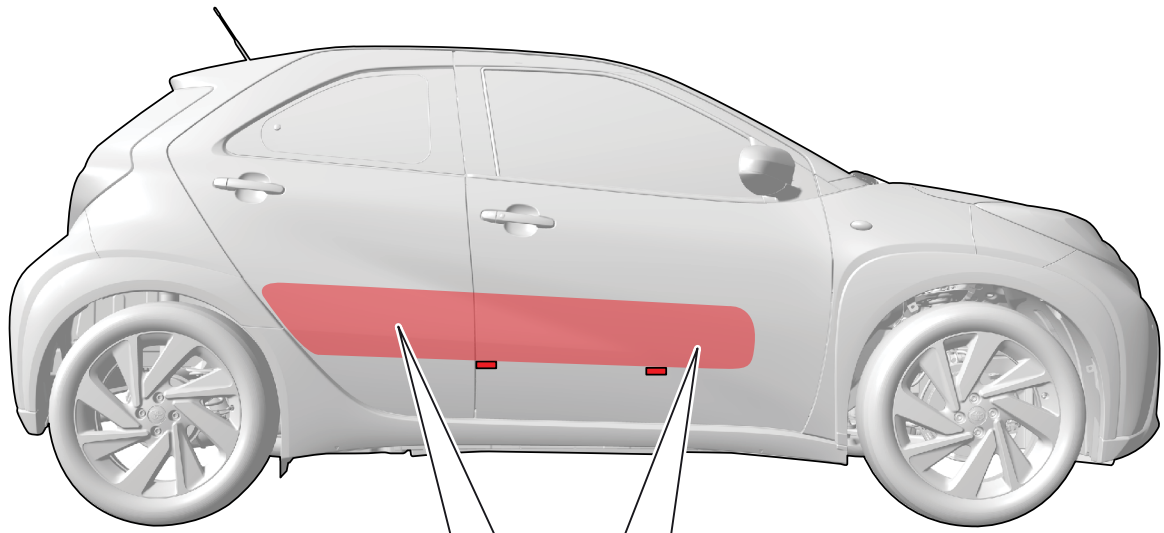

3

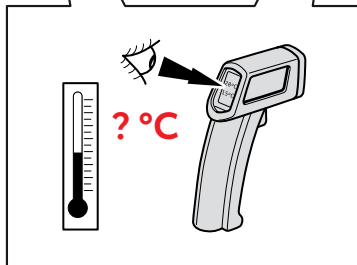
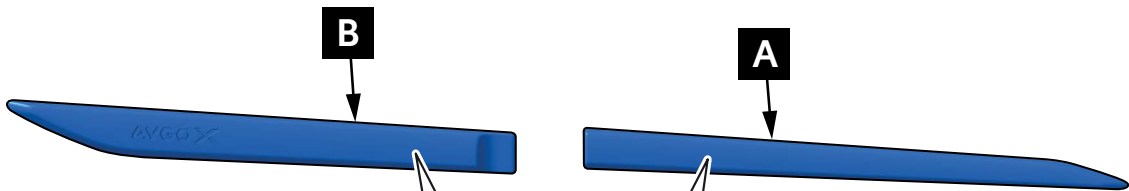

4

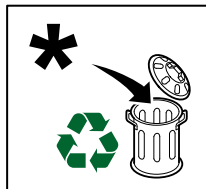
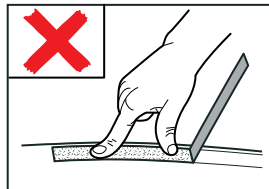
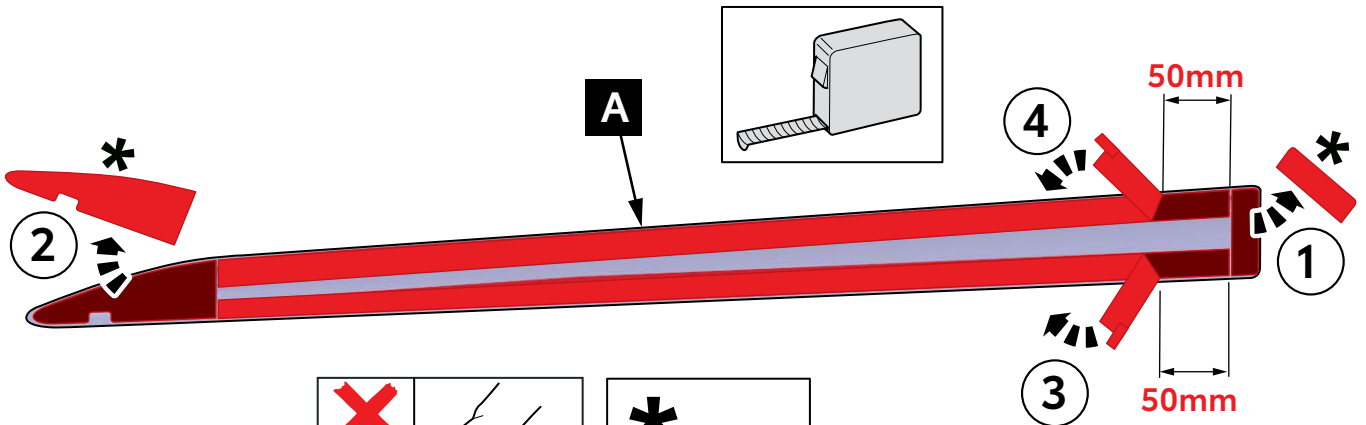

5

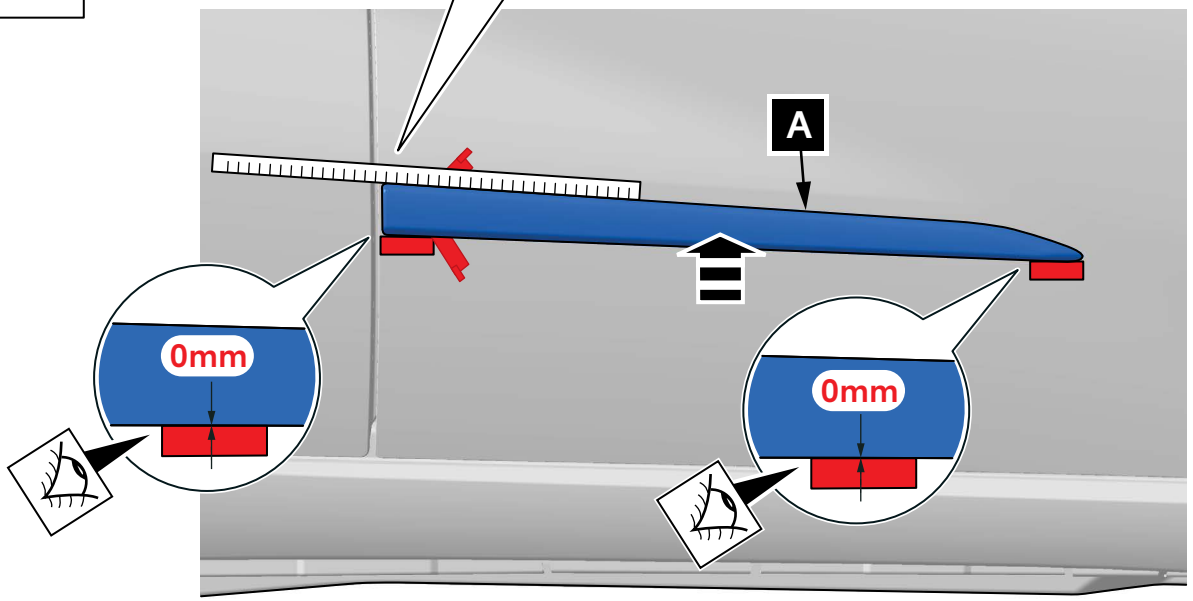
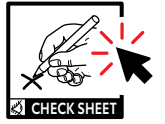
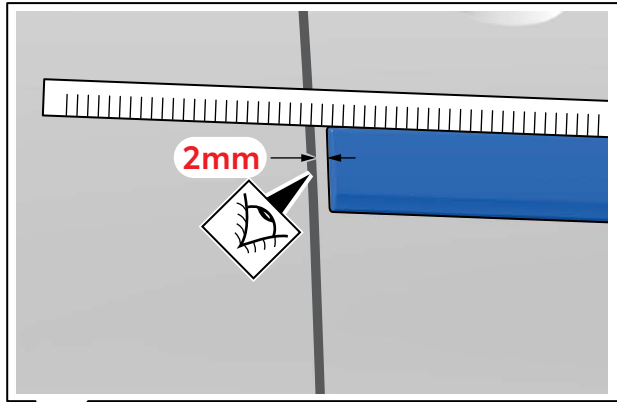
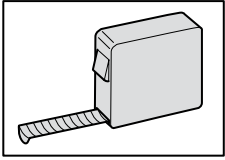
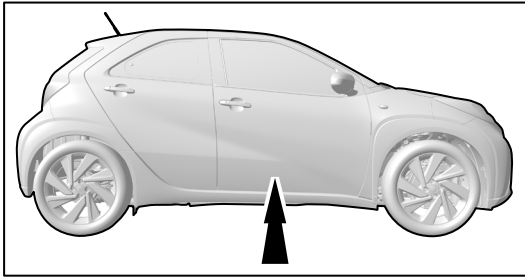

6

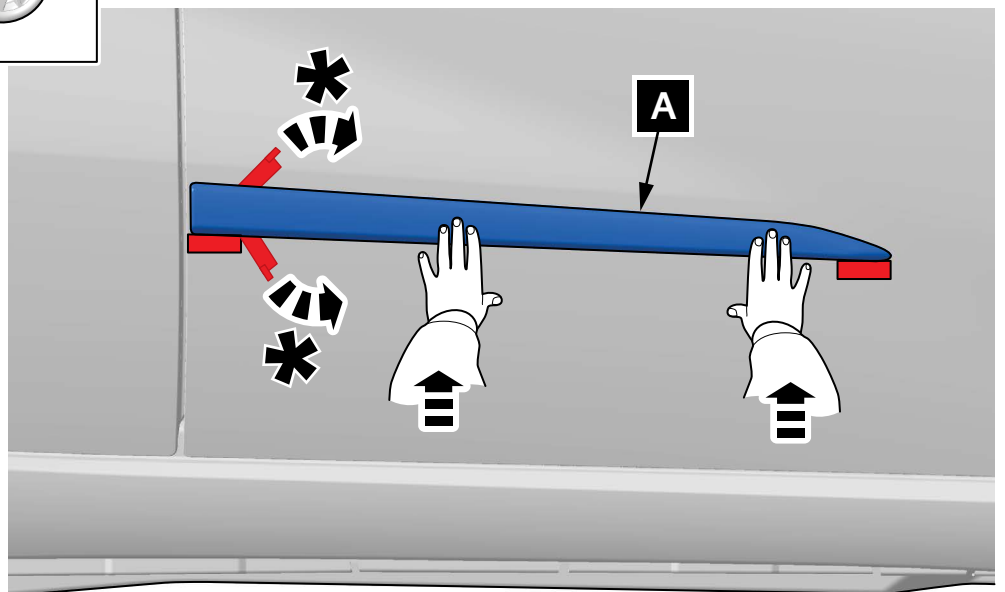
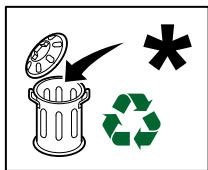
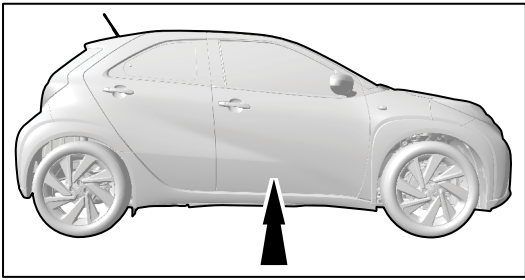

7

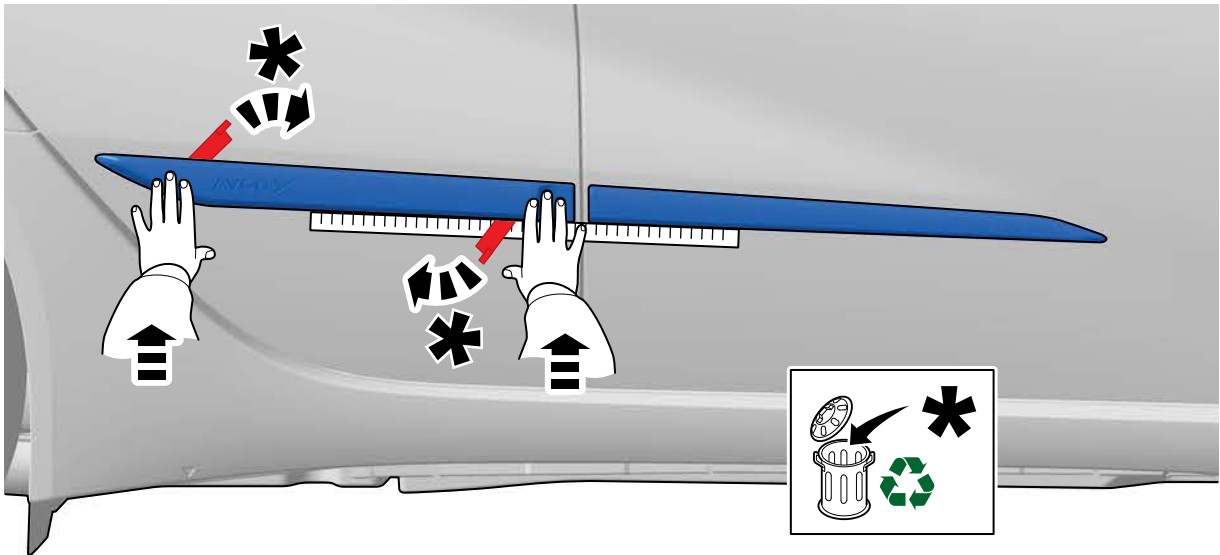

10

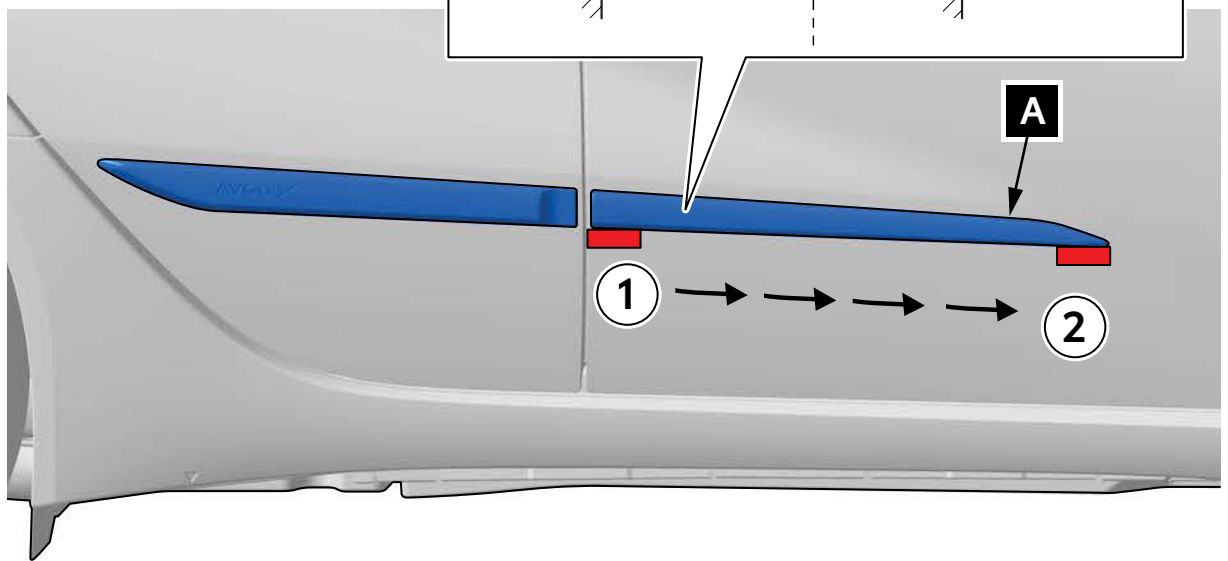
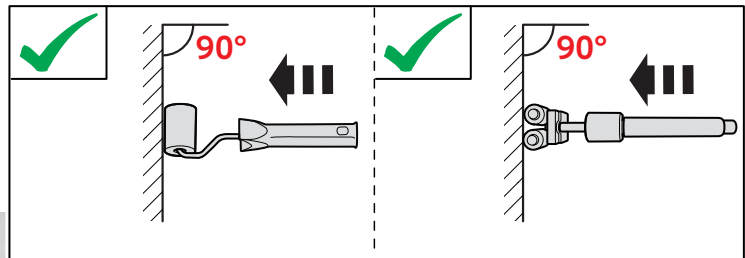
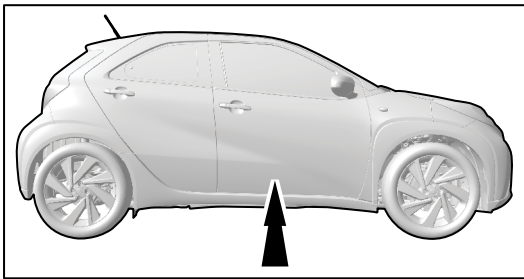

11

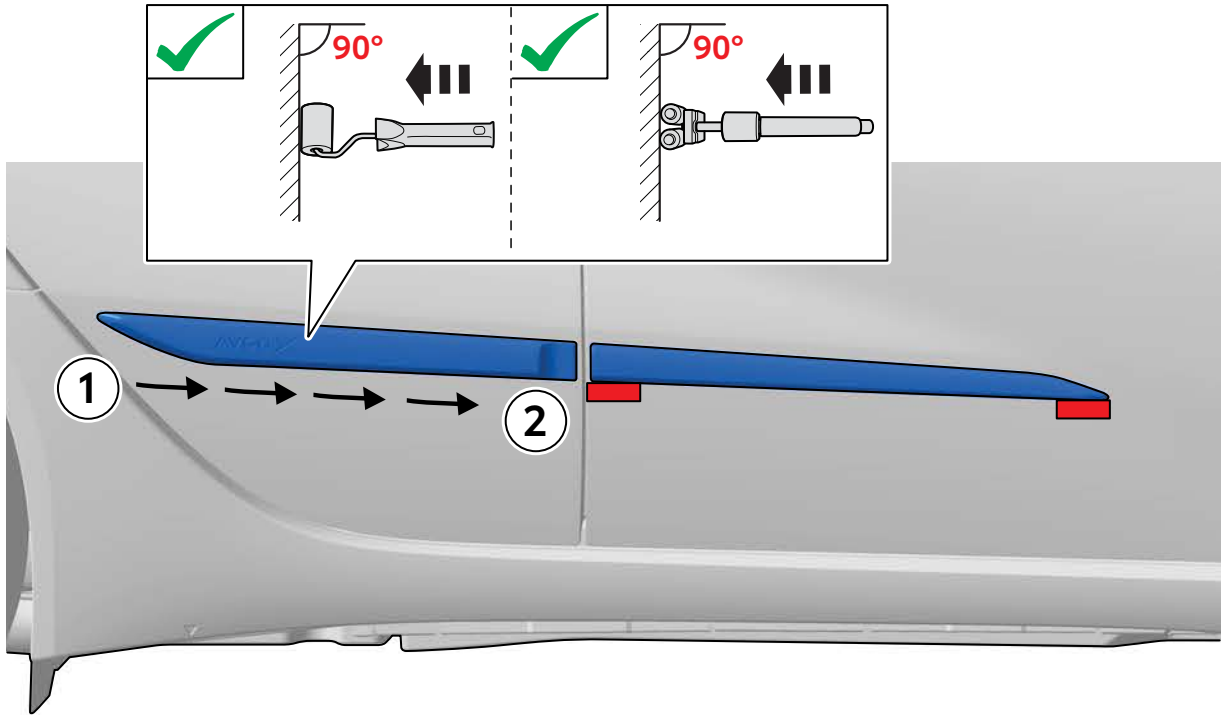

12

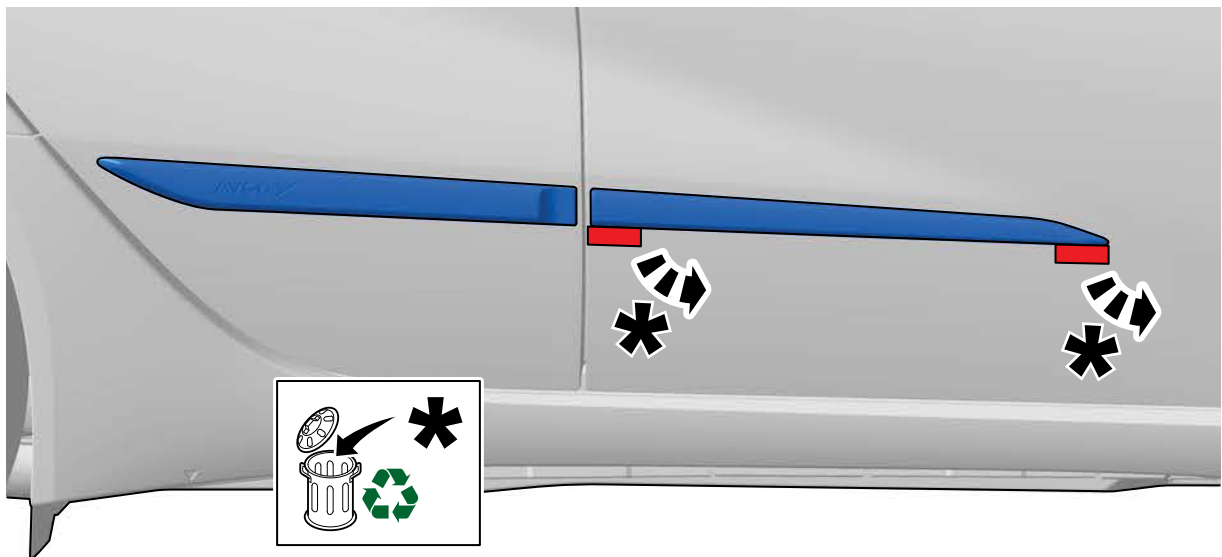

13

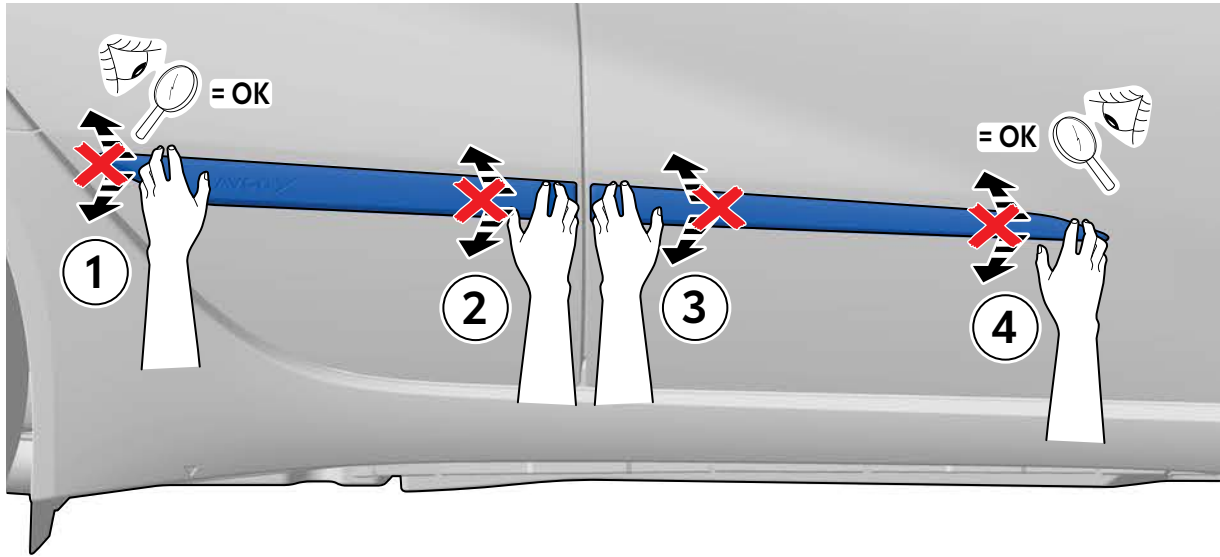

14

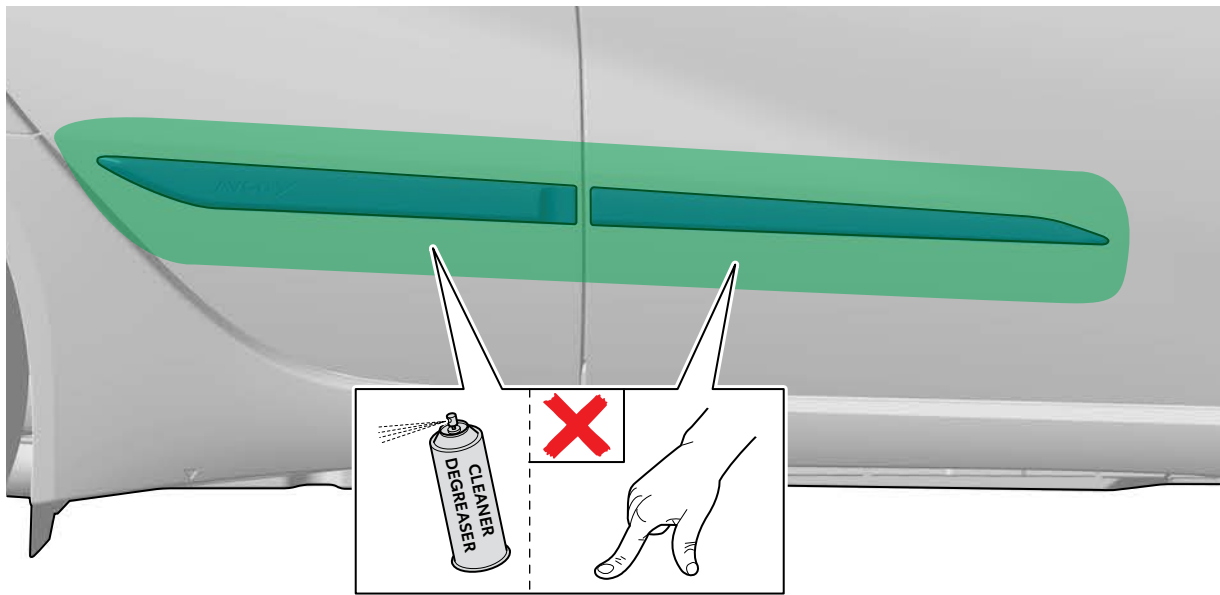

15

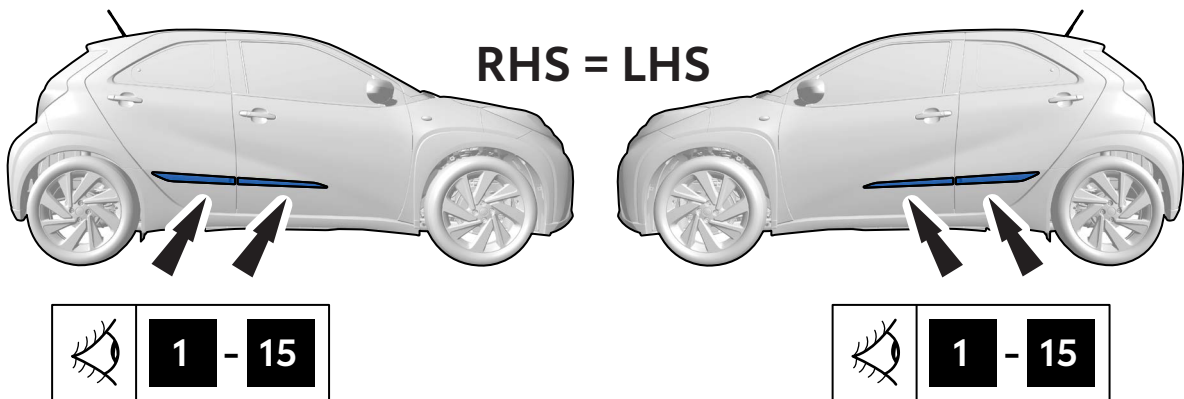

16

INFORMATION

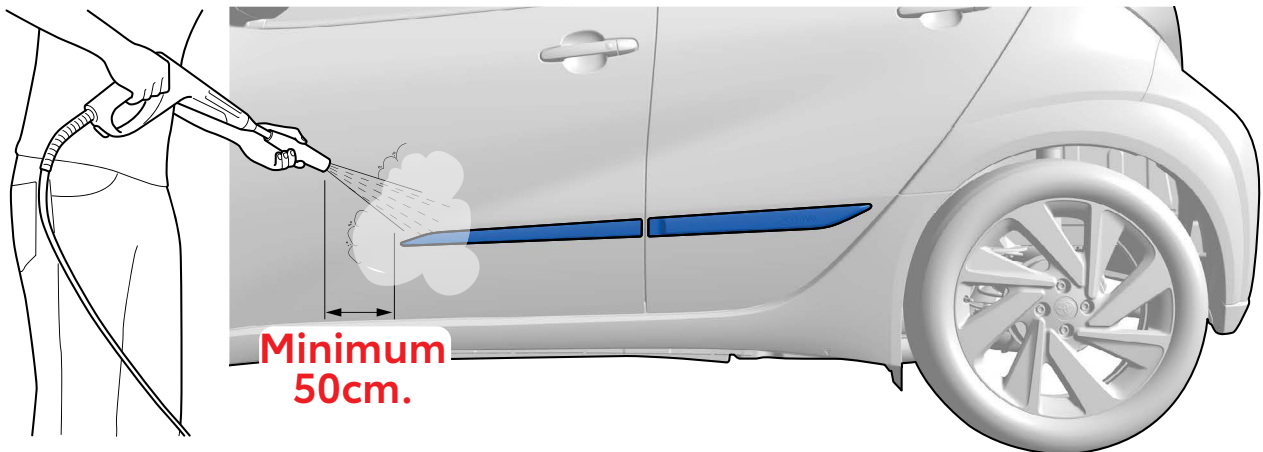
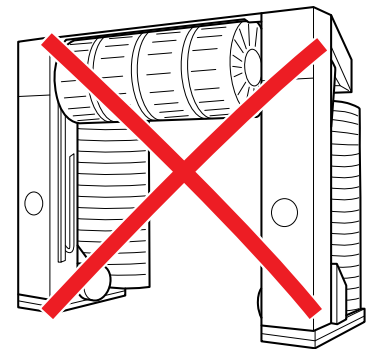
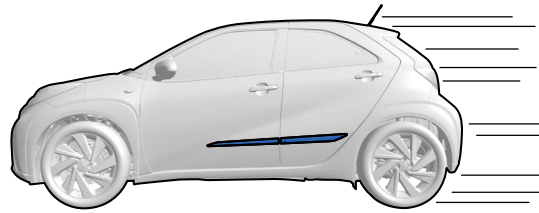
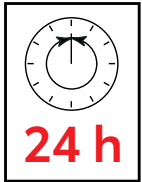

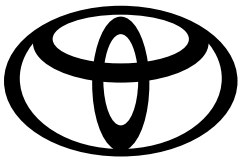

CHECK SHEET

Page 1 of 2

Model/Year

AYGO X
As from 2021/09

Side Mouldings

VINn°

DURING INSTALLATION

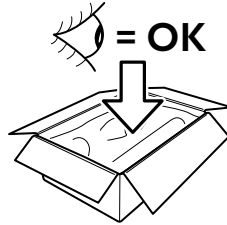

P/N = OK



1



AFTER INSTALLATION

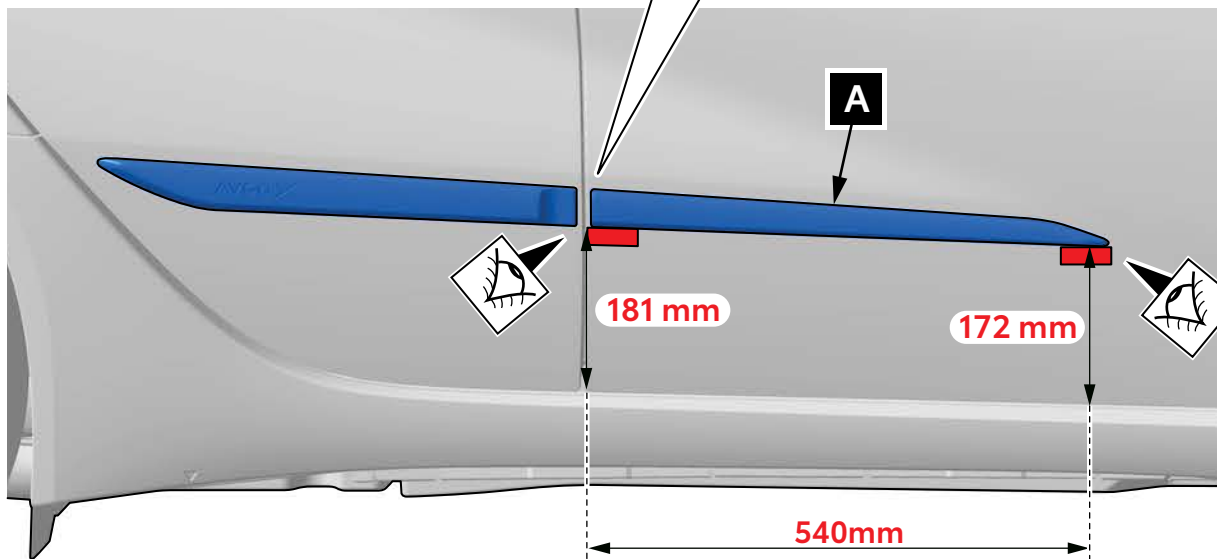
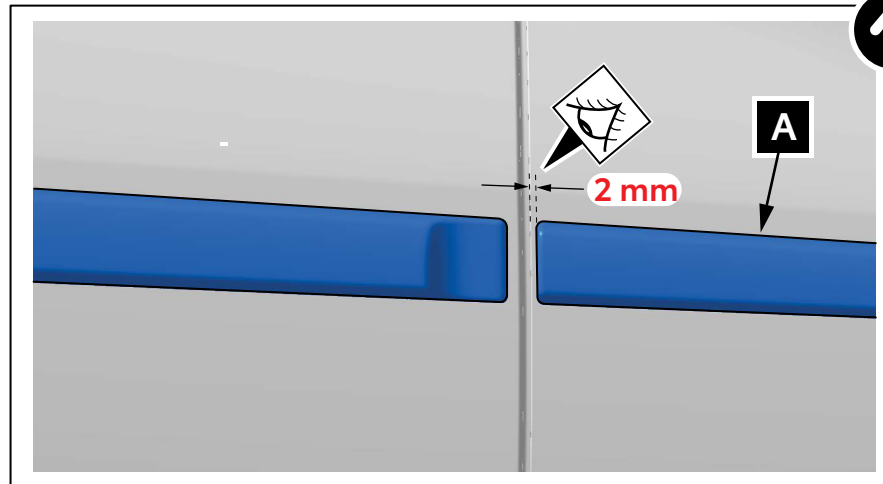

1

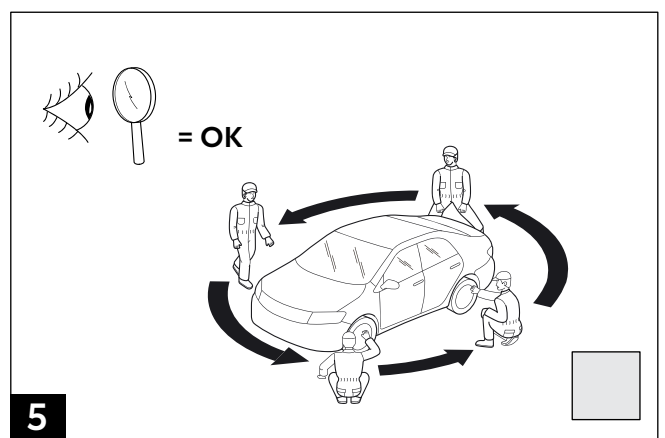
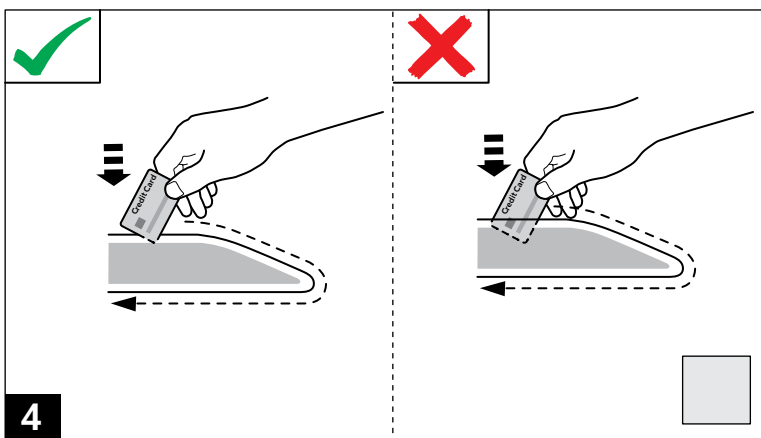
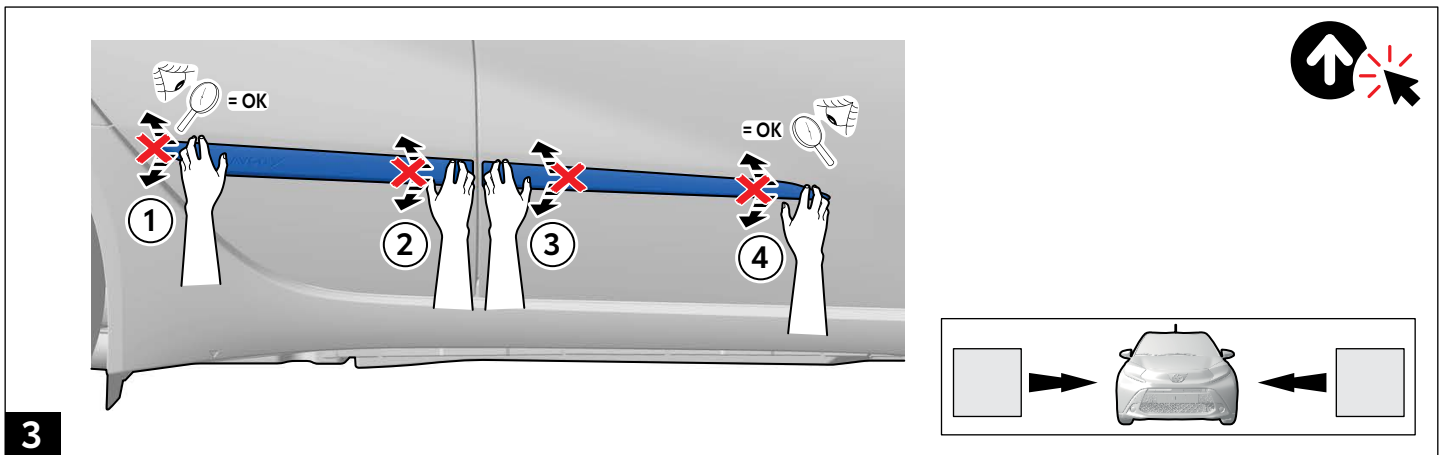
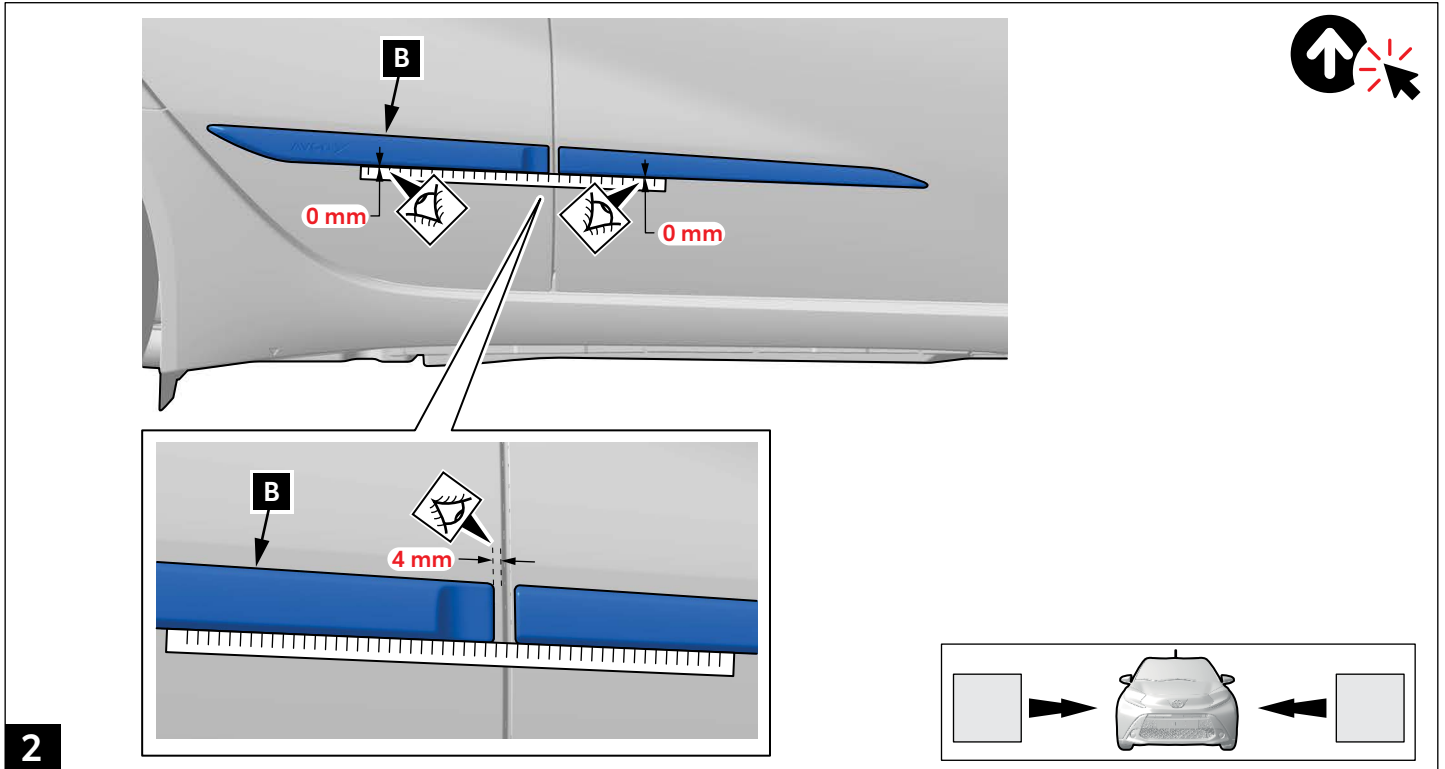

Installation Date:

... / ... / ...

Technician Name & Signature:

Stamp: