

# AYGO X

## Spare Tyre - Trunk Assembly

### Installation Instructions

Model year: As from 2022/03

Vehicle code: KGB70\*-AH\*\*KW

Part number:	51931-F4010	Wheel screw
	09150-F4010	Wrench
	09111-F4010	Jack
	09113-F4010	Handle - Jack
	64995-0H010	Box Deck Floor - RH
	64993-0H040	Box Deck Floor- RR
	64997-0H010	Box Deck Floor - LH
	09126-0H020	Temporary Spare Wheel

Manual reference number: AIM 006 142-0

# Revision record

Rev. No.	Date	Page	Step	Remarks

## KIT CONTENT



64997-0H010  
Box Deck Floor - LH



**A**

x1

64993-0H040  
Box Deck Floor- RR

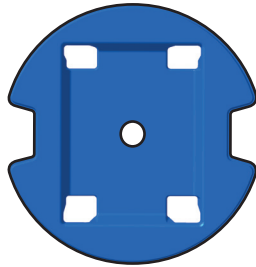

**B**

x1

64995-0H010  
Box Deck Floor - RH

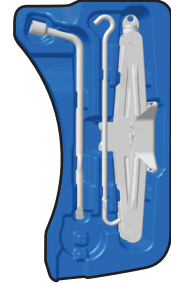

**C**

x1

09150-F4010  
Wrench

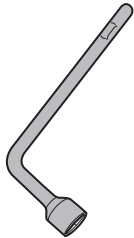

**D**

x1

09111-F4010  
Jack

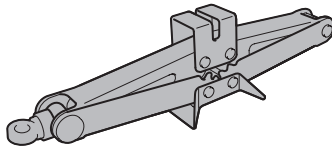

**E**

x1

09113-F4010  
Handle - Jack

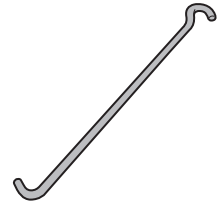

**F**

x1

09126-0H020  
Temporary Spare Wheel



**G**

x1

51931-F4010  
Wheel screw



**H**

x1

## TOOLS



# OVERVIEW

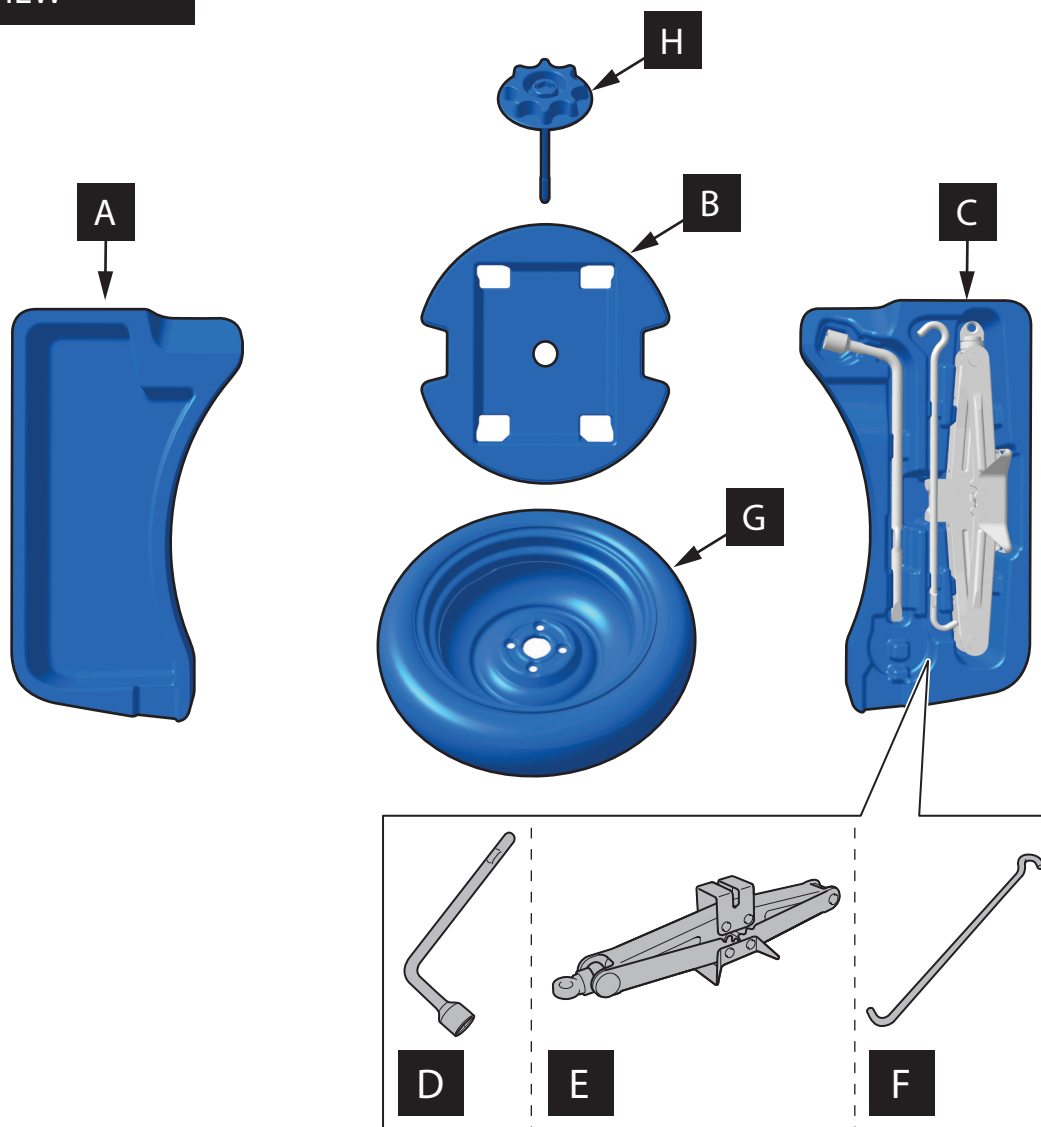

# INSTALLATION INSTRUCTIONS

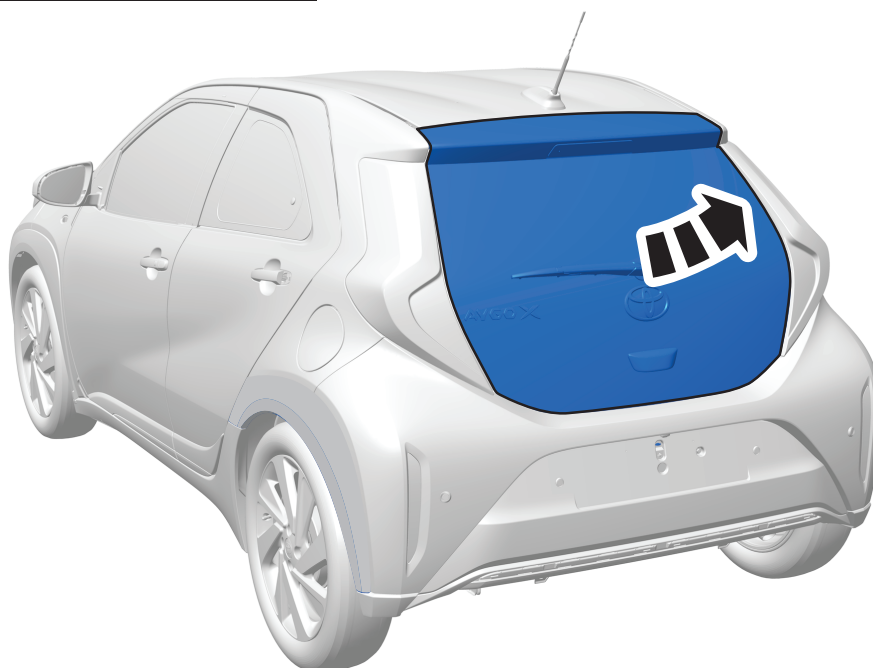

1

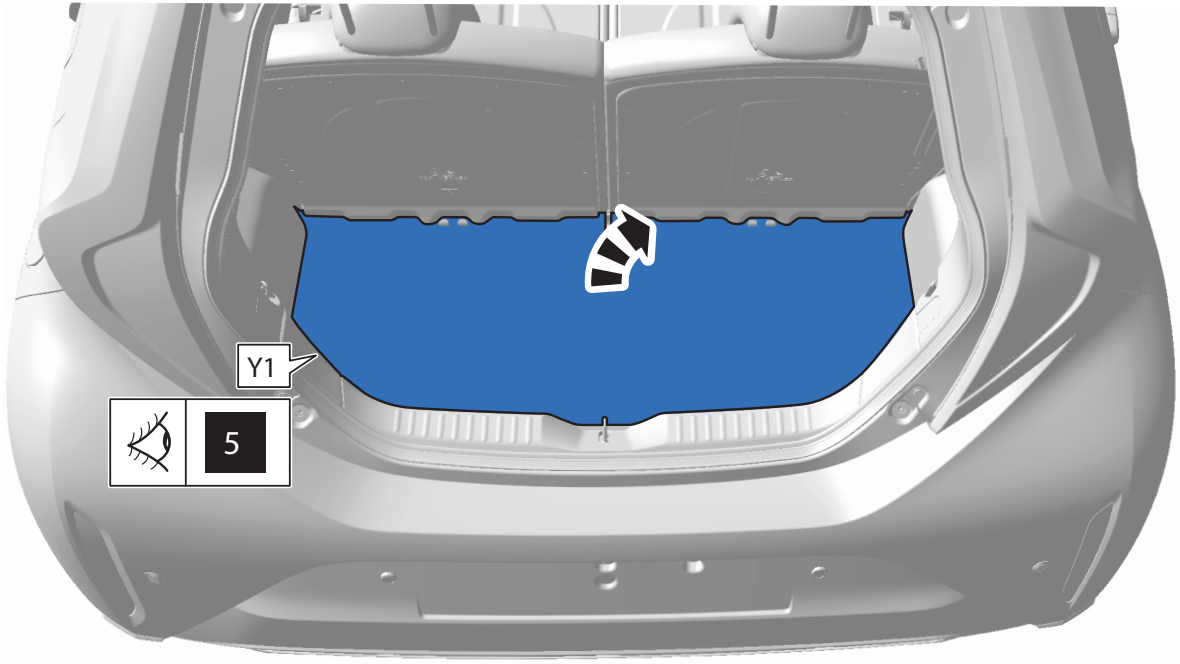

2

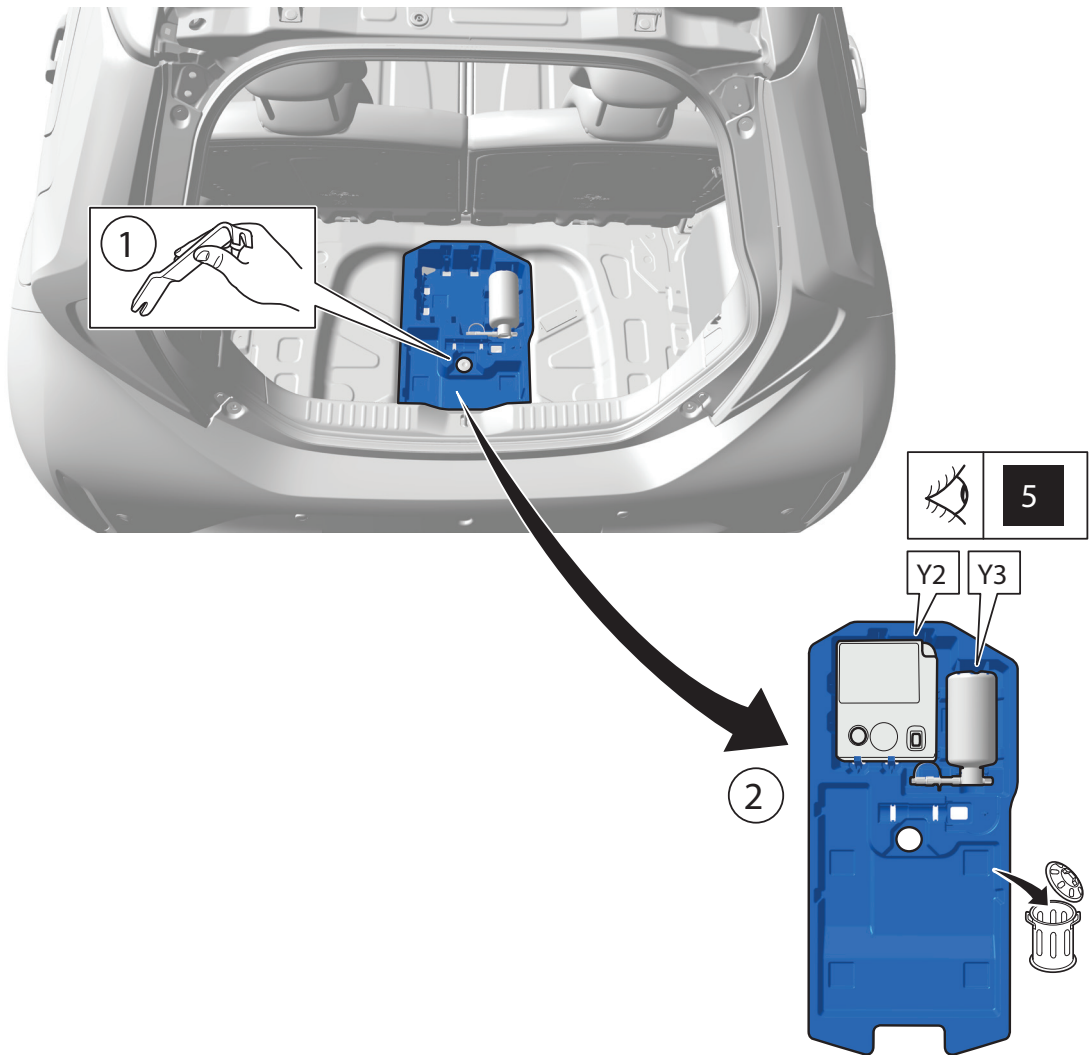

3

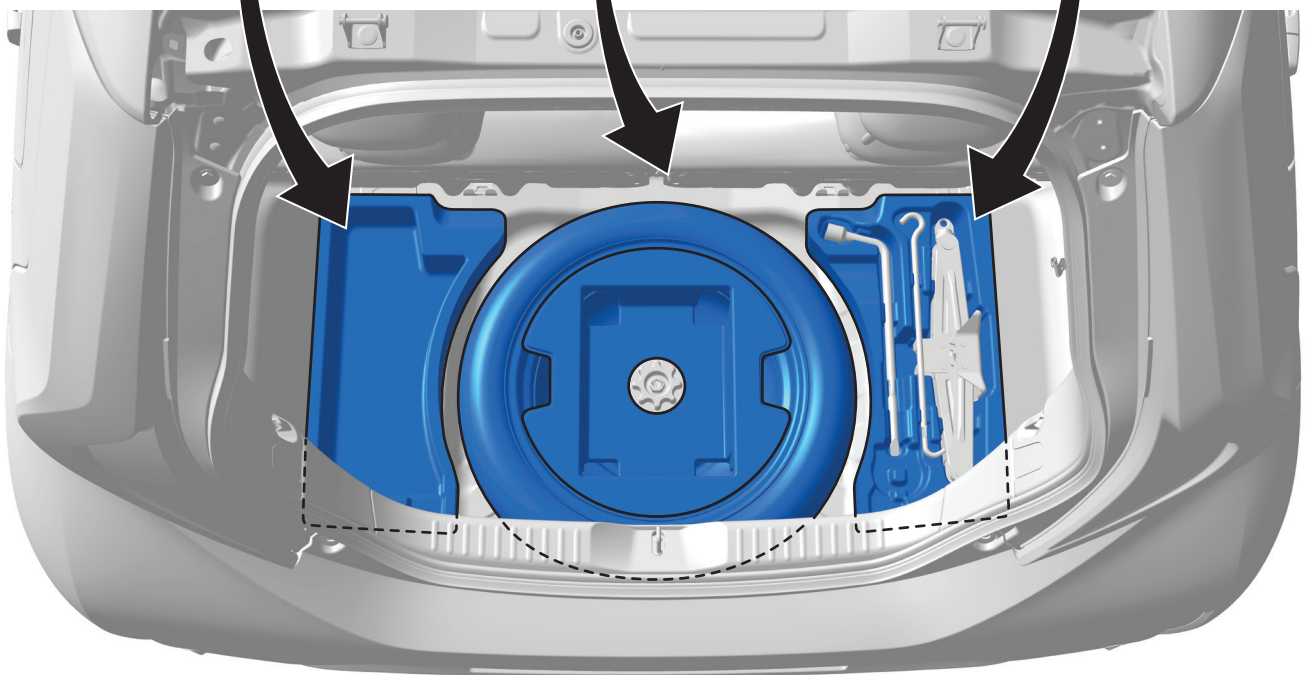
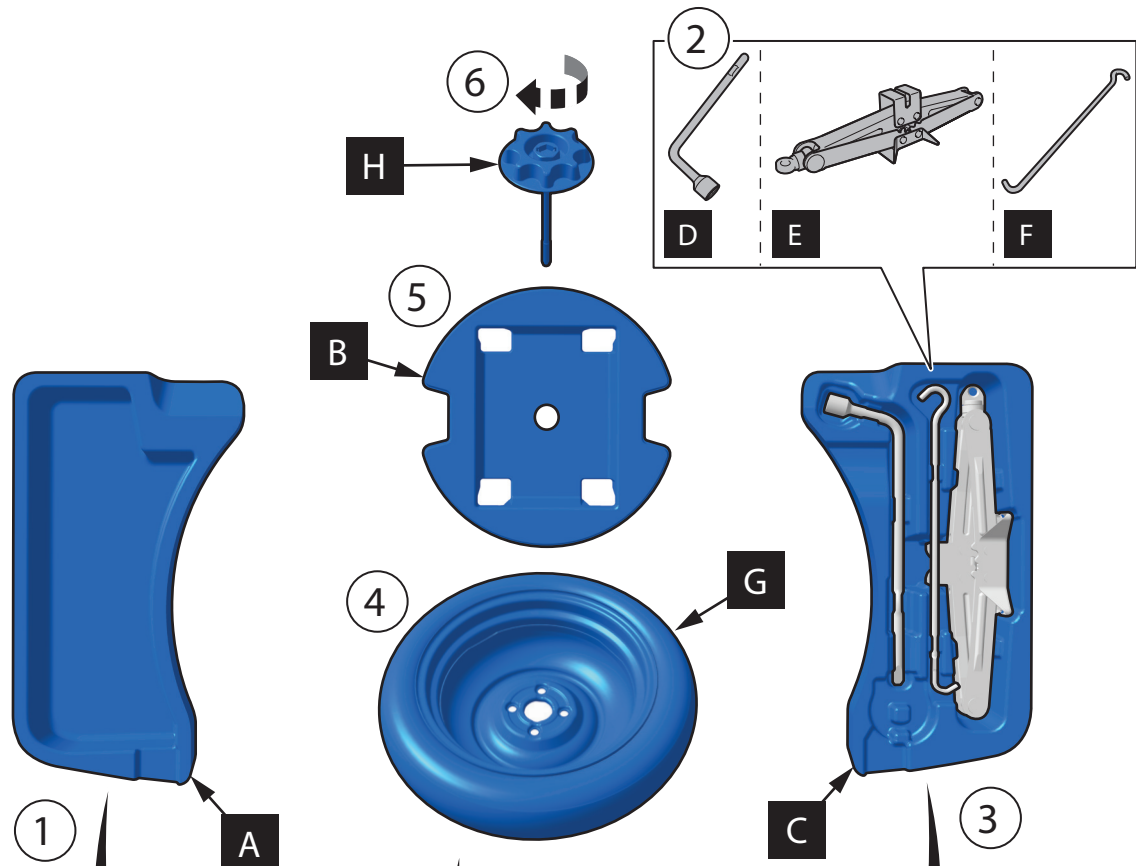

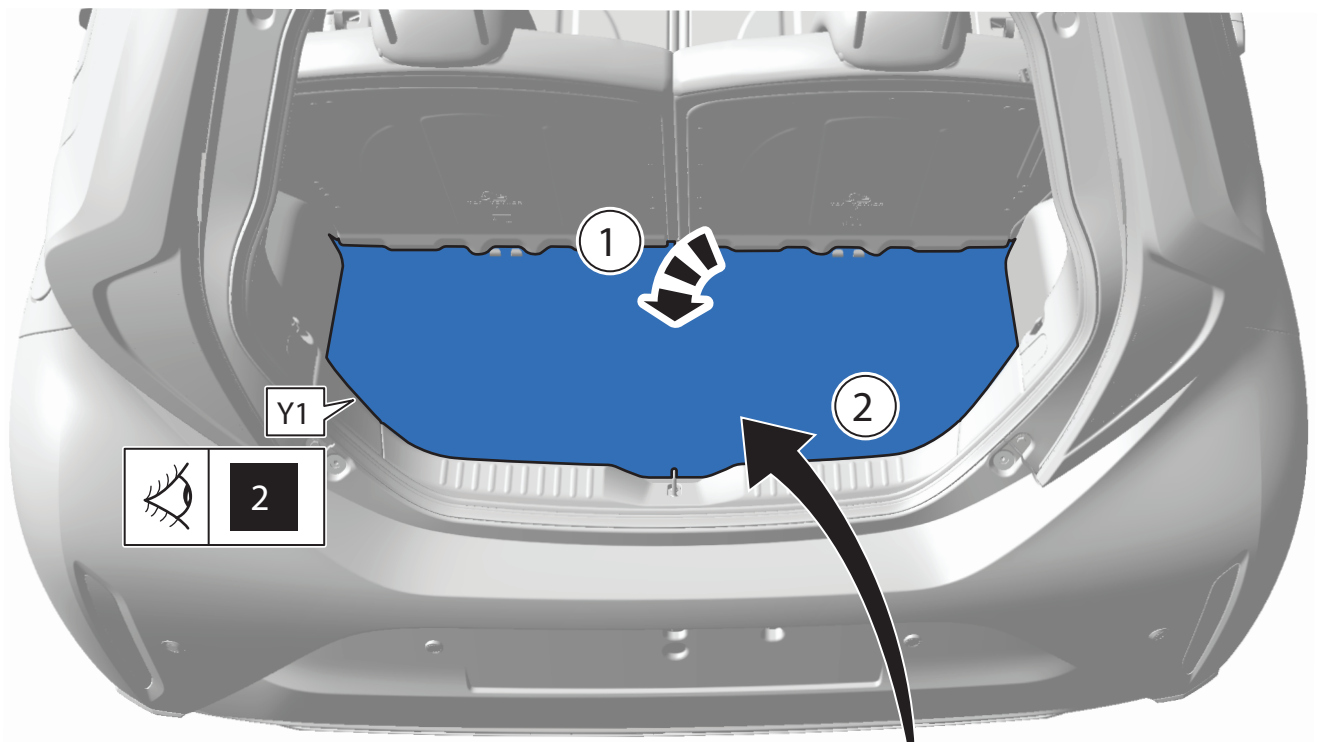

Y1

	2
---	---

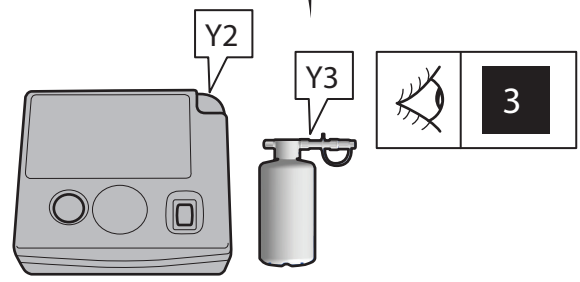

Y2

Y3

	3
---	---

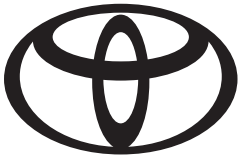

# CHECK SHEET

Page 1 of 2

Model/Year **AYGO X**  
As from 2022/03

Spare Tyre - Trunk Assembly

VINn°

## DURING INSTALLATION

**1**

 P/N = OK

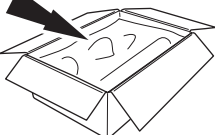

**2**

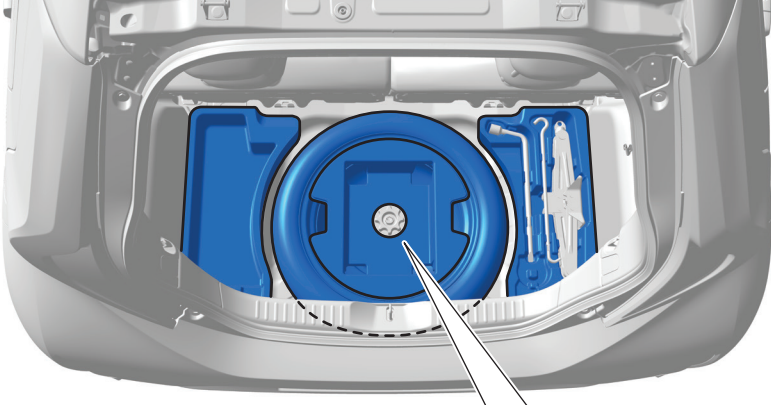

**G** **B** **H**

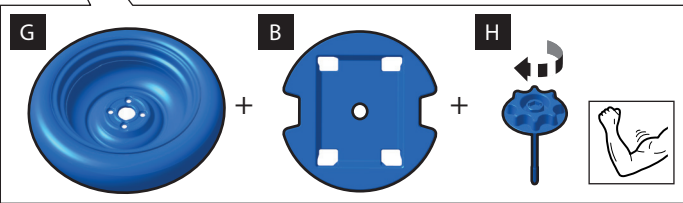

**3**

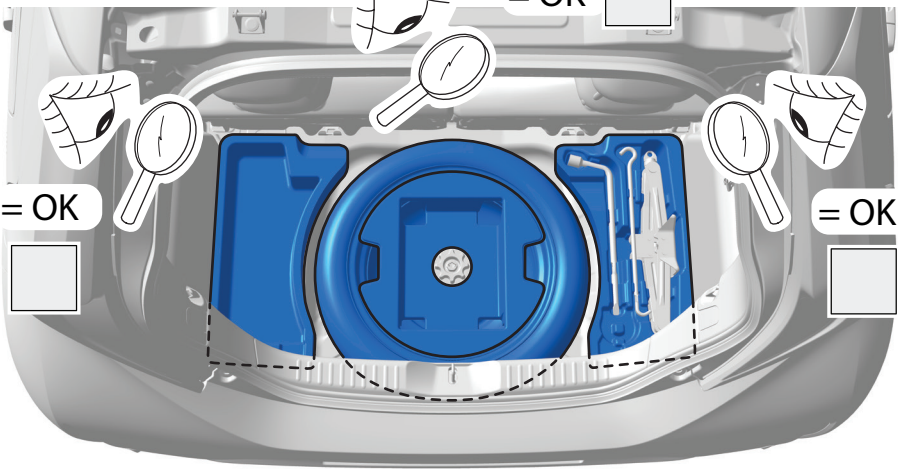

**= OK**

**= OK**

**= OK**

**= OK**

## DURING INSTALLATION

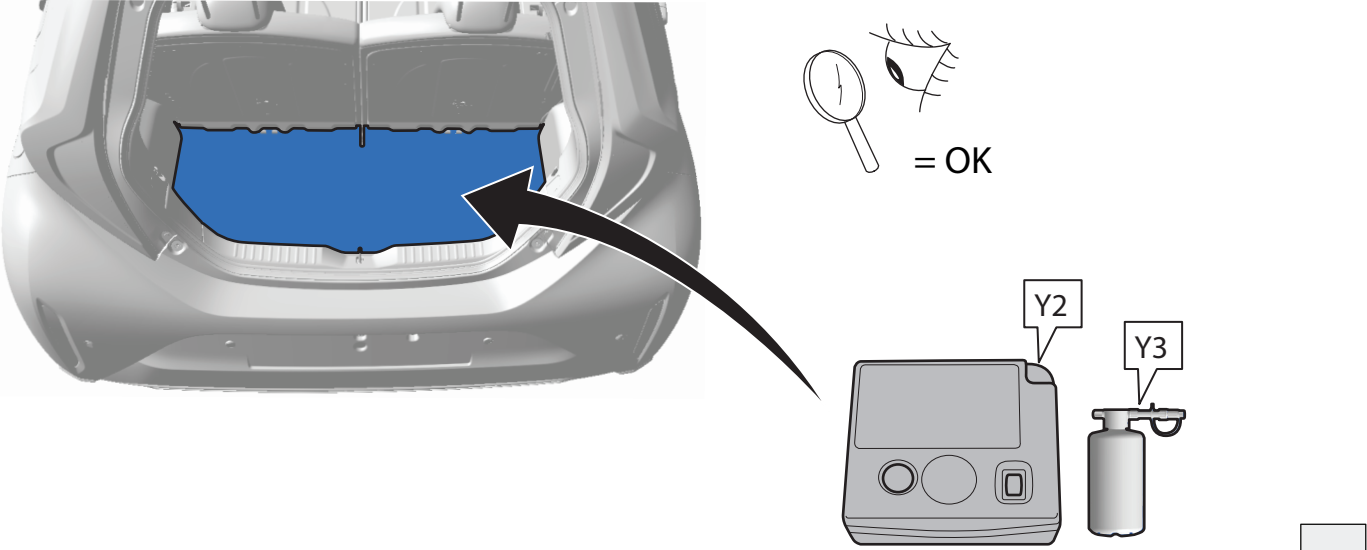

4

## AFTER INSTALLATION

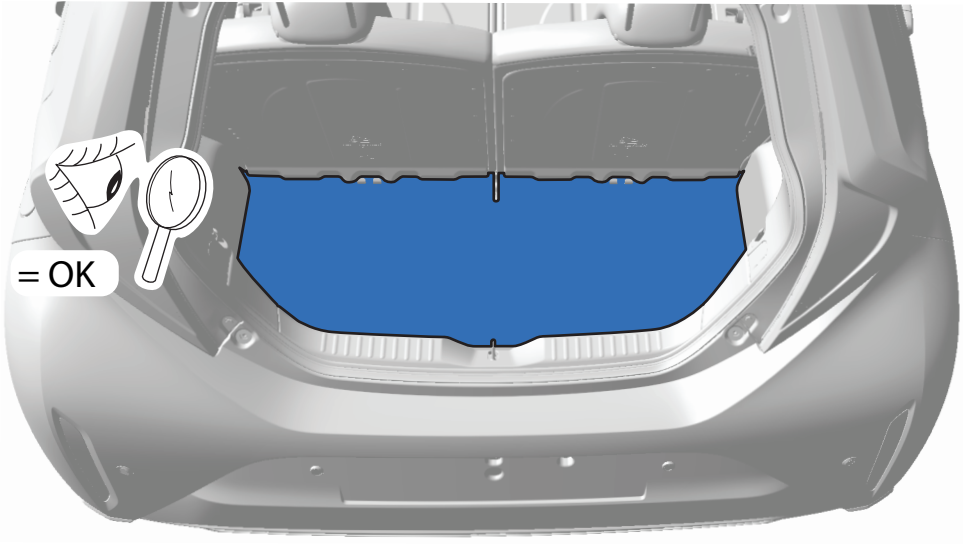

1

Installation Date:

. . / . . / . . . . .

Technician Name & Signature:

Stamp: