

AYGO X

Front Bumper Garnish

Installation Instructions

| | |
|---------------|---|
| Model year: | As from 2022/01 |
| Vehicle code: | KGB70*-AH**KW |
| Part number: | PW401-0H100-01 (Chrome) PW401-0H101-DC (Red) |

Manual reference number: AIM 006 126-2

Latest Version
SCAN HERE



CLICK TO NAVIGATE

REVISION RECORD



Page

3

KIT CONTENT



Page

4

LEGEND



Page

4

GENERAL



Page

4

TOOLS



Page

5

CONSUMABLES



Page

5

PERSONAL PROTECTION EQUIPMENT



Page

5

USEFUL GENERAL MANUALS



Page

6

GENERAL



Page

6

INSTALLATION INSTRUCTIONS



Pages

7 - 21

INFORMATION



Page

22

CHECK SHEET



Pages

23 - 25

THINK BEFORE YOU PRINT



**ONLINE = LATEST VERSION
GO DIGITAL!**

Revision Record

| Rev. No. | Date | Page | Step | Remarks |
|----------|------------|------|------|------------------------------|
| 1 | 24.05.2023 | | | Updated to latest Standards. |
| 2 | 26.10.2023 | | | Updated to latest Standards |
| | | | | |
| | | | | |
| | | | | |
| | | | | |
| | | | | |

KIT CONTENT

PW401-0H100-01 (Chrome)
PW401-0H101-DC (Red)

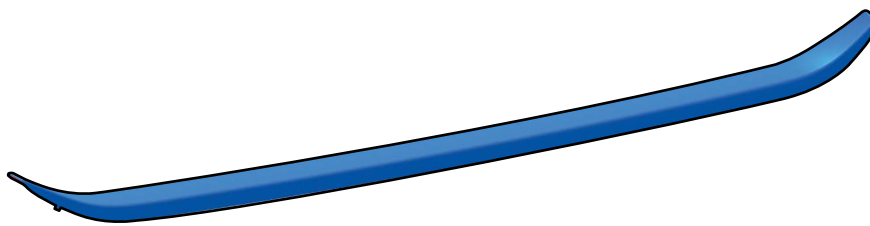

A

x1

B



x3

C

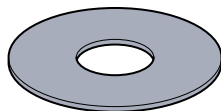

x2

D



x1

Template



x1





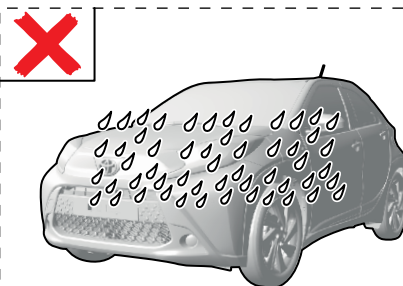
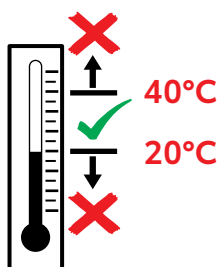
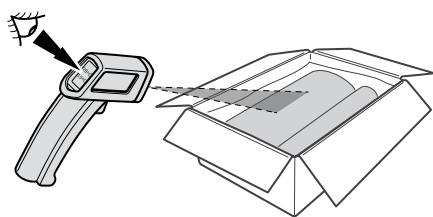
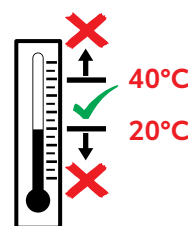
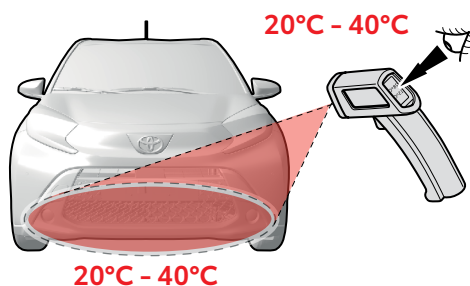

LEGEND

| | | |
|----------|-------|---------|
| = XX mm | = or | = |
| = XX mm | = | = |
| = | = | = |
| = TXX | = | = START |

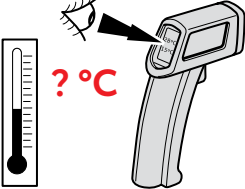
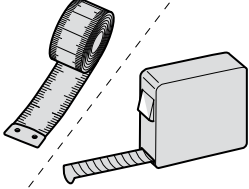
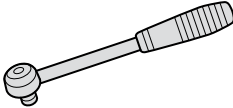
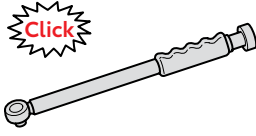
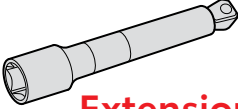
GENERAL

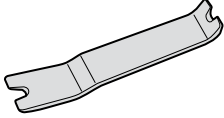
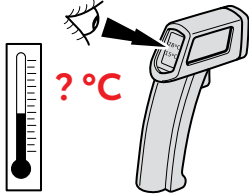
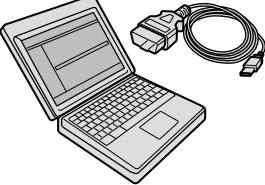
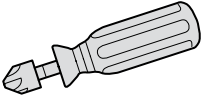
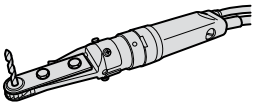

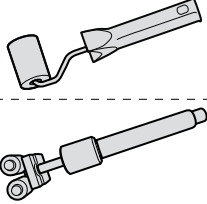
TOOLS

| TEMPERATURE SENSOR | TAPE MEASURE | RATCHET | TORQUE WRENCH | EXTENSION BAR |
|--|--|--|---|---|
|  |  |  |  |  Extension 250mm |
| HEXAGONAL SOCKET | PLASTIC TRIM REMOVAL TOOL | TEMPERATURE SENSOR | TOYOTA GTS DIAGNOSTIC TOOL | DE-BURRING TOOL |
|  10mm |  |  |  |  |
| 90° DRILL | COBALT DRILL BIT | PRESSURE ROLLER | STOP WATCH | |
|  |  Ø 3,5 mm Ø 9 mm Ø 11 mm |  |  | |

CONSUMABLES

| CLEANER / DEGREASER SPRAY | MASKING TAPE | NON PERMANENT MARKER | | |
|---|---|---|--|--|
|  |  |  | | |

PERSONAL PROTECTION EQUIPMENT

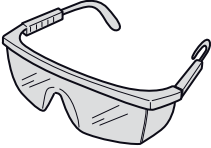
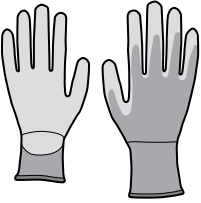
| SAFETY GLASSES | PROTECTIVE GLOVES | | | |
|--|---|--|--|--|
|  |  | | | |

USEFUL GENERAL MANUALS

CLEANER / DEGREASER



Latest Version
SCAN HERE

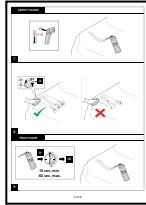

SYMBOLS



Latest Version
SCAN HERE



INSTALLATION CONDITIONS



Latest Version
SCAN HERE

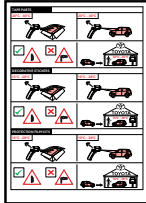

DISCLAIMER



Latest Version
SCAN HERE



GENERAL



Info



Material Safety Data Sheet



Technical Data Sheet

GENERAL



Info

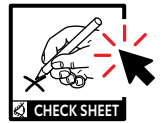
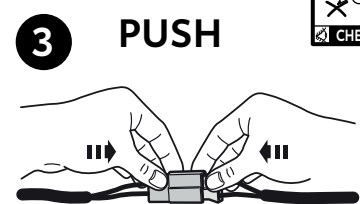
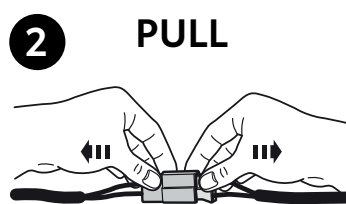
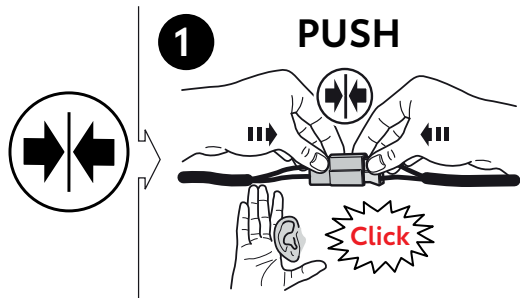

INSTALLATION INSTRUCTIONS

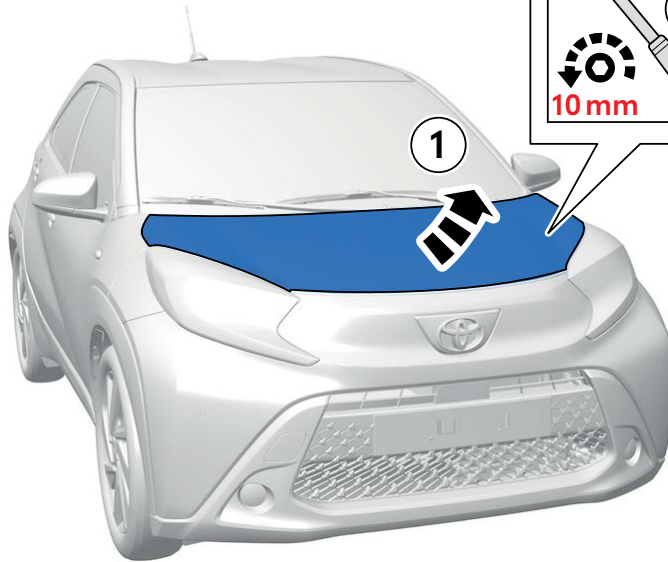
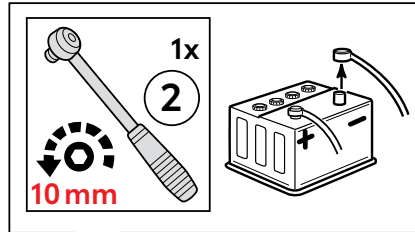



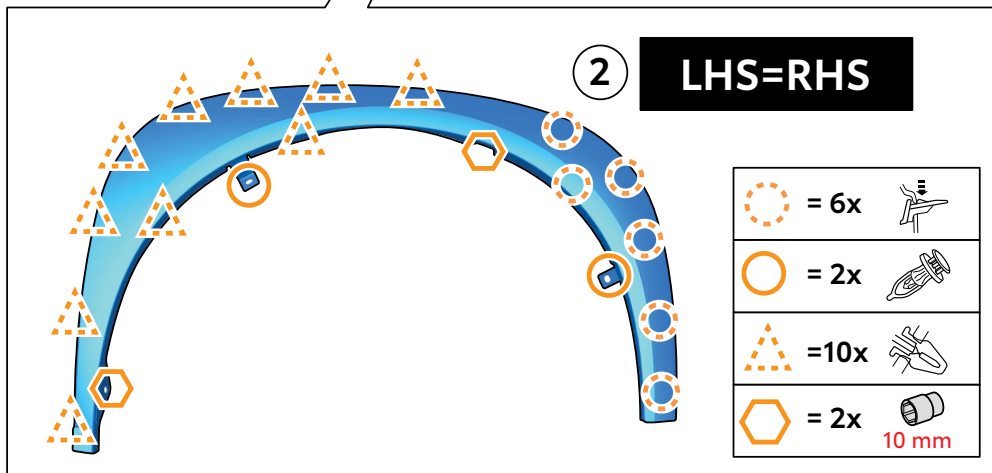
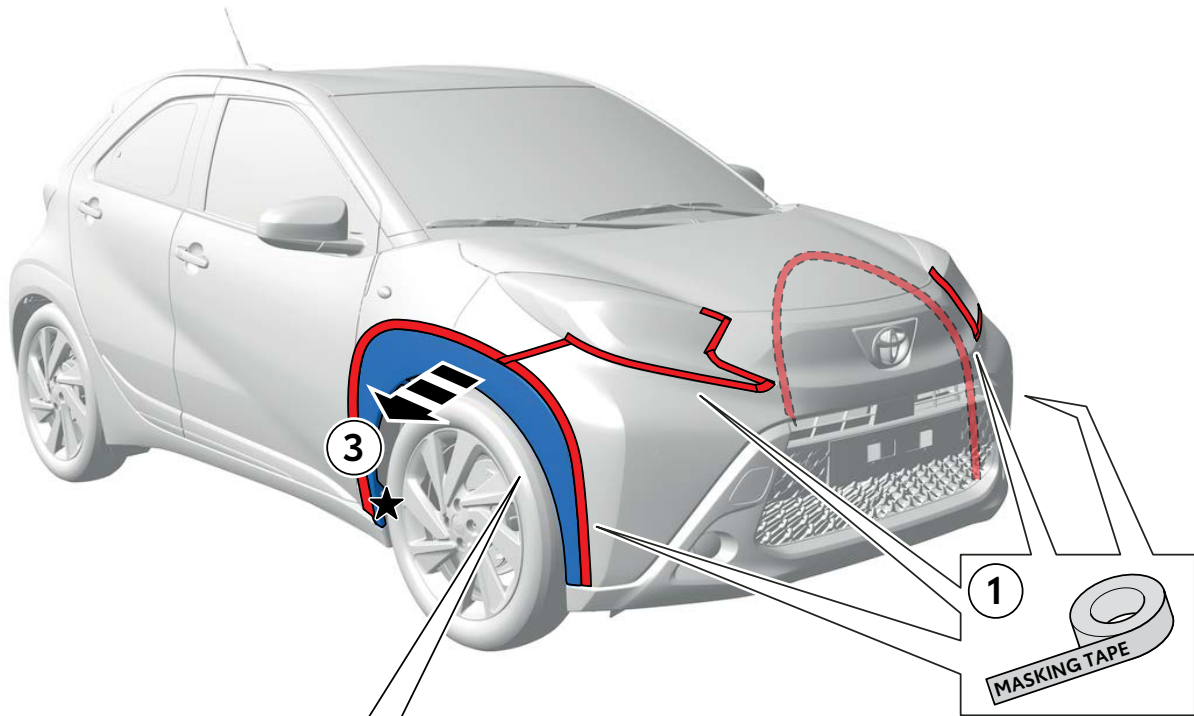

1

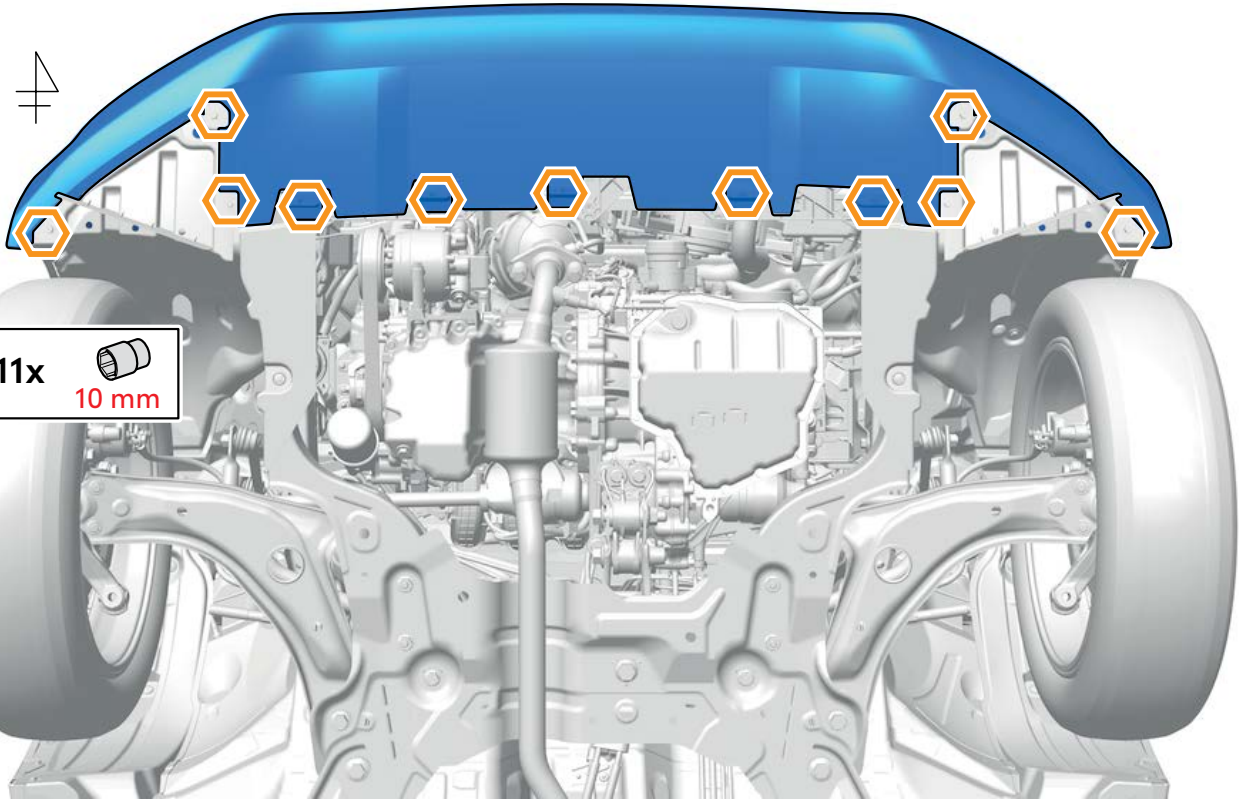



2



 = 11x  10 mm

 = 2x 

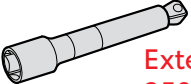
 = 2x  10 mm
 Extension 250mm

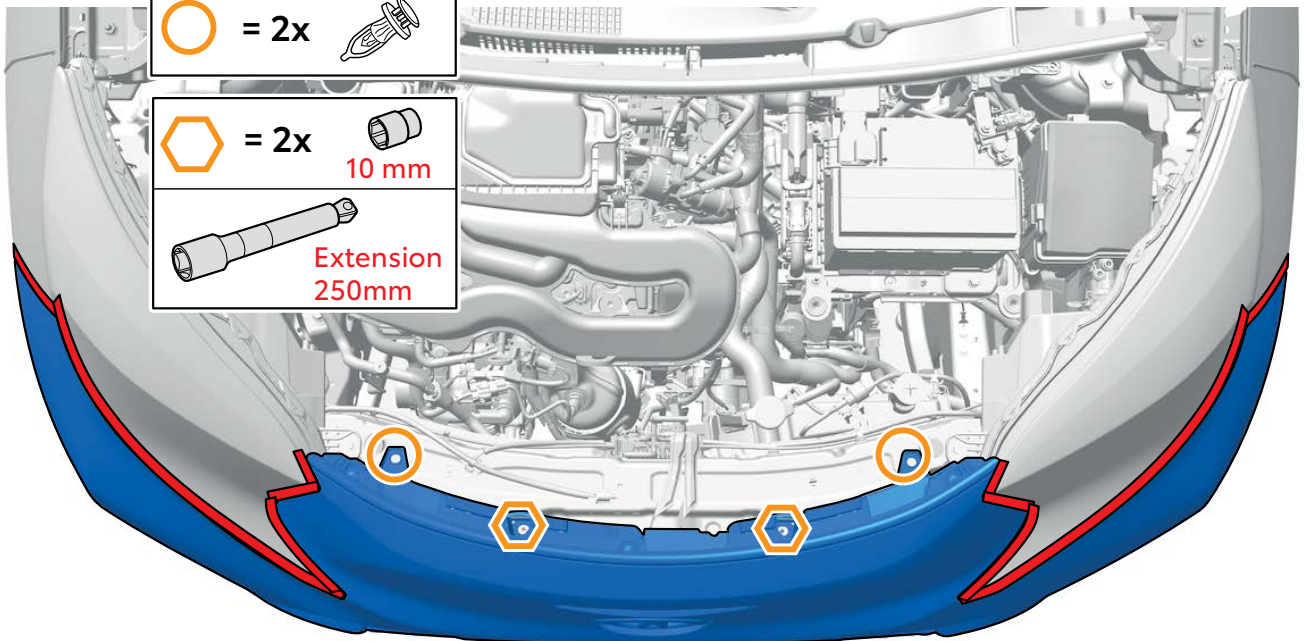

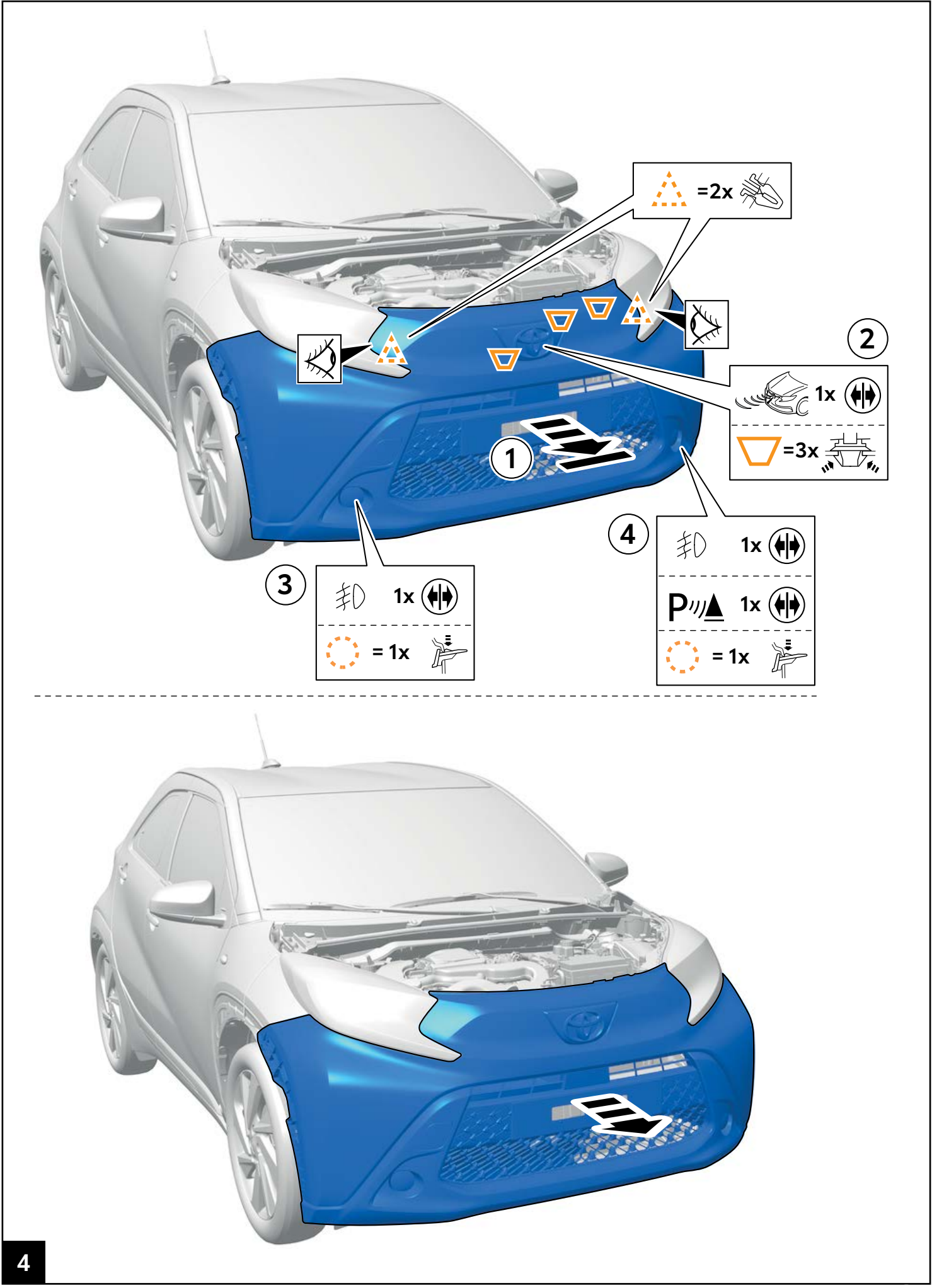

4

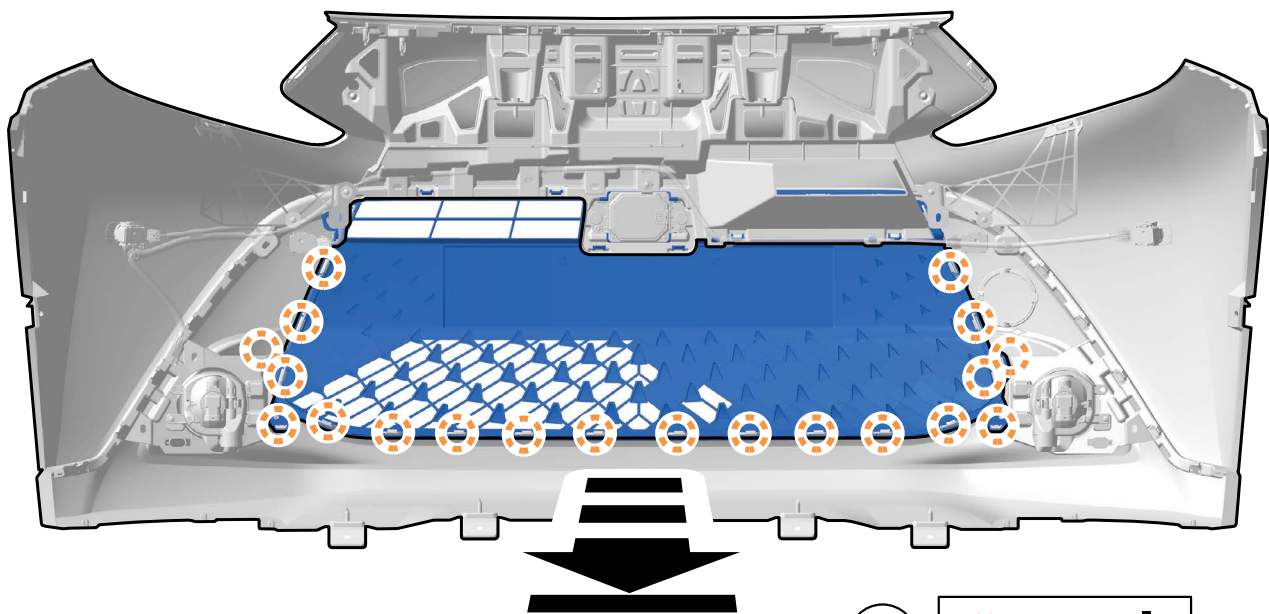
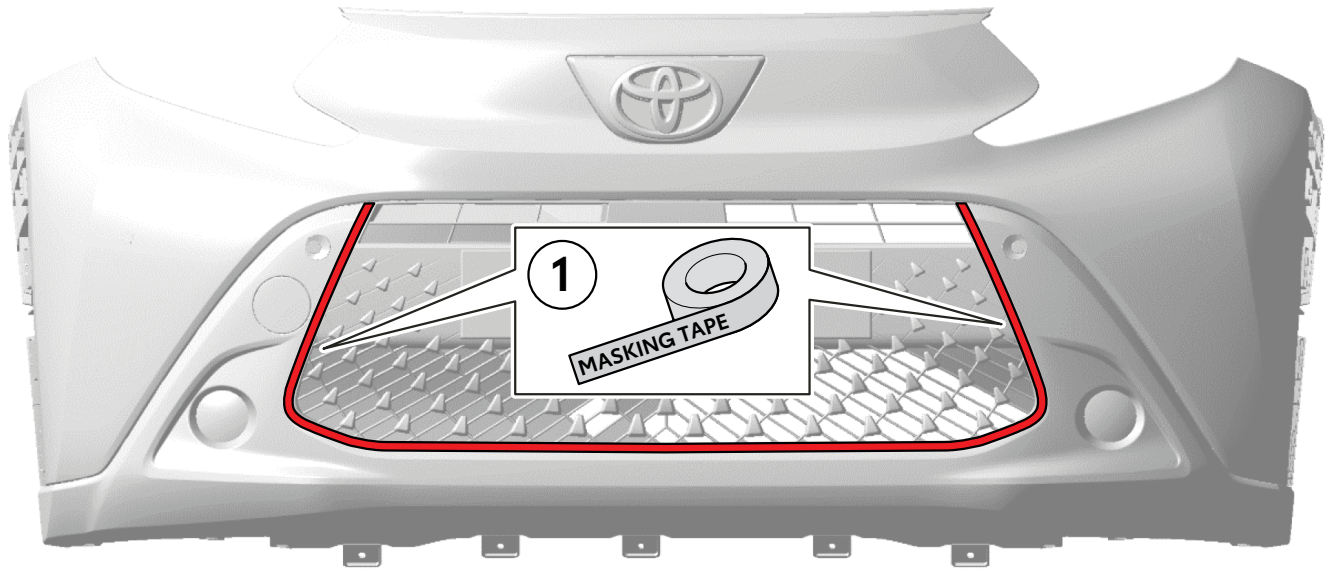

2 =20x 

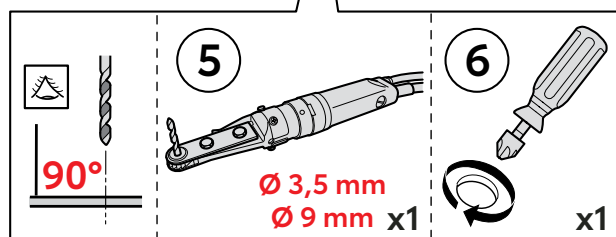
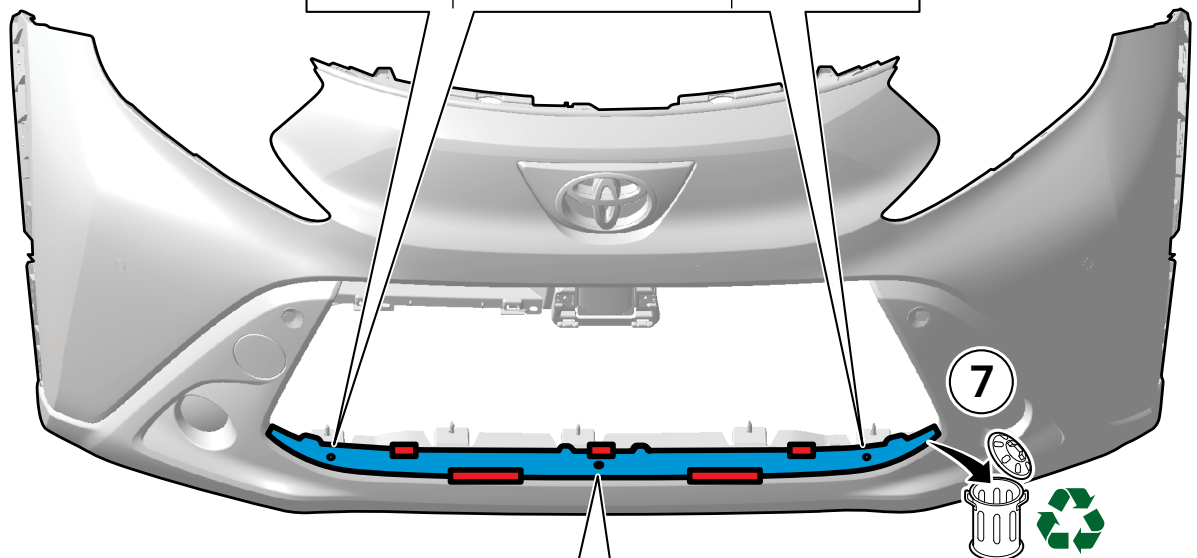
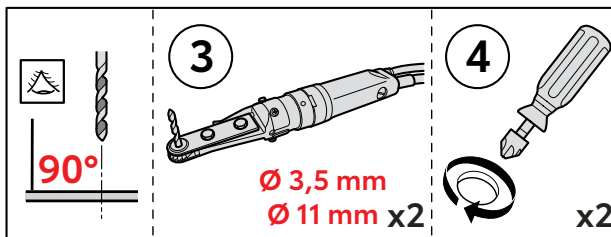
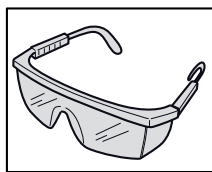
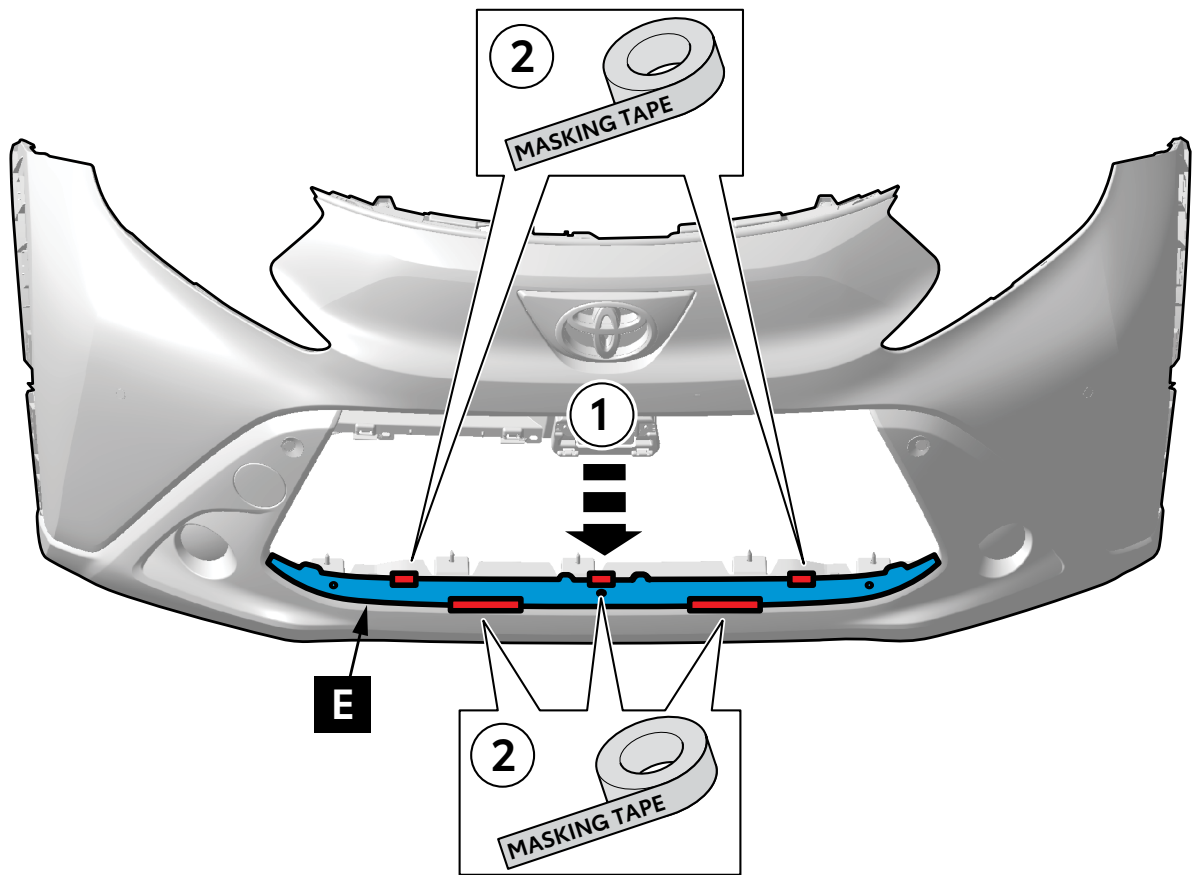

6

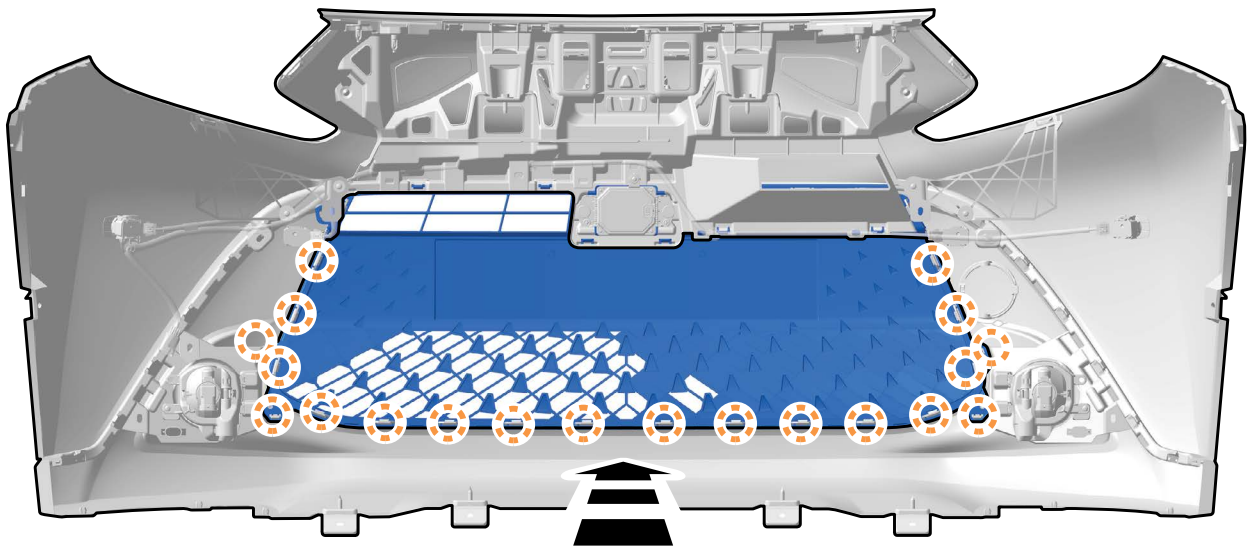

1  =20x 

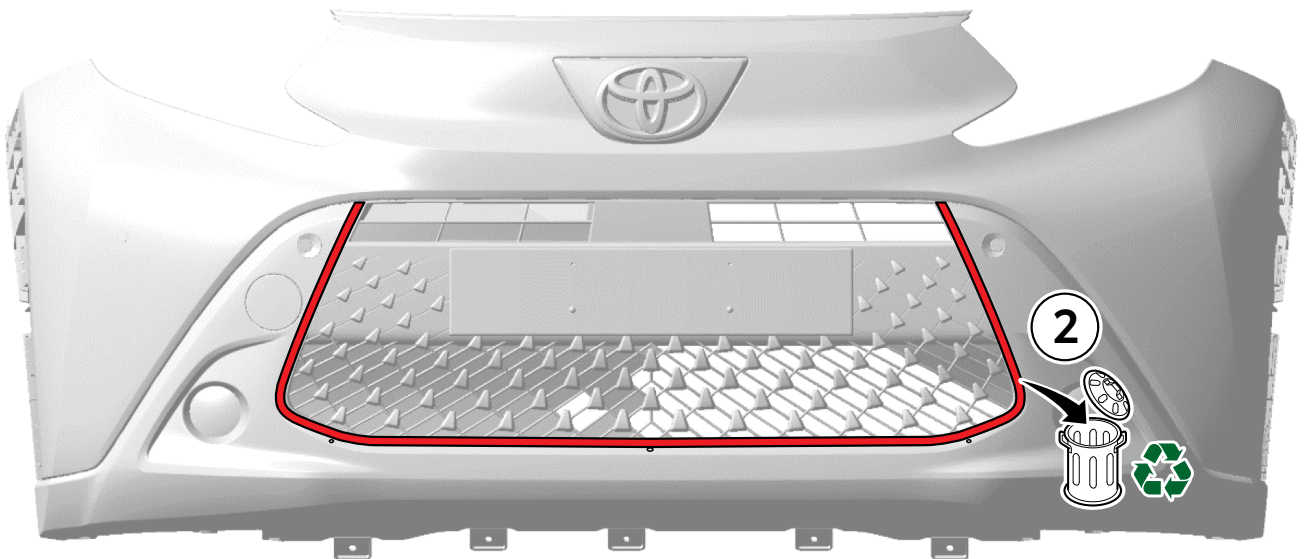

2



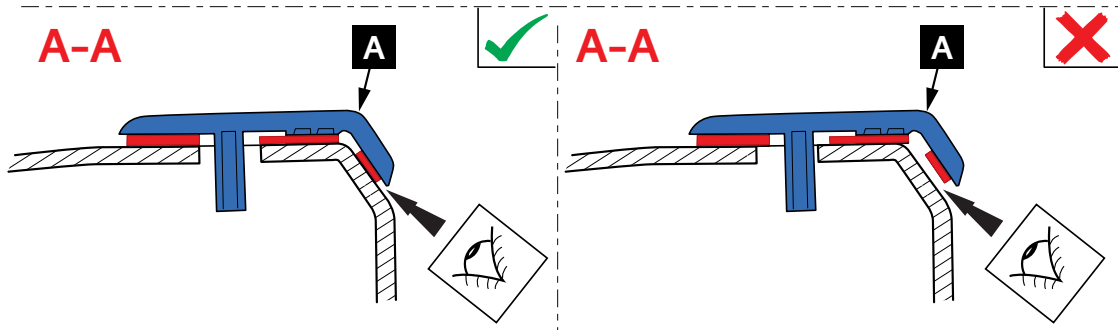
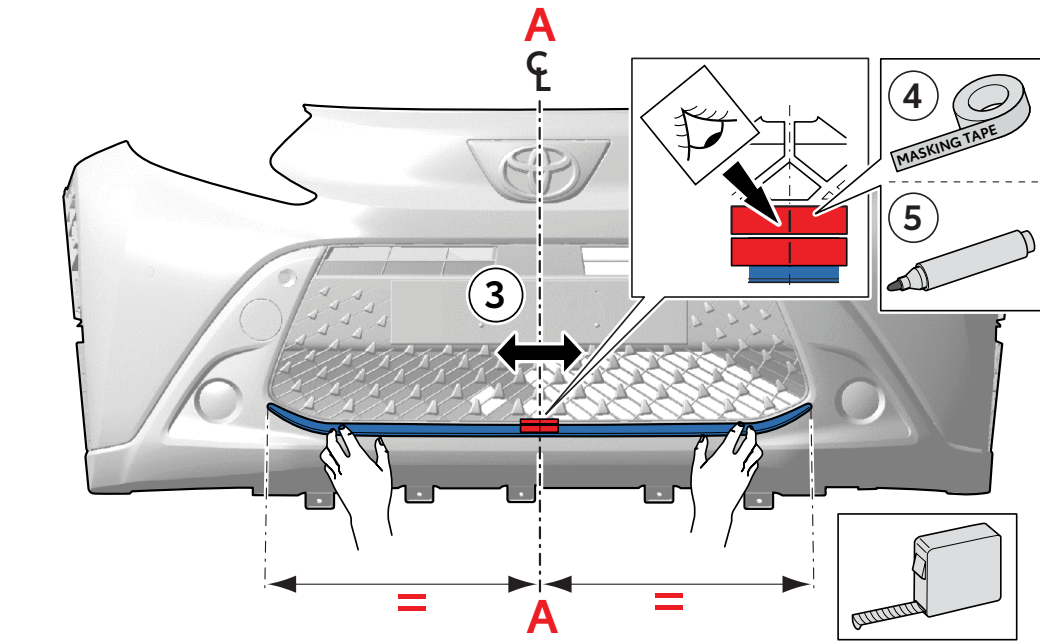
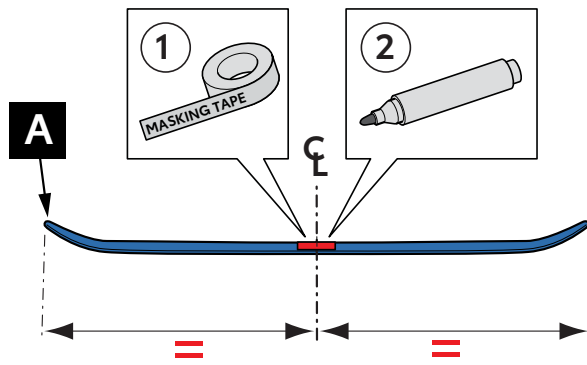

8

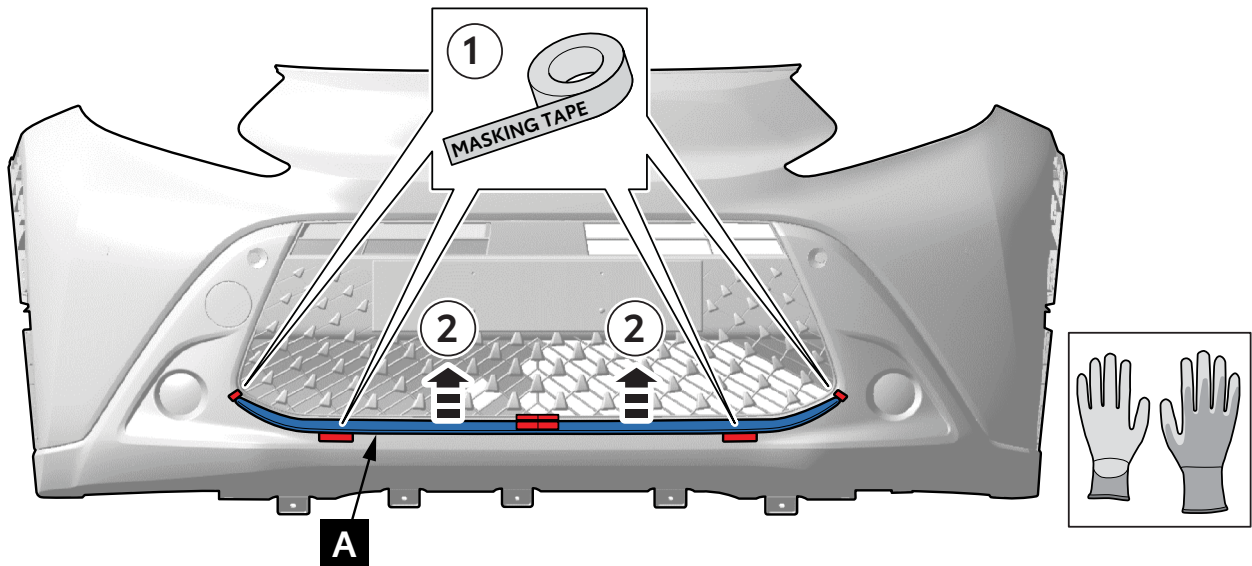

9

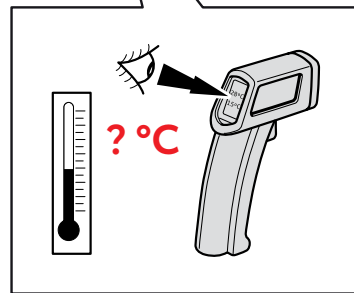
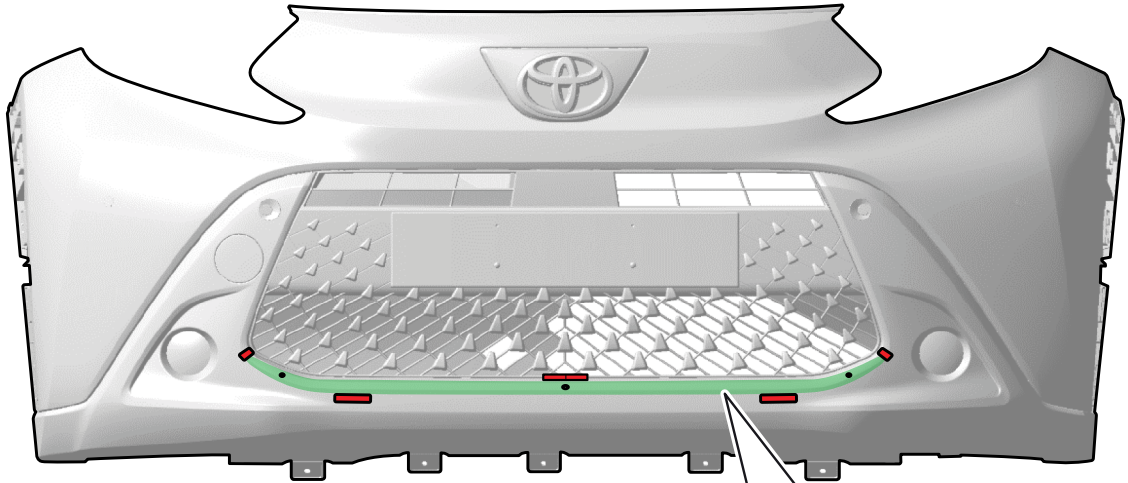

10

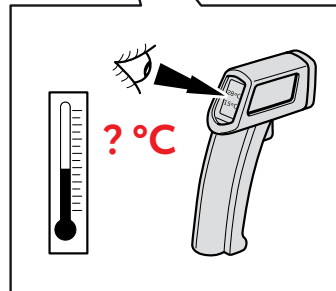
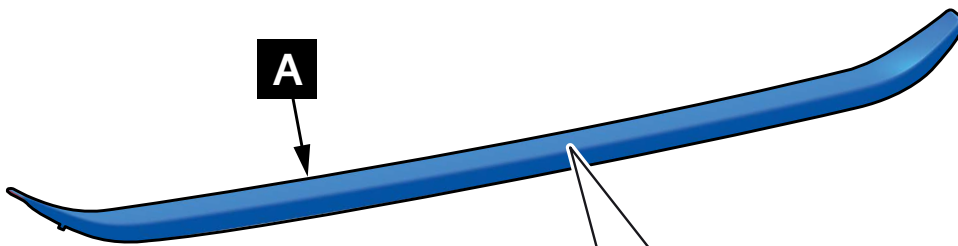

11

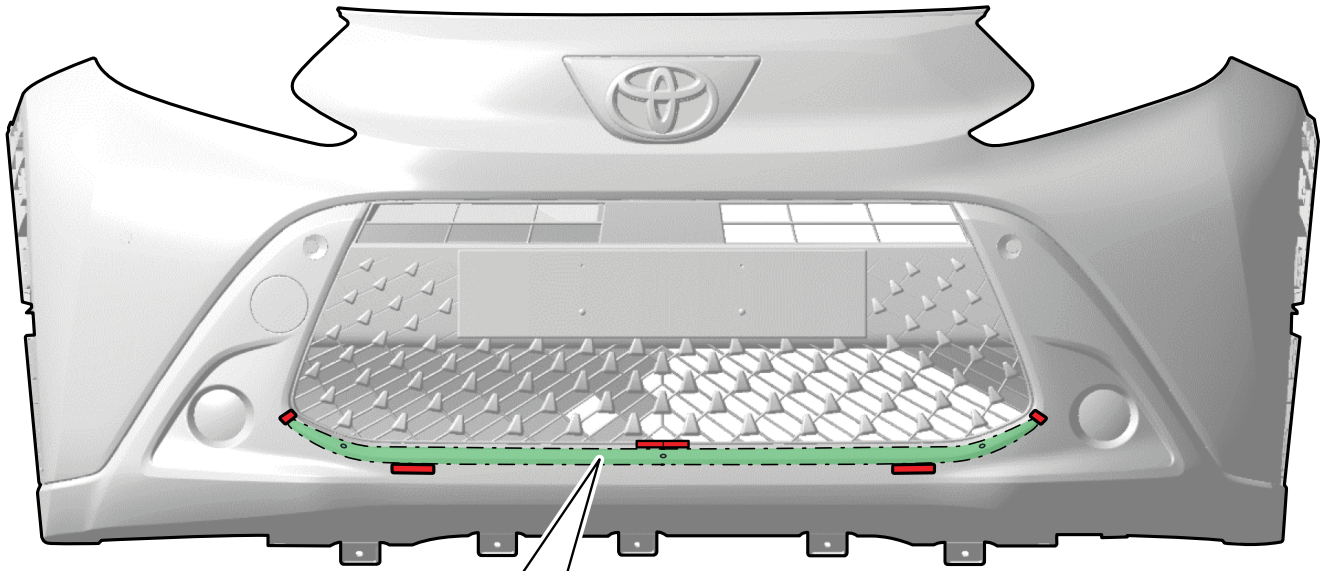

| | | | |
|----------|-----------------|-------------------|--|
| <p>1</p> | <p>X</p> | <p>2</p> <p>3</p> | <p>4</p> <p>→ 14</p> <p>≥ 45 sec. < 1 hour</p> |
|----------|-----------------|-------------------|--|

12

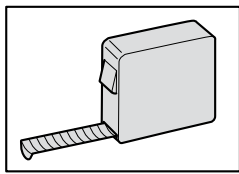

50mm 50mm

50mm

A

X

13

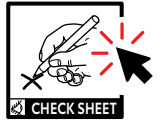

2

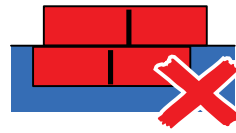
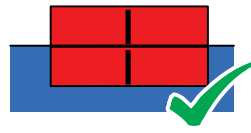

3

A

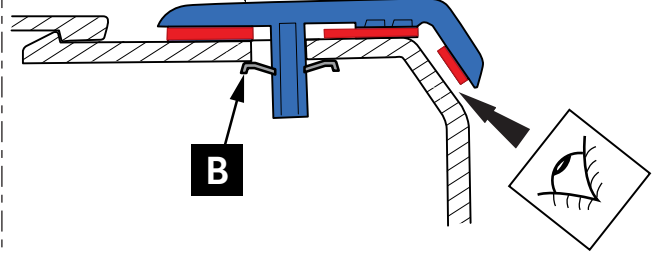
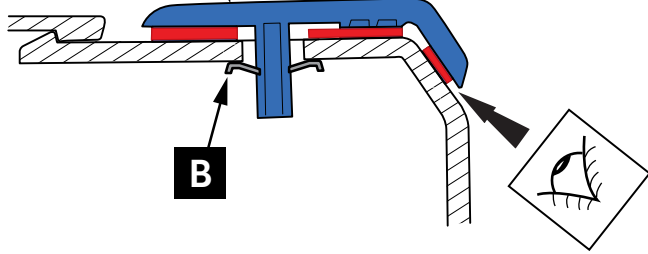

2

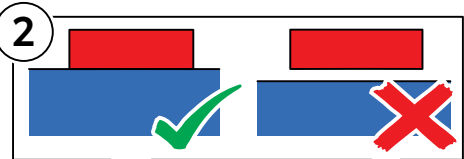

2

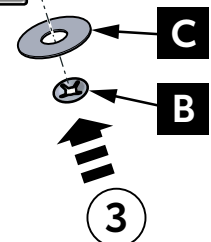
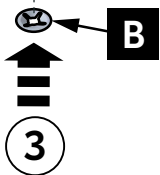
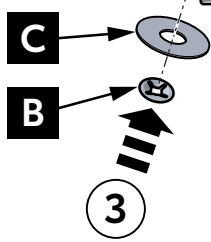
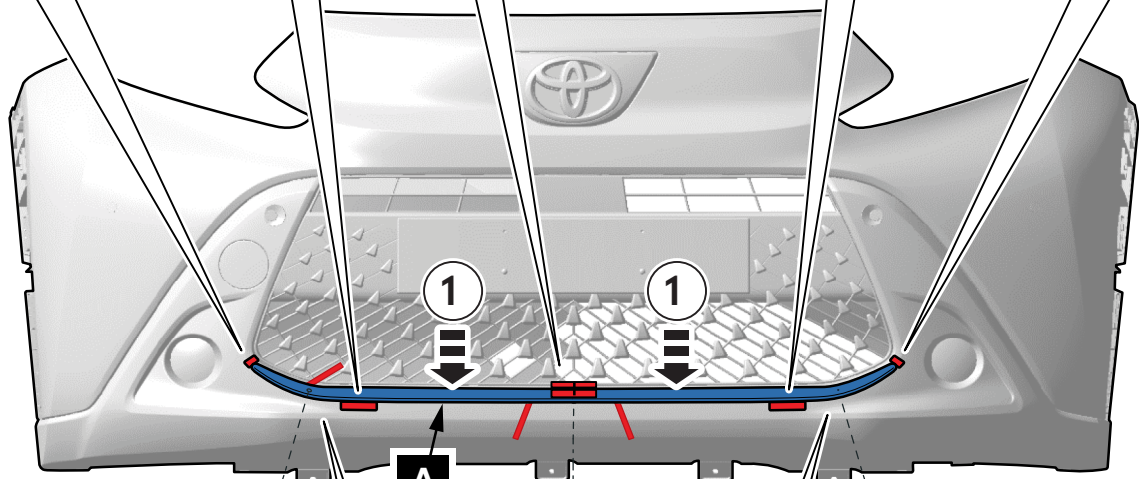
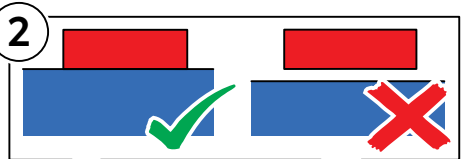

3

A

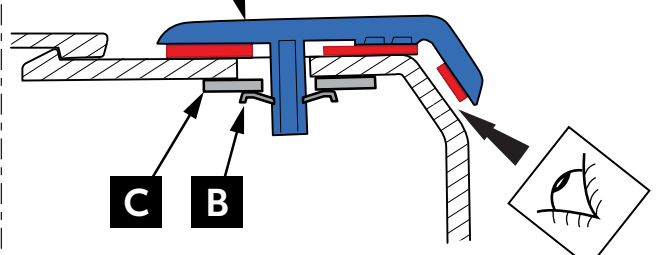
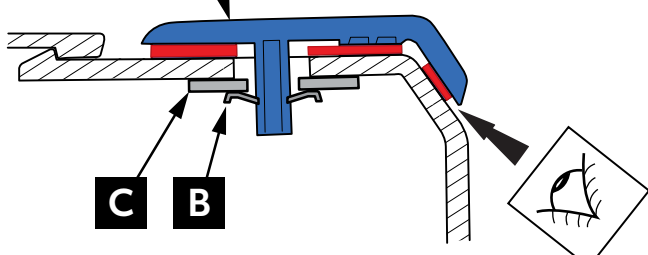

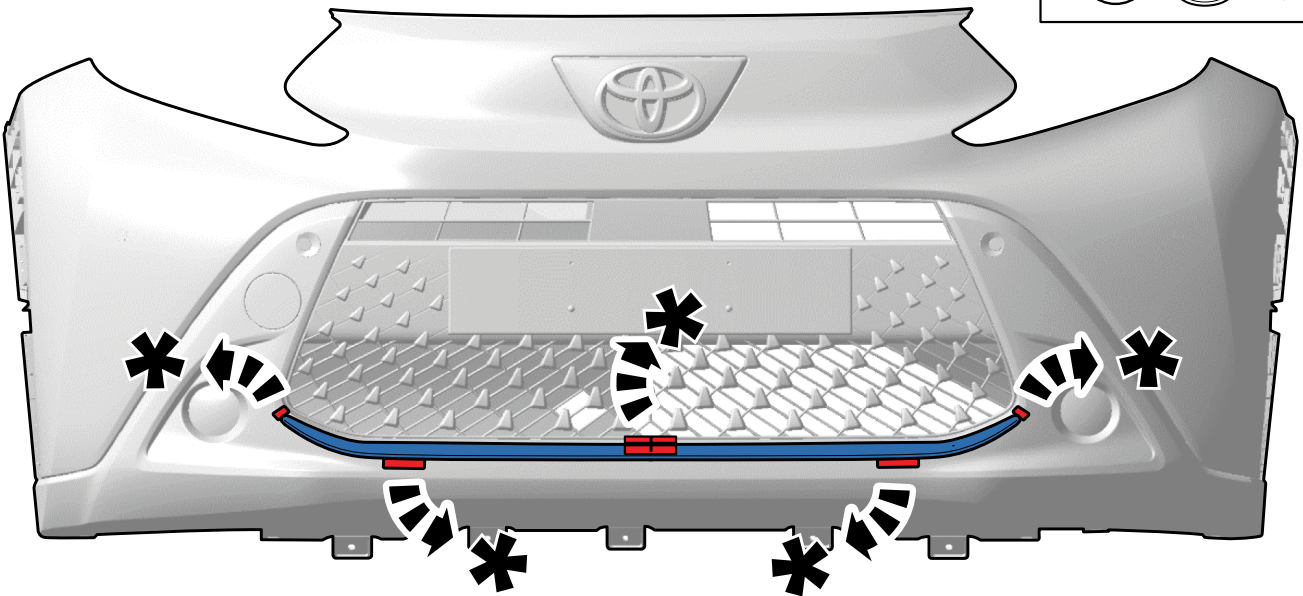
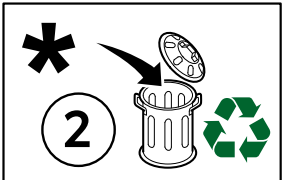
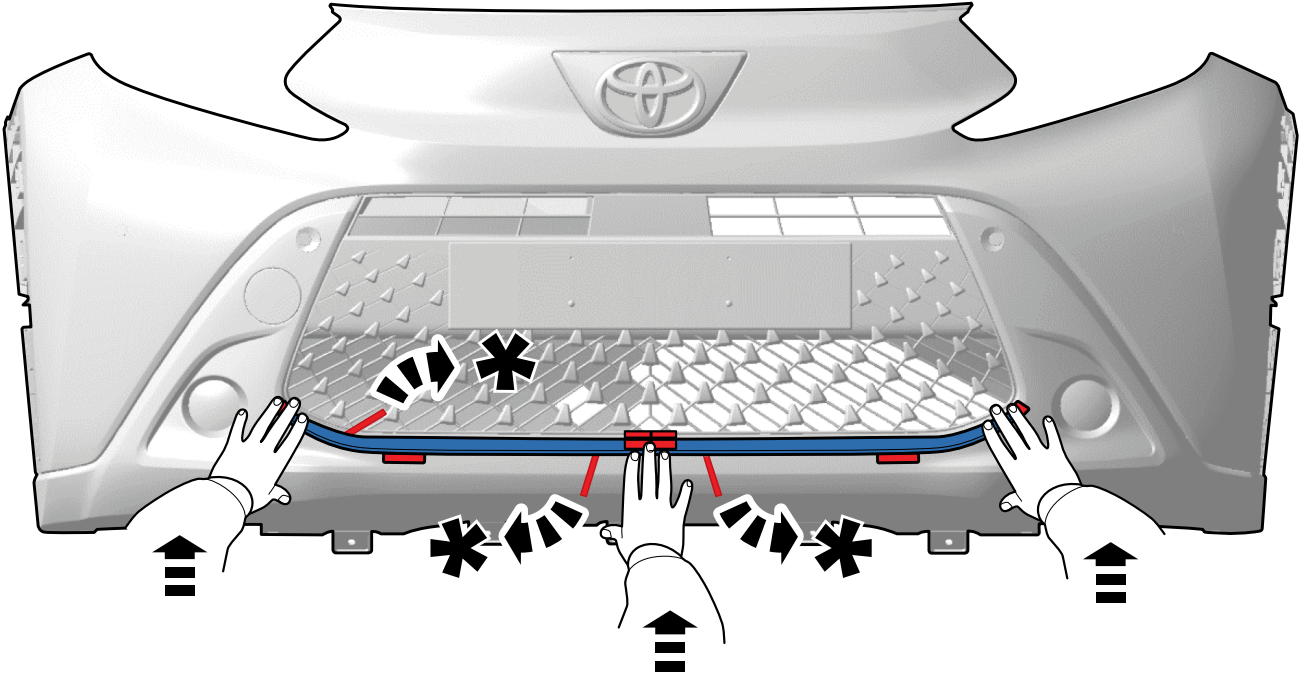
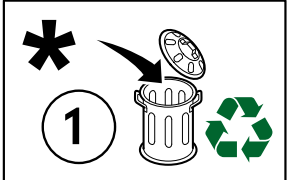

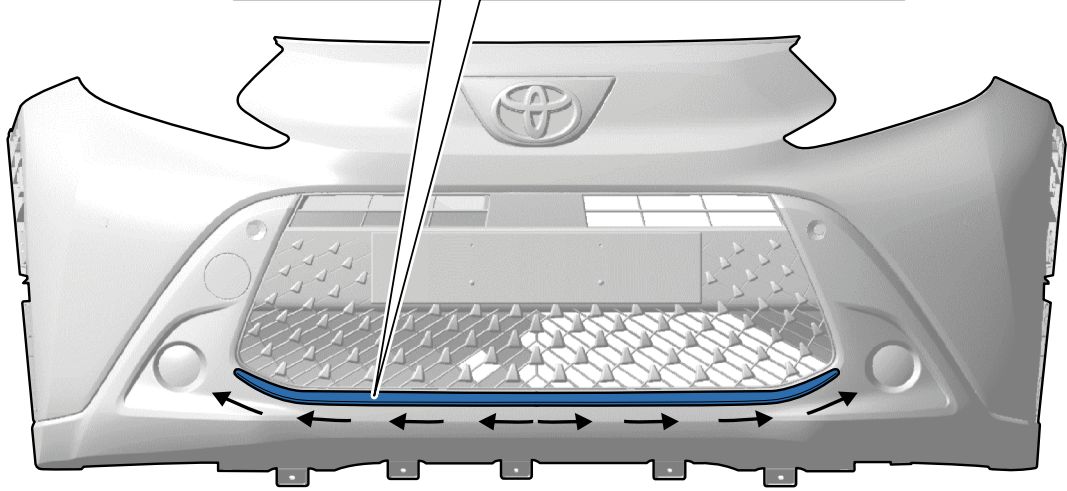
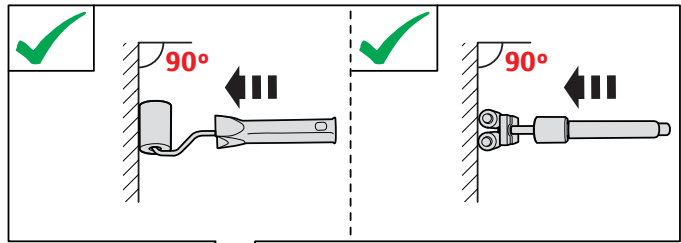

16

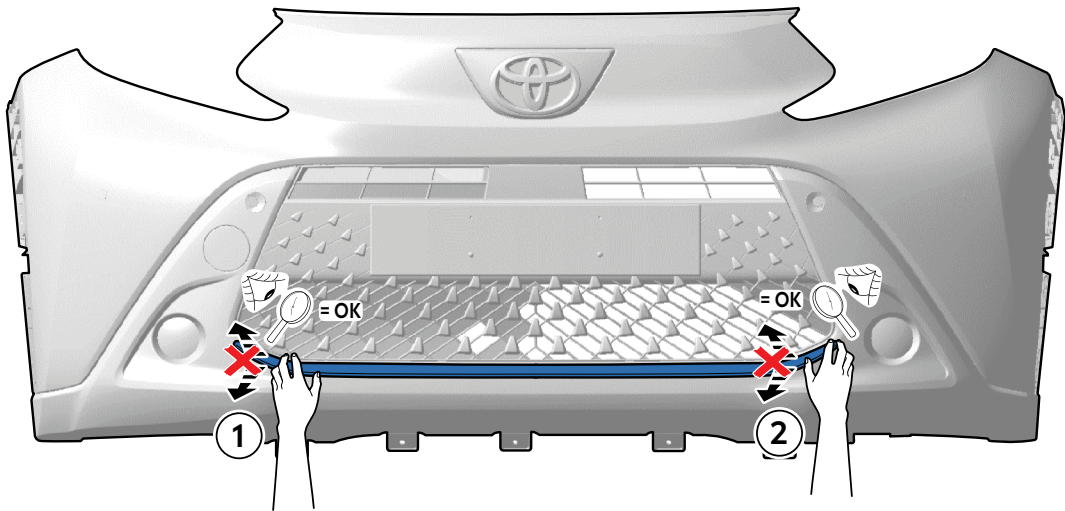

17

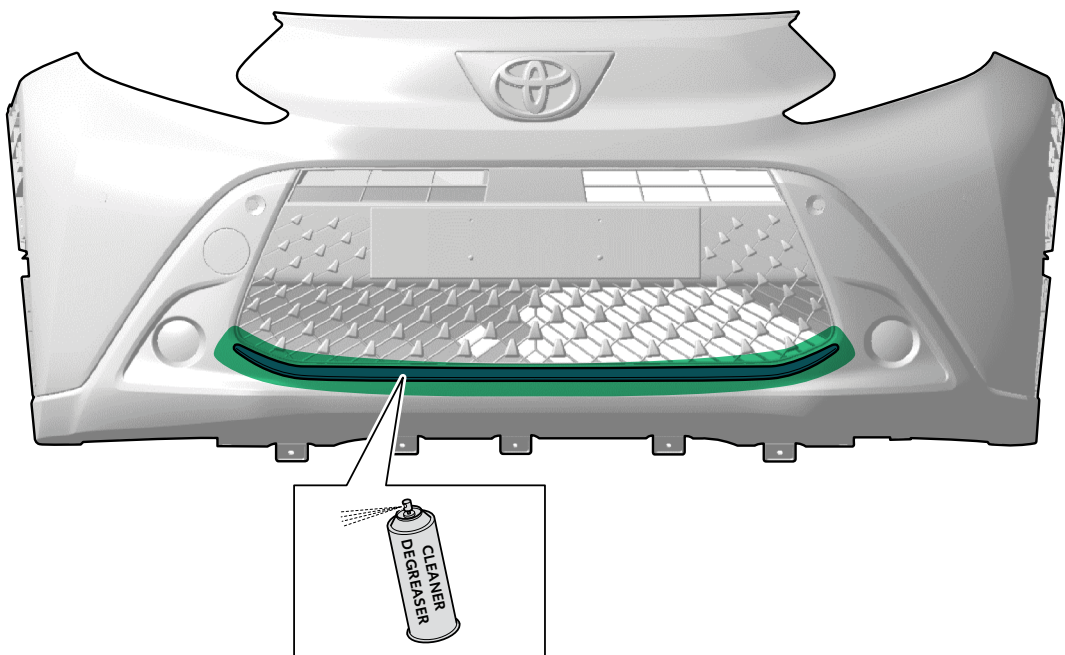

18

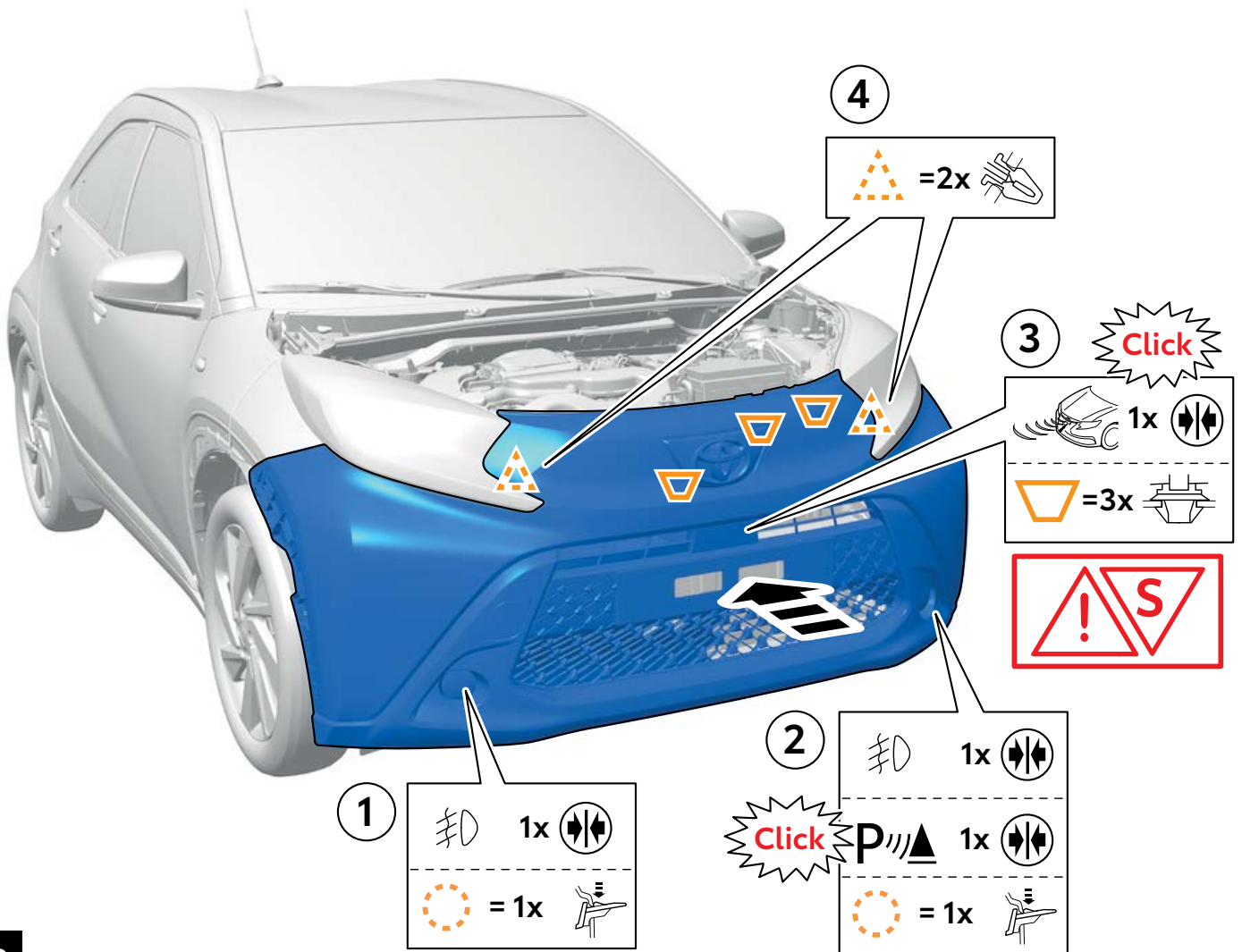

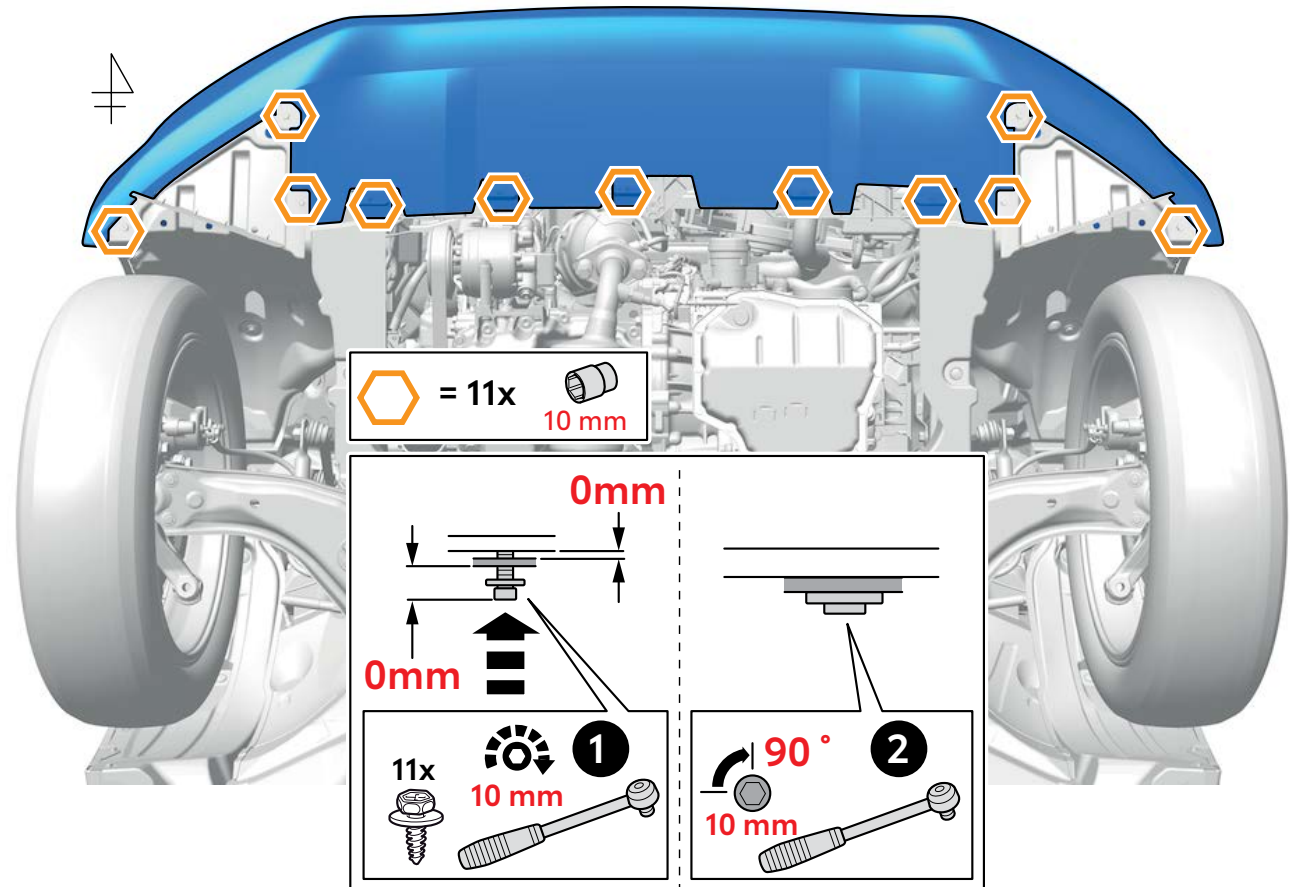
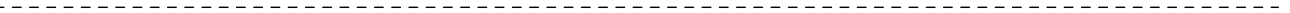
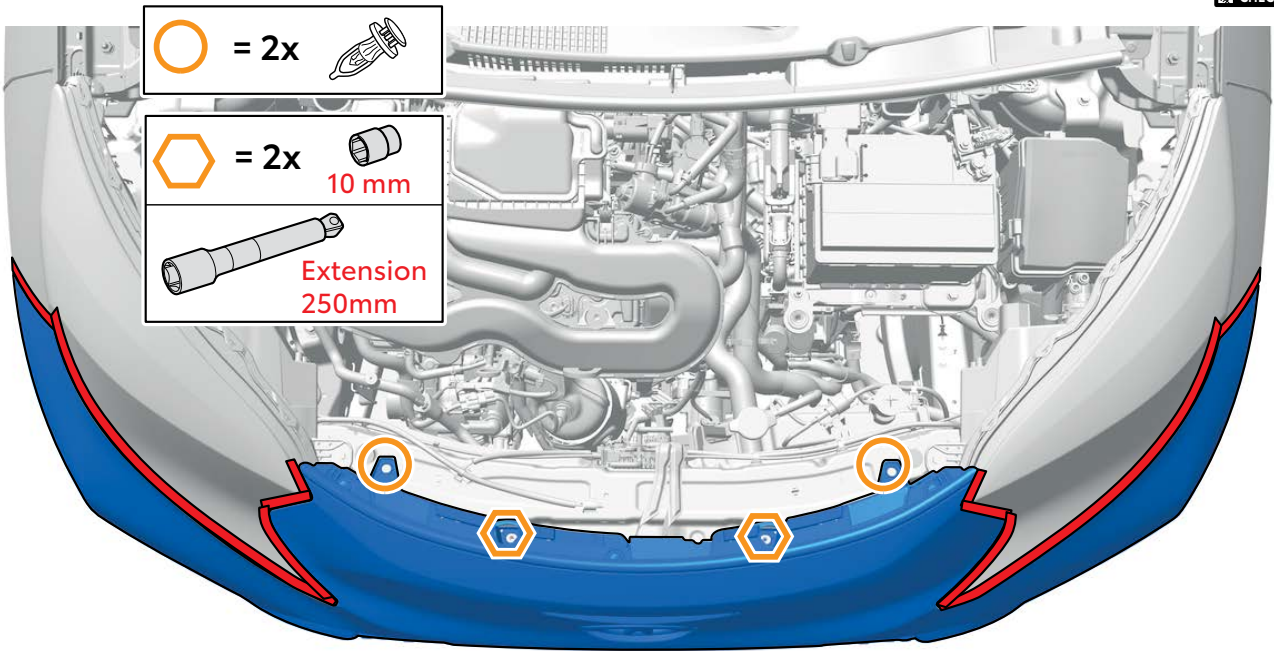

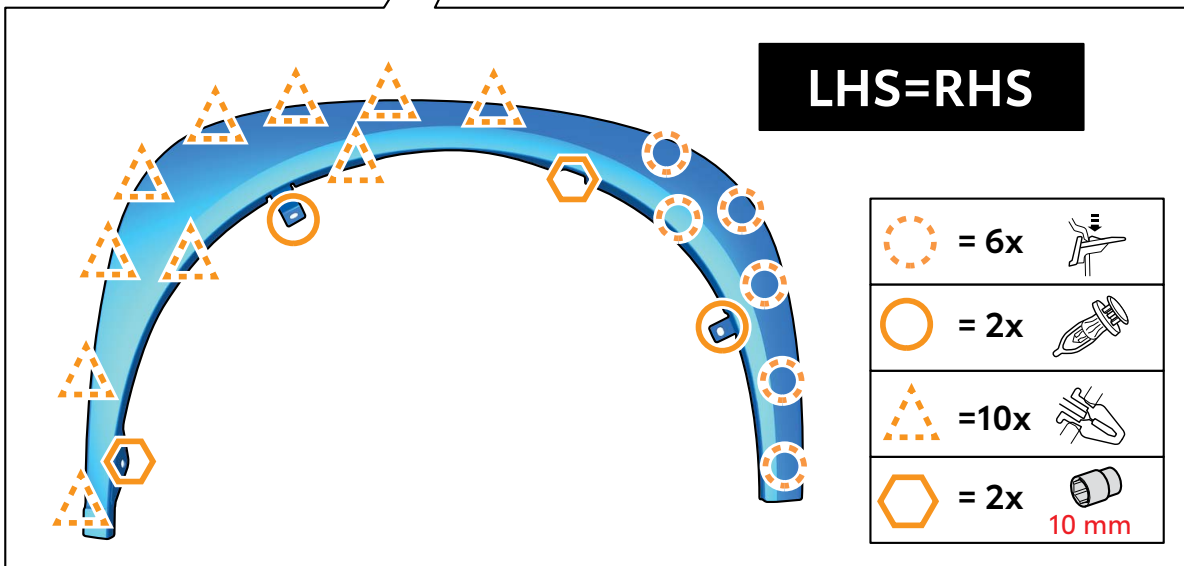
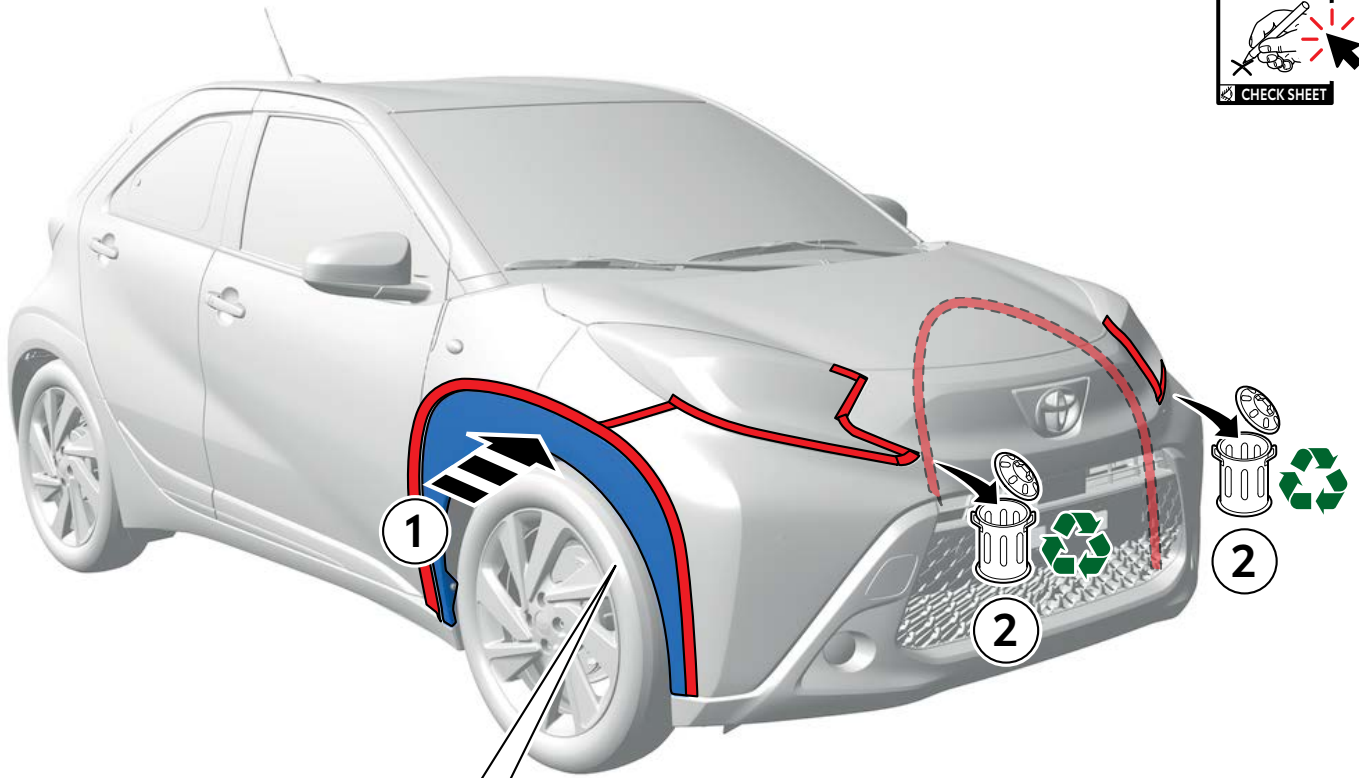
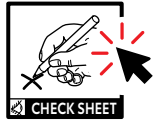

21

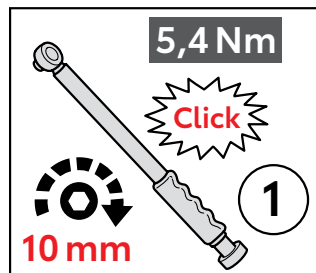
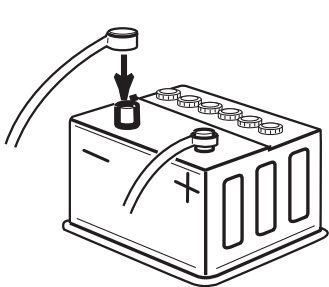

22

INFORMATION

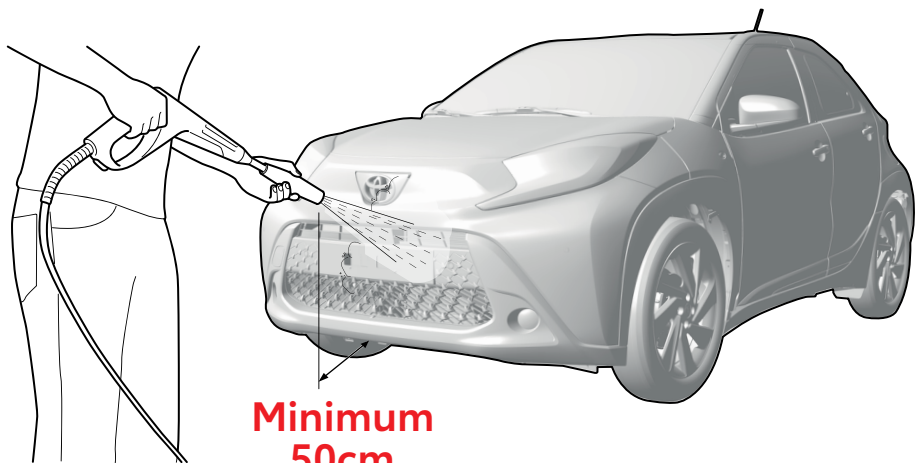
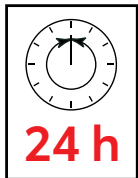
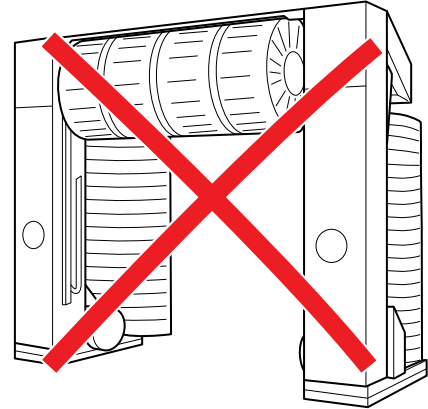
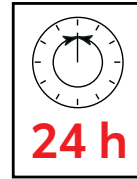
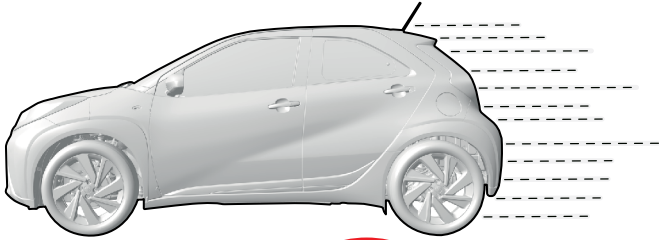
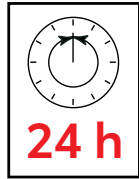

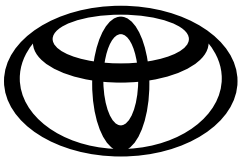

CHECK SHEET

Page 1 of 3

Model/Year **AYGO X**
As from 2022/01

Front Bumper Garnish

VINn°

DURING INSTALLATION

1

= OK
↑
P/N = OK

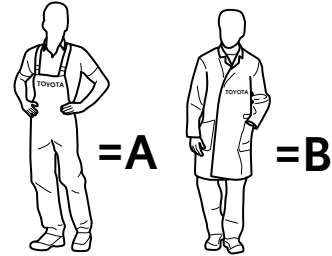

2

PUSH PULL PUSH
Click
↑

3

A B
A B
A B
A B
A
C B
C B
↑

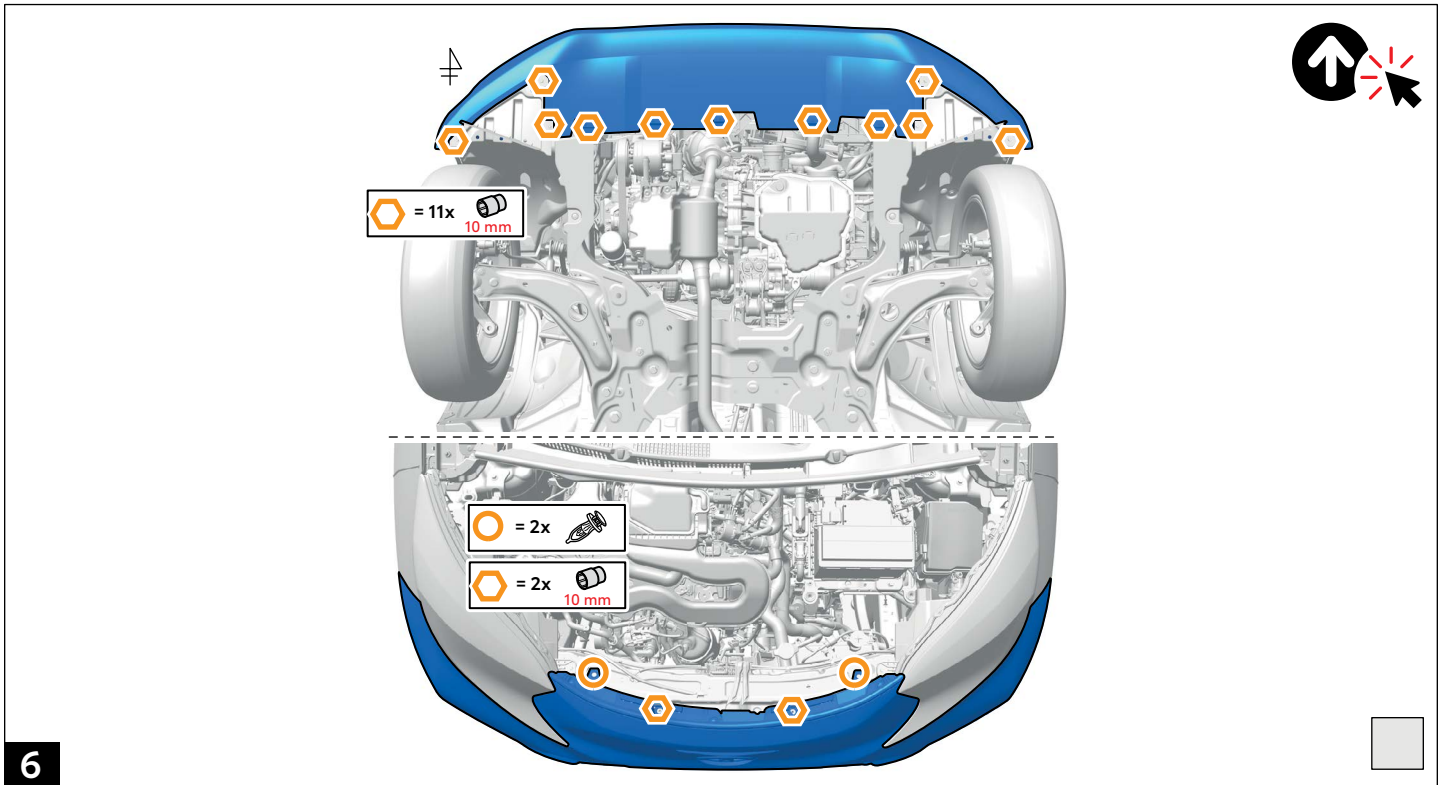
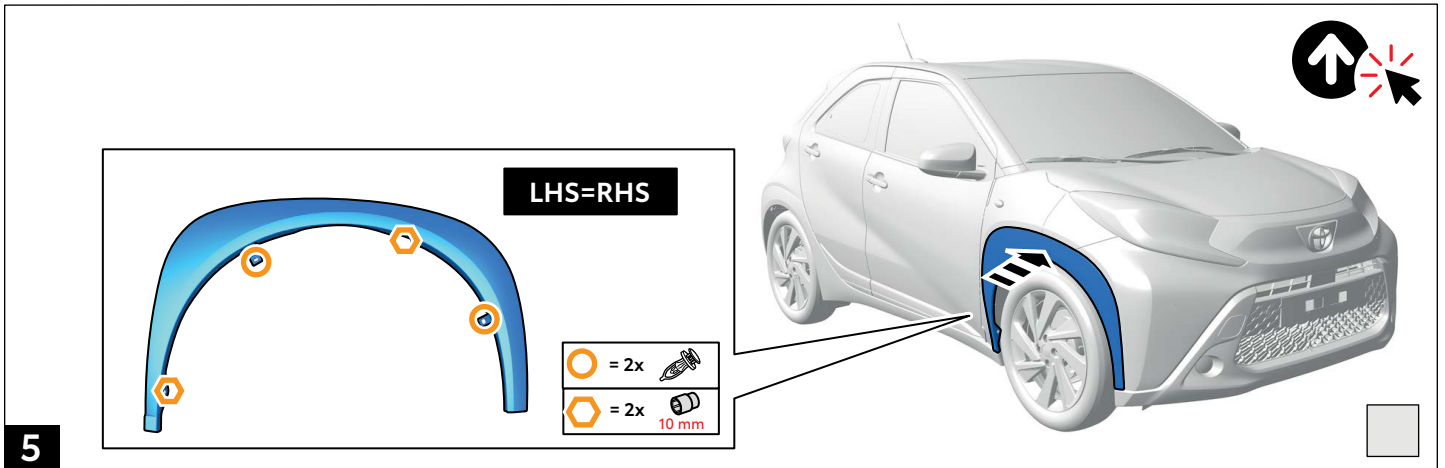
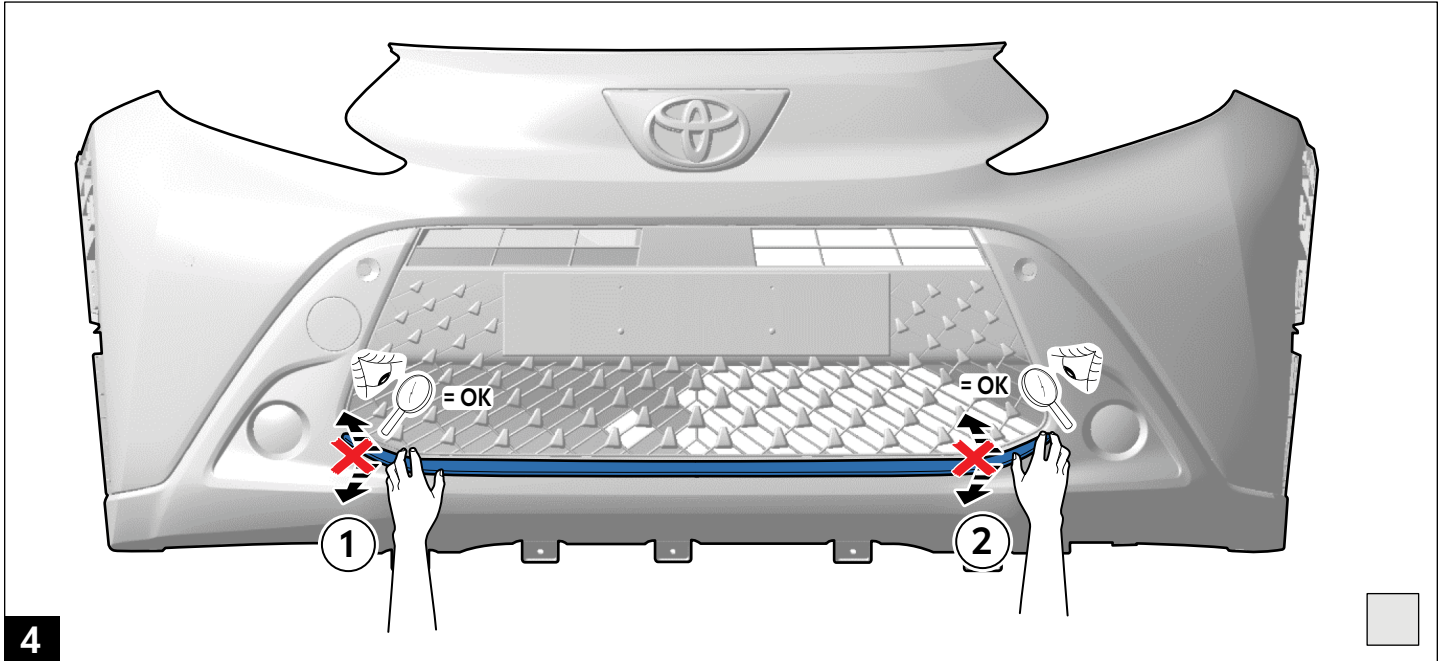

1



5,4 Nm

Serial Number

Click



2



! S

Click

A B

= OK

P



3

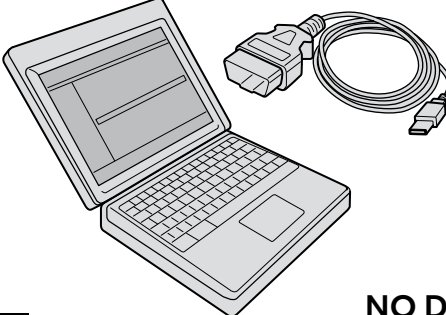

DIAGNOSTIC TOOL

NO DTC=OK

4

= OK

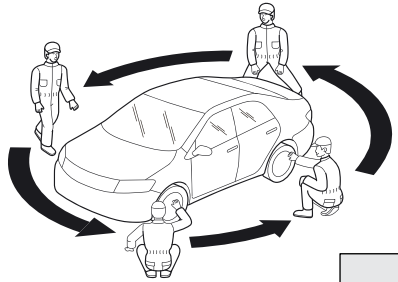

Installation Date:
.. / .. / ..

Technician Name & Signature:

Stamp: