

# AYGO X

## Side Sills

### Installation Instructions

Model year: As from 2021/09

Vehicle code: KGB70\*-AH\*\*KW

Part number: PW156-0H010-01 (Chrome)  
PW156-0H101-DC (Red)

Manual reference number: AIM 006 121-3

**Latest Version  
SCAN HERE**



## CLICK TO NAVIGATE

**REVISION RECORD**



Page

3

**KIT CONTENT**



Page

4

**TOOLS**



Page

4

**CONSUMABLES**



Page

4

**PERSONAL PROTECTION EQUIPMENT**



Page

4

**GENERAL**



Page

5

**USEFUL GENERAL MANUALS**



Page

5

**INSTALLATION INSTRUCTIONS**



Pages

6 - 10

**INFORMATION**



Page

10

**CHECK SHEET**



Pages

11 - 13

**THINK BEFORE YOU PRINT**



**ONLINE = LATEST VERSION  
GO DIGITAL!**

## Revision Record

Rev. No.	Date	Page	Step	Remarks
3	26.10.2023			Updated to latest Standards

# KIT CONTENT

PW156-0H010-01 (Chrome)  
PW156-0H101-DC (Red)



**LHS** PW156-0H011-01 (Chrome)  
PW156-0H111-DC (Red)

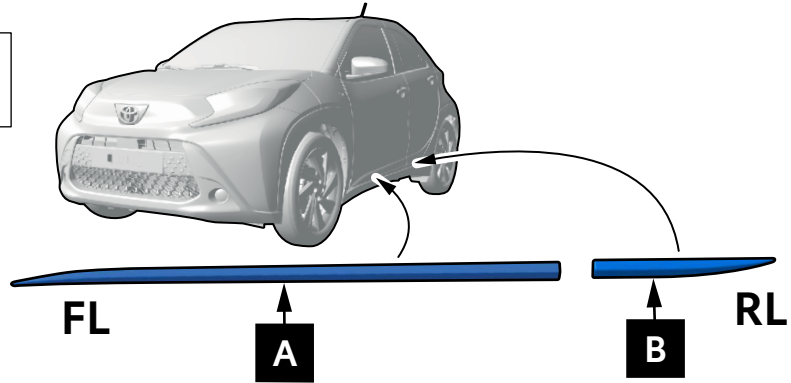

**RHS** PW156-0H012-01 (Chrome)  
PW156-0H121-DC (Red)

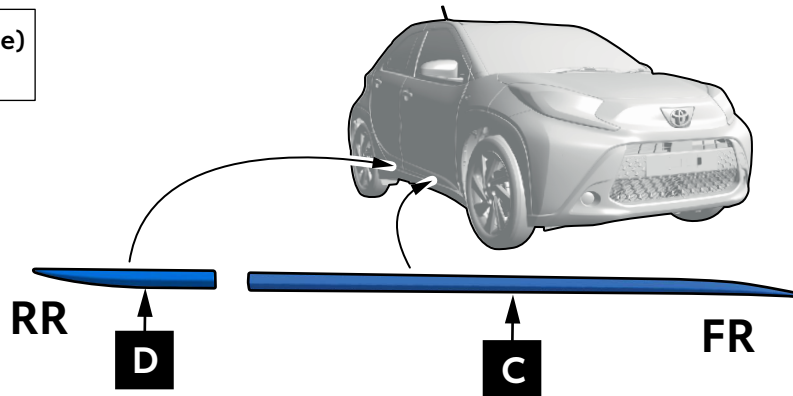

## TOOLS

PRESSURE ROLLER	TAPE MEASURE	TEMPERATURE SENSOR	RULER

## CONSUMABLES

CLEANER / DEGREASER SPRAY				

## PERSONAL PROTECTION EQUIPMENT

PROTECTIVE GLOVES				

# GENERAL

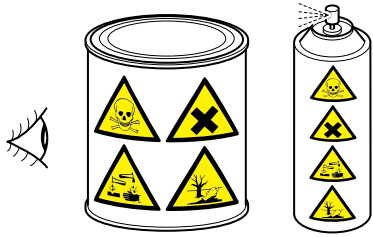

Material Safety Data Sheet



Technical Data Sheet

# GENERAL



LHS=RHS

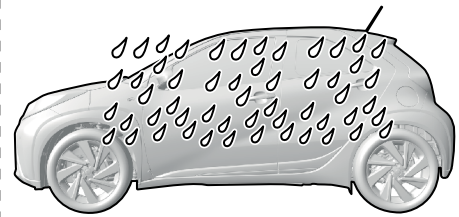
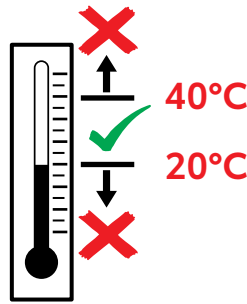
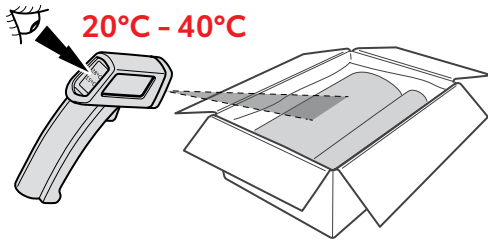
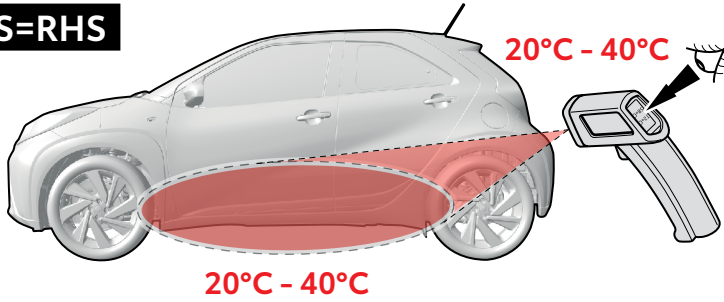

# USEFUL GENERAL MANUALS

## CLEANER / DEGREASER



Latest Version  
SCAN HERE

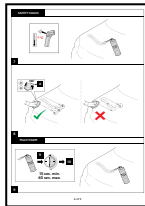

## SYMBOLS



Latest Version  
SCAN HERE



## INSTALLATION CONDITIONS



Latest Version  
SCAN HERE

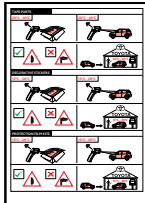

# INSTALLATION INSTRUCTIONS

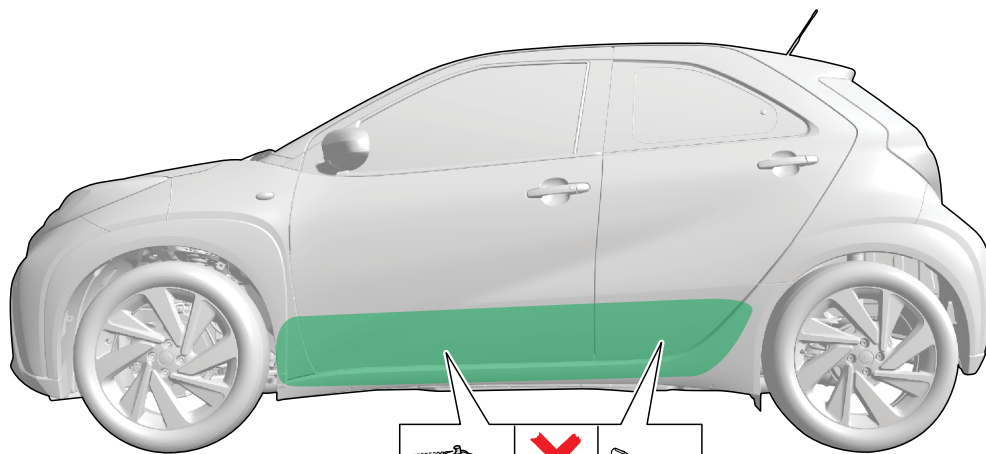

1

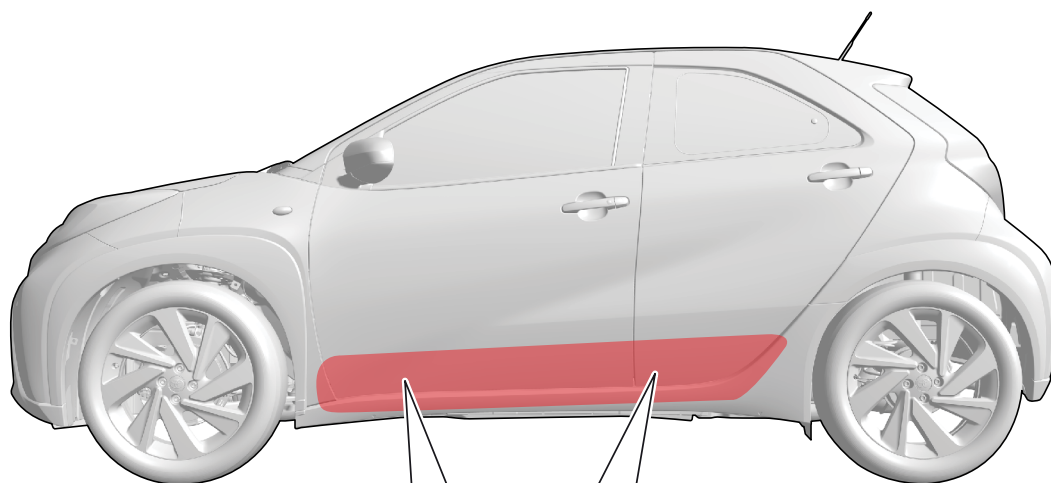

2

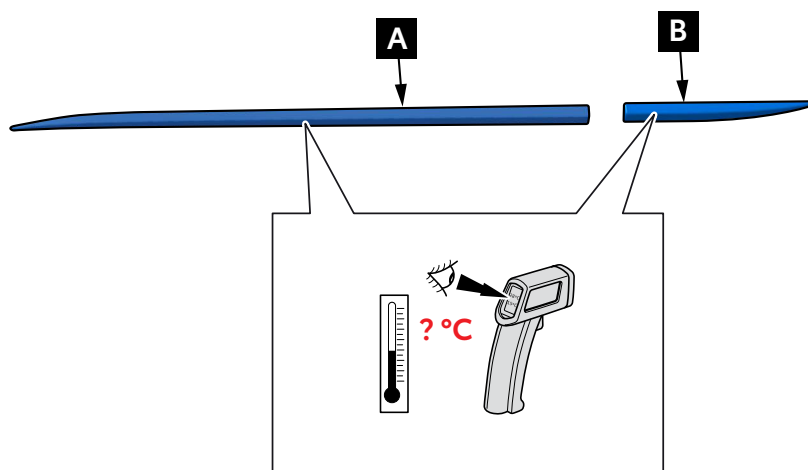

3

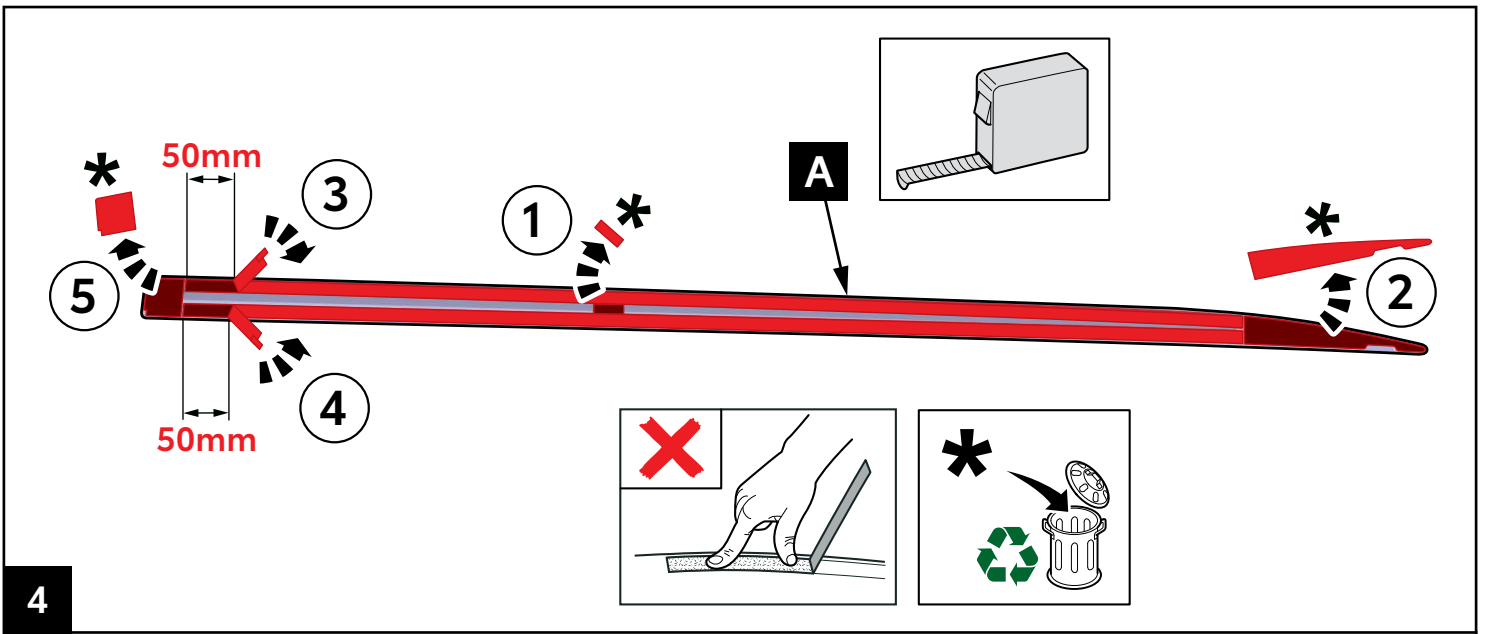

4

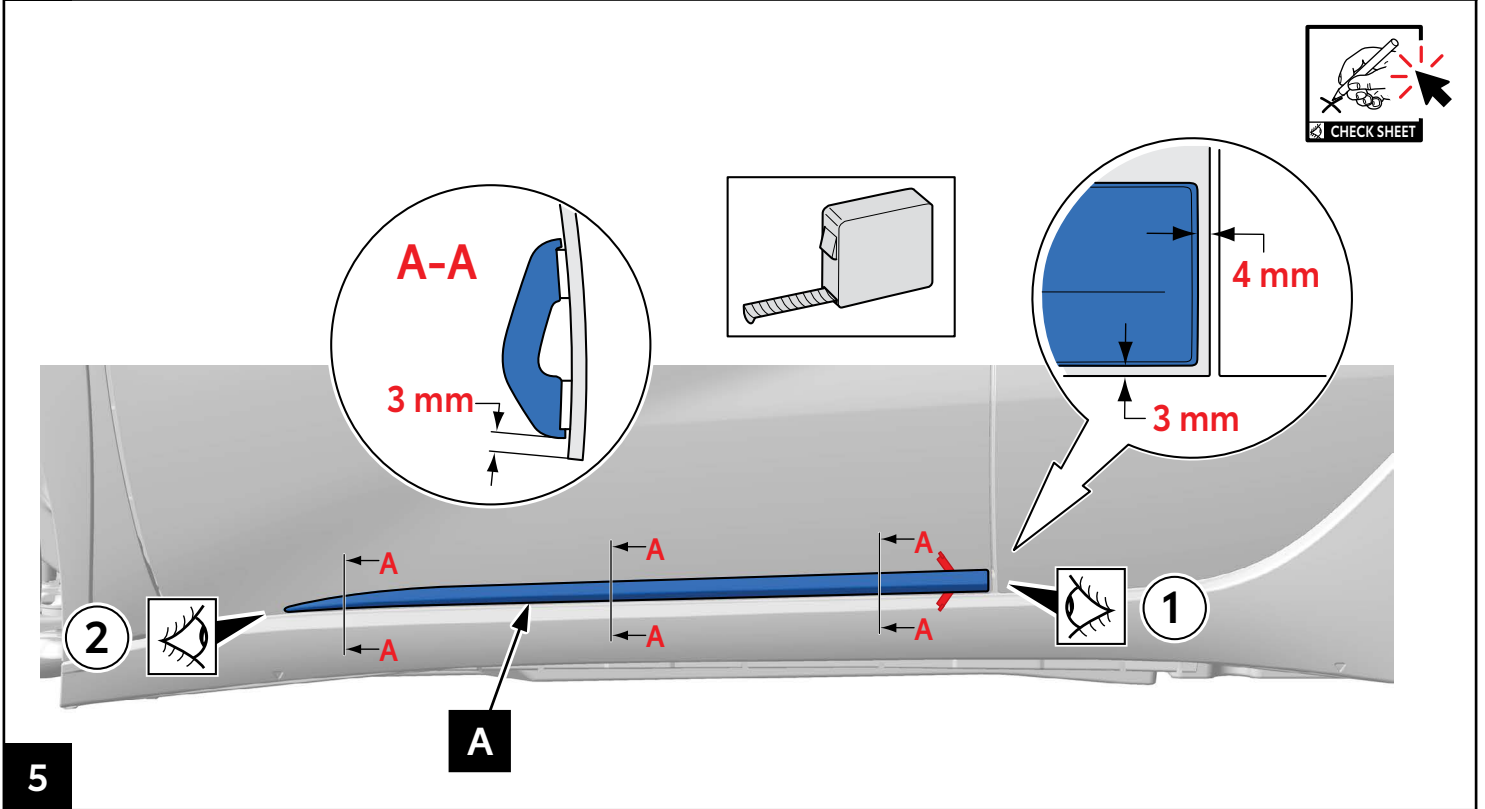

5

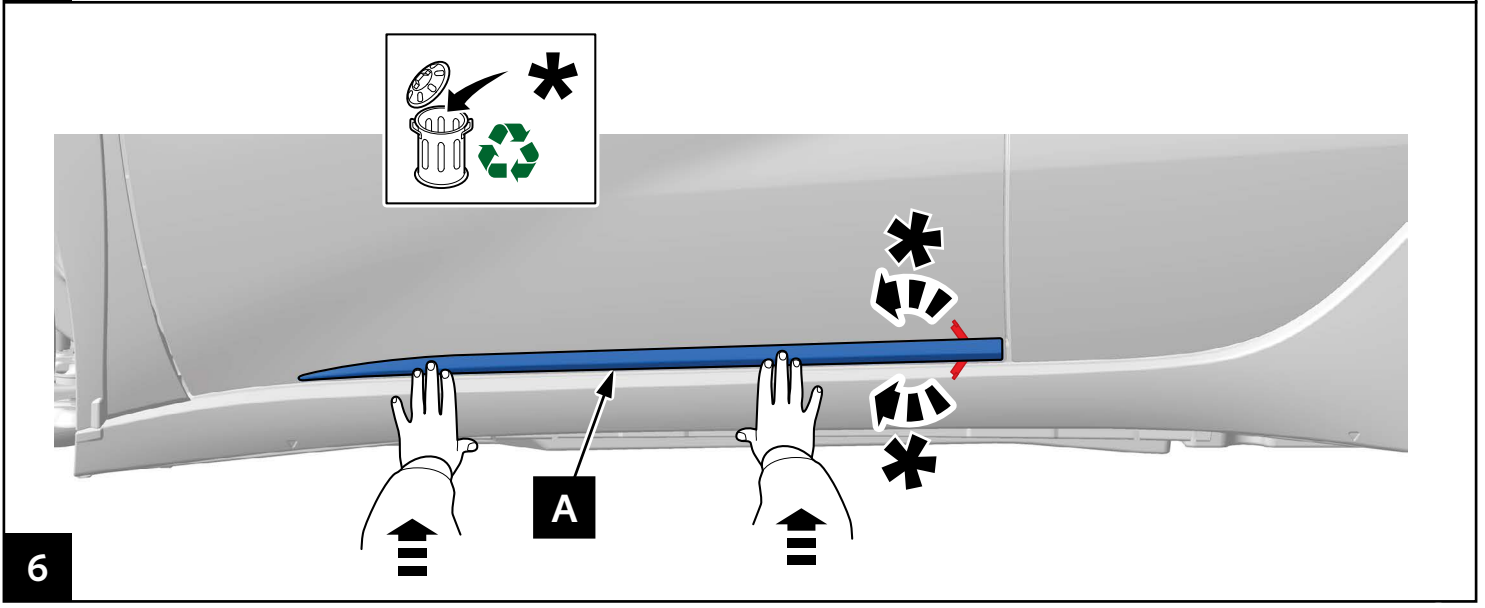

6

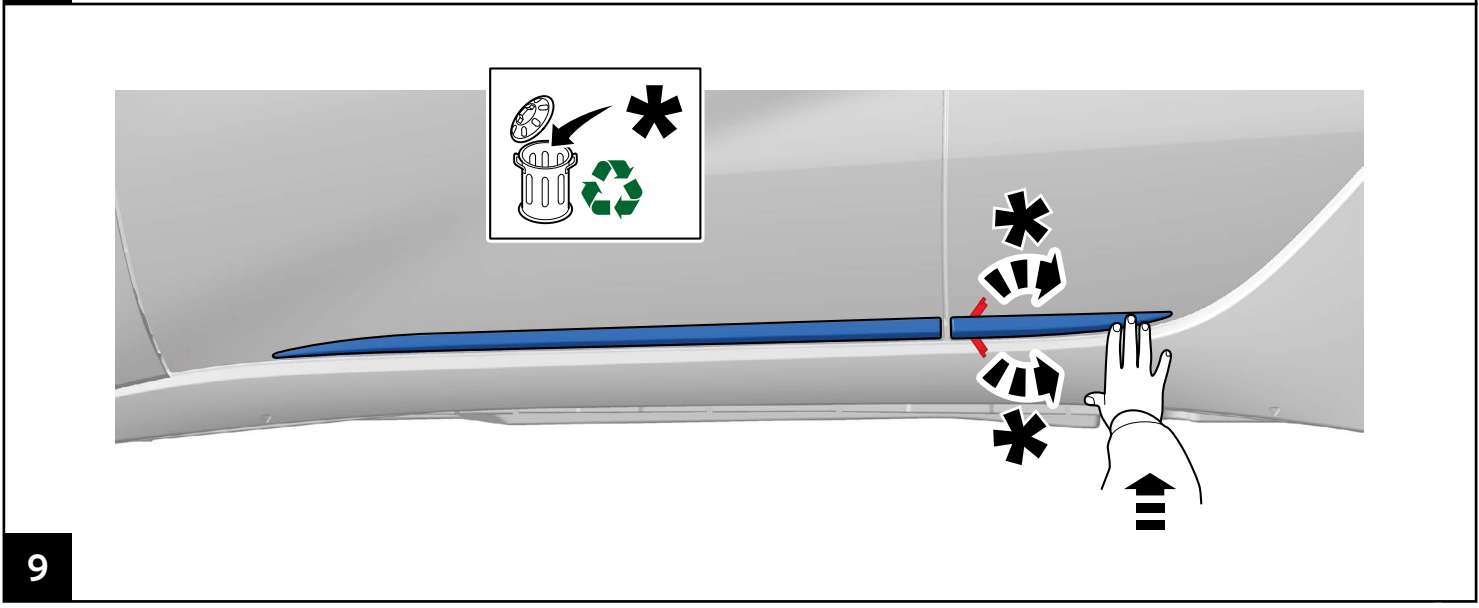
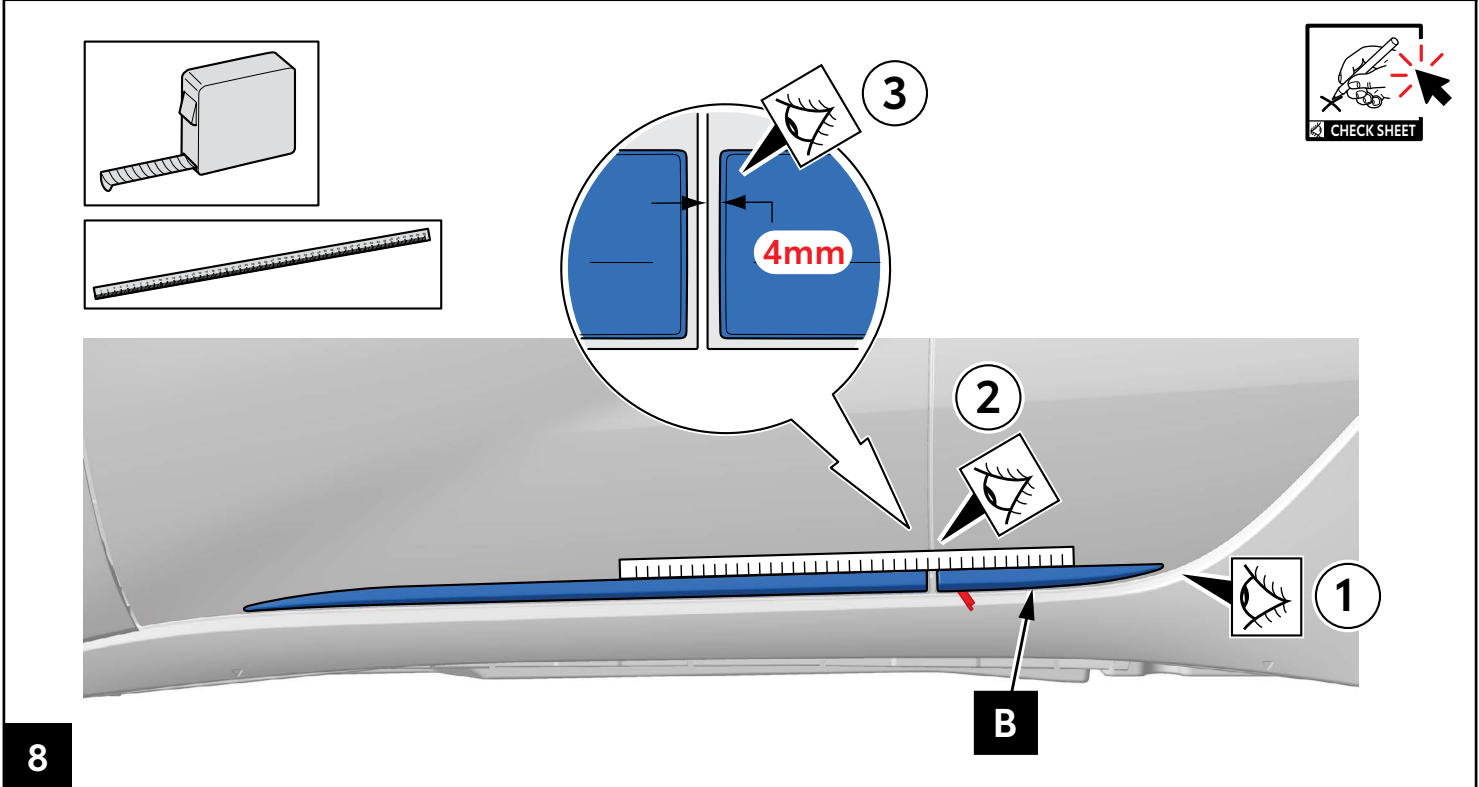
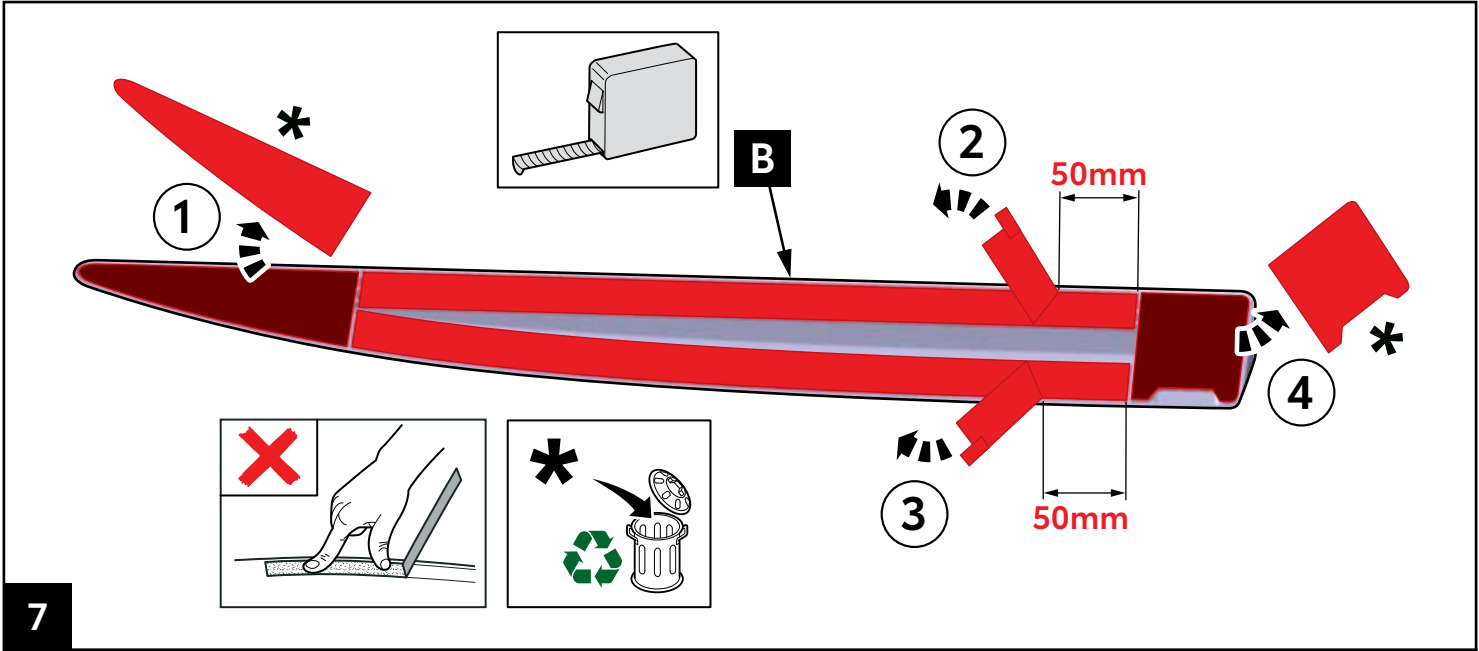



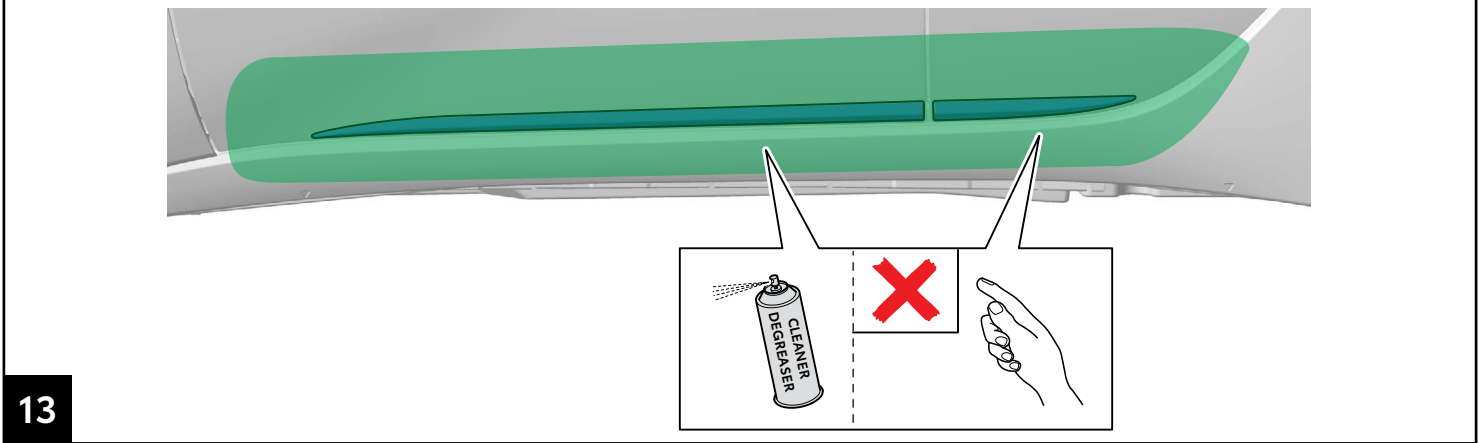
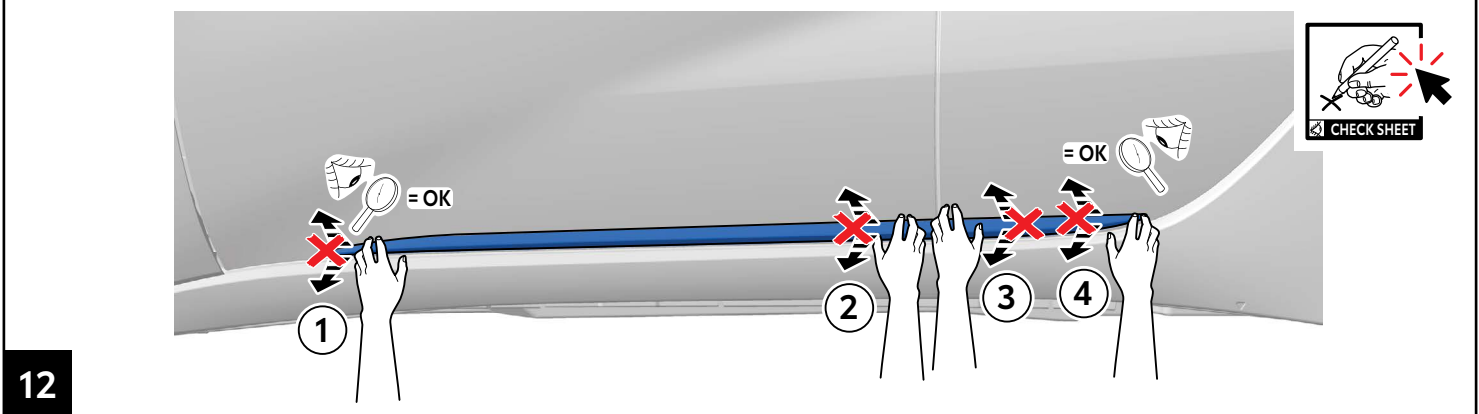
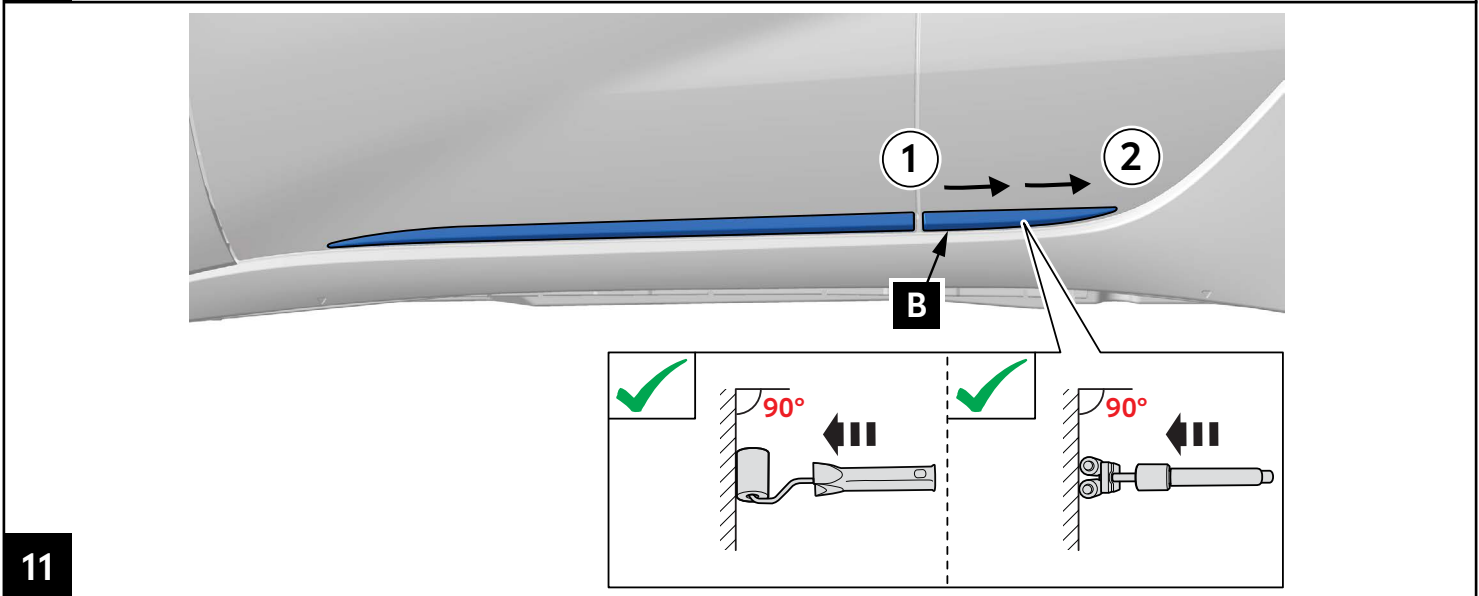
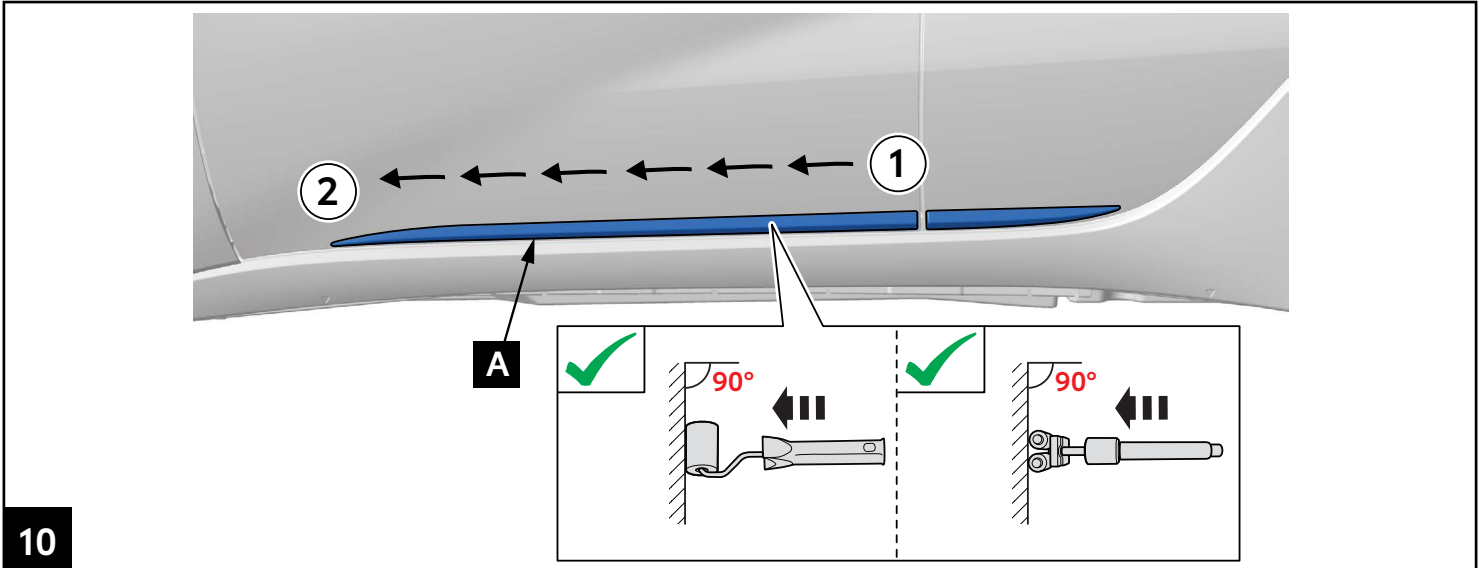

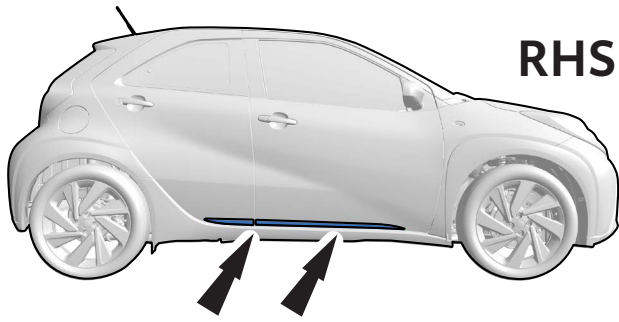

RHS = LHS

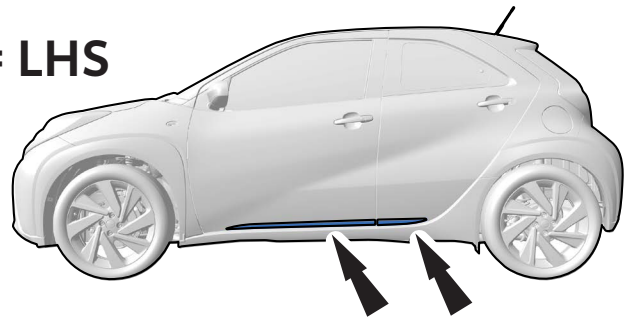

14

### INFORMATION

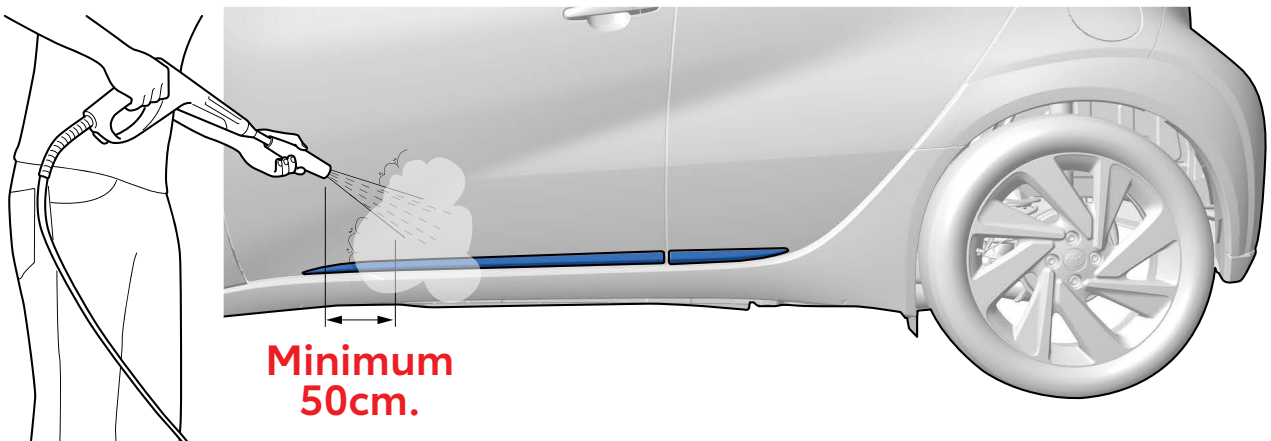
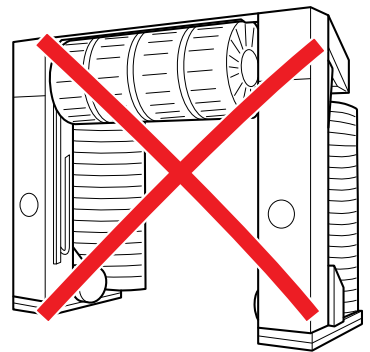
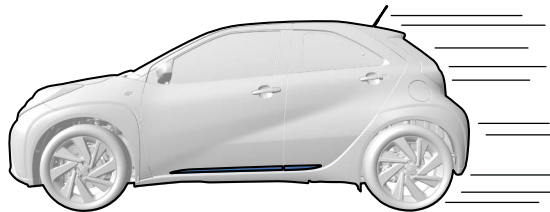
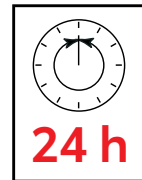
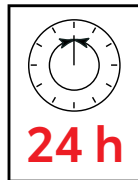
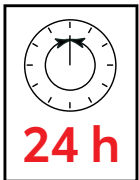

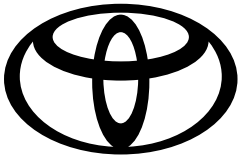

# CHECK SHEET

Page 1 of 3

Model/Year

AYGO X  
As from 2021/09

Side Sills

VINn°

## DURING INSTALLATION

= OK

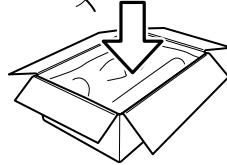

P/N = OK



1

## AFTER INSTALLATION

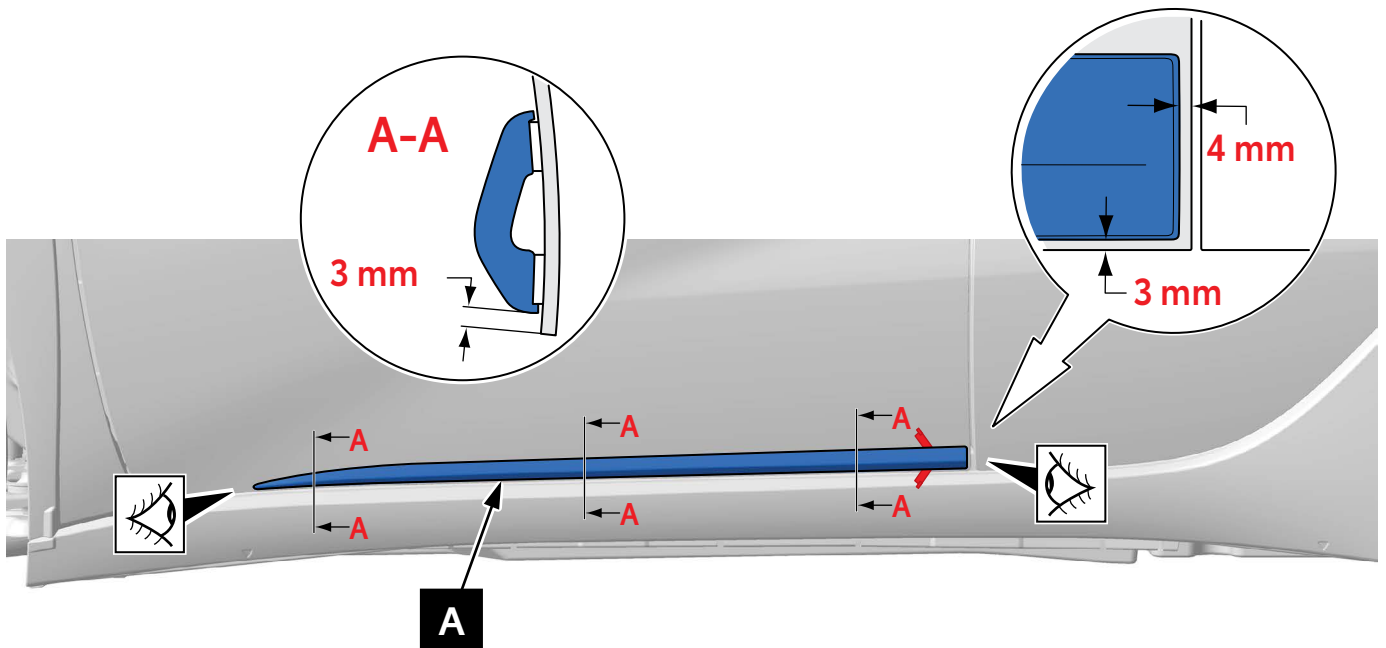

1



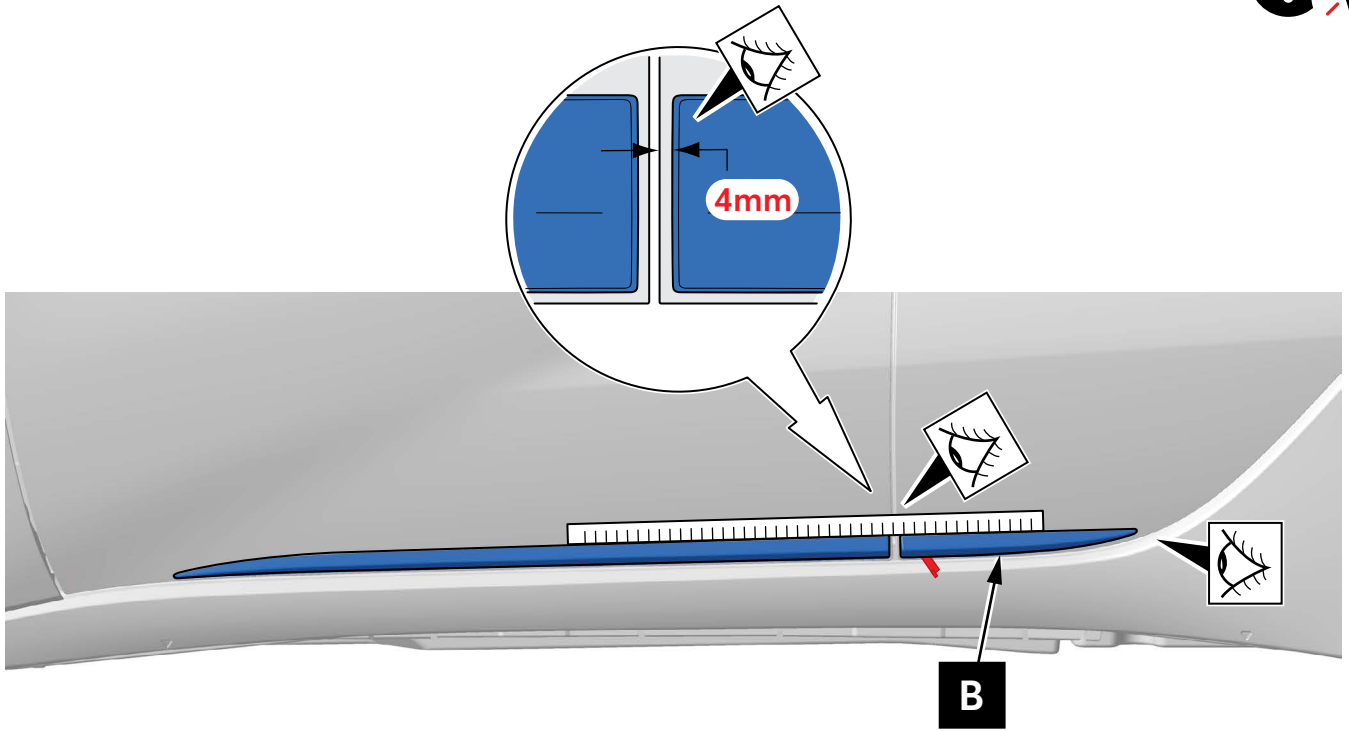

**2**

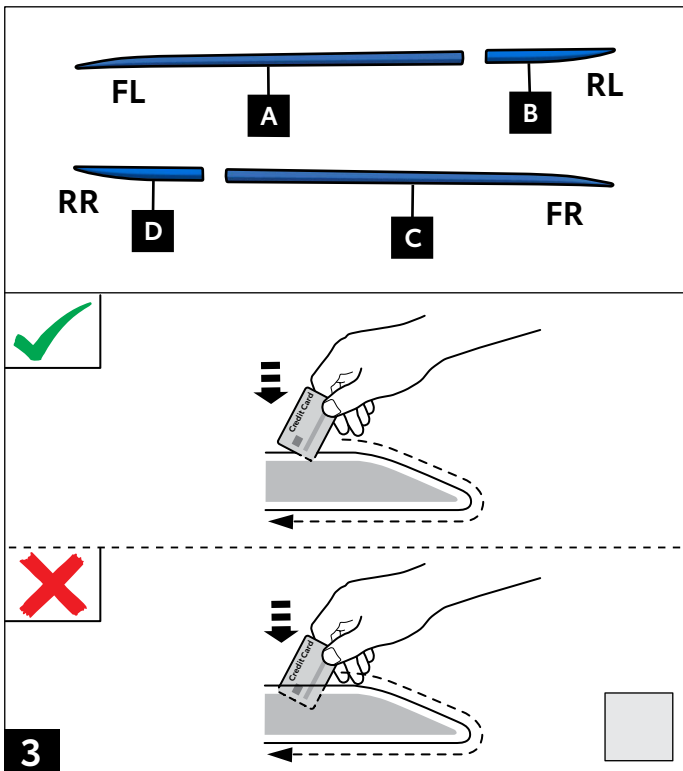

**3**

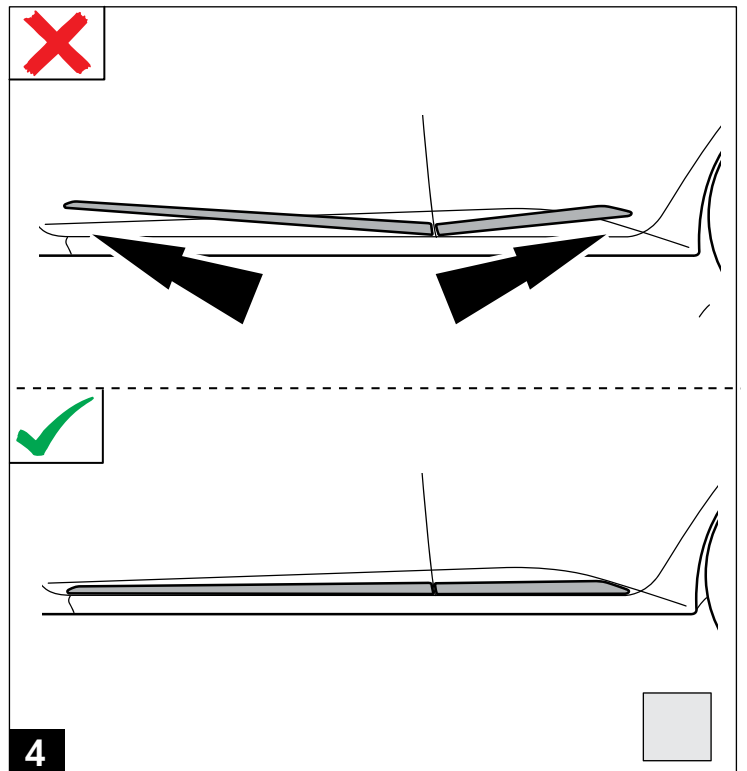

**4**

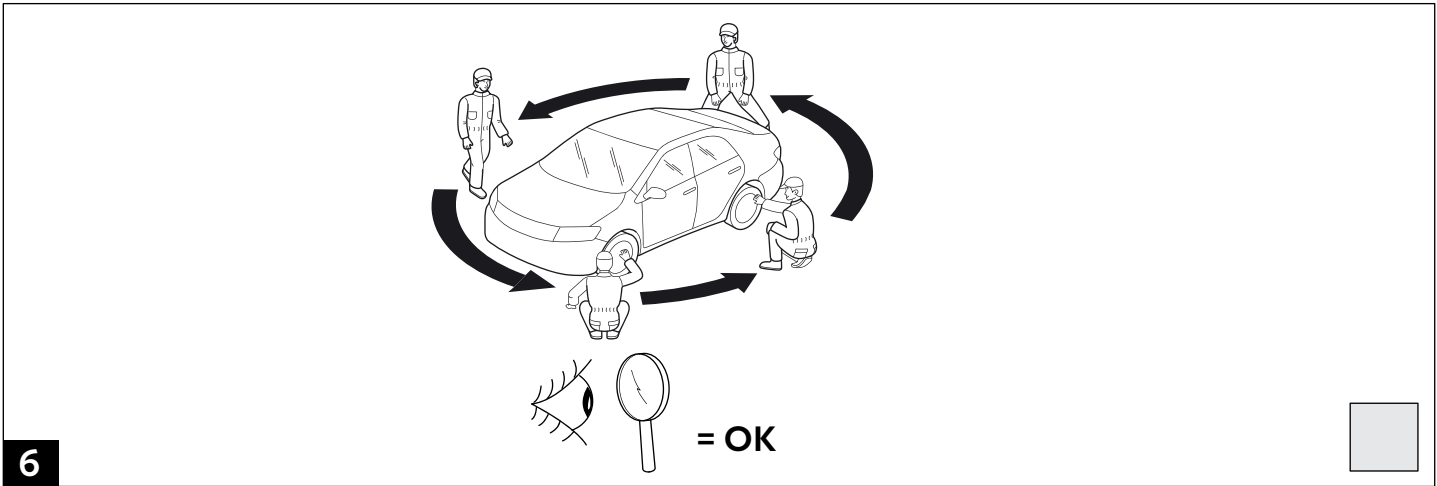
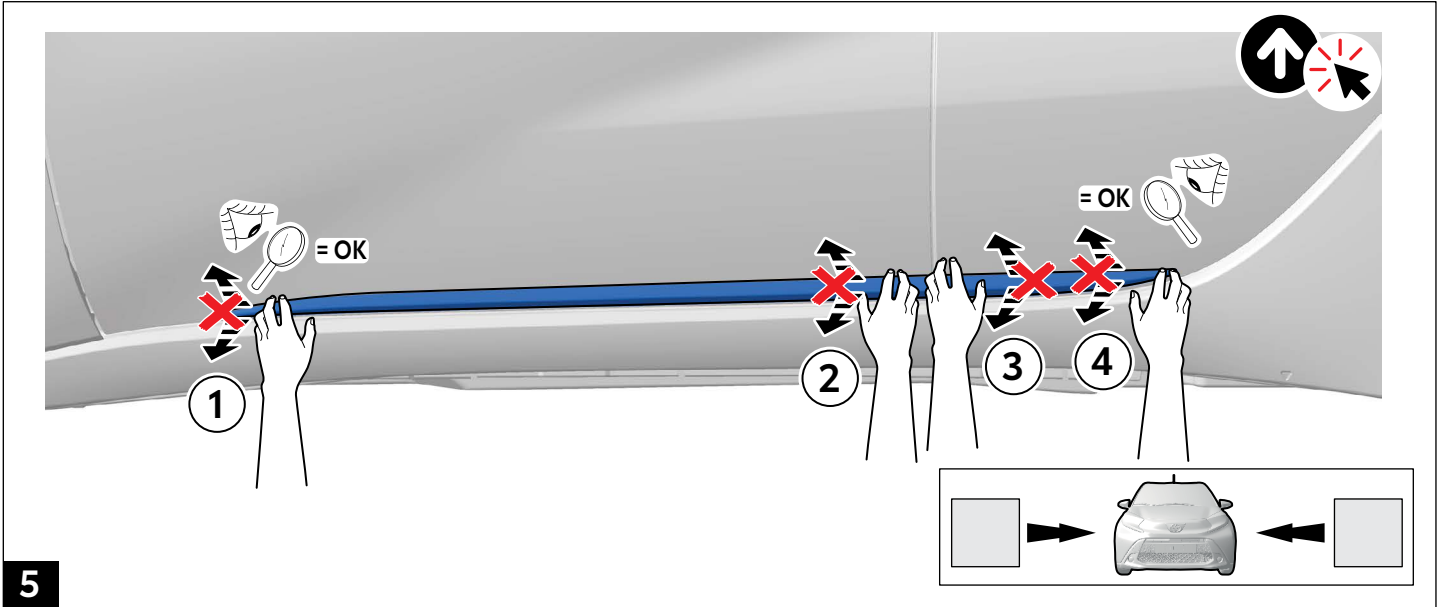

Installation Date:

. . / . . / . . . .

Technician Name & Signature:

Stamp: