

Front & rear set mudflaps INSTALLATION INSTRUCTIONS NX

Model year	As from 2021/09
Vehicle code	*AZ*2**-AW*L*W
Part number	PK389-78N00-EP (STANDARD) PK389-78N10-EP (F-SPORT)

Revision Record

Rev. No.	Date	Page	Steps	Remarks
△ ₁	17-01-2022	9	1	Area of „0 mm“ updated.

KIT CONTENT

A

PK389-78N00-F1
PK389-78N00-TF

1x

1x

C

K2325

4x

D

2x

B

PK389-78N00-R1
PK389-78N00-RF

1x

1x

C

K2326

6x

D

6x

TOOLS & CONSUMABLES / PPE

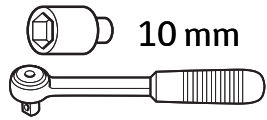

10 mm

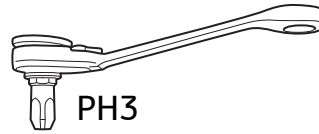
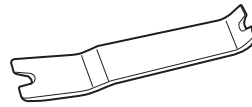

PH3



AIM 003-517-*

INFORMATION



MSDS

Material Safety Data Sheet



TDS

Technical Data Sheet

INSTALLATION INSTRUCTIONS

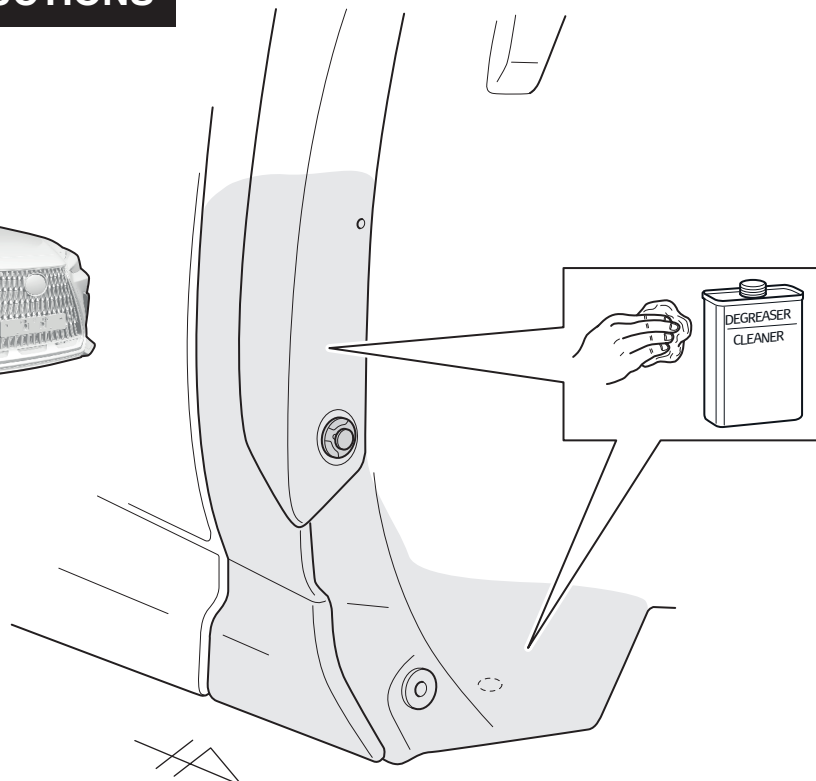
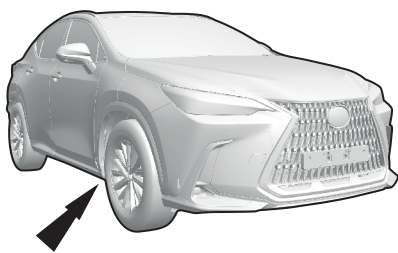

1

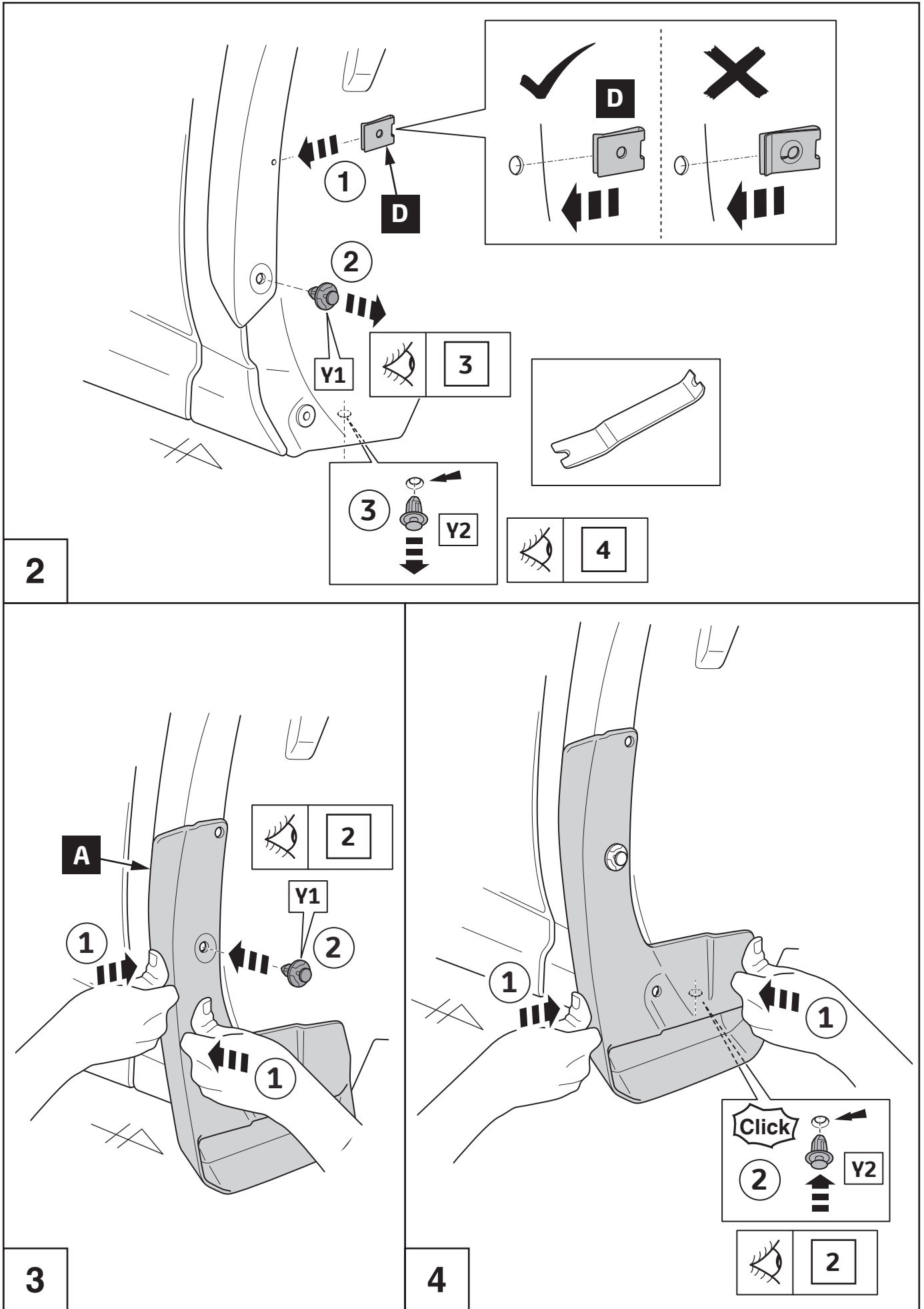

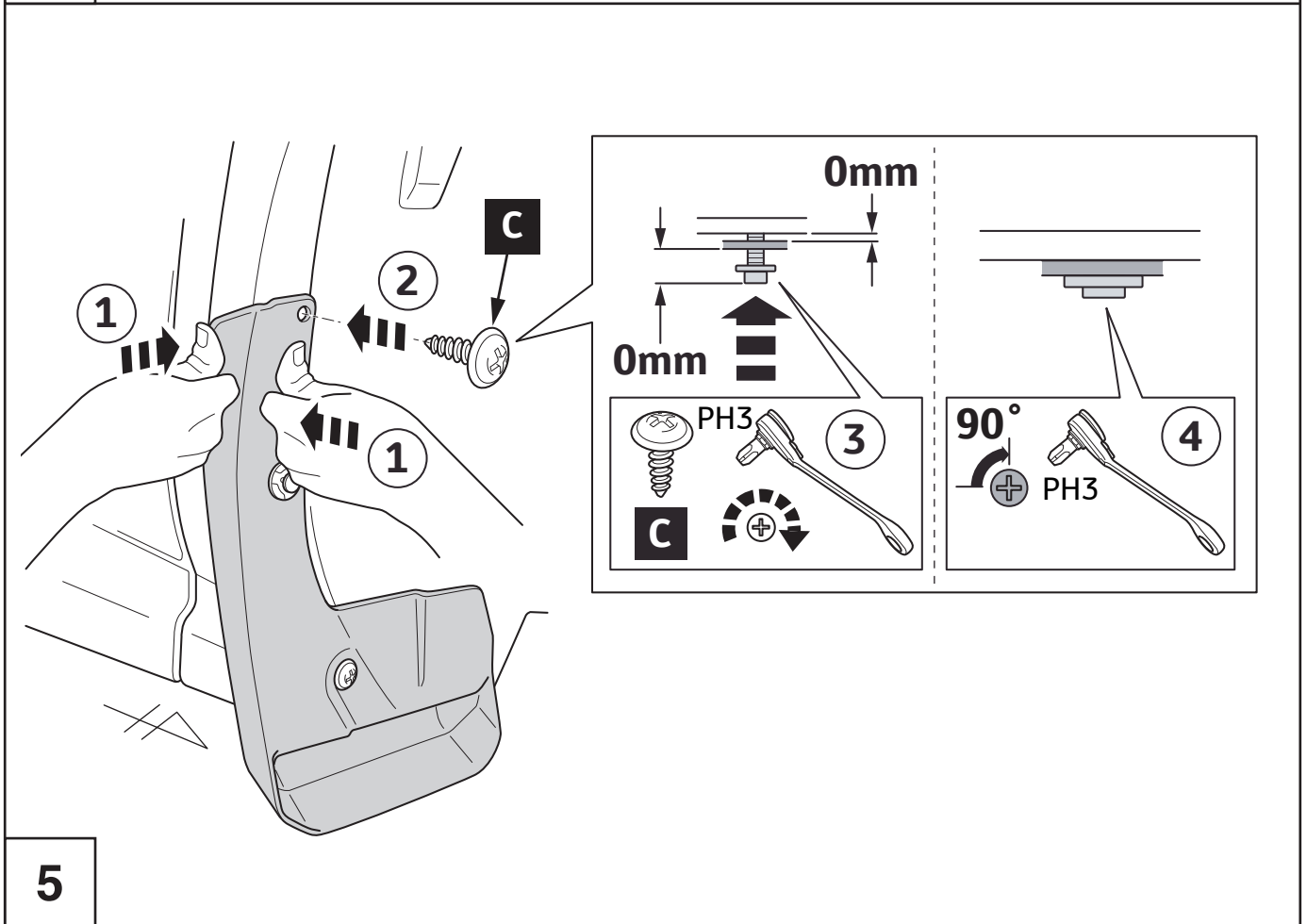
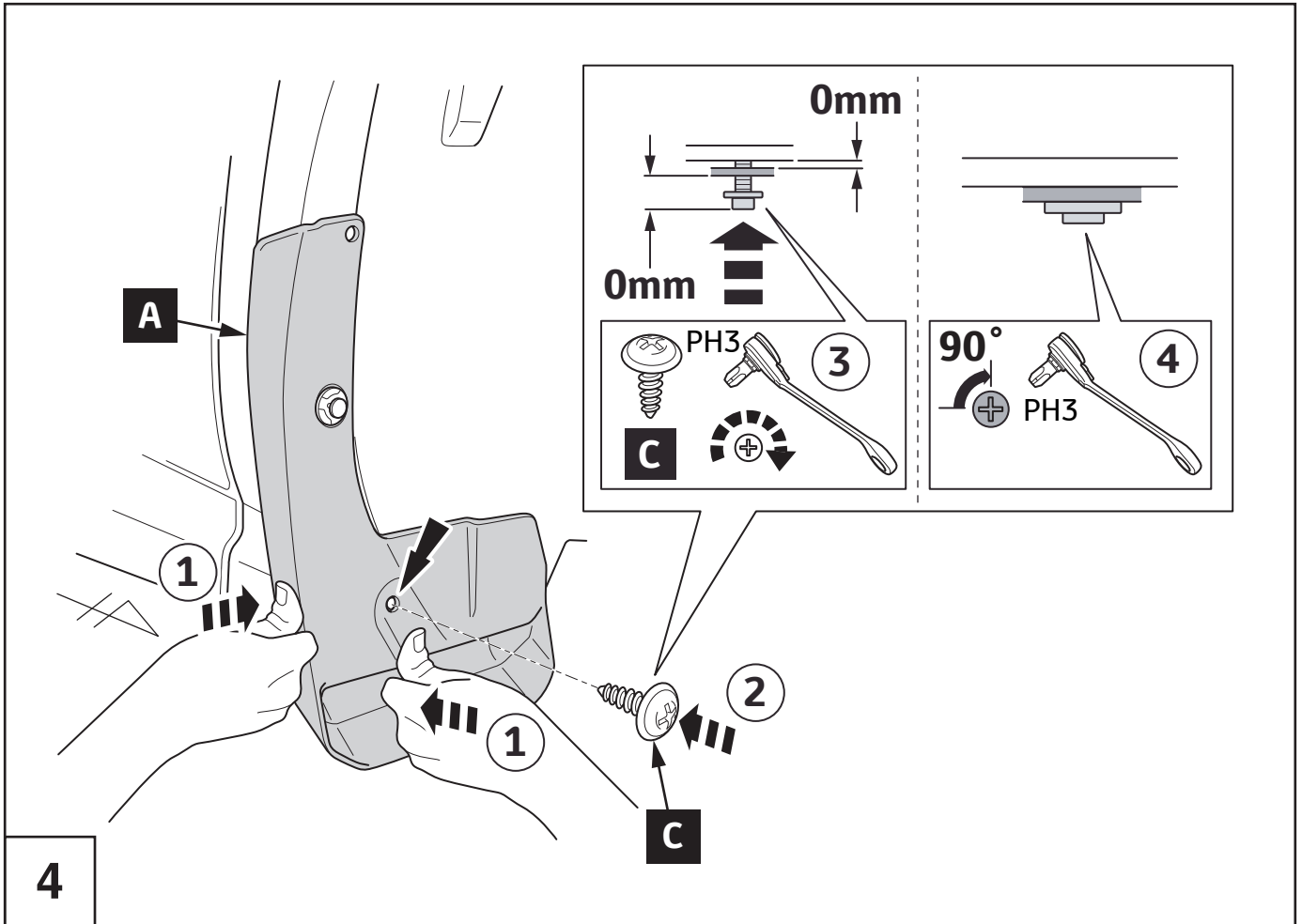

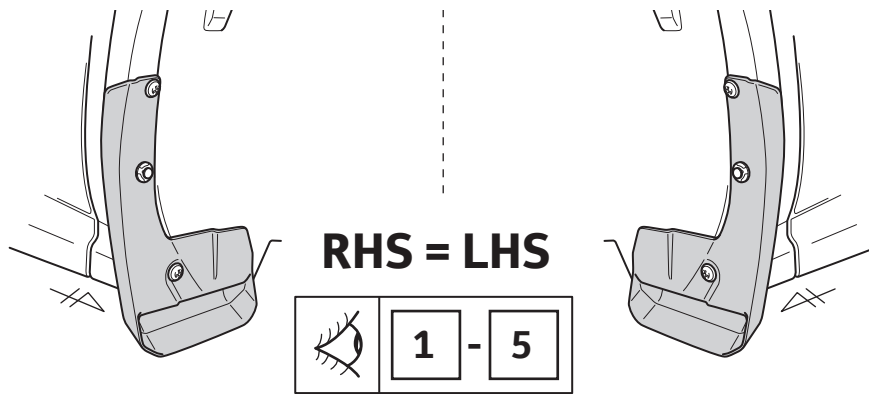

6

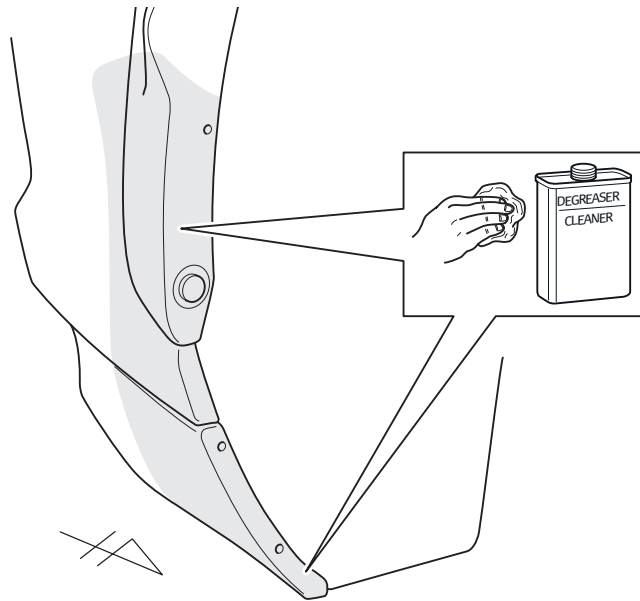

7

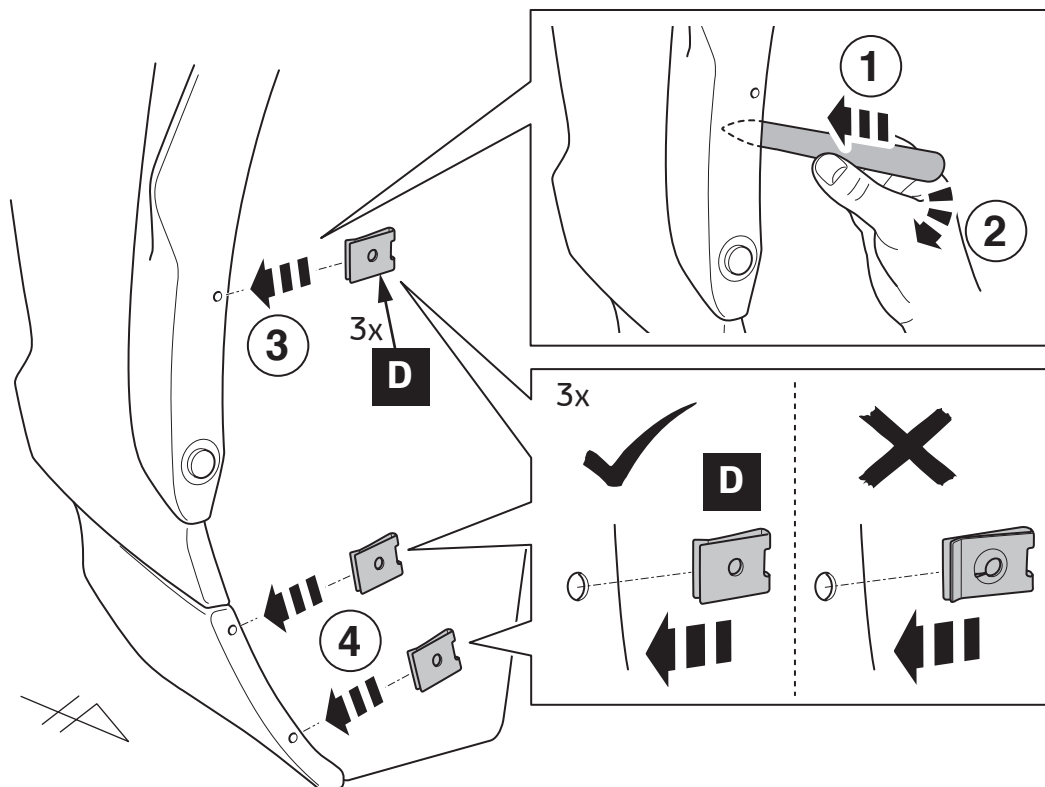

8

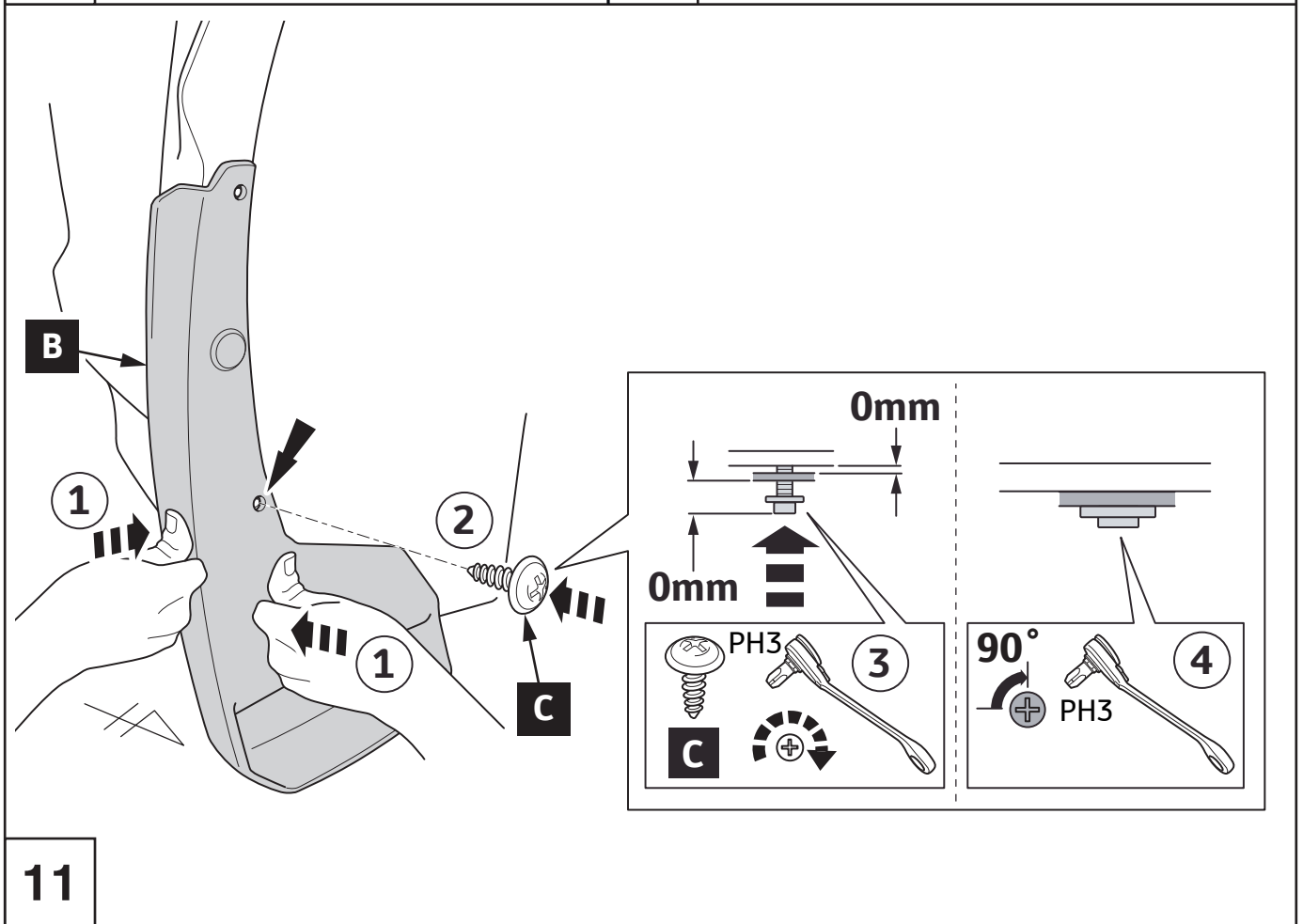
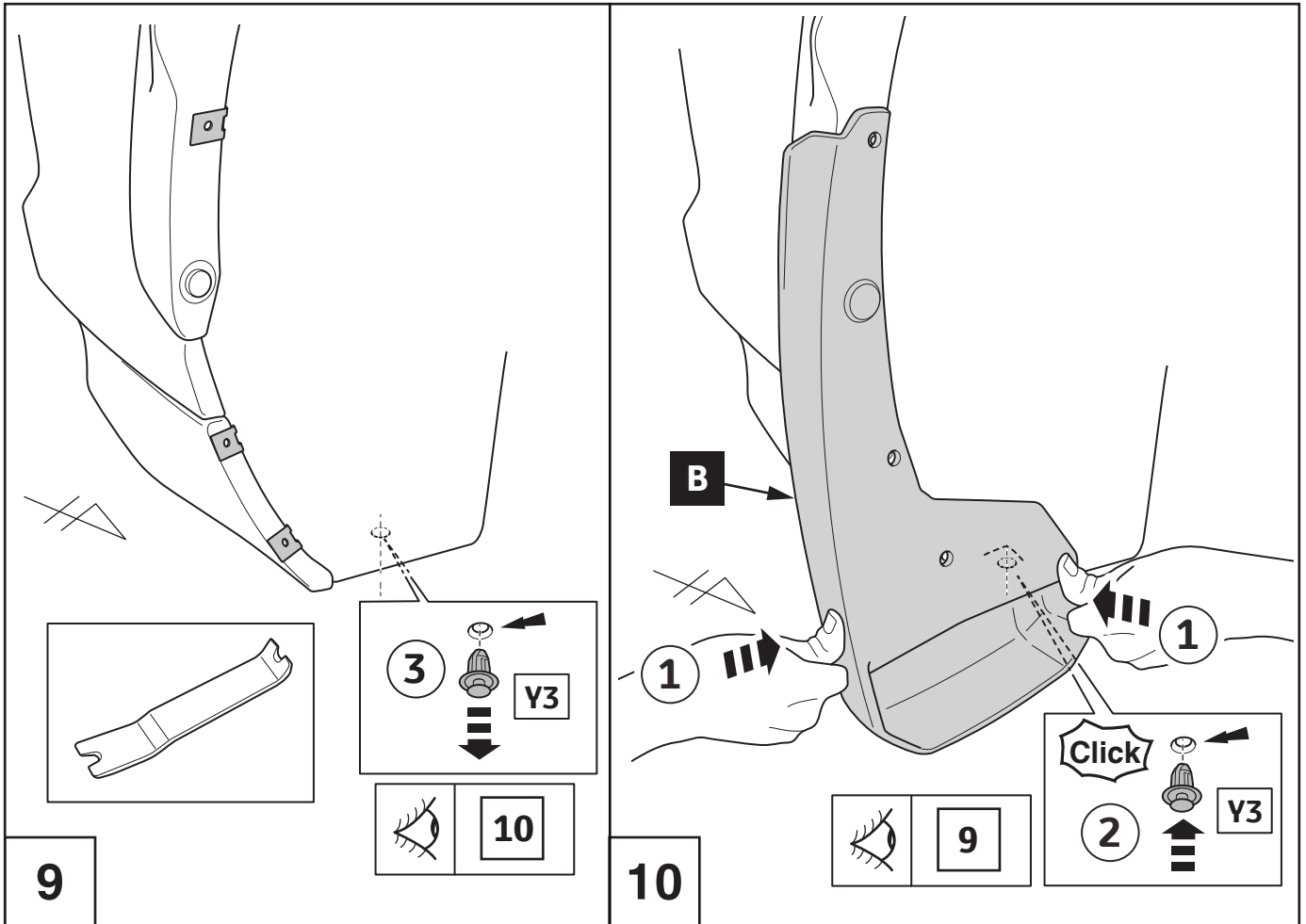

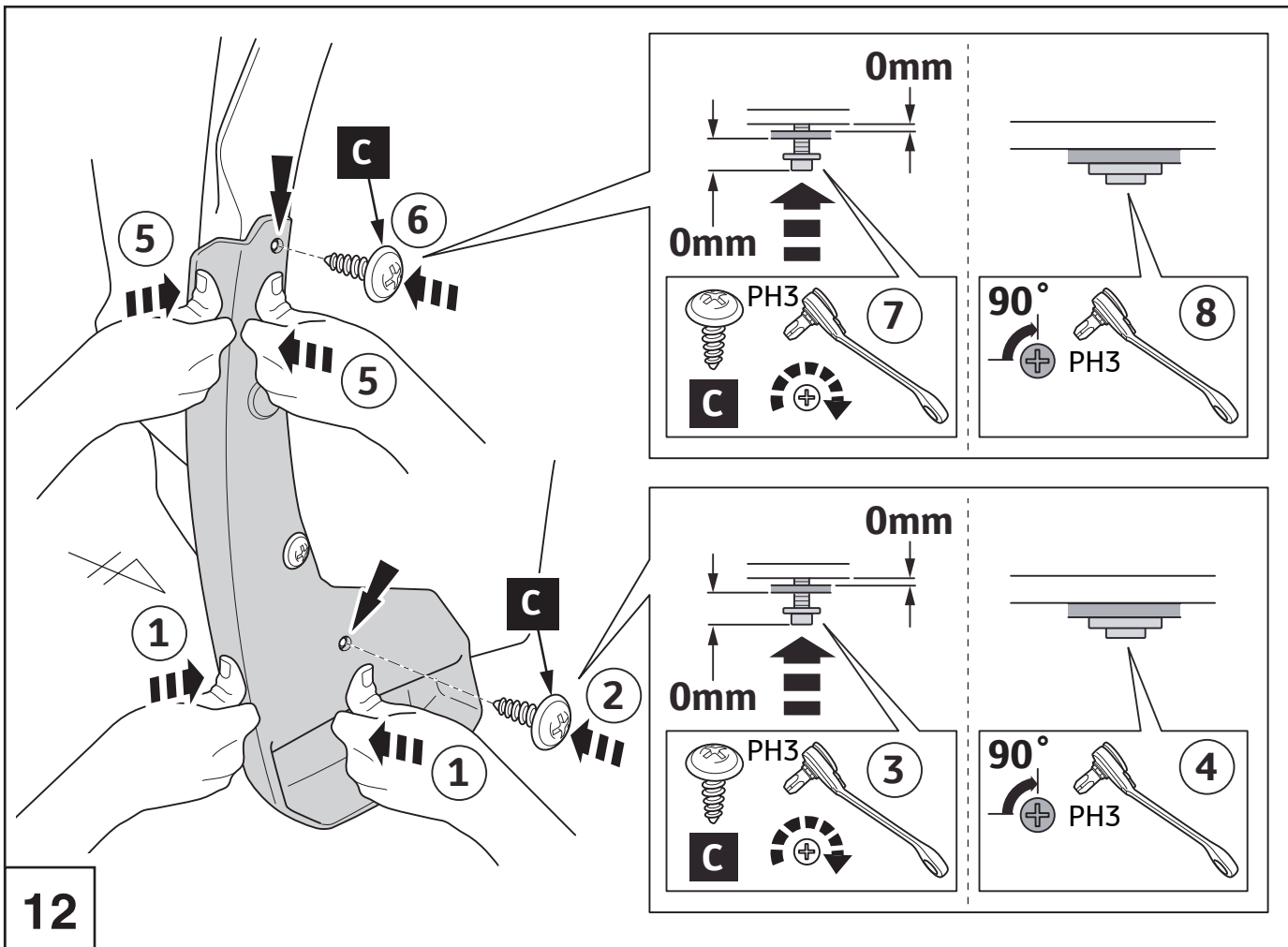

12

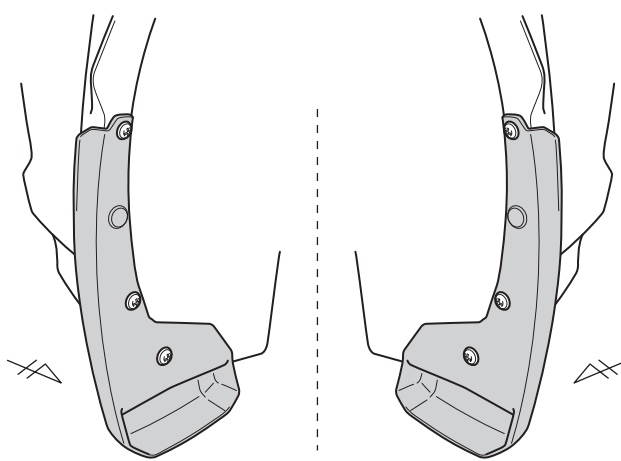

RHS = LHS

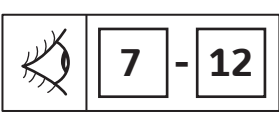

13

Model / Year **NX** As from 2021/09

Front & Rear Mud flaps

VIN n°

DURING INSTALLATION

1 P/N = OK

2 **LHS** **RHS**

3 **LHS** **RHS**

AFTER INSTALLATION

1 0mm **= OK**
LHS **RHS**

2 **= OK**

Installation Date:
 . . / . . /

Technician Name & Signature:

Stamp: