



**TOYOTA**

ALWAYS A  
**BETTER WAY**

# All Models

## Long Life Body Protector







Installation Instructions

Part number: PZ41A-BP001-80

Manual reference number: AIM 002 616-1

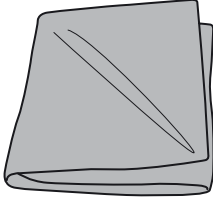
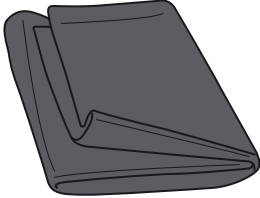
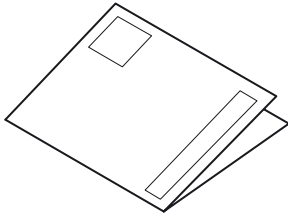
# Revision record

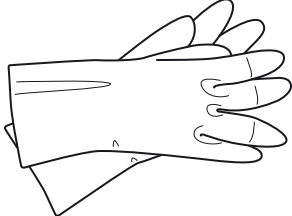
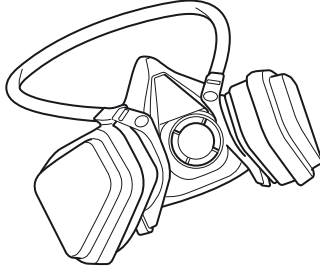
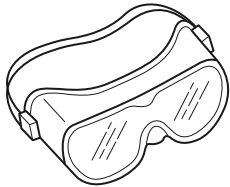
Rev. No.	Date	Page	Picture	Update	New	Deleted steps
1	24-07-2012	3		X		

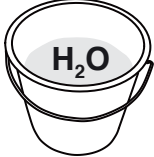
 <b>A</b>	1x	 <b>B</b>	1x
 <b>White</b>	1x	 <b>Yellow</b>	1x
 <b>Grey</b>	1x	 <b>F</b>	1x
 <b>G</b>	1x	 <b>H</b>	1x
 <b>(3x) Microfiber</b>			
		 <b>H<sub>2</sub>O</b>	

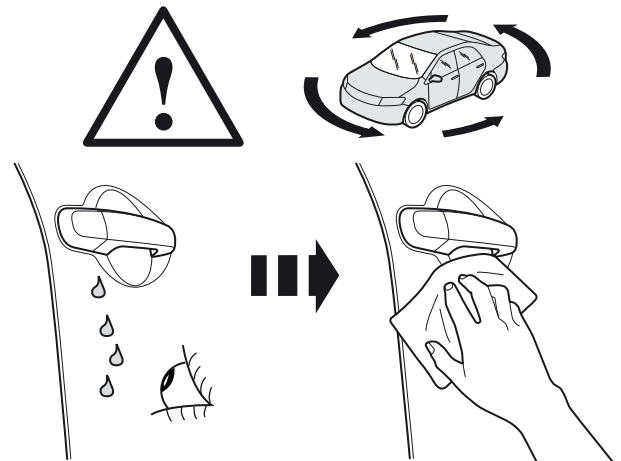
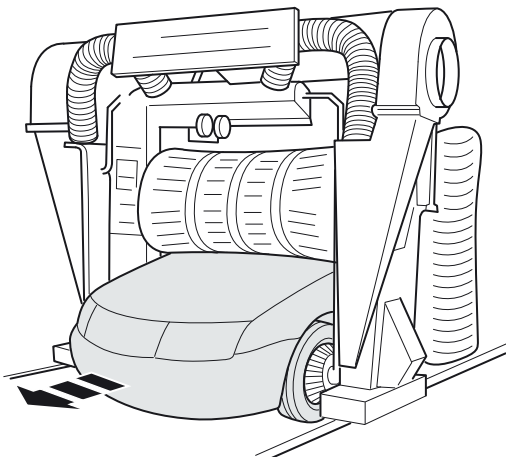
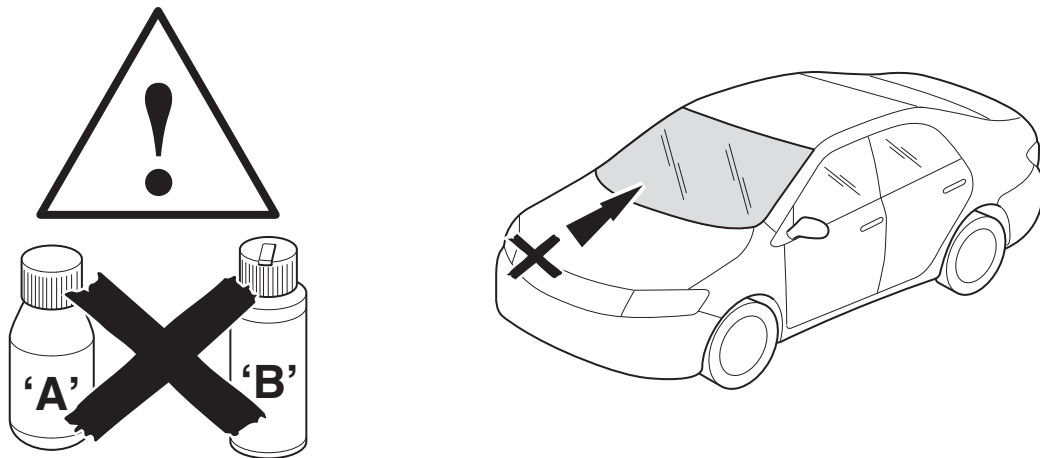
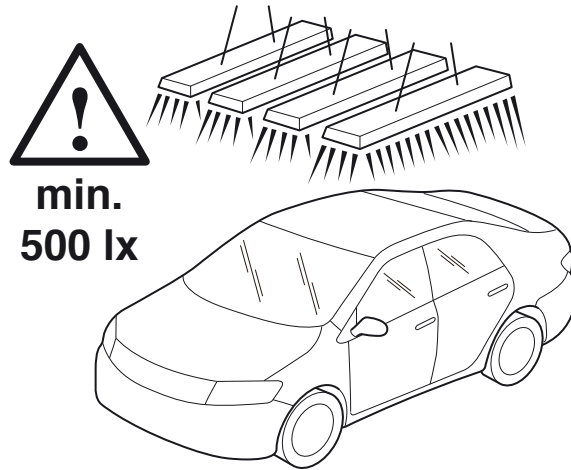
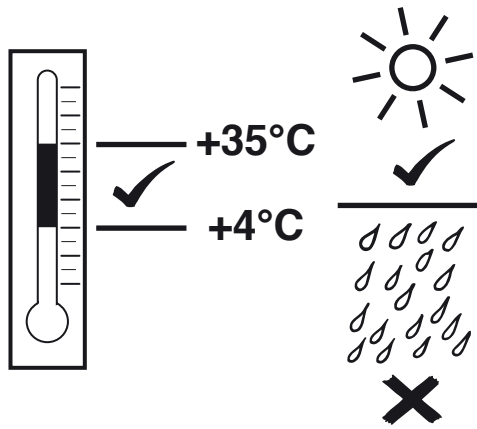

1

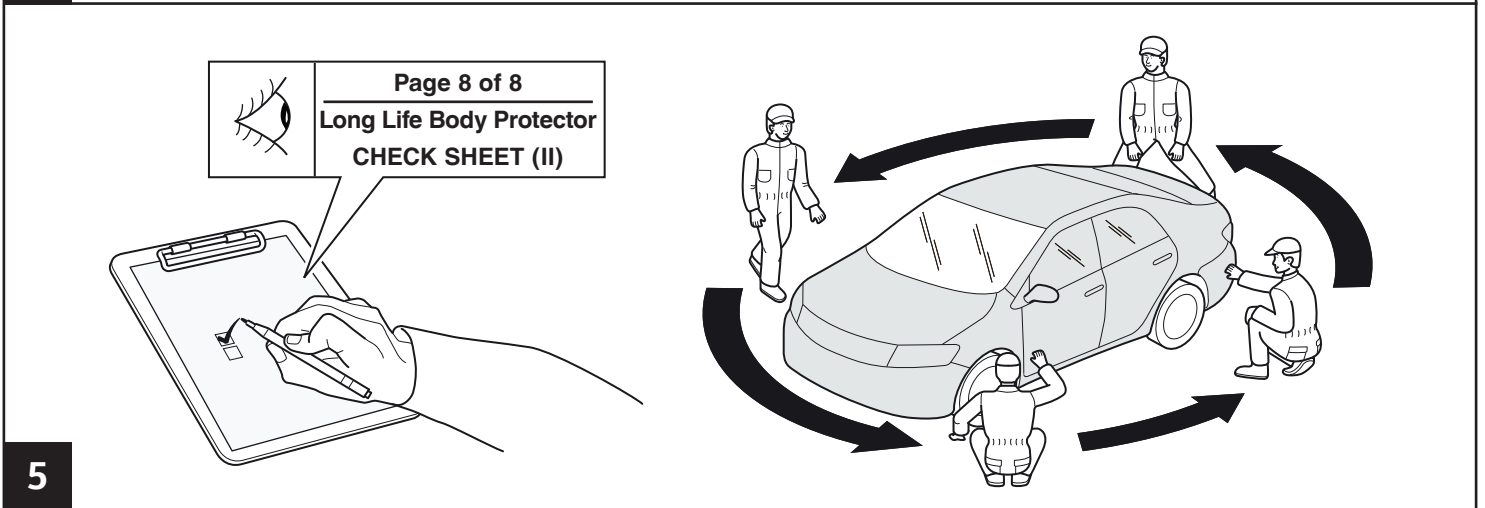
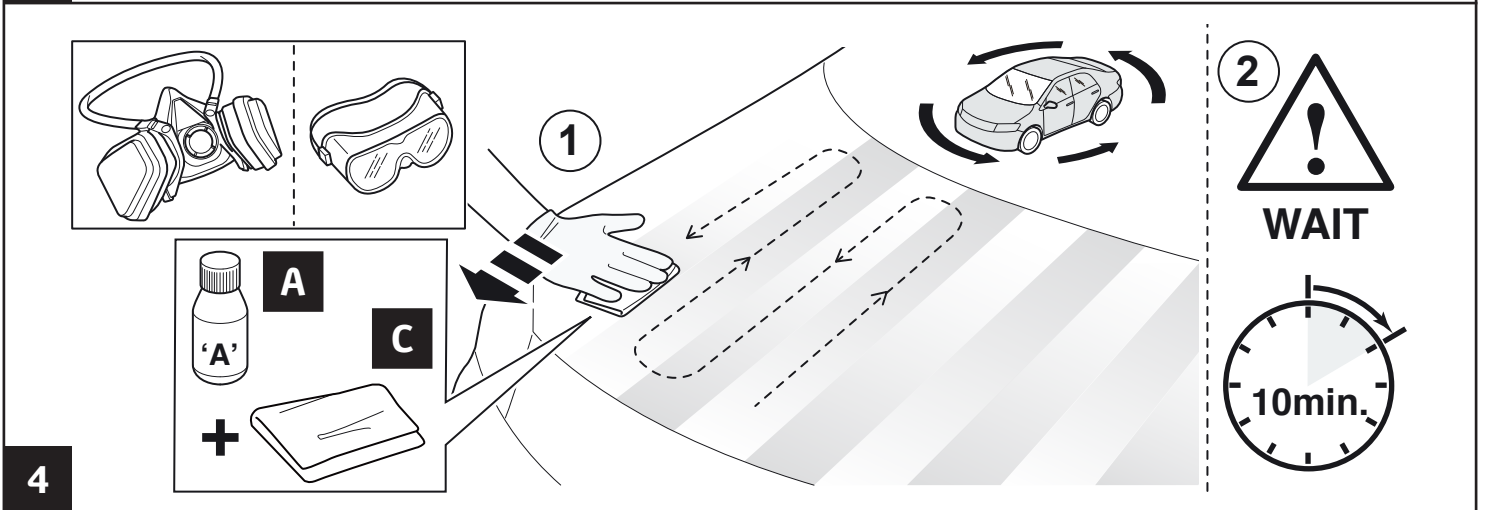
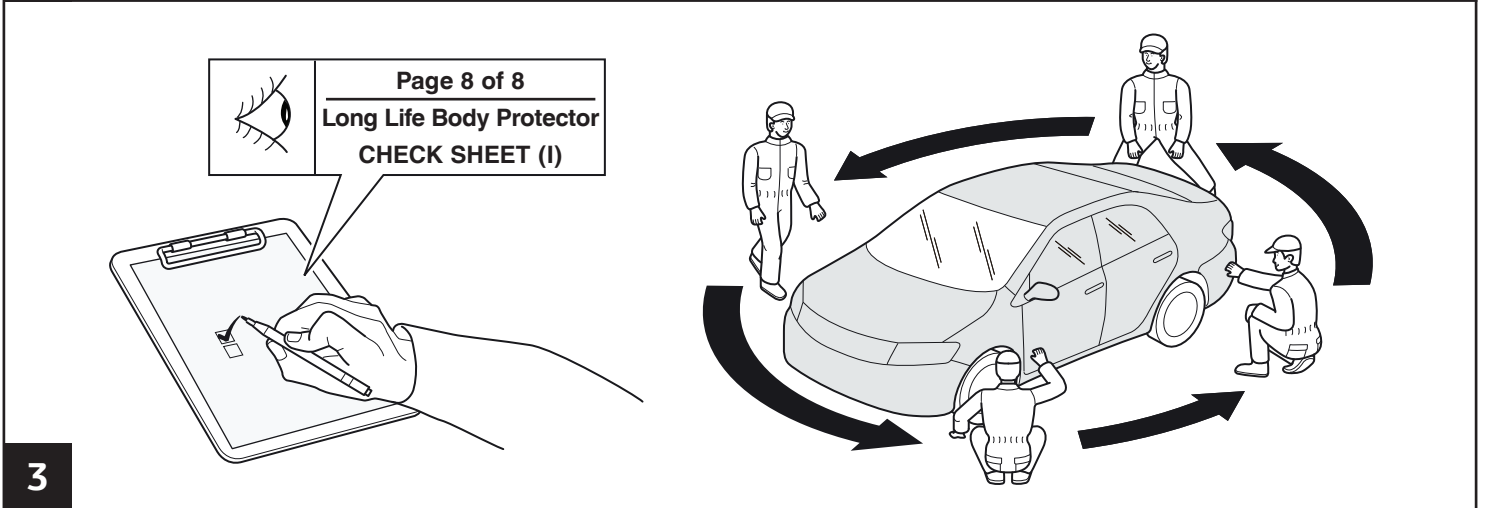
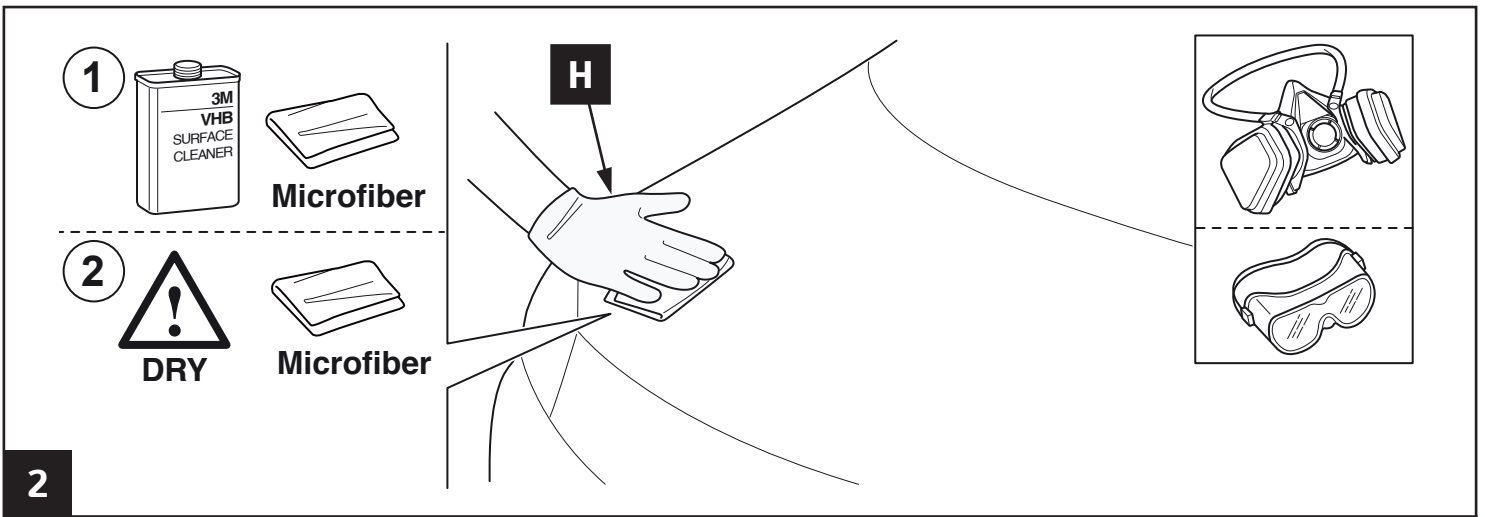

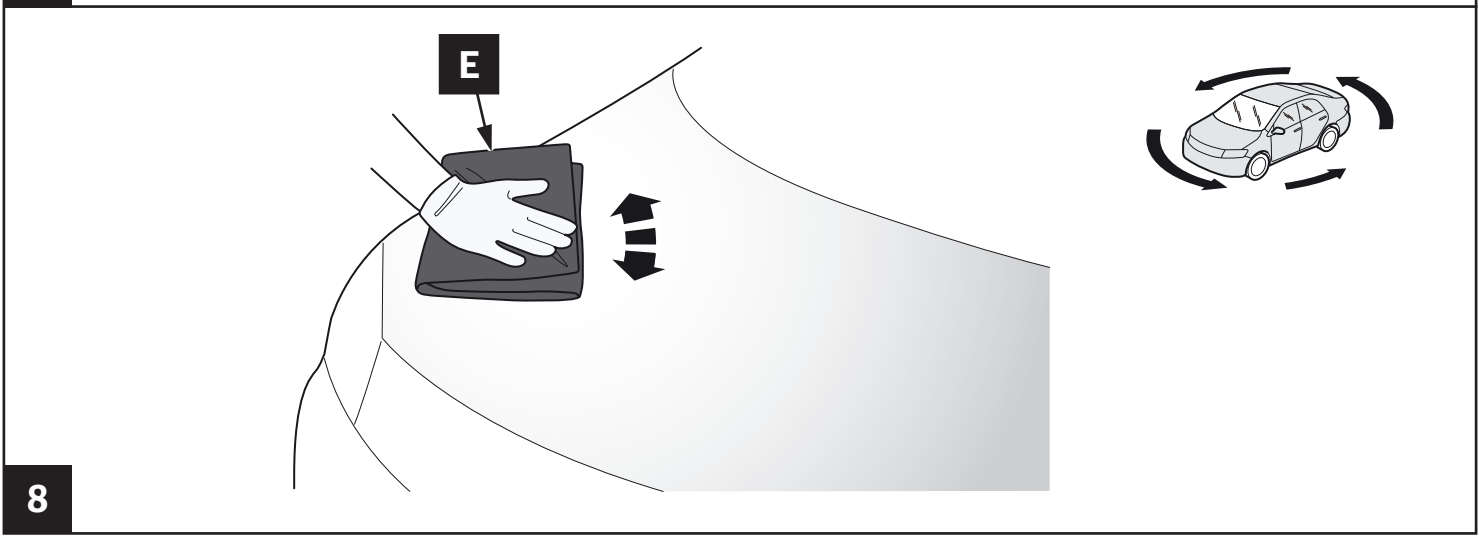
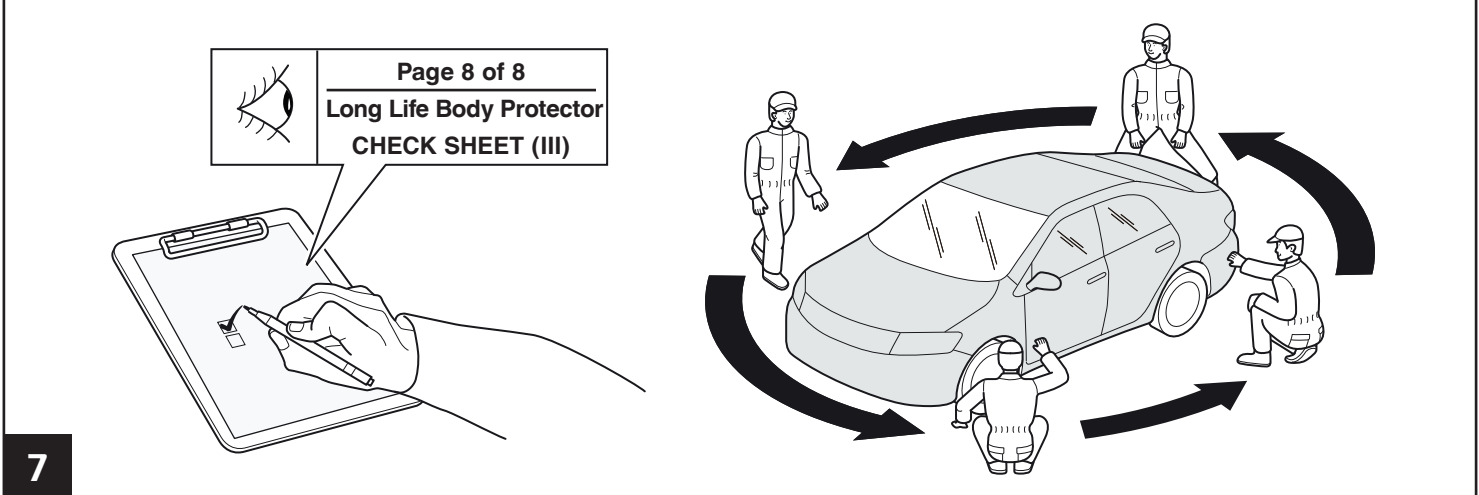
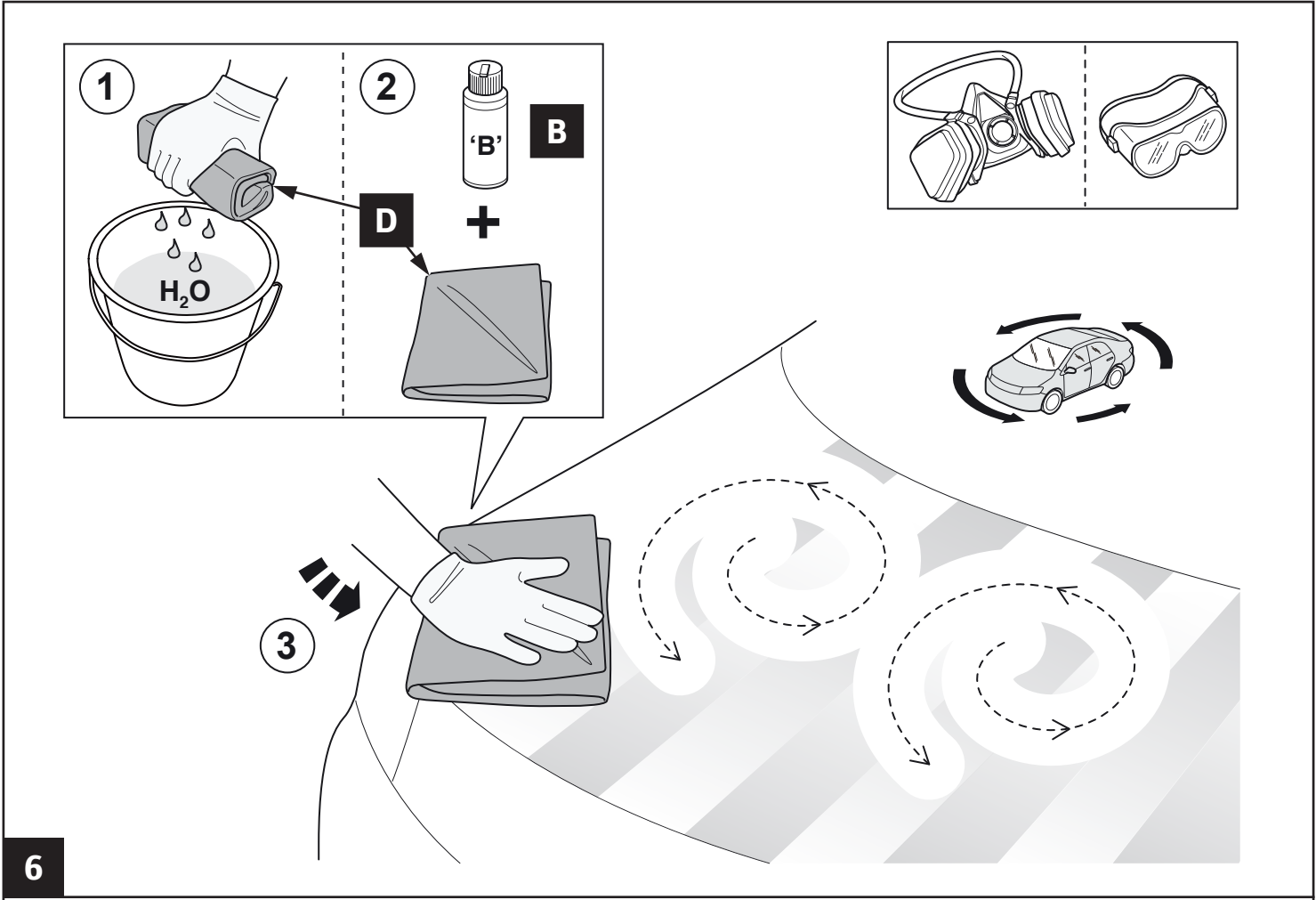

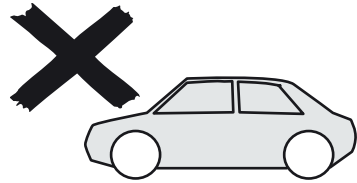
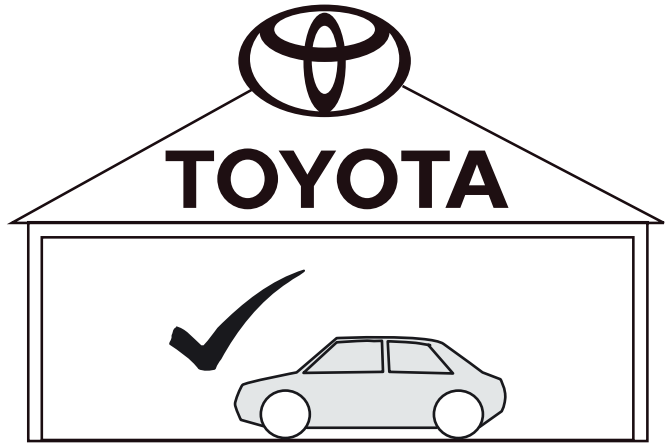

9

Page 8 of 8  
Long Life Body Protector  
CHECK SHEET (IV)

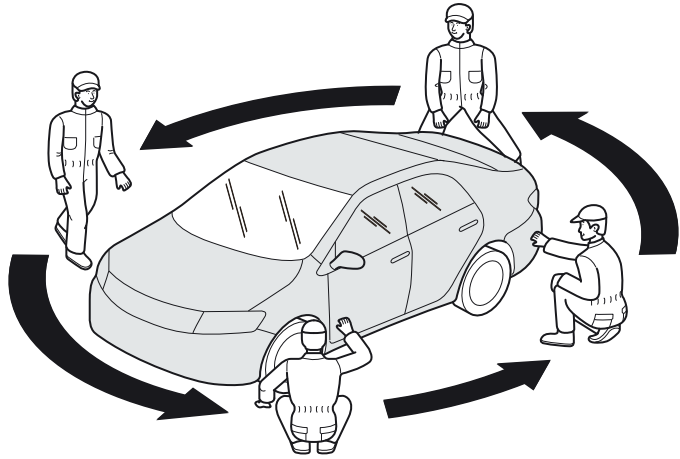

10

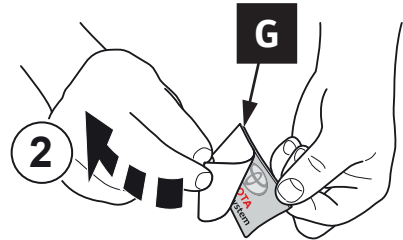
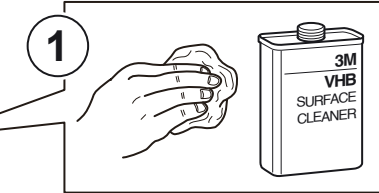
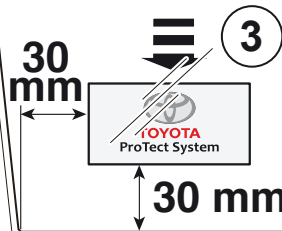
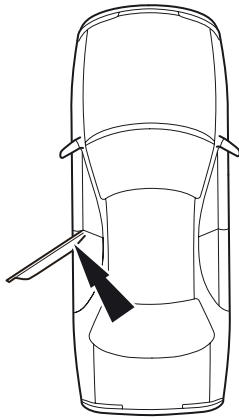

11

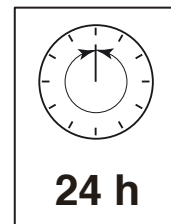
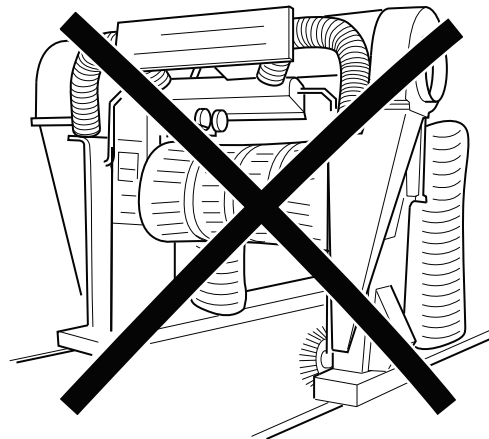

12



# Long Life Body Protector CHECK SHEET



Dealer Name \_\_\_\_\_  
 Technician \_\_\_\_\_  
 Date . . / . . / . . . .  
 VIN n°

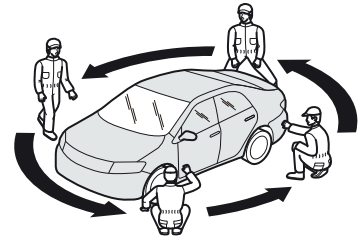

## I. After degrease

dry, no damage and clean

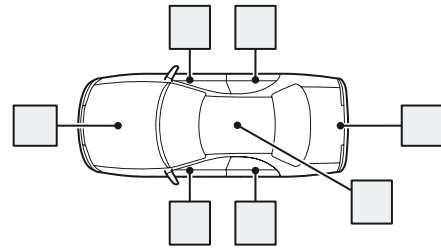

## II. After product 'A'

wipe traces on all areas

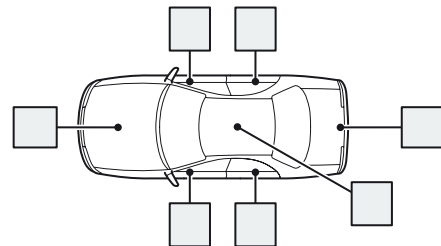
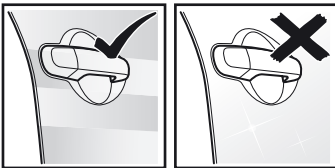

## III. After product 'B'

small drops on all areas

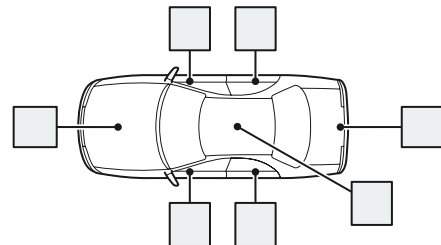
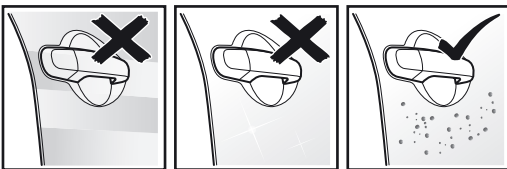

## VI. After wipe

smooth on all areas

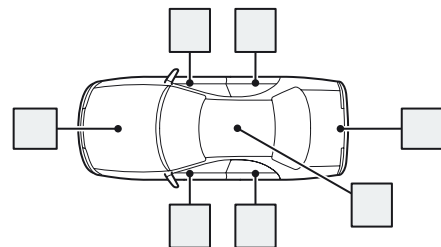

Signature

Stamp