

Corolla Cross

Wind Deflectors - Black

Wind Deflectors - Chrome

Installation Instructions

Model year: As from 2022/08

Vehicle code: Chrome:
ZVG12L-KHXEBW
ZVG12L-KHXGBW
MXGH1**-KHXEHW
MXGH1**-KHXGHW

Black:
ZVG12L-KHXNBW
MXGH1**-KHXNHW

Part number: PC162-0A001 Black
PC162-0A006 Chrome

Manual reference number: AIM 005 216-1

Latest Version
SCAN HERE



Revision Record

Rev. No.	Date	Page	Step	Remarks
△1	31.05.23	All		Updated to new standards

KIT CONTENT

PC162-0A001 - Black / PC162-0A006 - Chrome

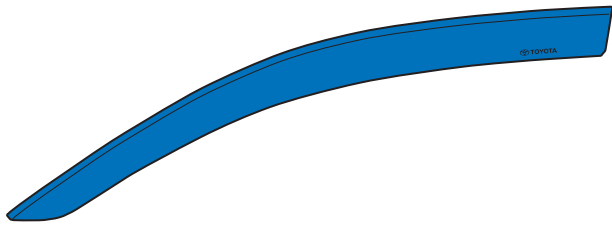

A

1x

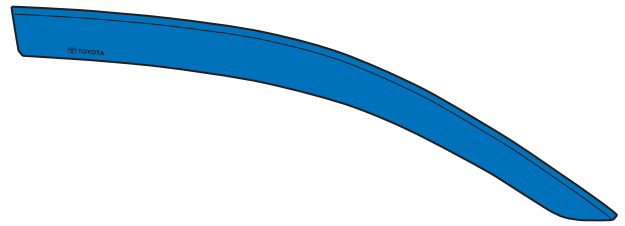

B

1x



C

1x



D

1x

GENERAL

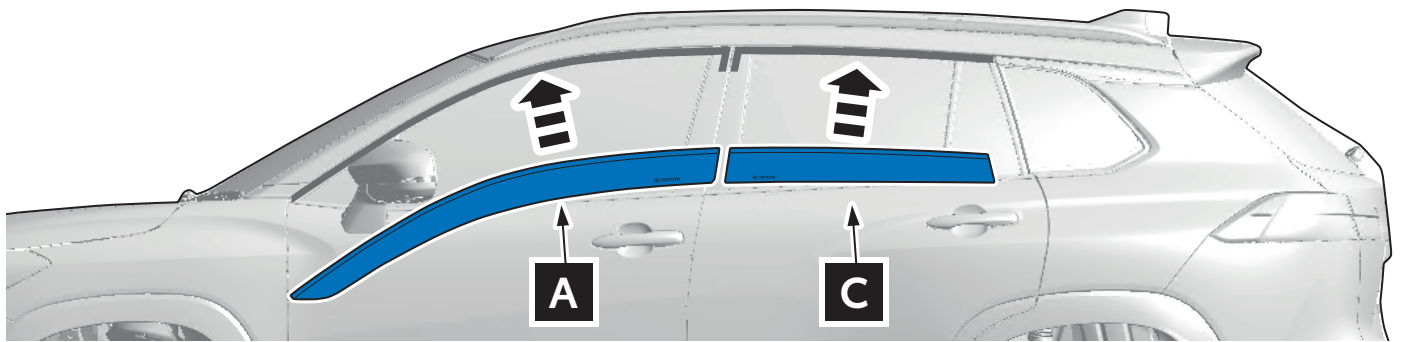

TOOLS

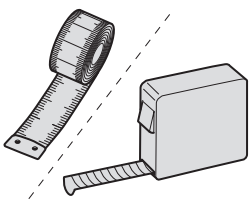

50N

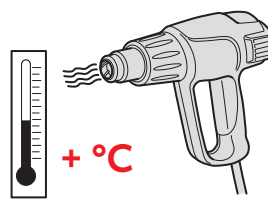
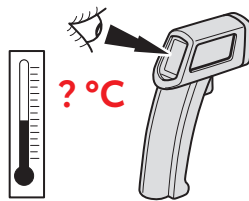
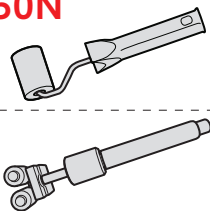

CONSUMABLES

CLEANER / DEGREASER SPRAY

MASKING TAPE



For Symbols
Explanation
SCAN HERE



AIM 003 516-*

GENERAL



Material Safety Data Sheet



Technical Data Sheet

GENERAL



20°C - 40°C



20°C - 40°C

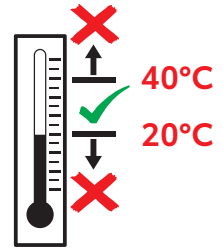
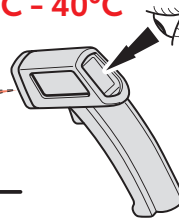

20°C - 40°C

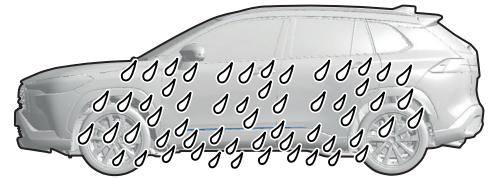
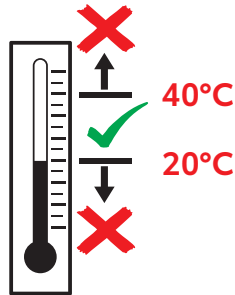
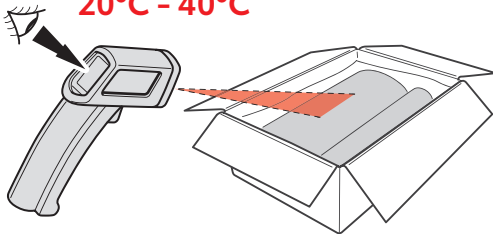

INSTALLATION INSTRUCTIONS

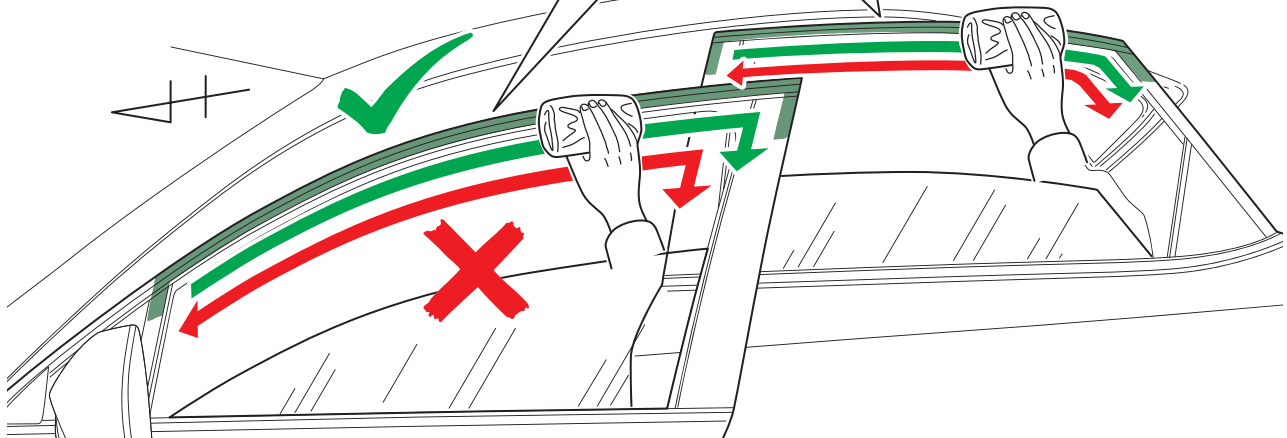
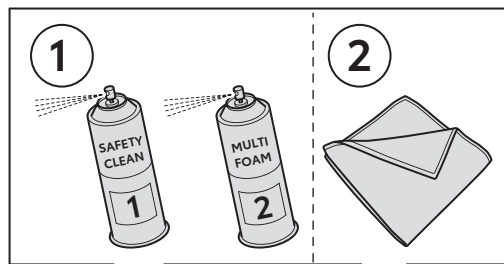

1

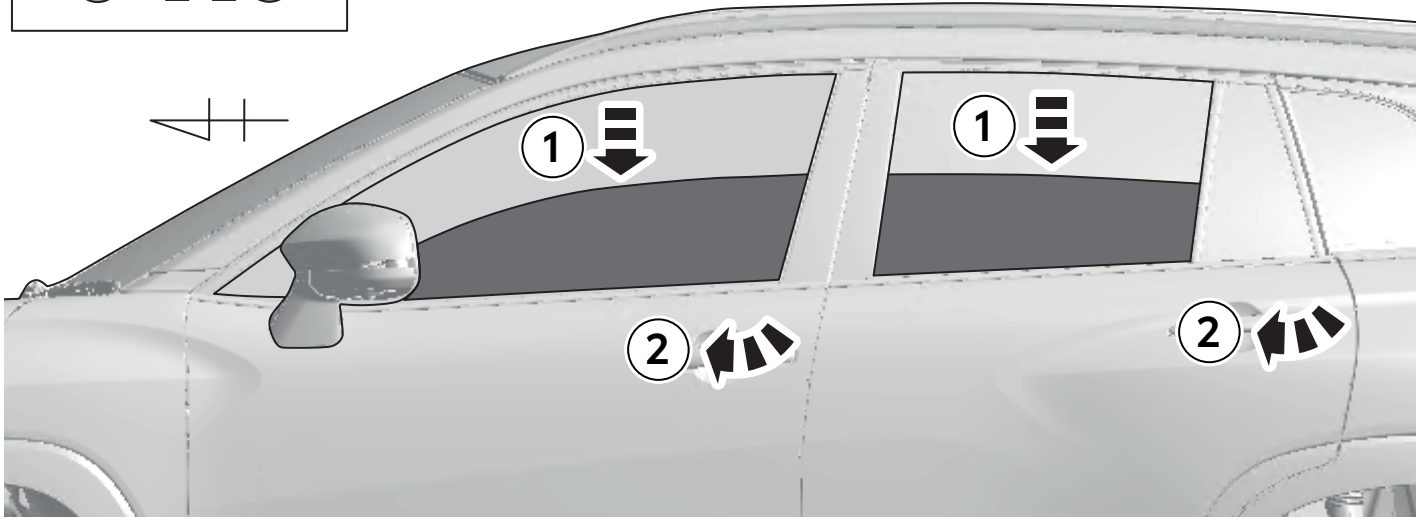
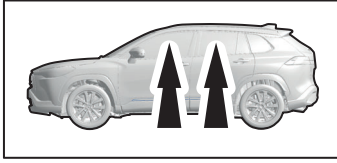

2

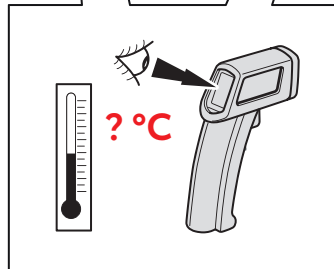
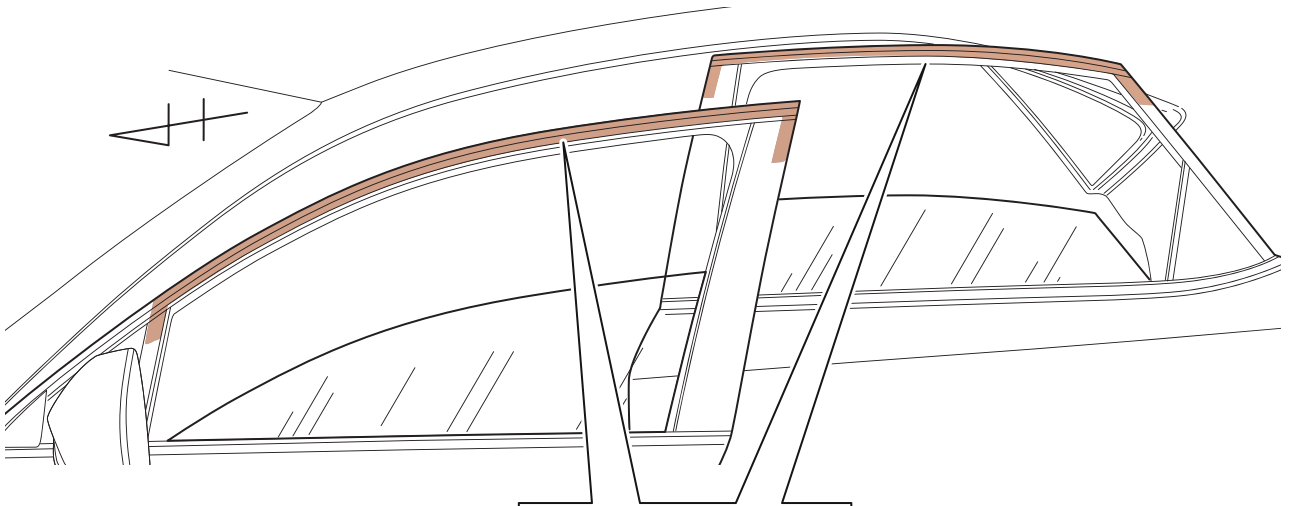

3

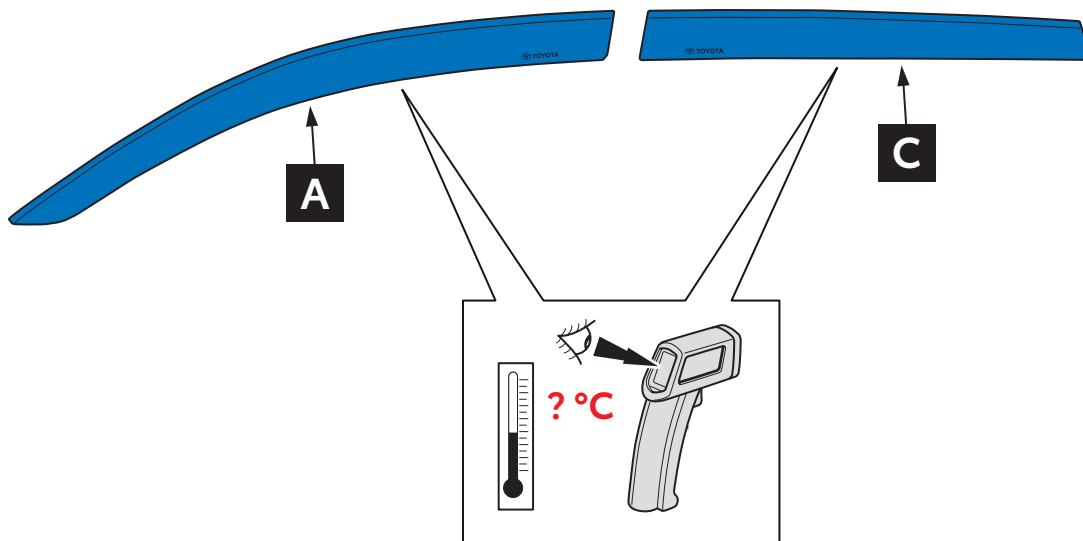

4

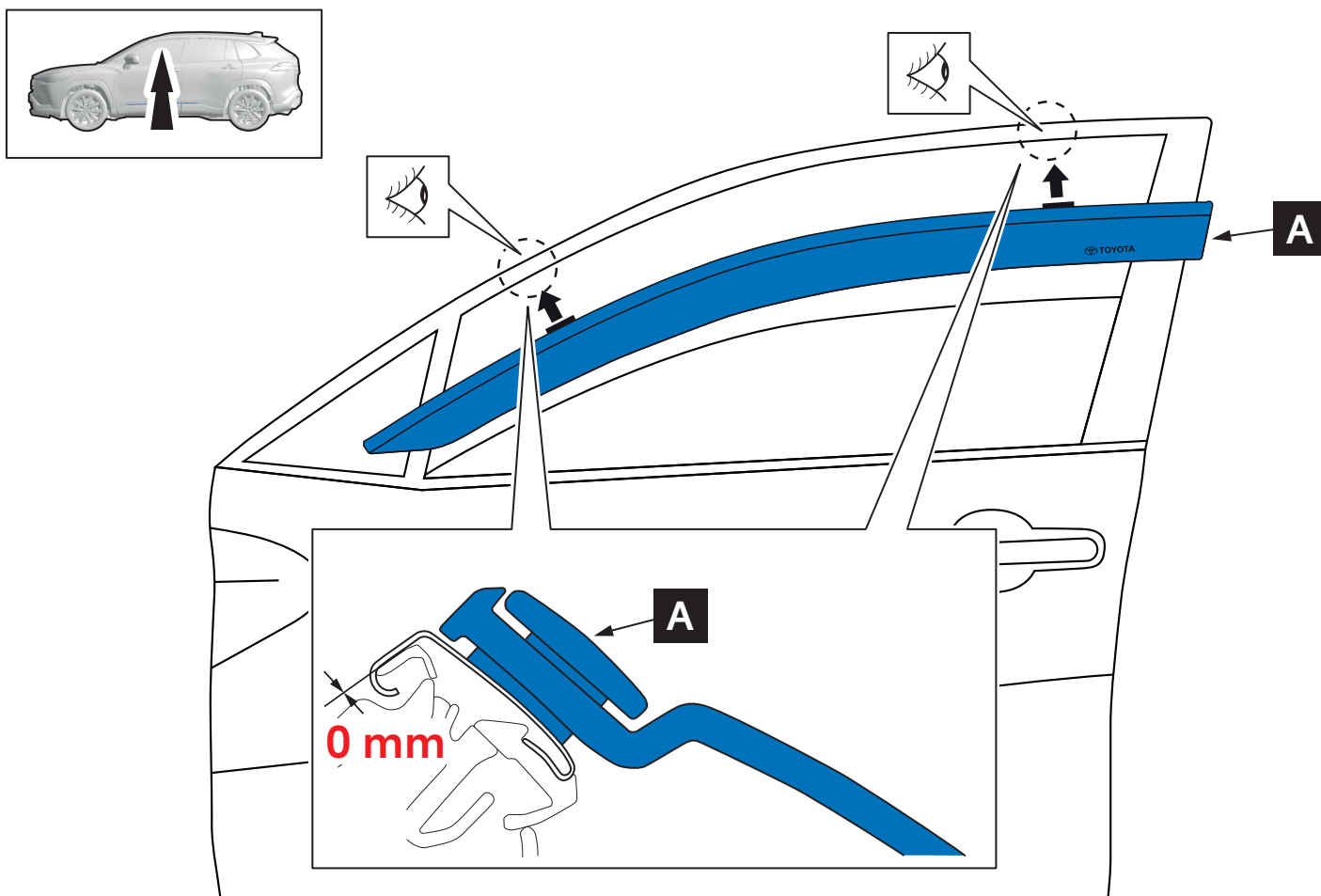

5

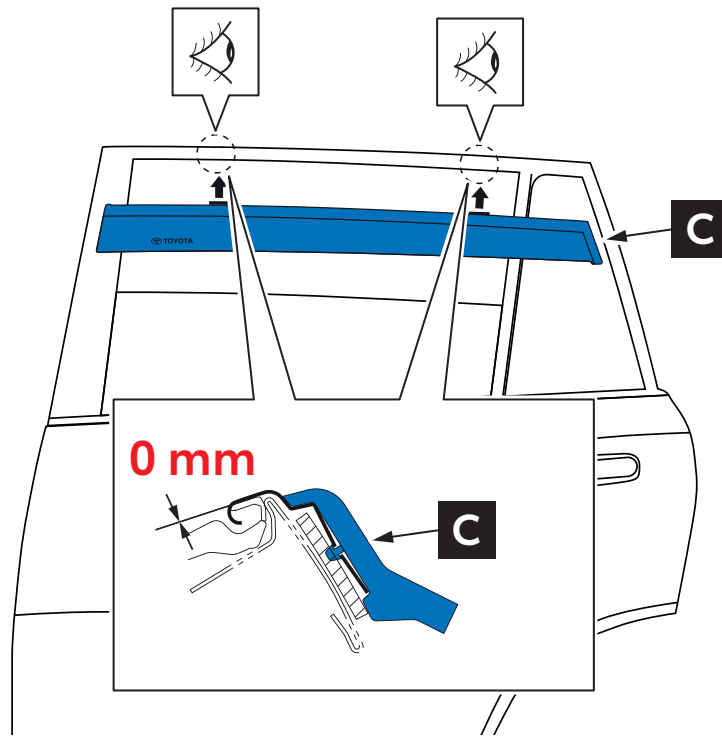
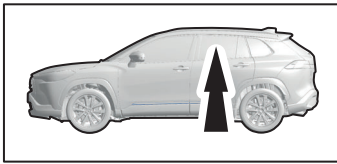

6

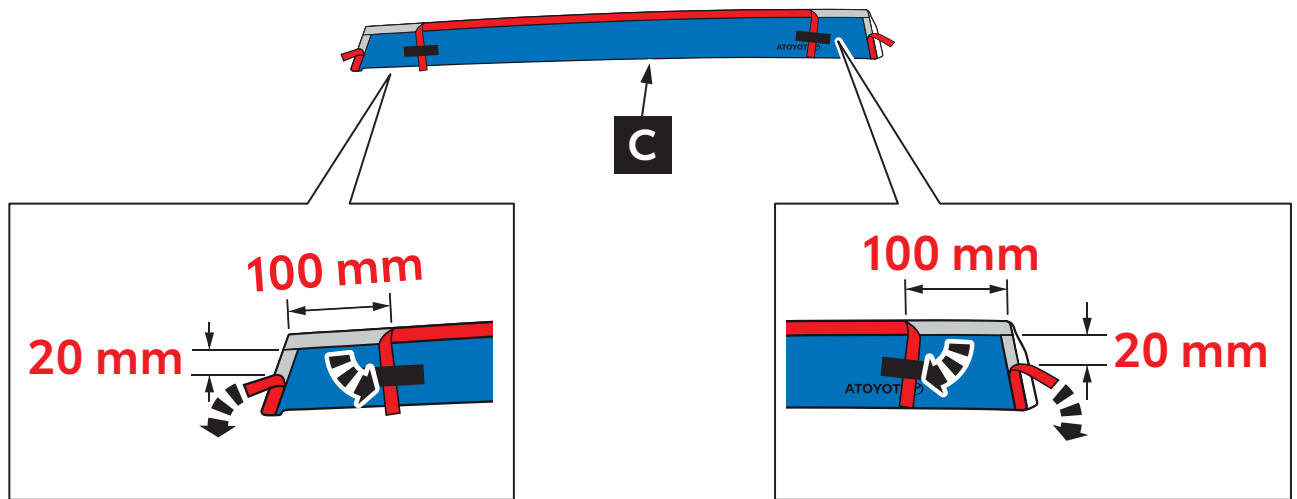
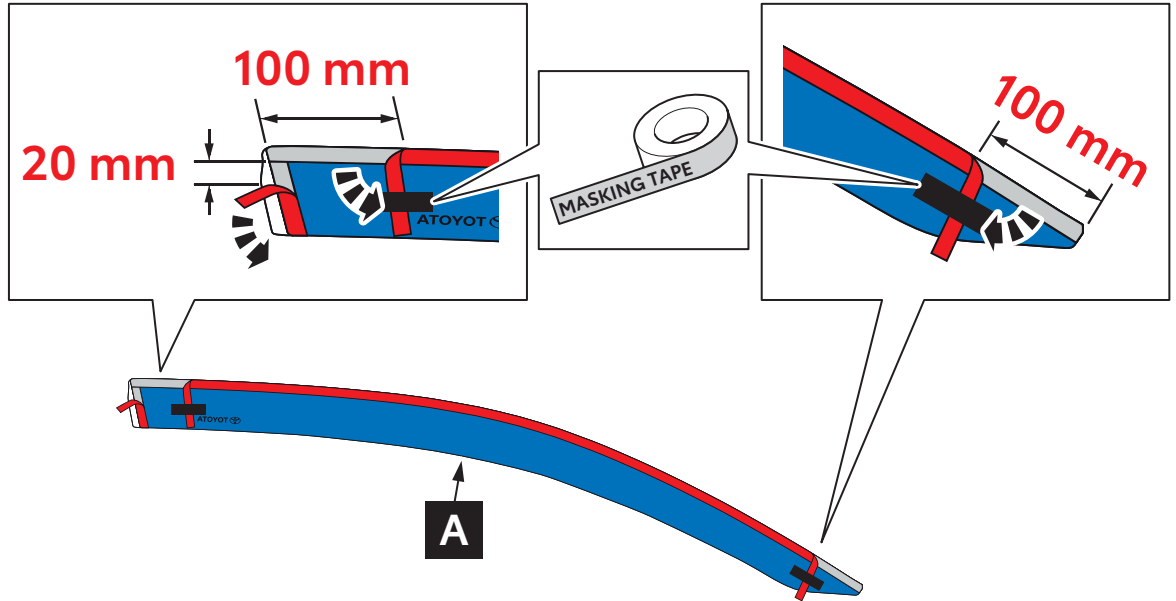
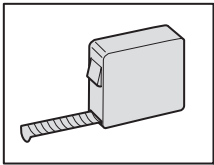

7

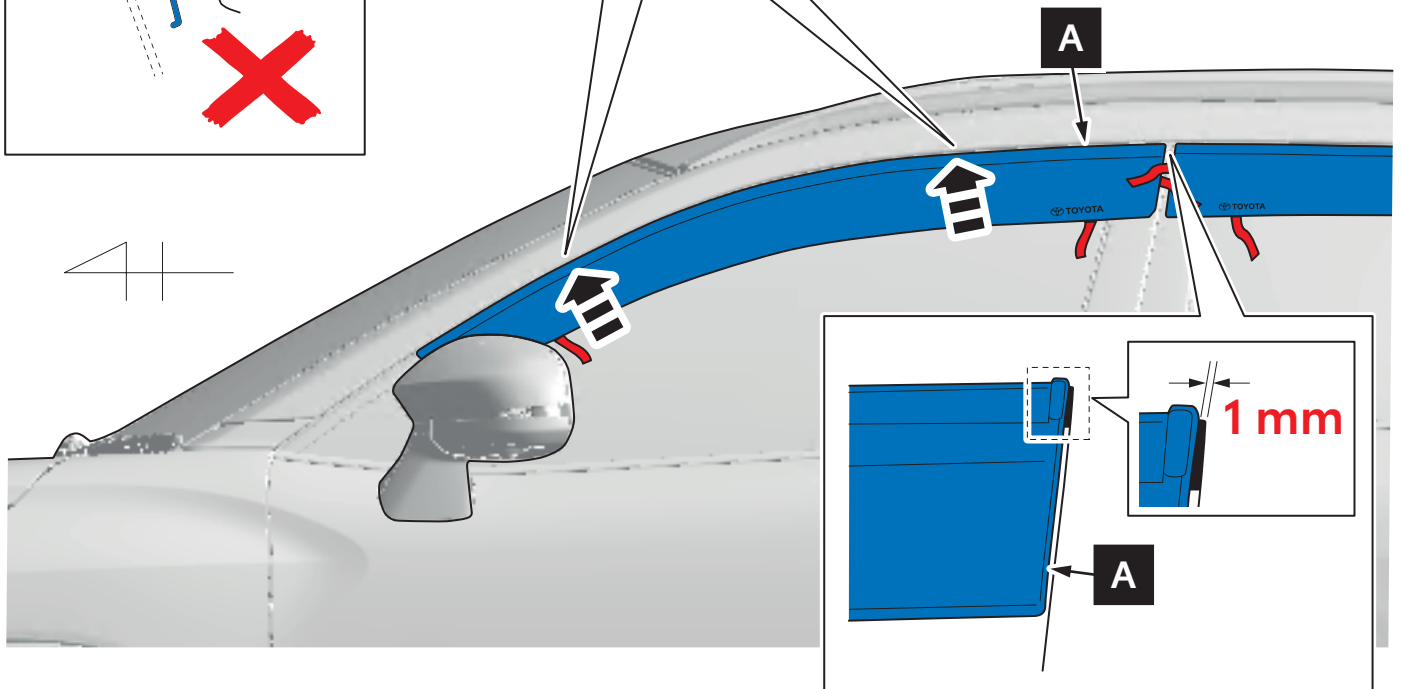
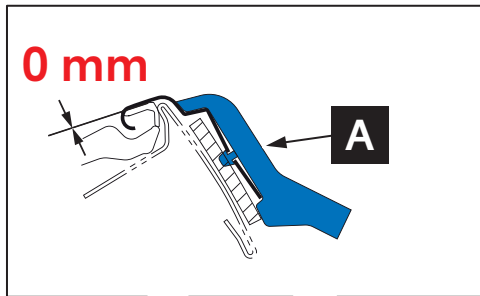
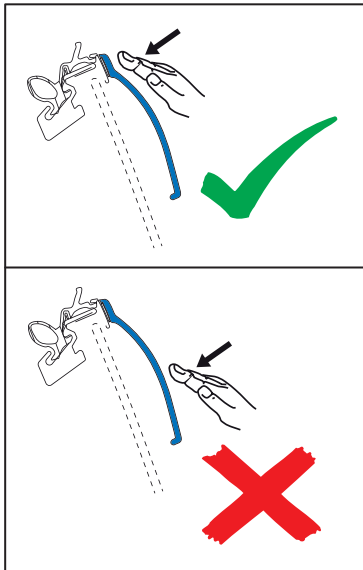
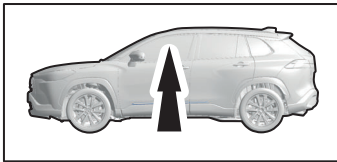

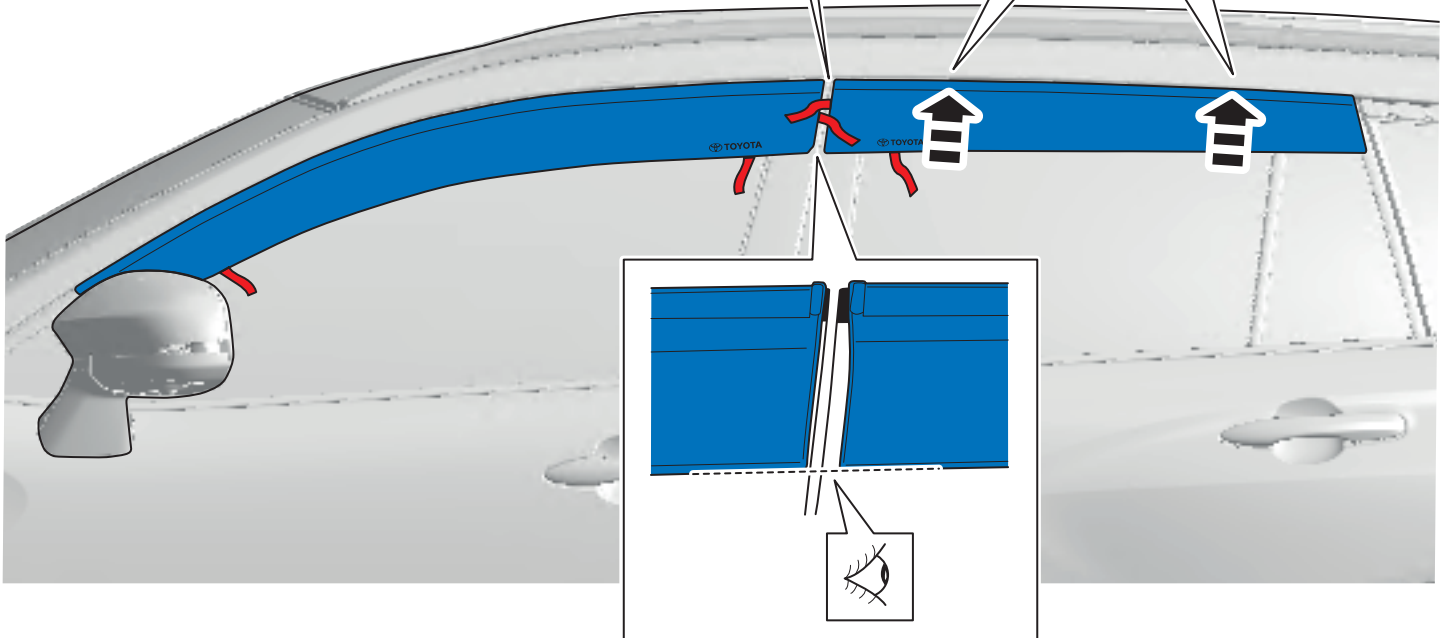
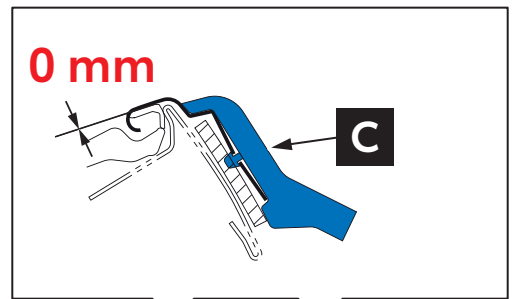
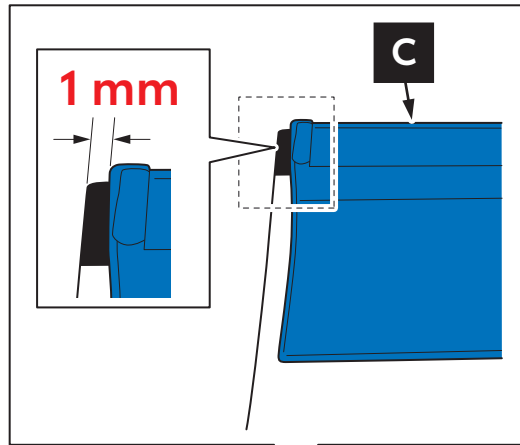
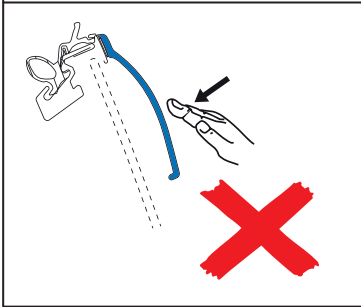
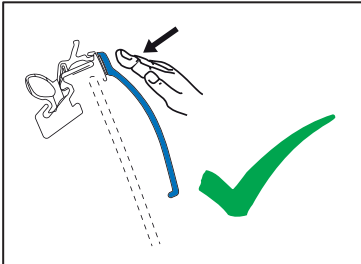
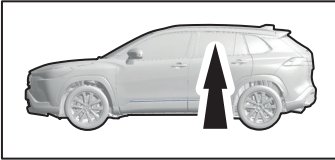

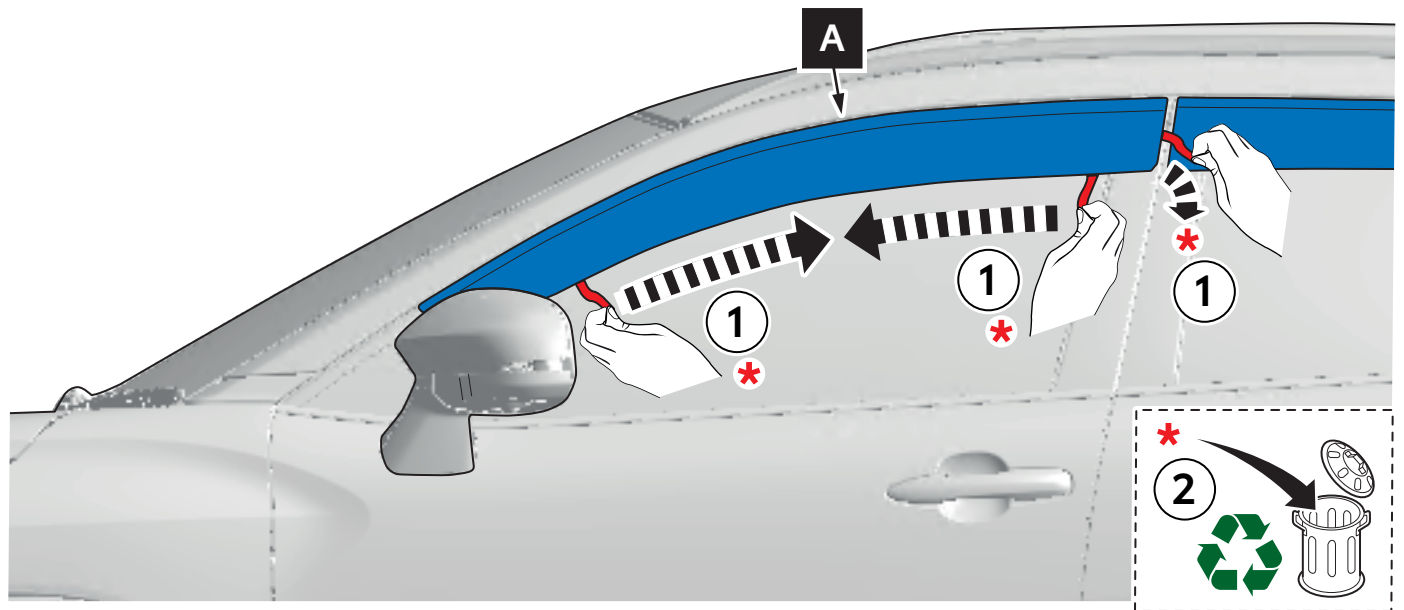
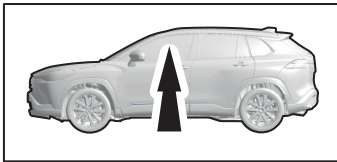

10

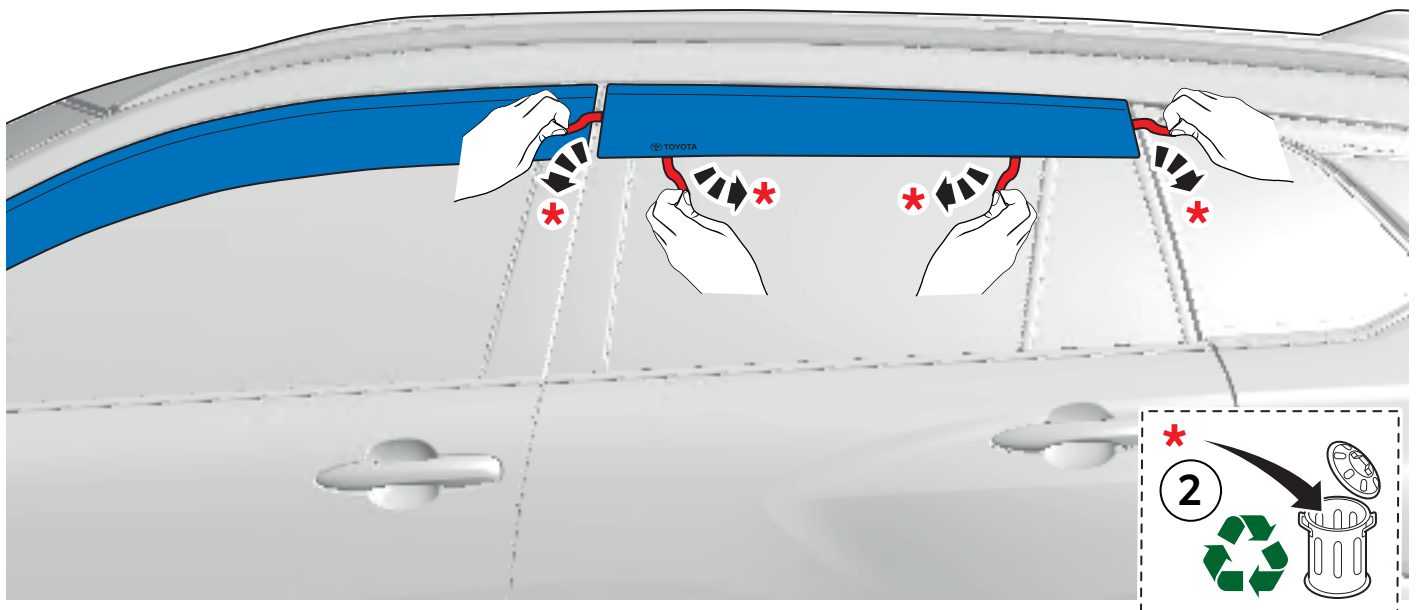
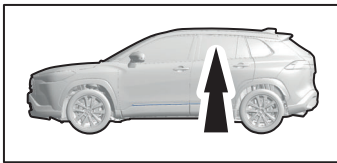

11

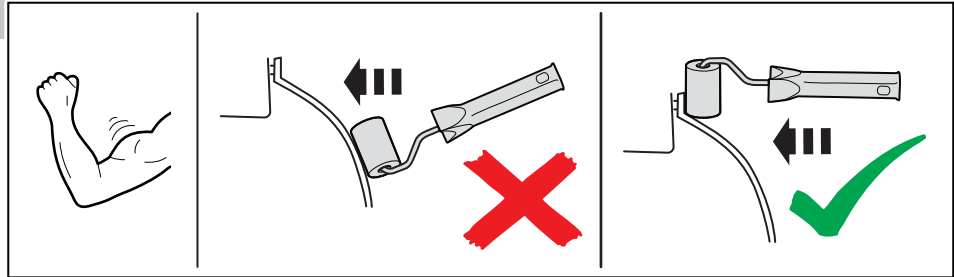
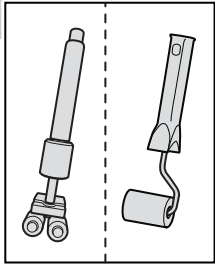
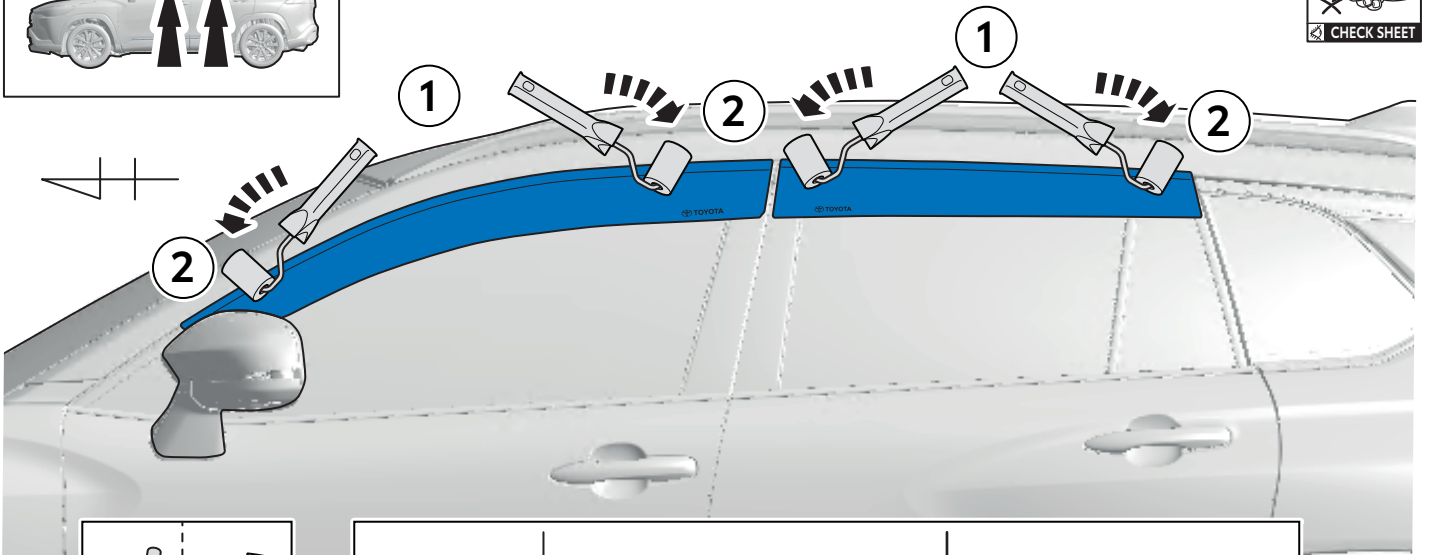
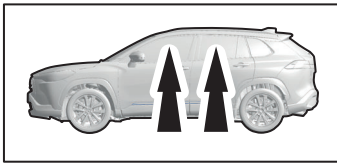

12

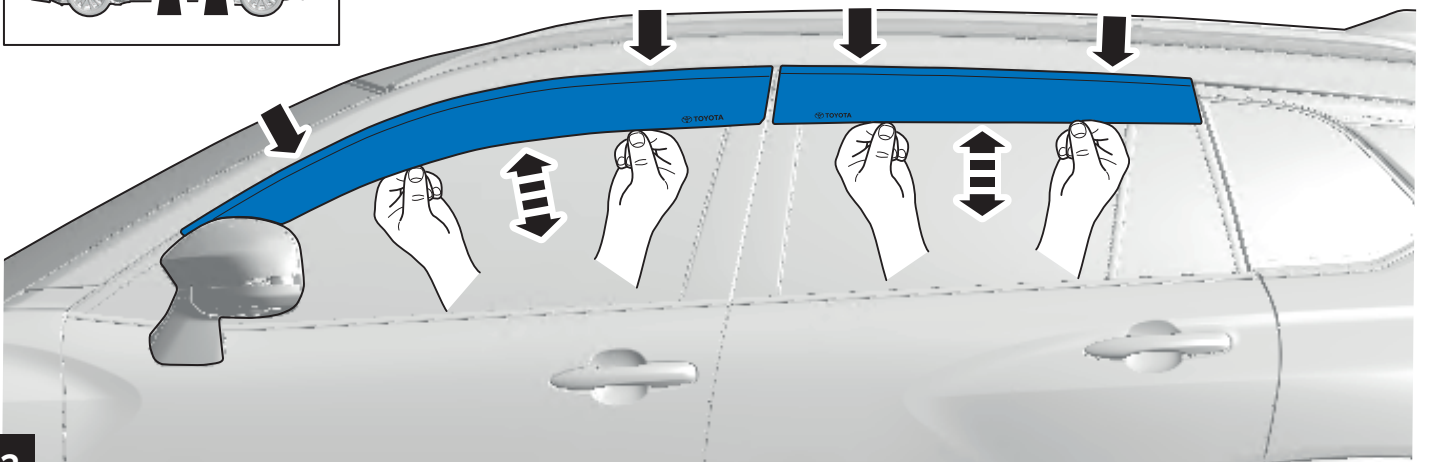
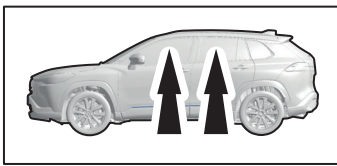

13

Fig.1 → Fig.13

RHS

B D

=

Fig.1 → Fig.13

LHS

A C

14

24 h

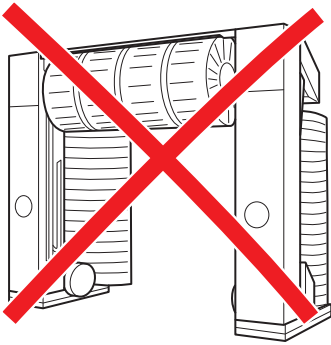

24 h



24 h

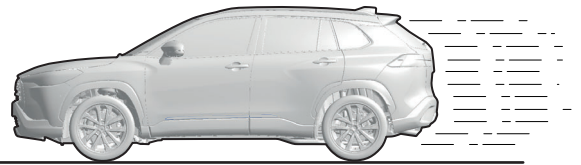
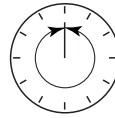

Max. 90 Km/h

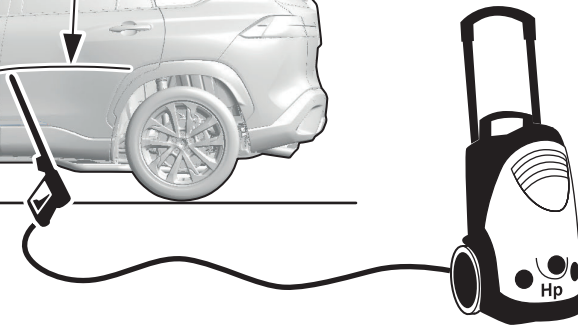
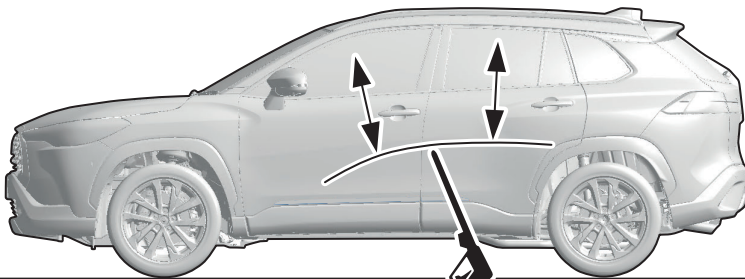

> 0,5 meter

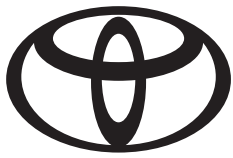

CHECK SHEET

Page 1 of 3

Model/Year Corolla Cross
As from 2022/08

Wind deflectors

VINn°

DURING INSTALLATION

1



= OK

P/N = OK

2

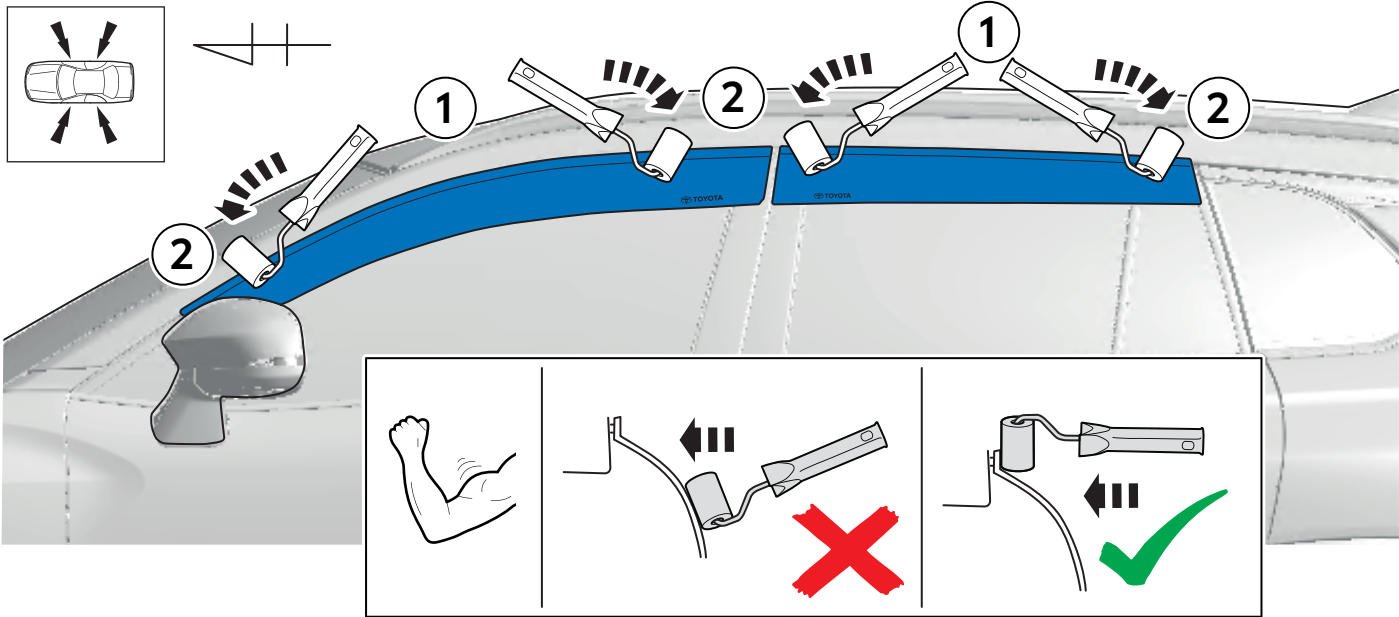

AFTER INSTALLATION

1

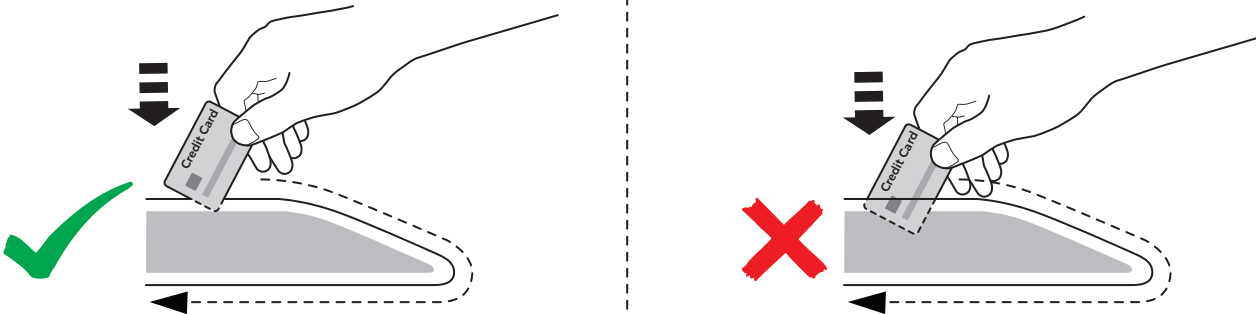

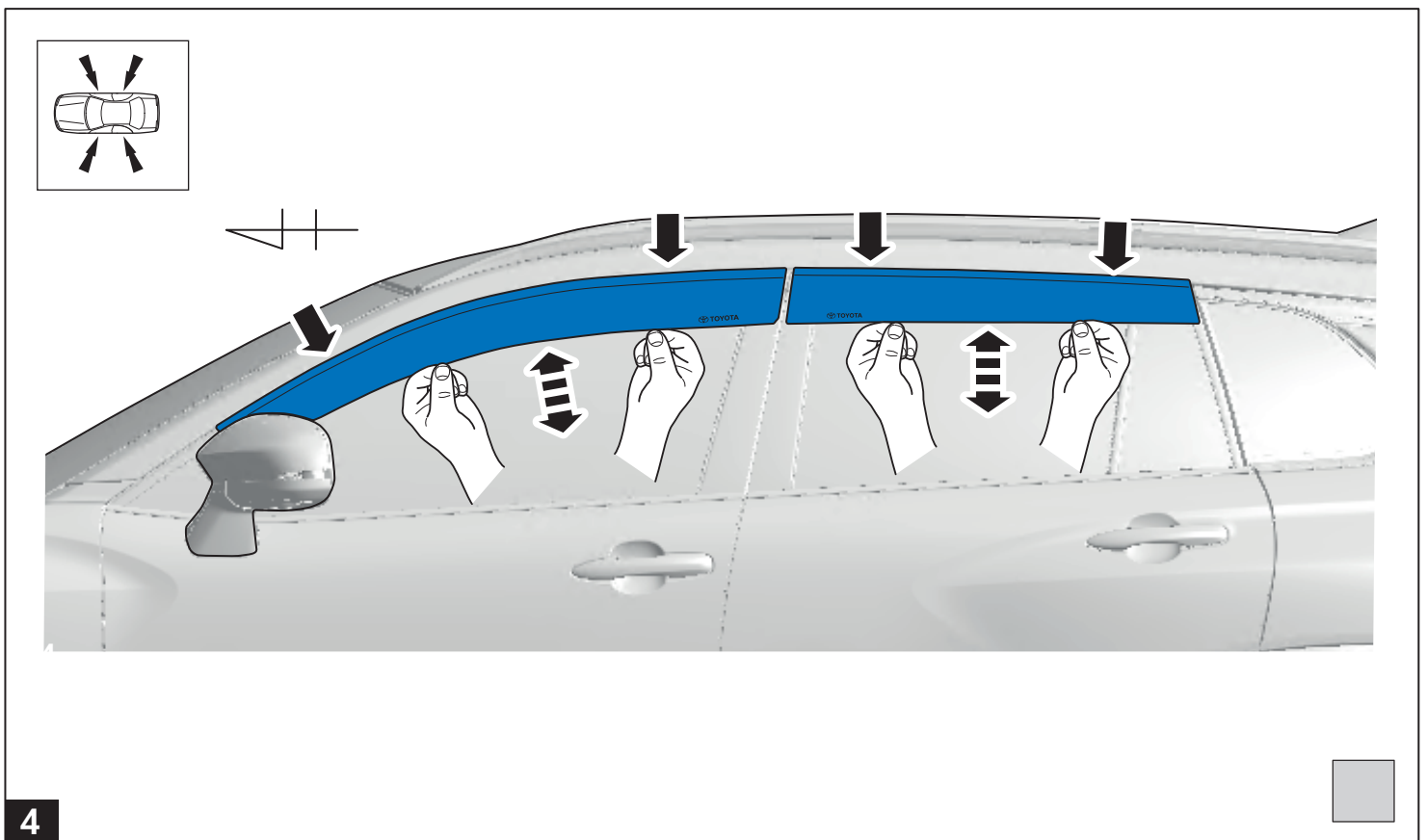
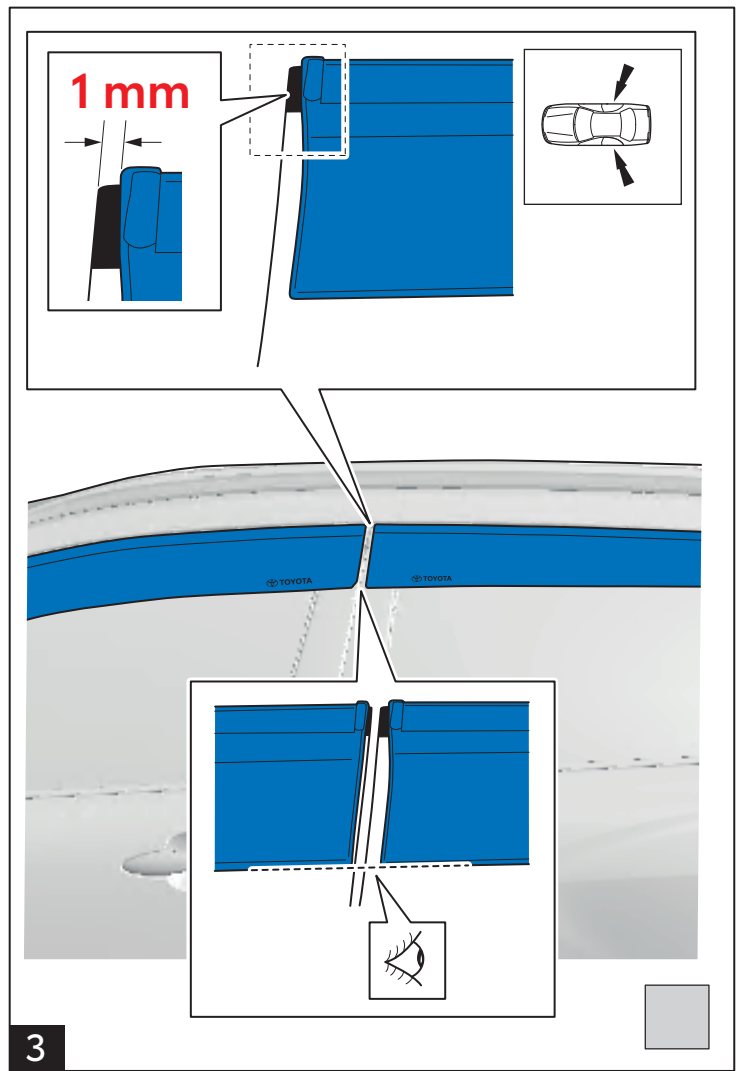
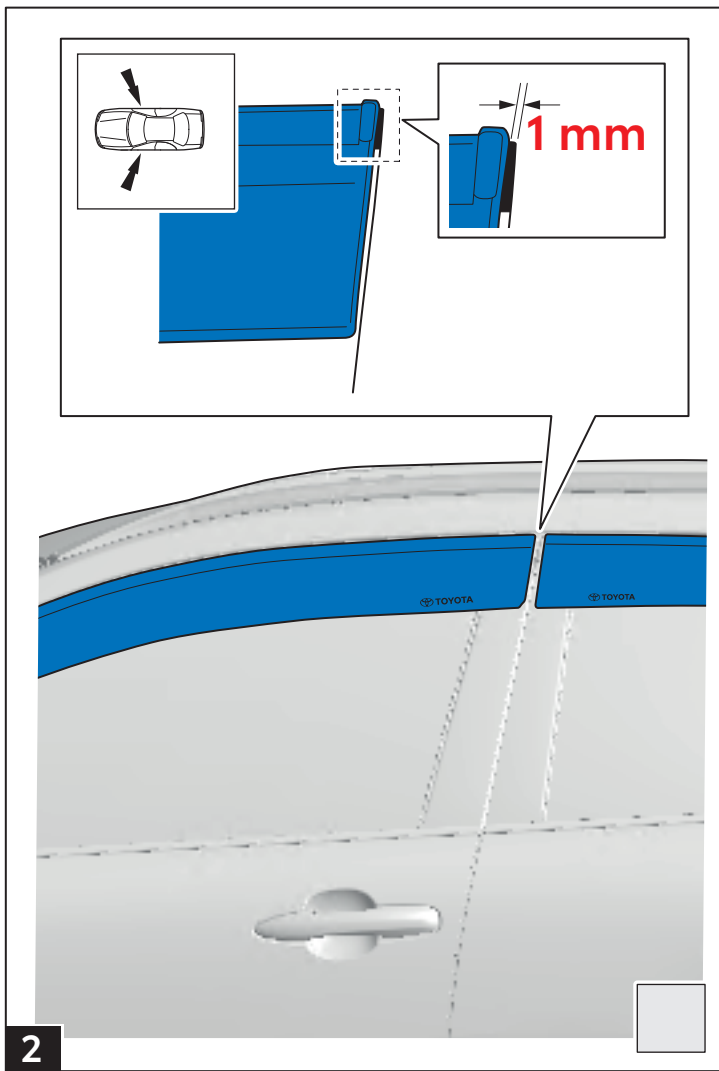

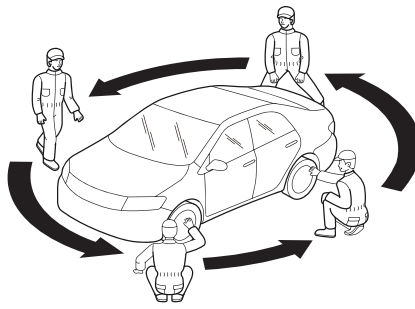
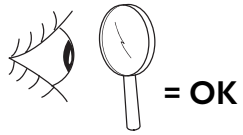

5



Installation Date:

.. / .. /

Technician Name & Signature:

Stamp: