

# Corolla Cross

## Dog Guard & Divider

### Installation Instructions

Model year: As from 2022/07

Vehicle code: ZVG12L-KHX\*BW  
MXGH1\*\*-KHX\*HW

Part number: PW255-16000 Dog Guard  
PW255-16001 Divider

Latest Version  
SCAN HERE



Manual reference number: AIM 006 221-1

# Revision Record

| Rev. No.       | Date       | Page | Step | Remarks                     |
|----------------|------------|------|------|-----------------------------|
| △ <sub>1</sub> | 05.05.2023 |      |      | Updated to latest Standards |
|                |            |      |      |                             |
|                |            |      |      |                             |
|                |            |      |      |                             |
|                |            |      |      |                             |
|                |            |      |      |                             |
|                |            |      |      |                             |
|                |            |      |      |                             |
|                |            |      |      |                             |
|                |            |      |      |                             |
|                |            |      |      |                             |
|                |            |      |      |                             |
|                |            |      |      |                             |
|                |            |      |      |                             |
|                |            |      |      |                             |
|                |            |      |      |                             |
|                |            |      |      |                             |
|                |            |      |      |                             |
|                |            |      |      |                             |
|                |            |      |      |                             |
|                |            |      |      |                             |
|                |            |      |      |                             |
|                |            |      |      |                             |
|                |            |      |      |                             |
|                |            |      |      |                             |
|                |            |      |      |                             |
|                |            |      |      |                             |
|                |            |      |      |                             |
|                |            |      |      |                             |
|                |            |      |      |                             |
|                |            |      |      |                             |
|                |            |      |      |                             |
|                |            |      |      |                             |
|                |            |      |      |                             |
|                |            |      |      |                             |
|                |            |      |      |                             |
|                |            |      |      |                             |
|                |            |      |      |                             |
|                |            |      |      |                             |
|                |            |      |      |                             |
|                |            |      |      |                             |
|                |            |      |      |                             |
|                |            |      |      |                             |
|                |            |      |      |                             |
|                |            |      |      |                             |
|                |            |      |      |                             |
|                |            |      |      |                             |

**KIT CONTENT**

**PW255-16000**

**Dog Guard**

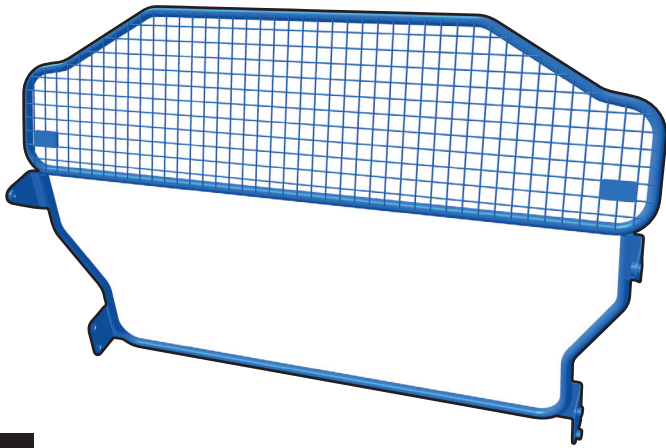

**A** x1

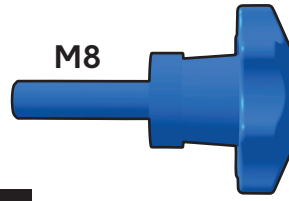

**D** x2



**E** x2

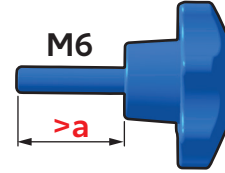

**F** x2

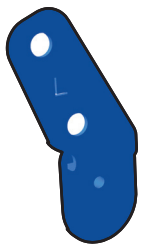

**B** LHS x1



**C** RHS x1

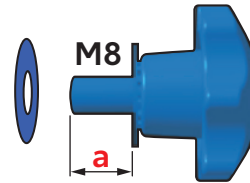

**G** x4

**PW255-16001**

**Divider**

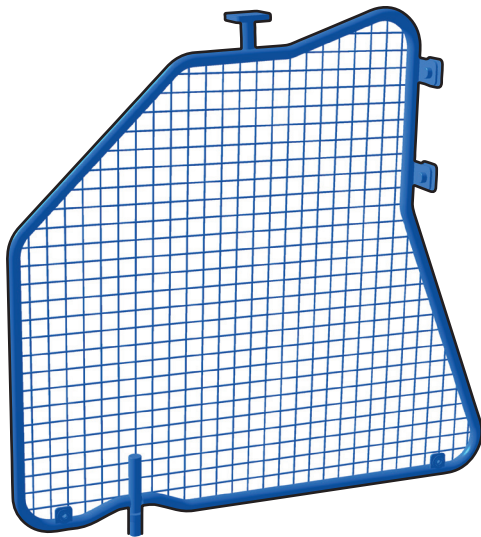

**H** x1



**I** x2

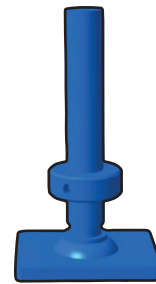

**J** x1



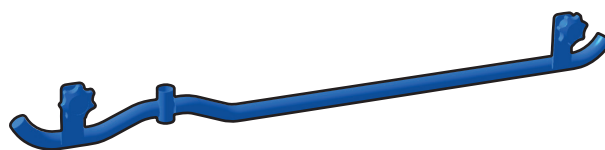

**K** x1

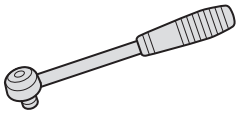
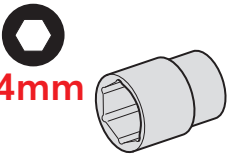

**L** x1

# TOOLS

| RATCHET  | HEXAGONAL SOCKET   |  |  | For Symbols Explanation<br>SCAN HERE  |
|--|--|--|--|---|
|  | <br><b>14mm</b> |  |  |  |

# GENERAL



|  |   |  |
|--|---|--|
| <br><br> | <br><br><b>Material Safety Data Sheet</b> | <br><br><b>Technical Data Sheet</b> |
|--|---|--|

# INSTALLATION INSTRUCTIONS



1

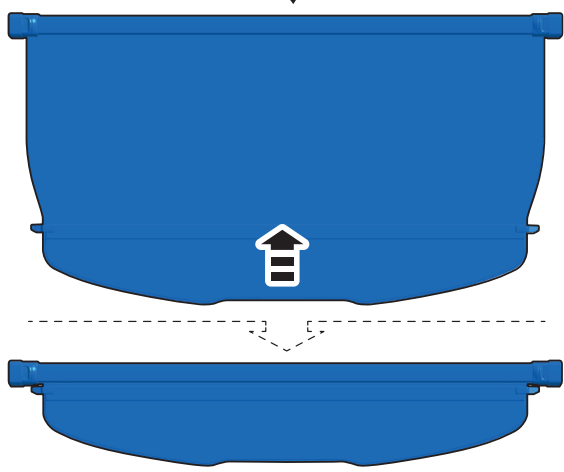
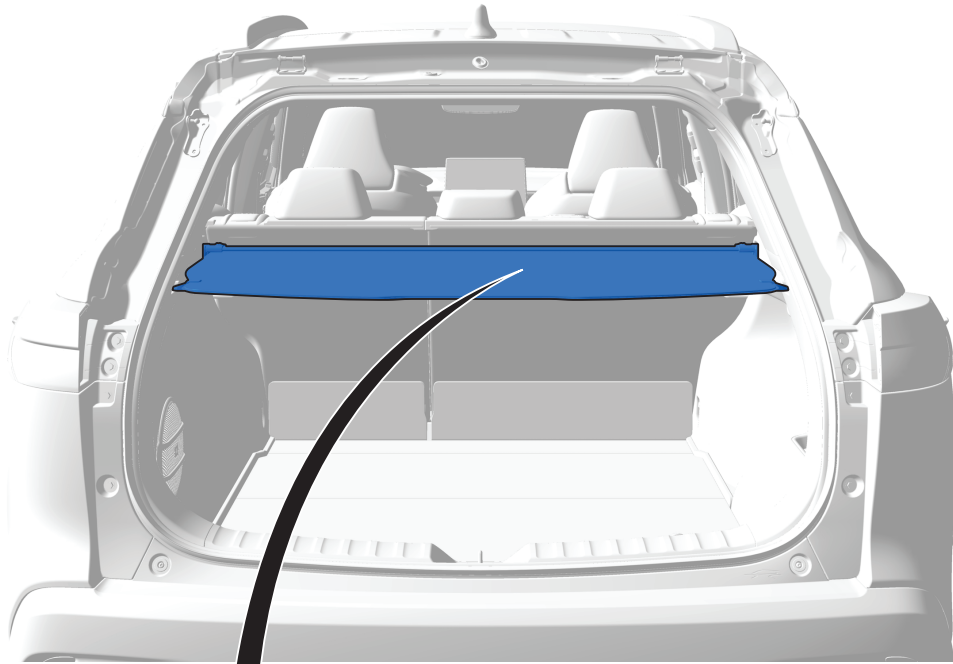

2

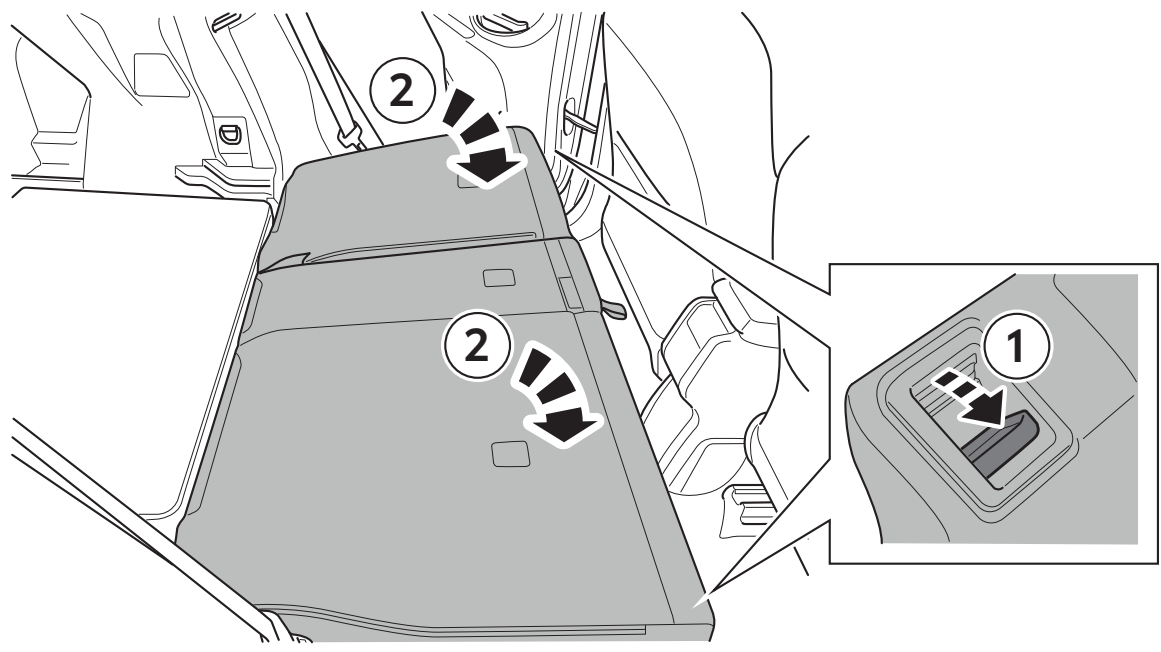

3

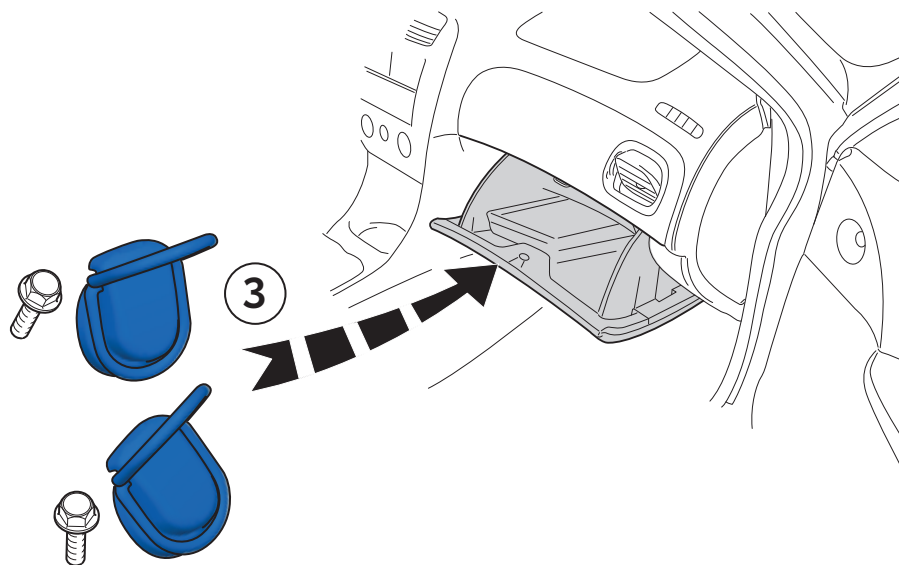
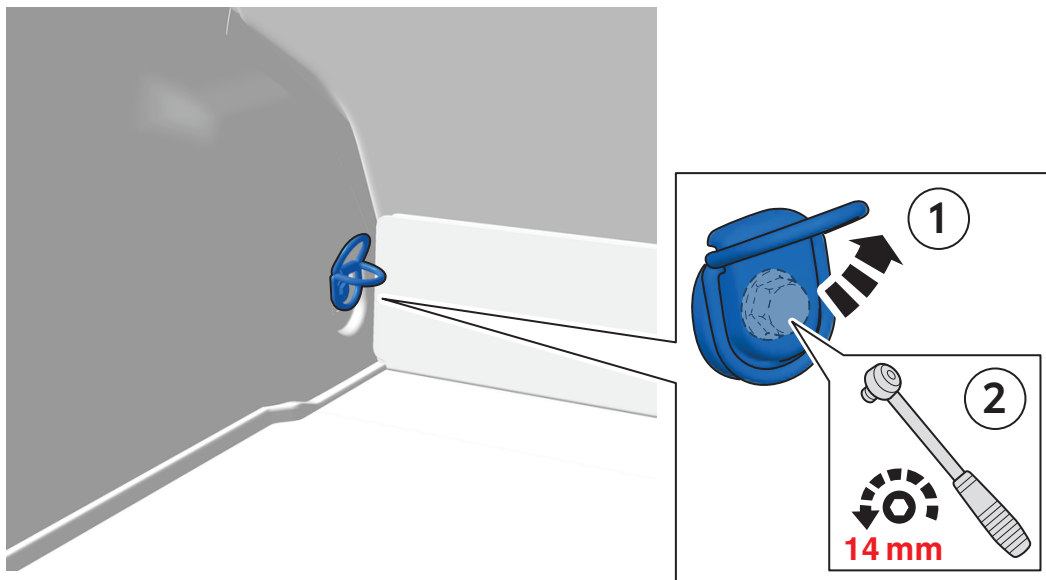
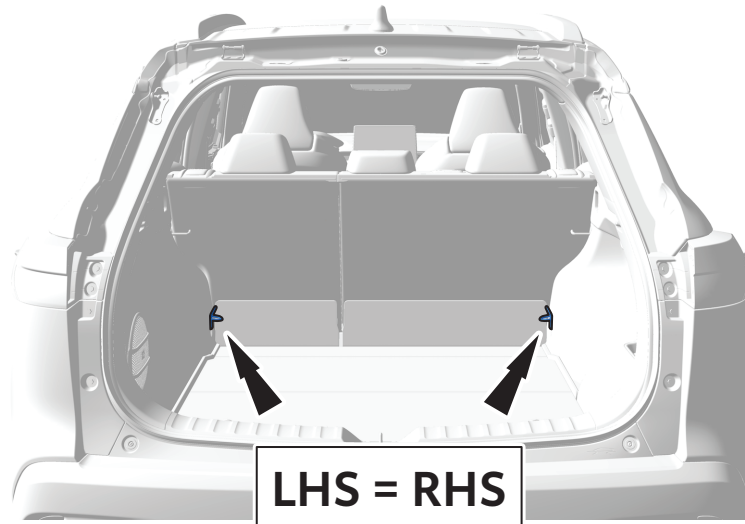

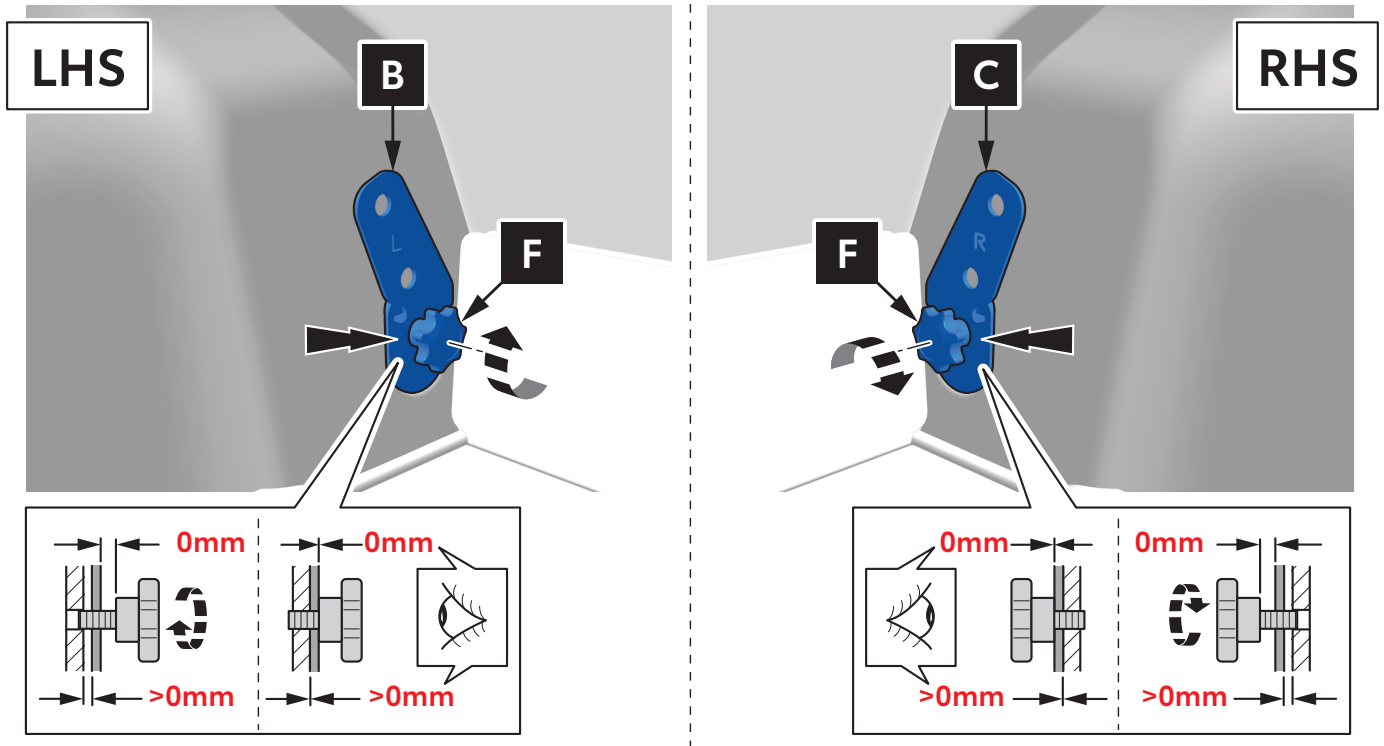
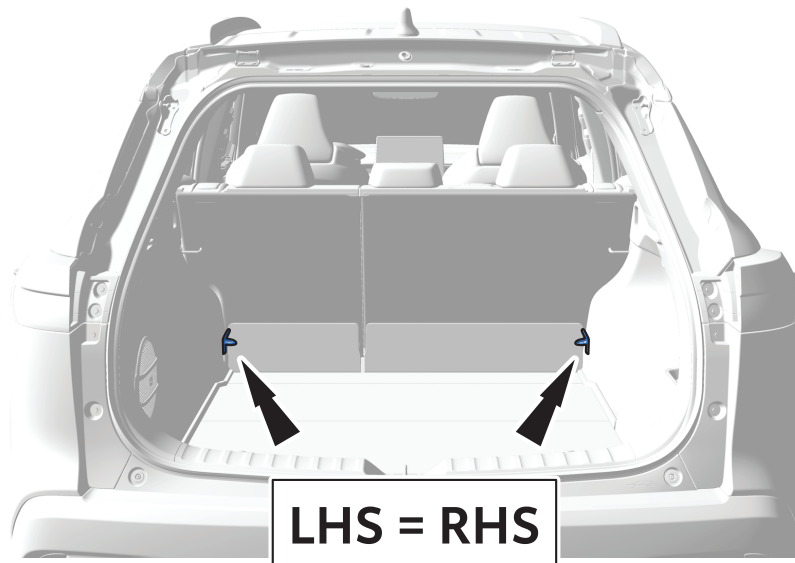

LHS = RHS

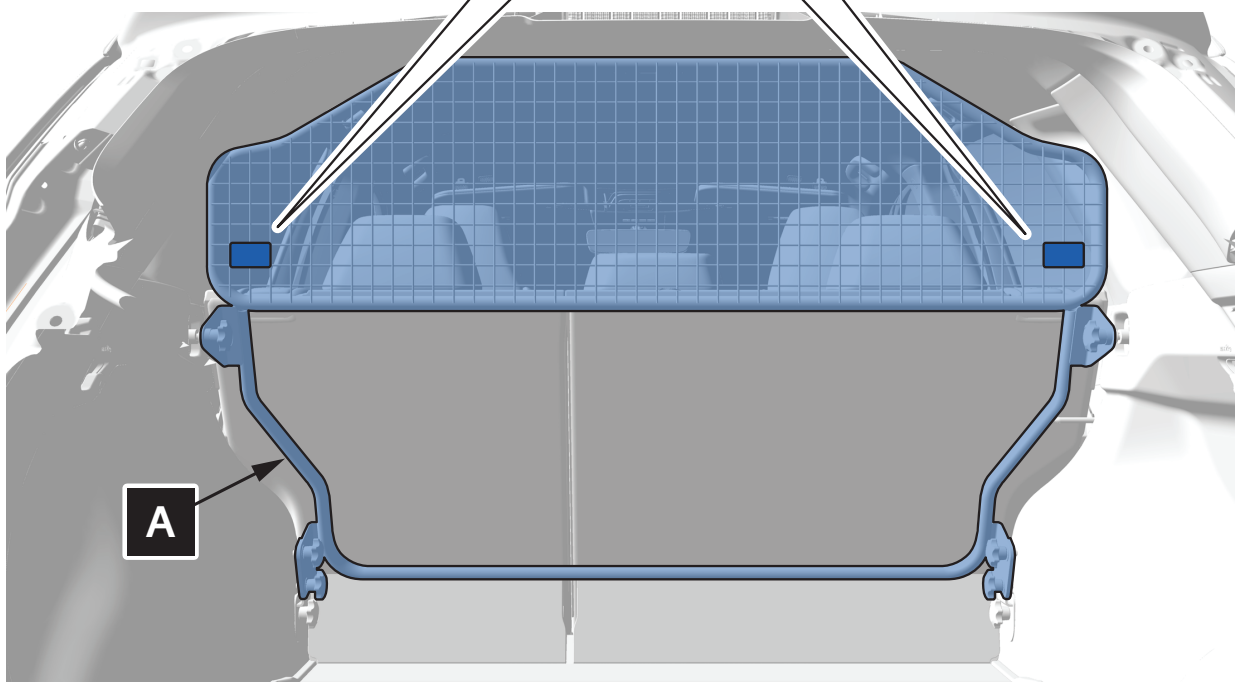
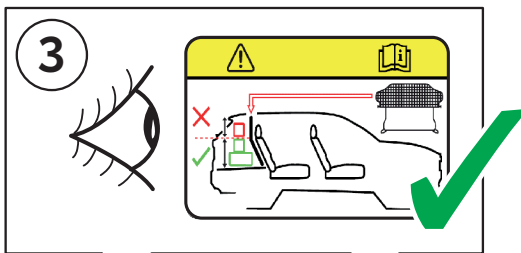
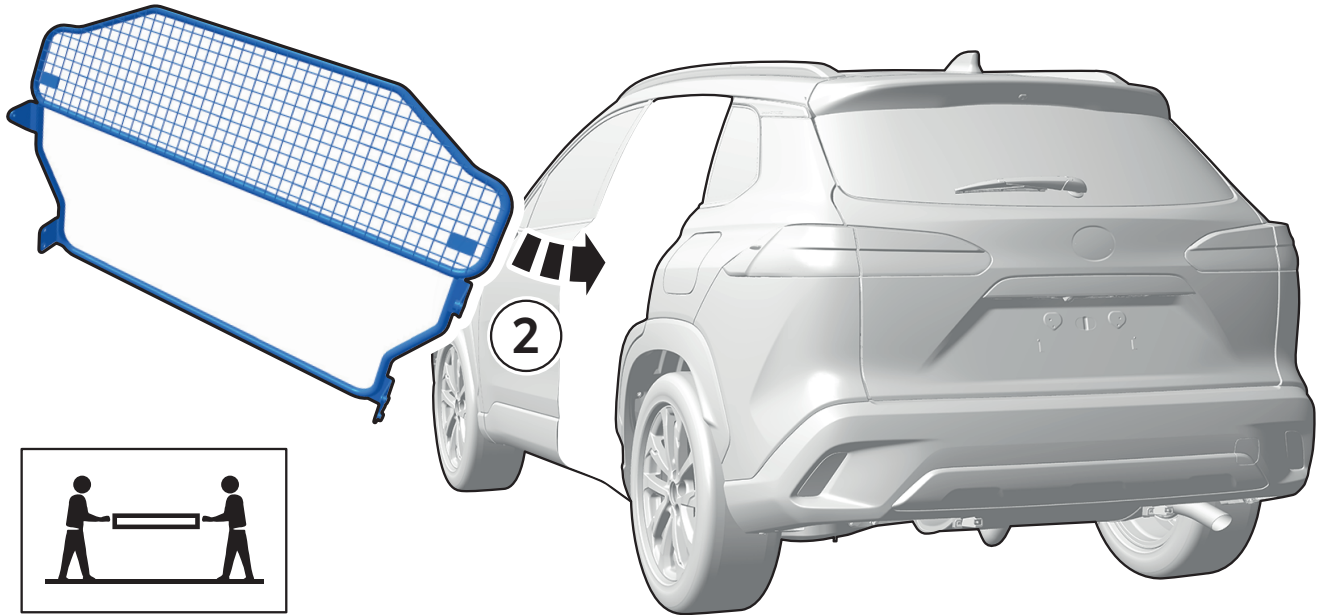
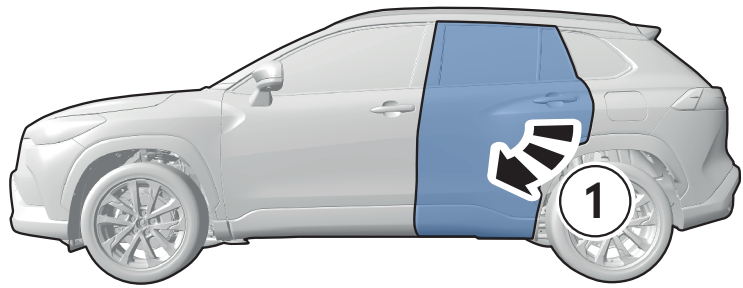



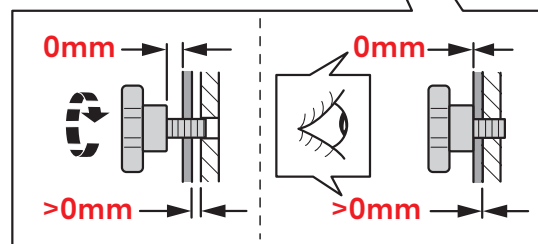
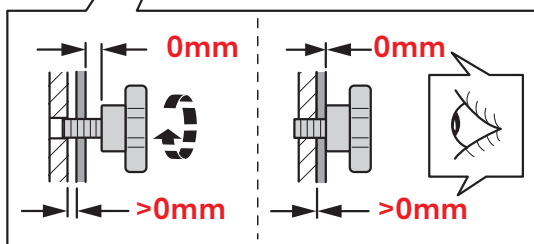
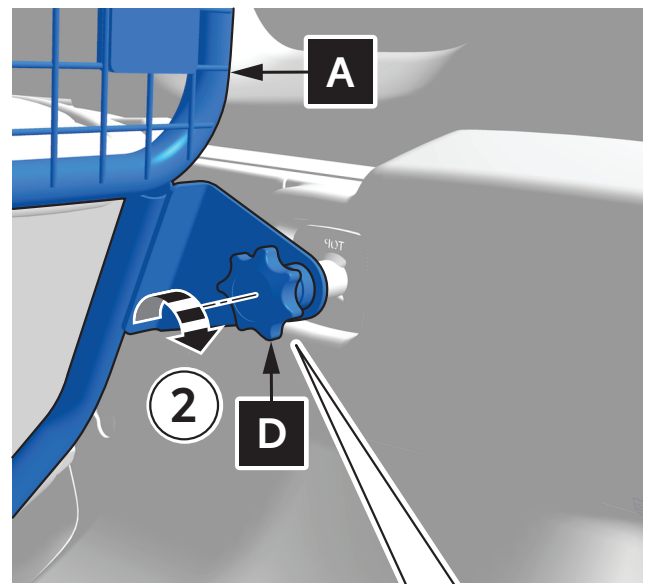
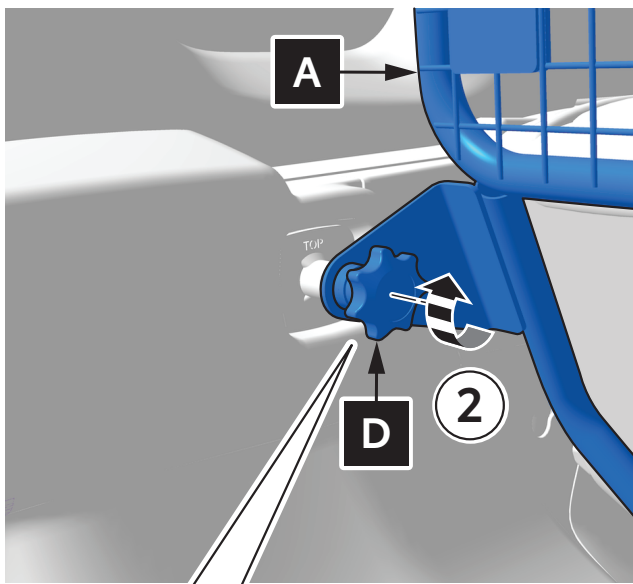
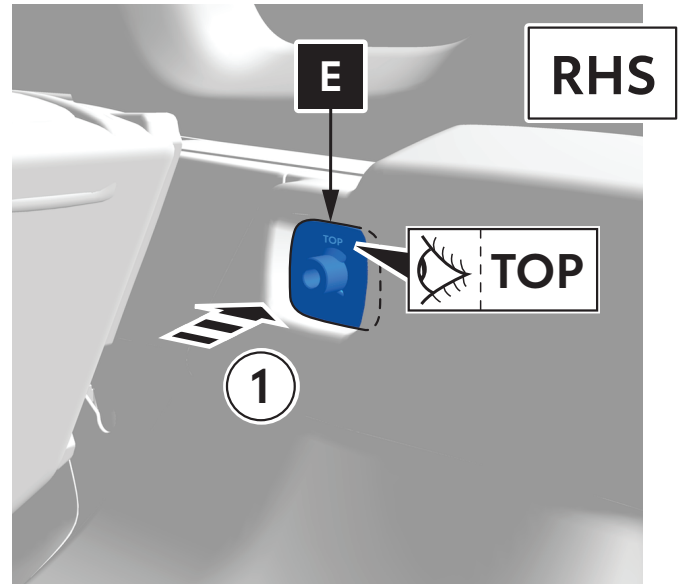
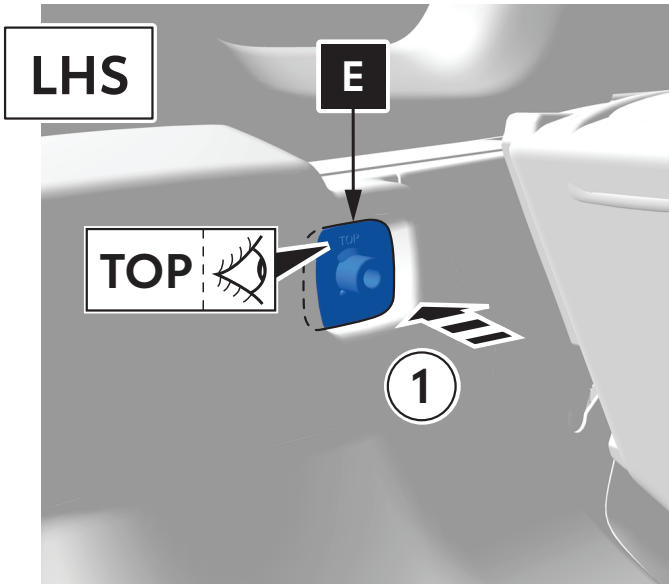
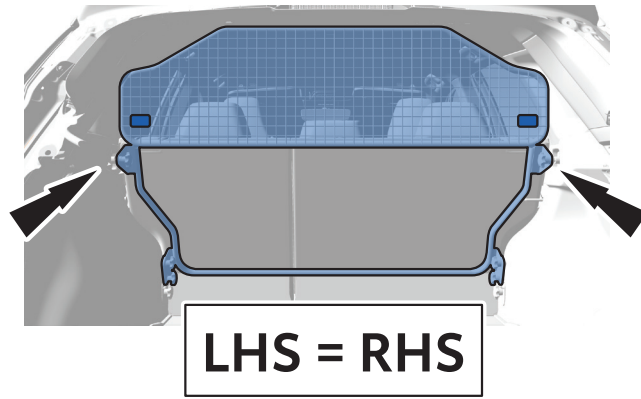

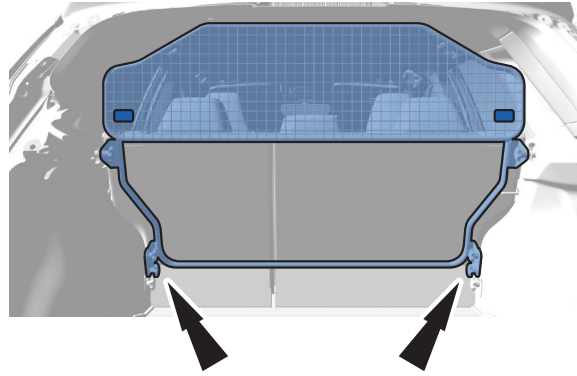

**LHS = RHS**

**LHS**

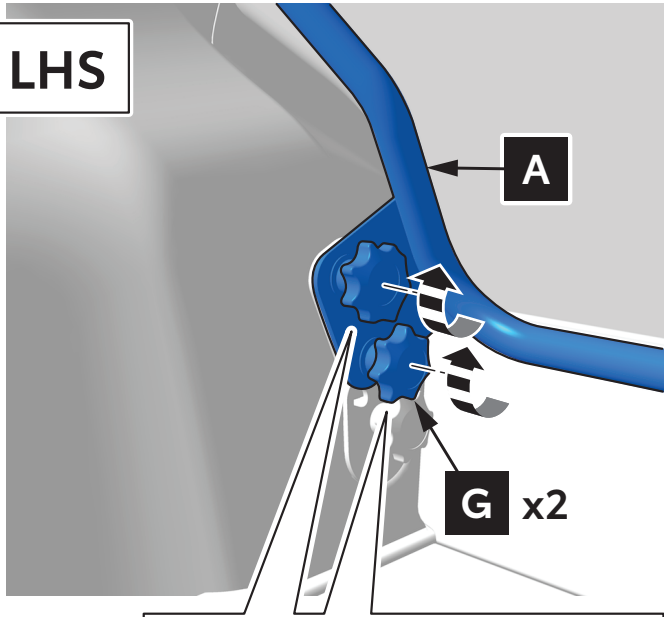

**RHS**

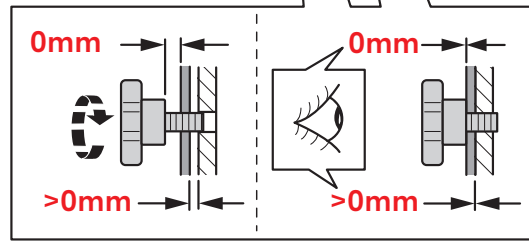
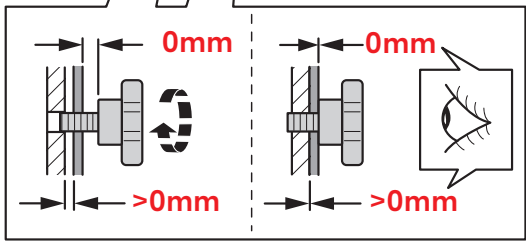
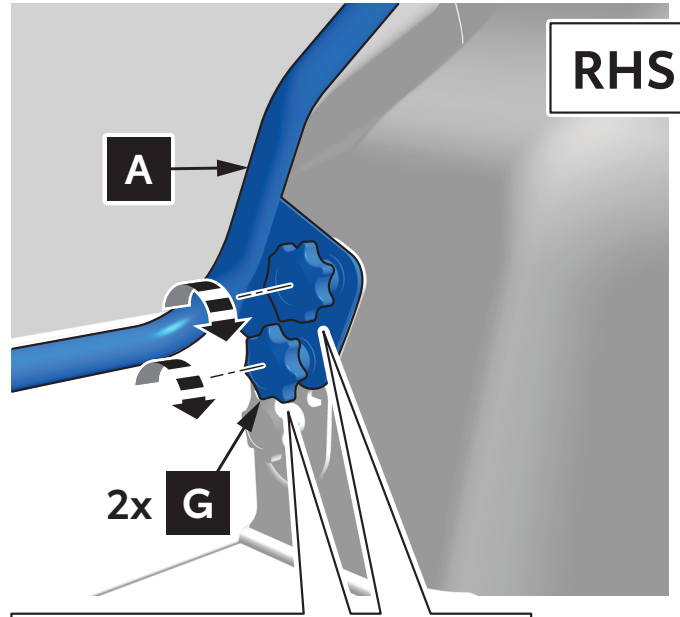



LHS = RHS

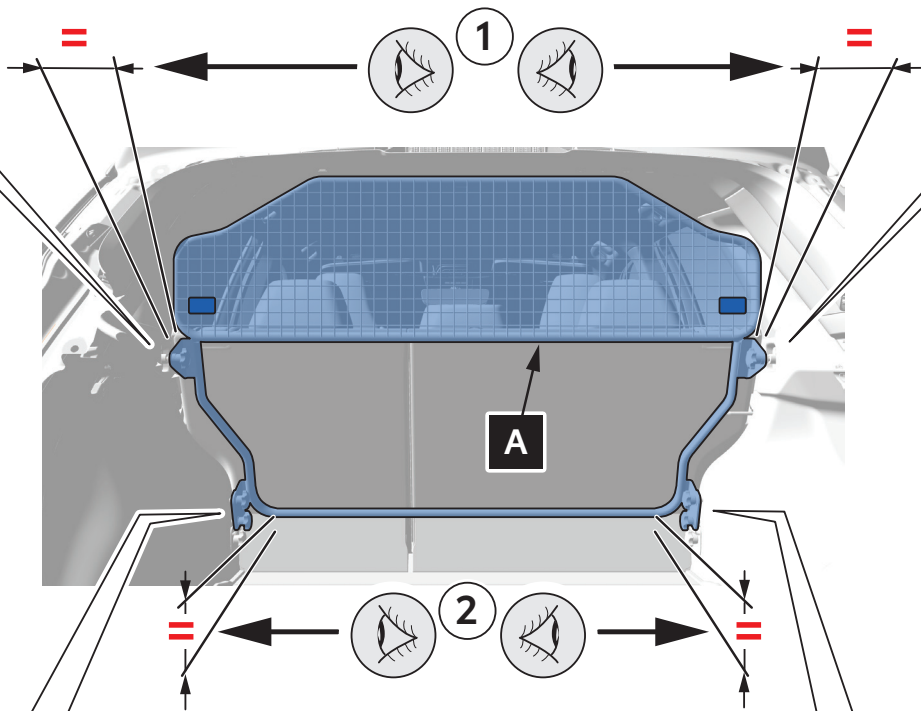
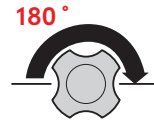
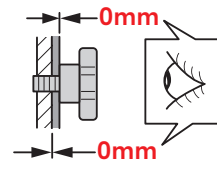
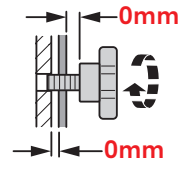
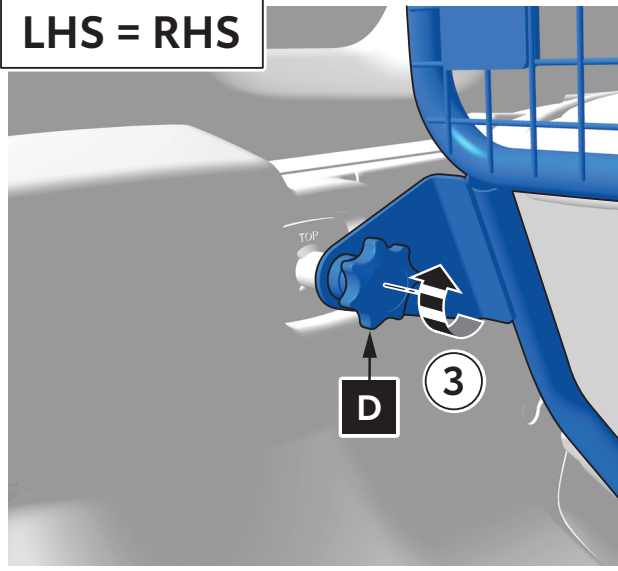

LHS = RHS

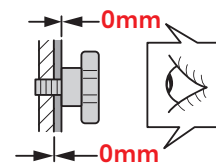
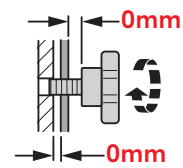
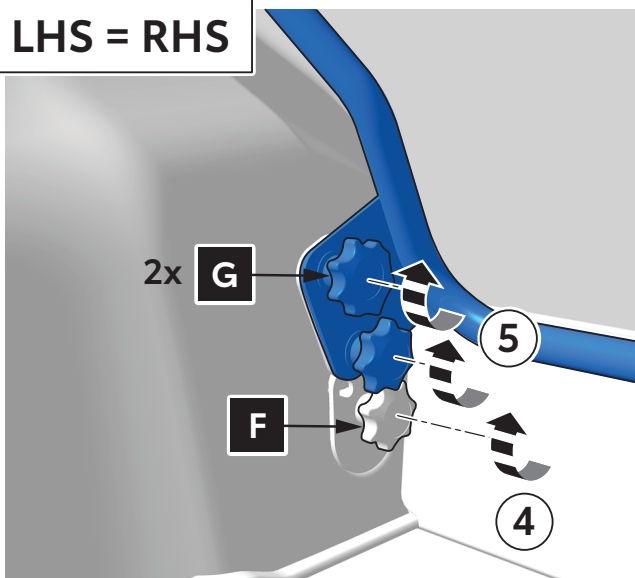

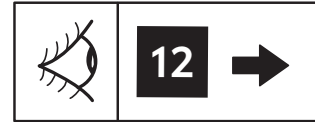

10

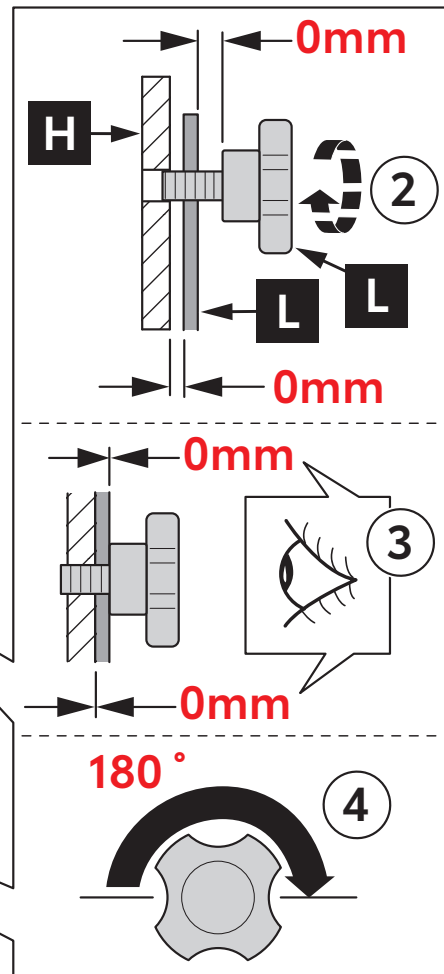
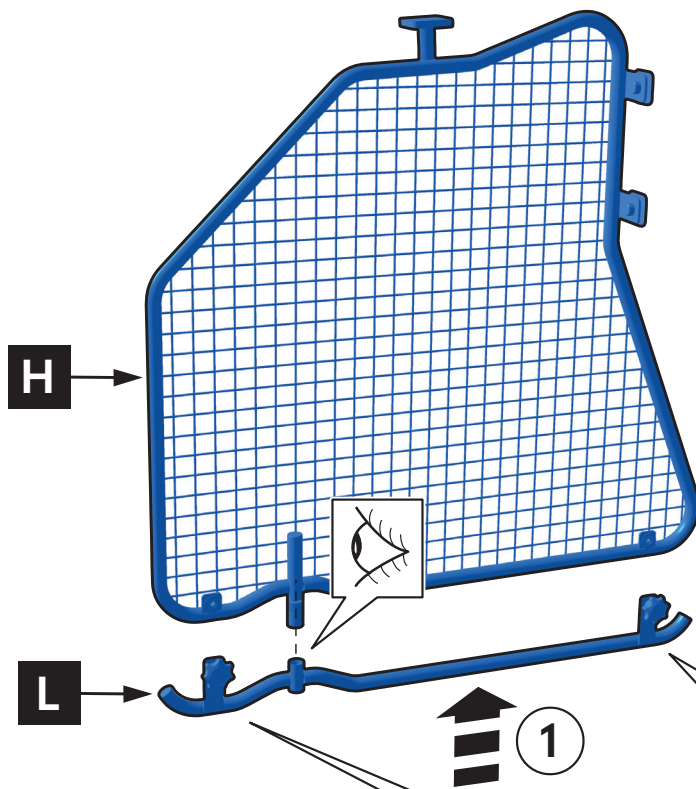

11

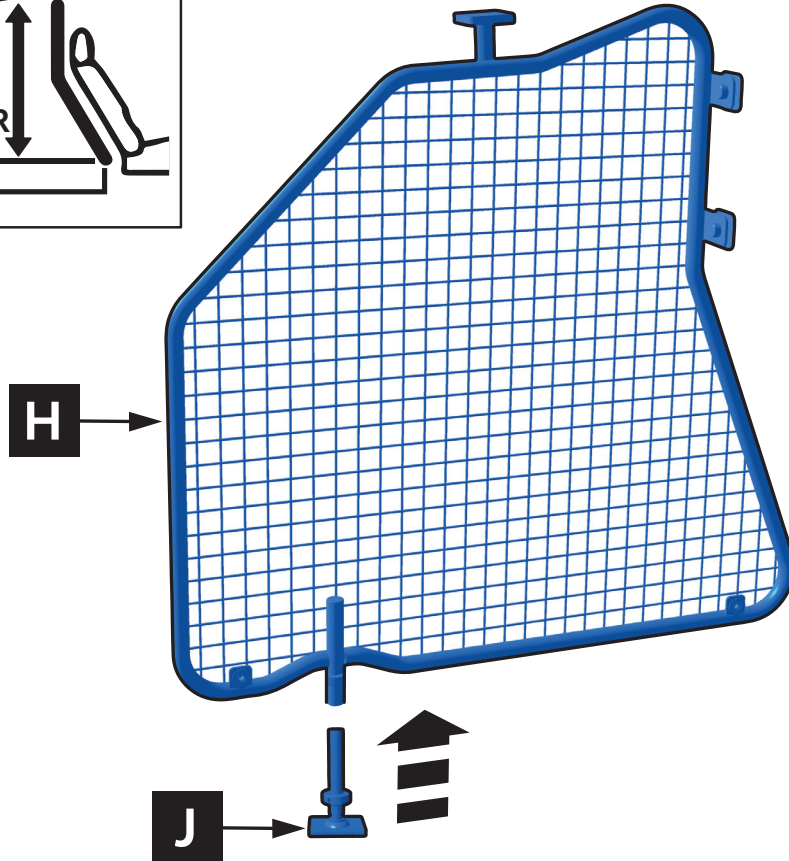
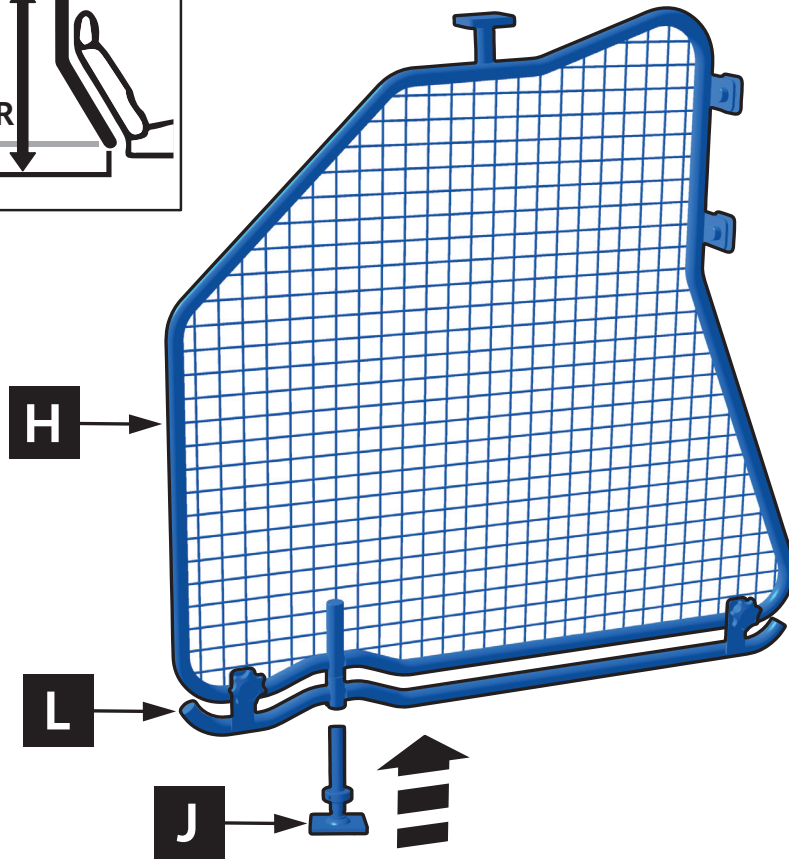
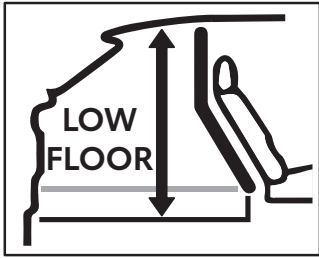

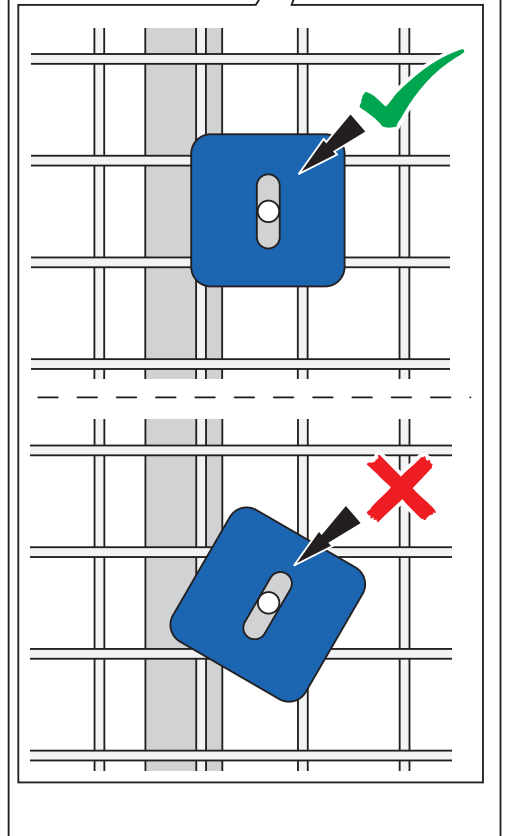
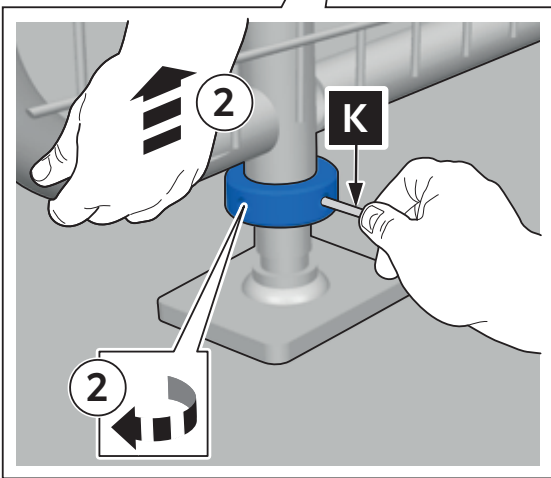
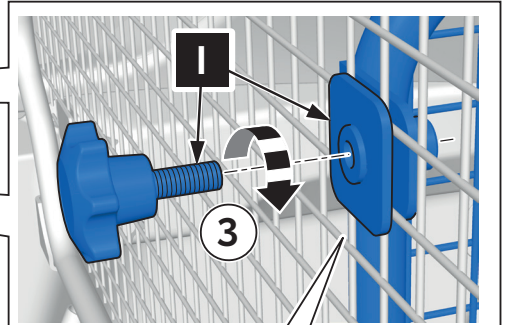
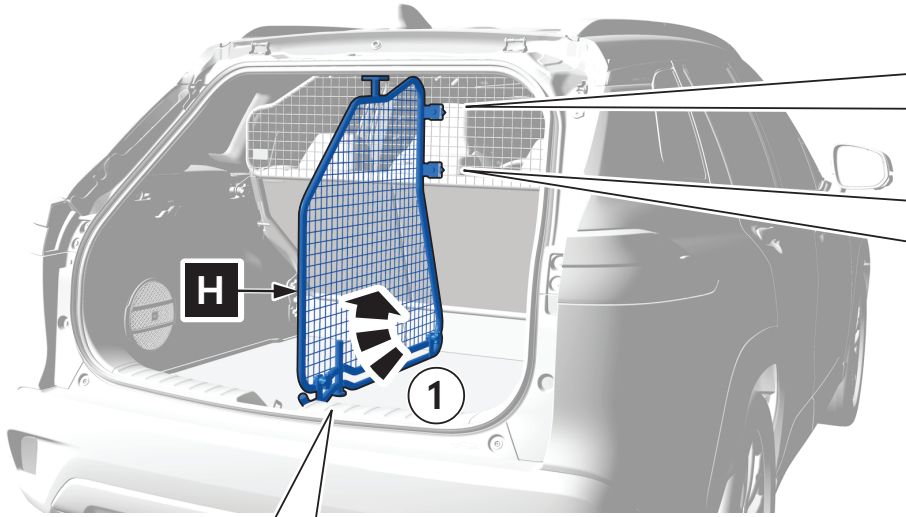

13

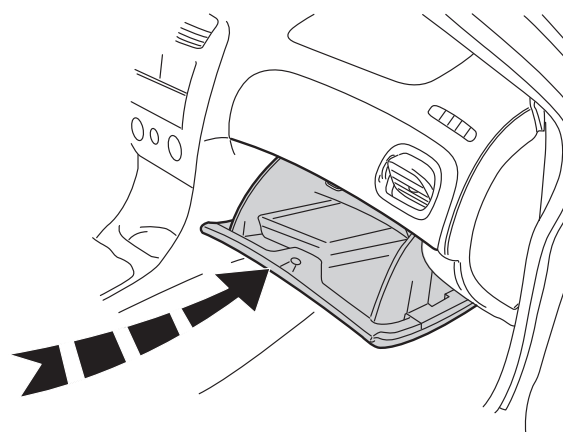
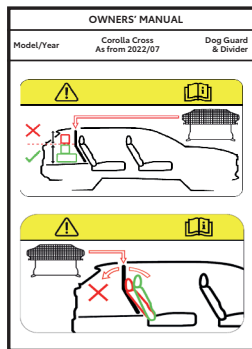
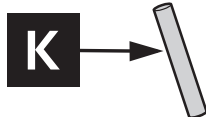

14

# OWNERS' MANUAL

Model/Year

Corolla Cross  
As from 2022/07

Dog Guard  
& Divider

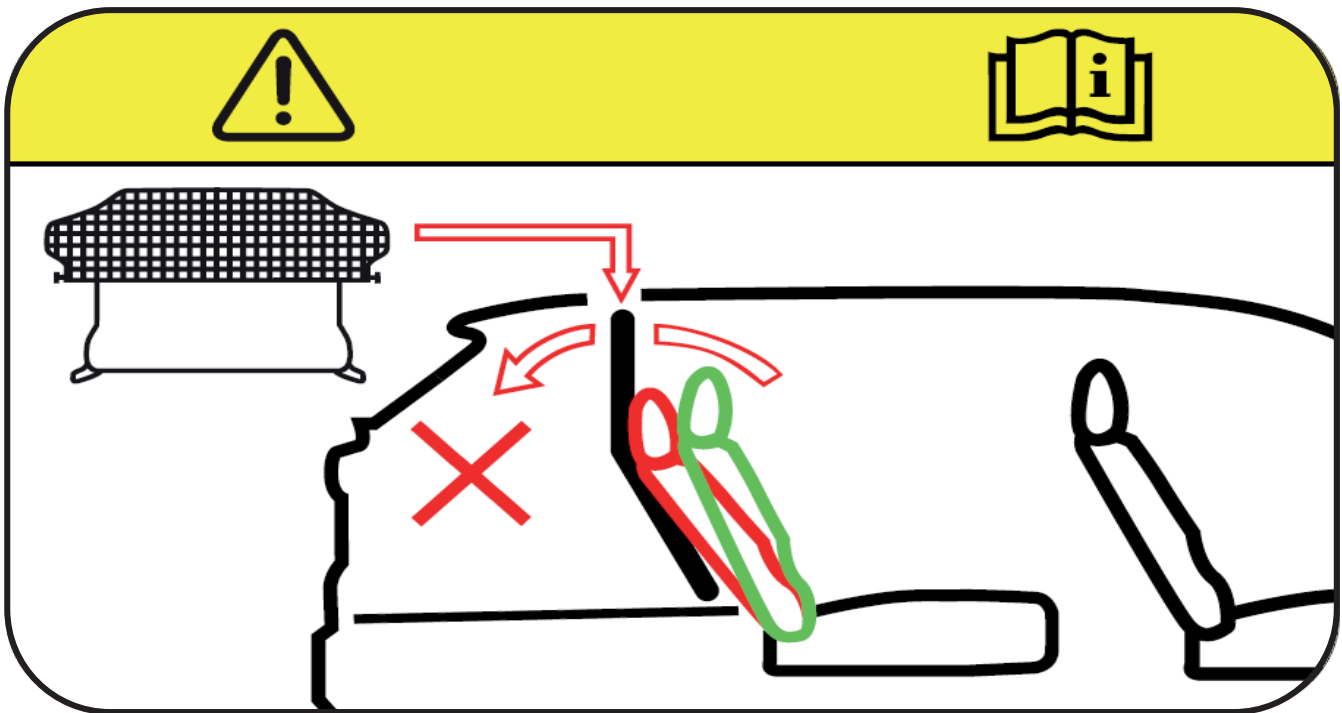
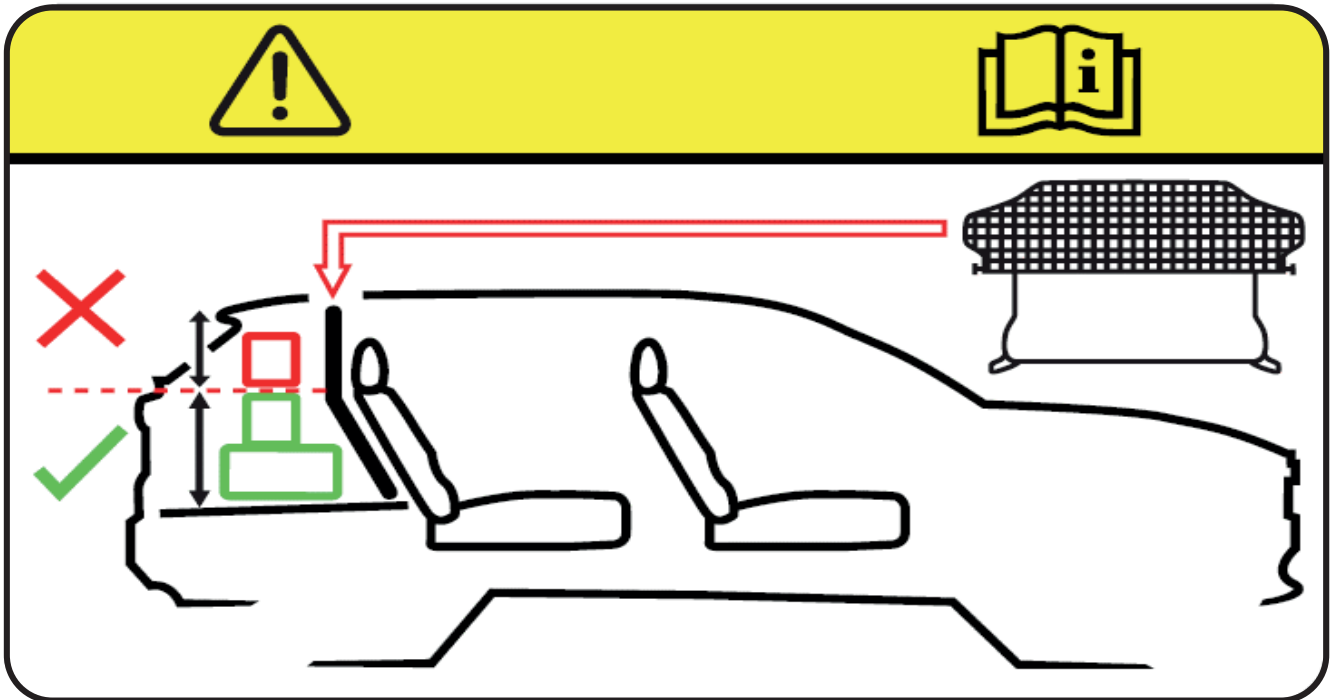

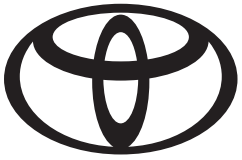

# CHECK SHEET

Page 1 of 2

Model/Year **Corolla Cross**  
**As from 2022/07**

**Dog Guard & Divider**

VINn°

## DURING INSTALLATION

**1**

= OK

P/N = OK

**2**

=

=

=

=



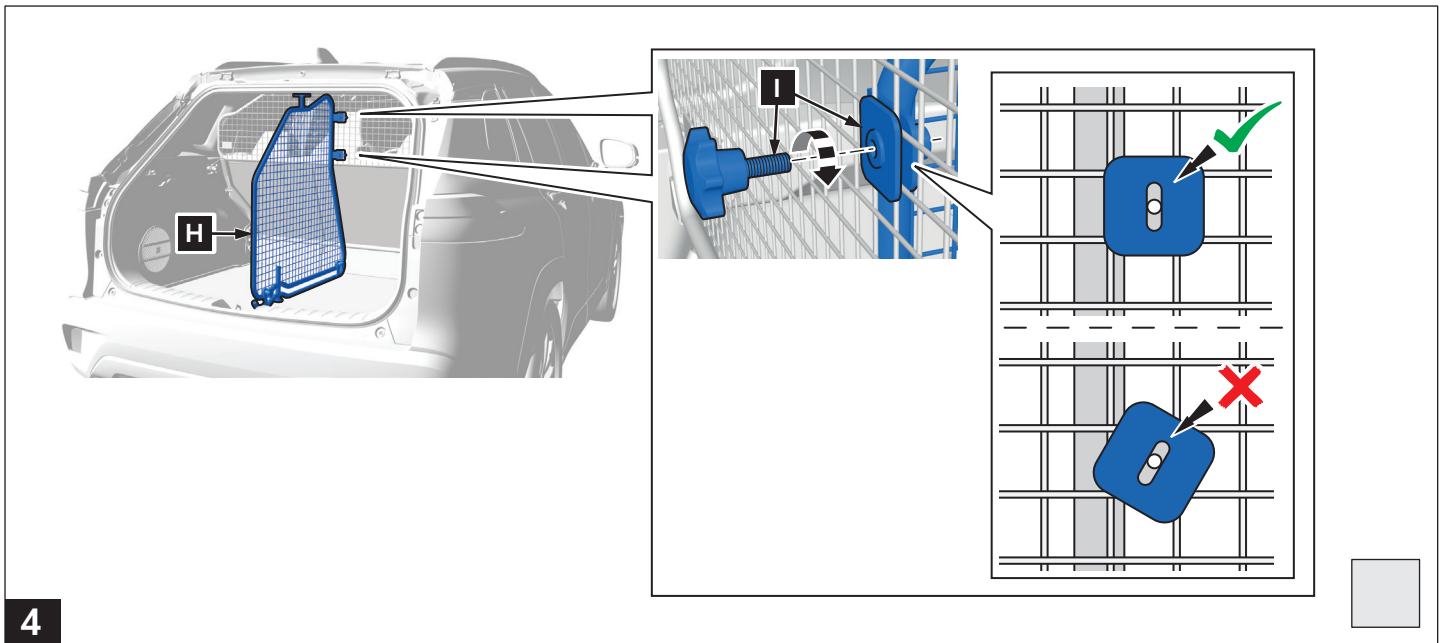
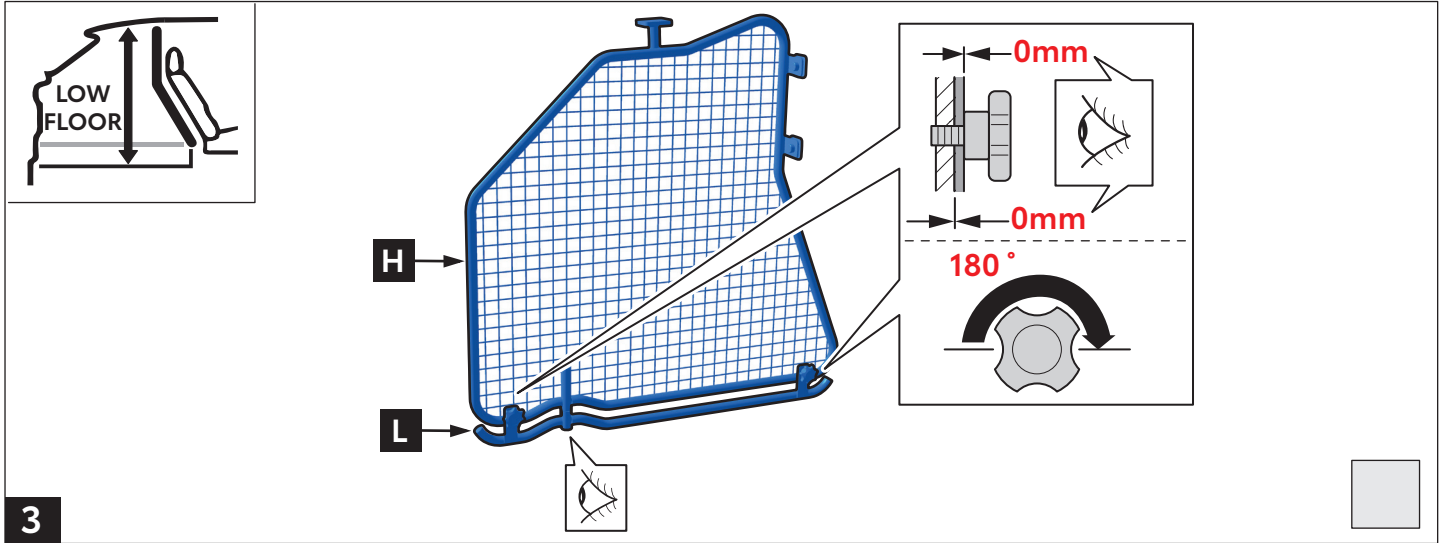

**AFTER INSTALLATION**

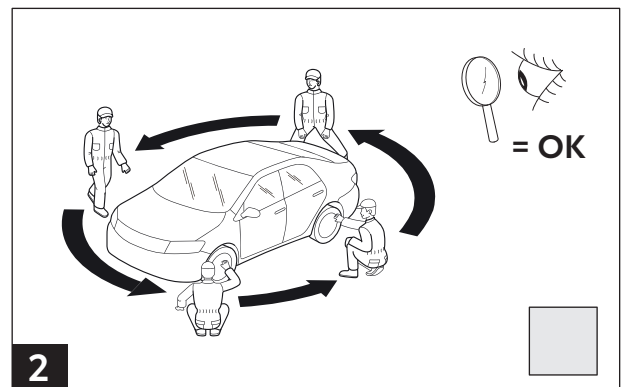
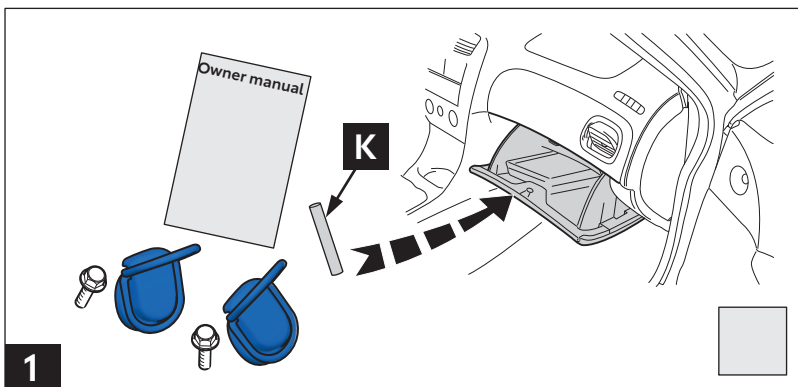

Installation Date:

. . / . . / . . . .

Technician Name & Signature:

Stamp: