

Rear Lower Trunk Garnish INSTALLATION INSTRUCTIONS NX

Model year As from 2021/09
Vehicle code *AZ*2**-AW*LBW
Part number PW405-78010-**
PW405-78020-**

**Latest Version
SCAN HERE**



Revision Record

Rev. No.	Date	Page	Step	Remarks
①	28.07.22	3		White knife added
①	28.07.22	4	2	AWD badge removal added
②	21.02.23	1, 2		Part number added

KIT CONTENT PW405-78010-** / PW405-78020-**

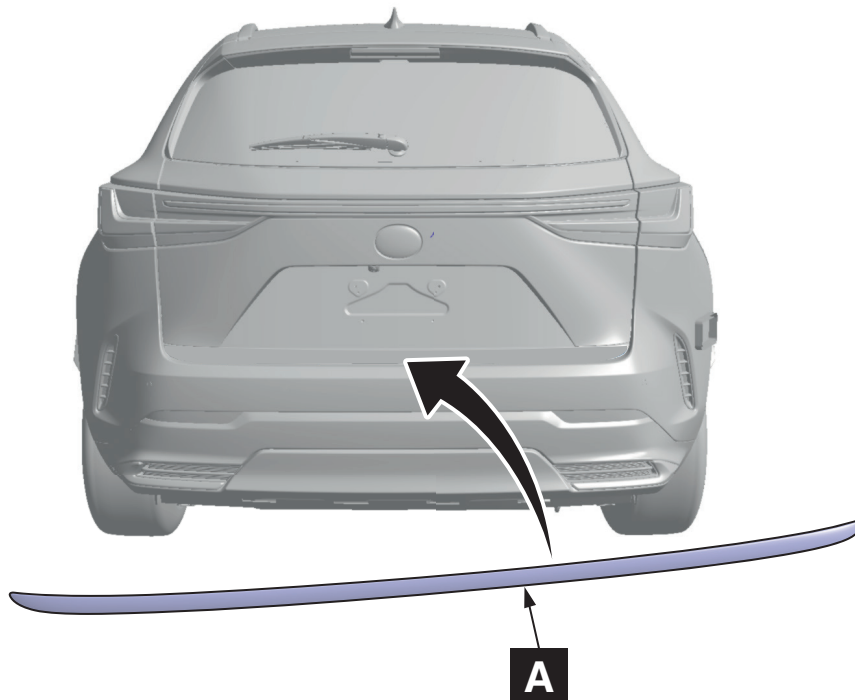

TOOLS

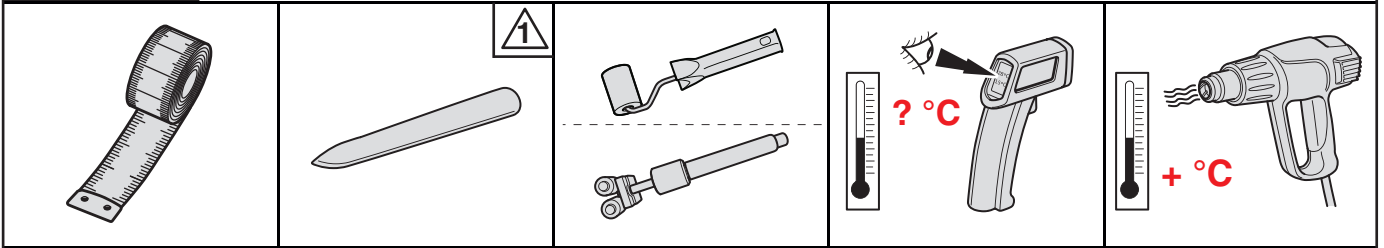



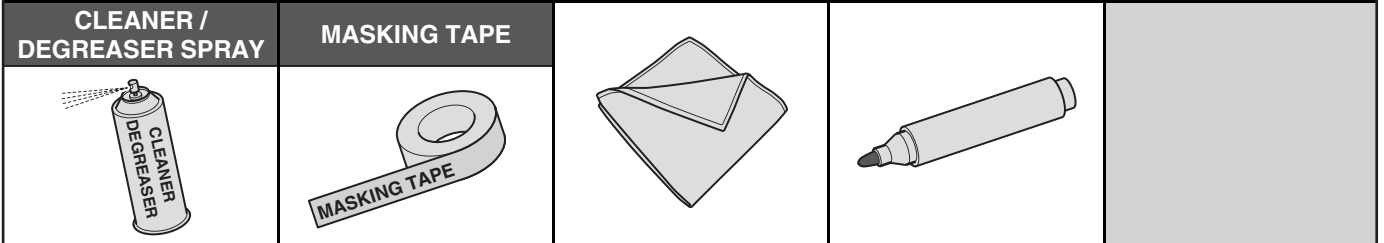

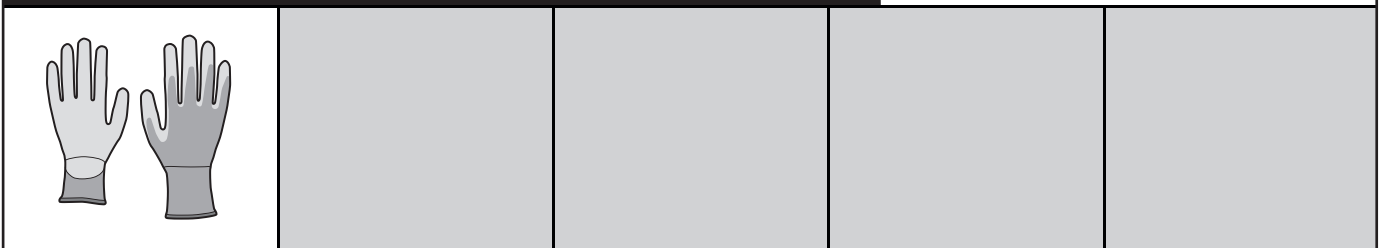

CONSUMABLES



PERSONAL PROTECTION EQUIPMENT

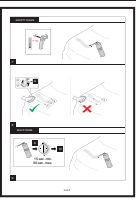

USEFUL GENERAL MANUALS

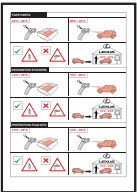
<p>SYMBOLS </p> <p>Latest Version SCAN HERE</p>  		<p>CLEANER / DEGREASER </p> <p>Latest Version SCAN HERE</p>  
<p>INSTALLATION CONDITIONS </p> <p>Latest Version SCAN HERE</p>  		

GENERAL



Material Safety Data Sheet



Technical Data Sheet

GENERAL

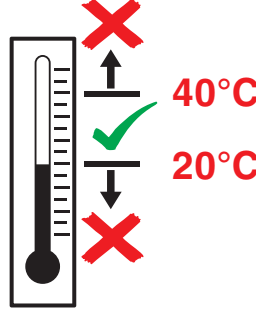
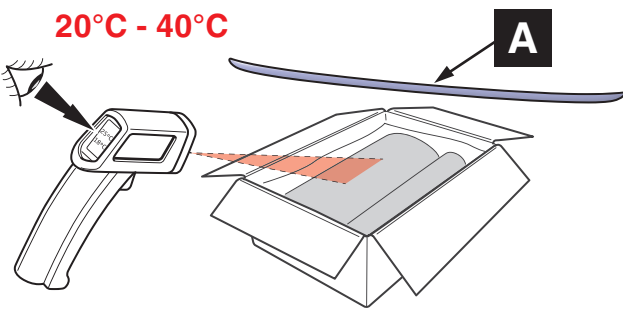
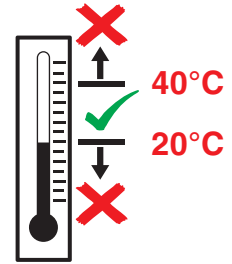
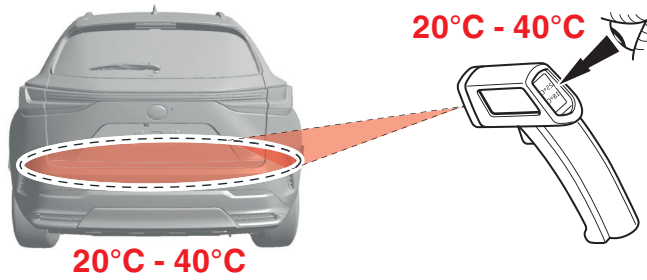

INSTALLATION INSTRUCTIONS

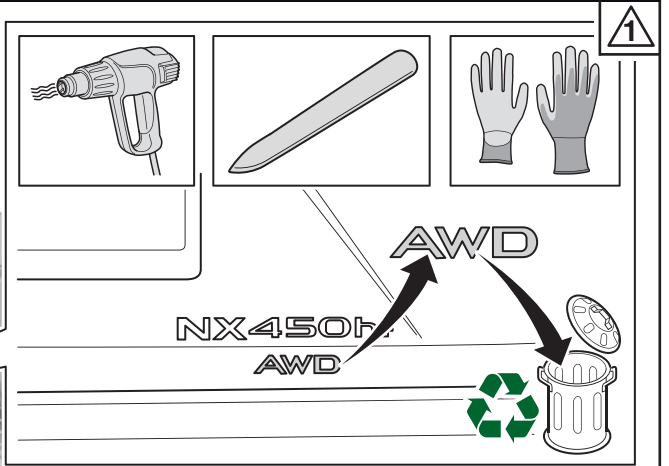
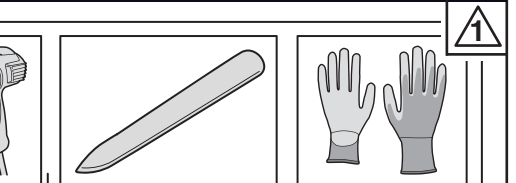
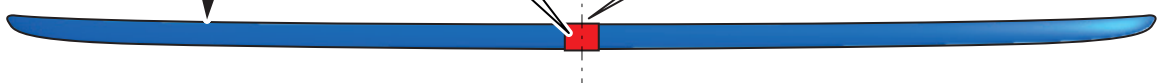
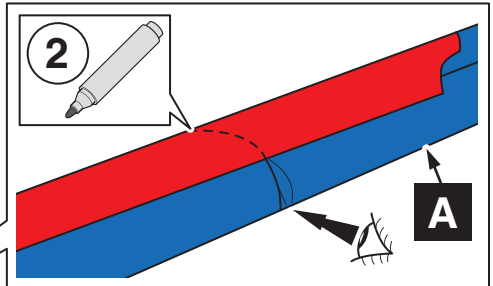

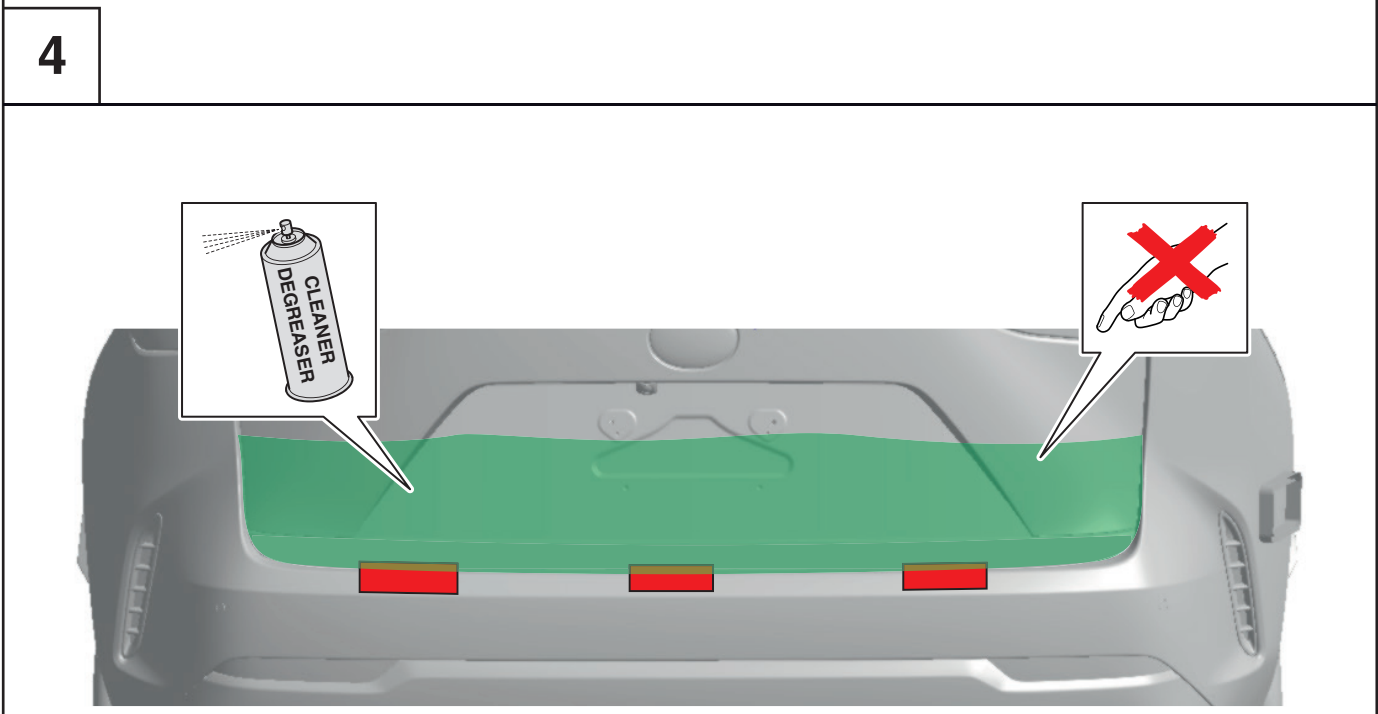
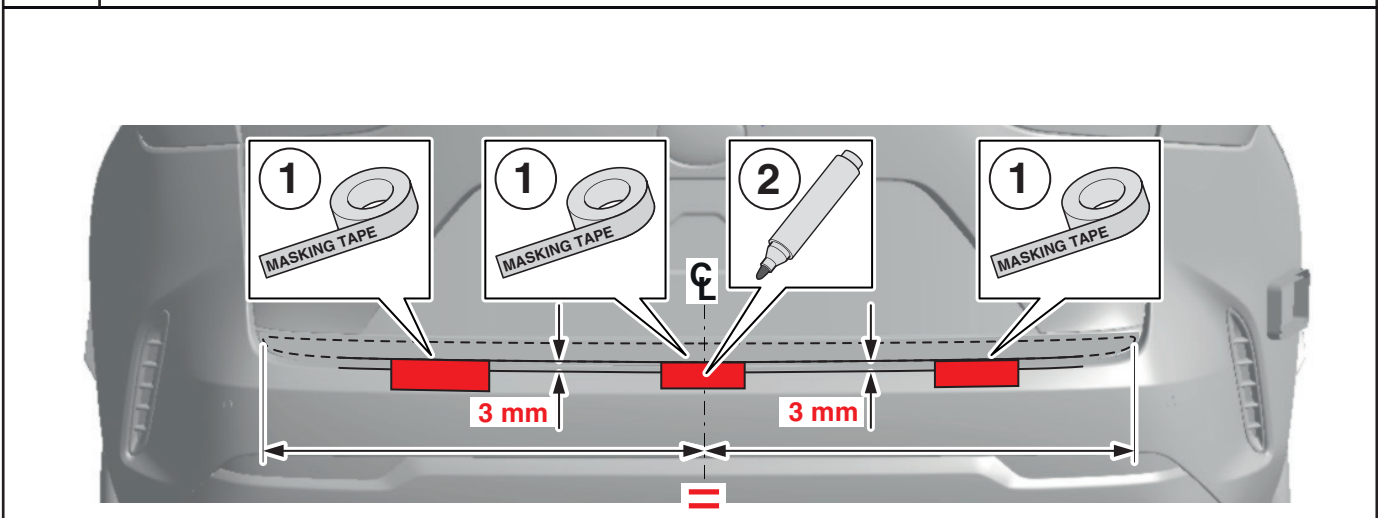
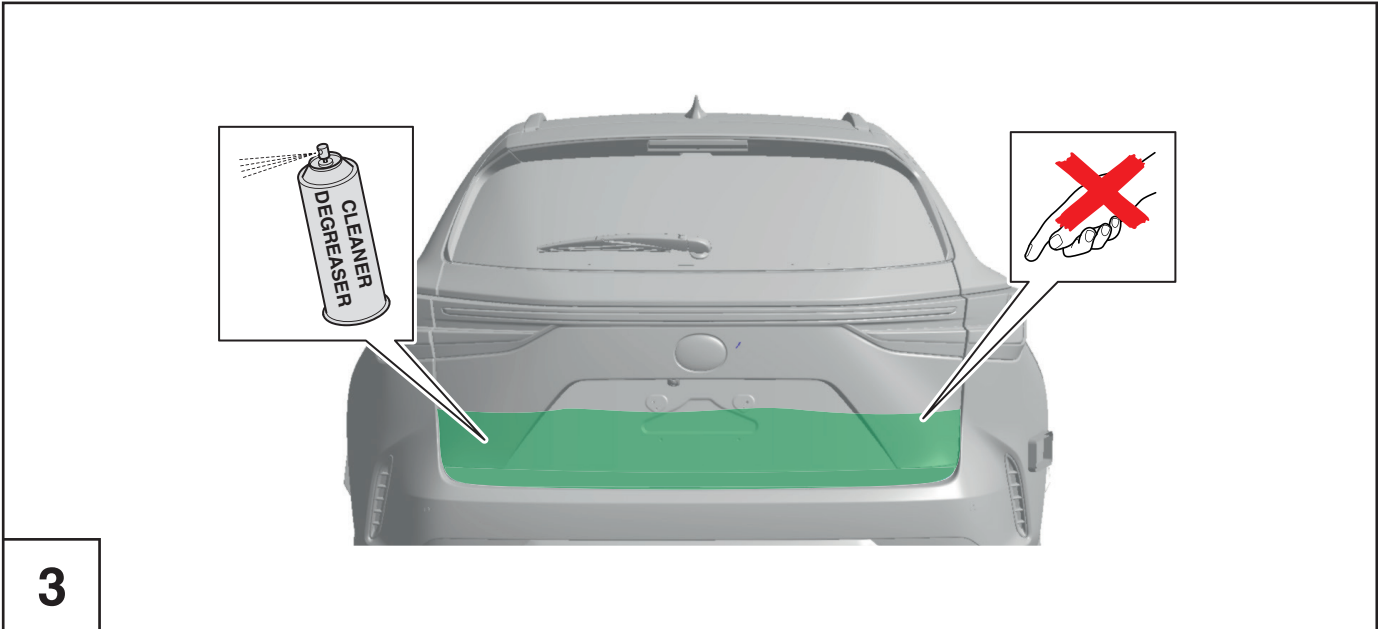

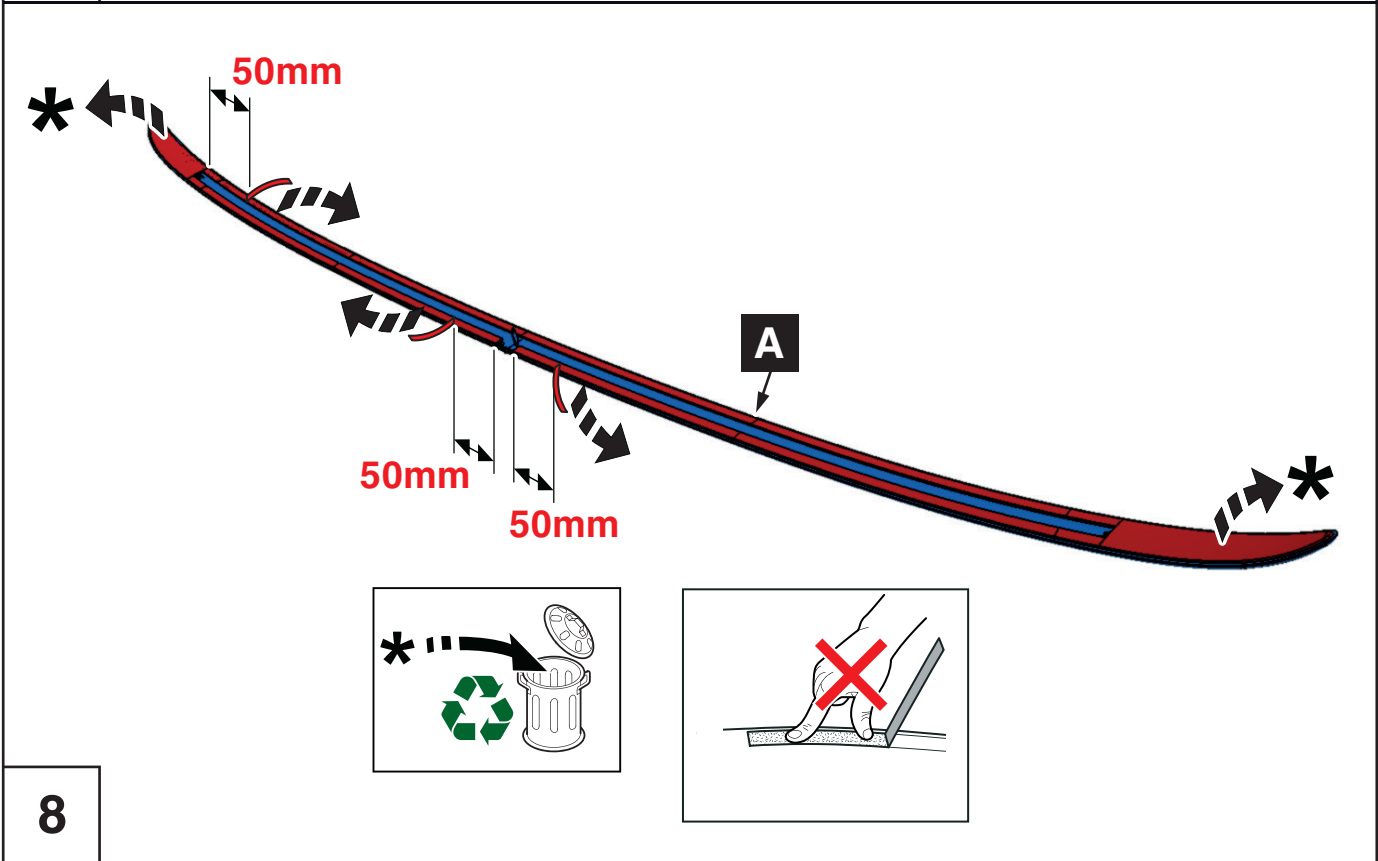
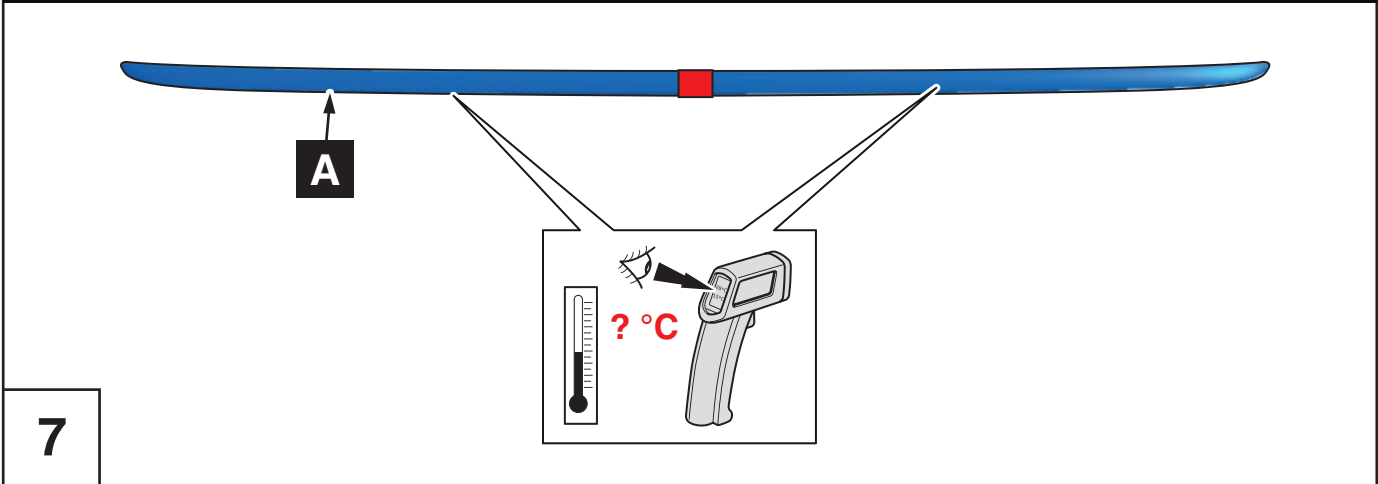
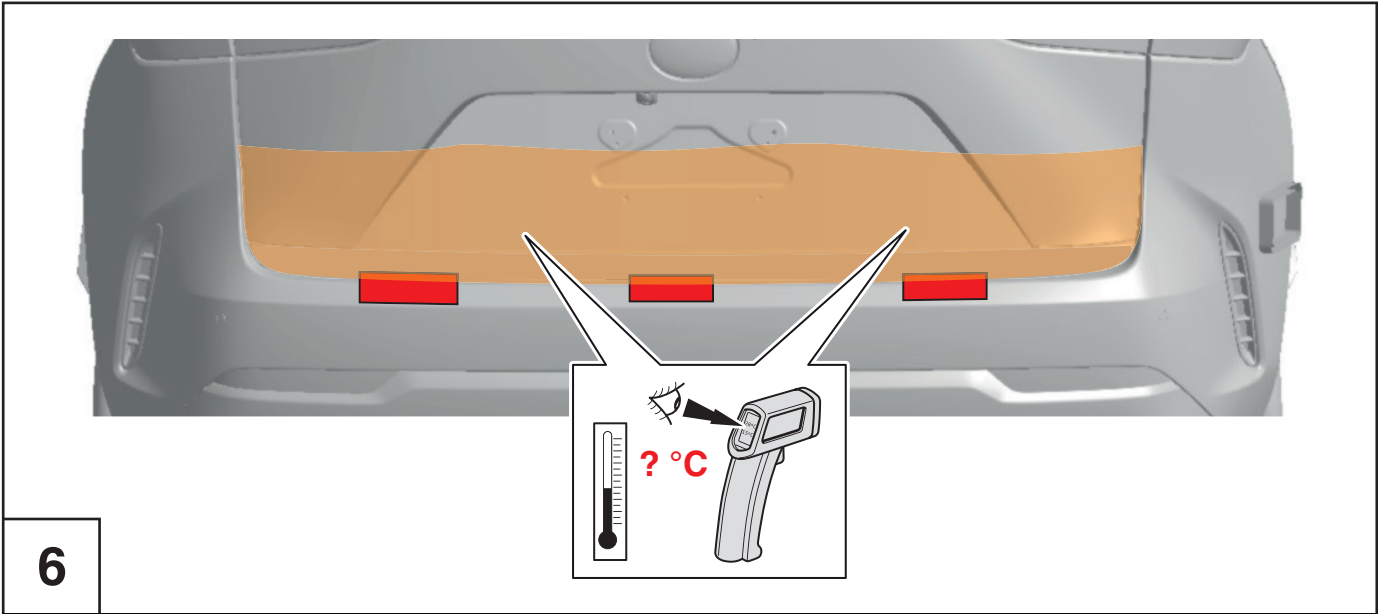

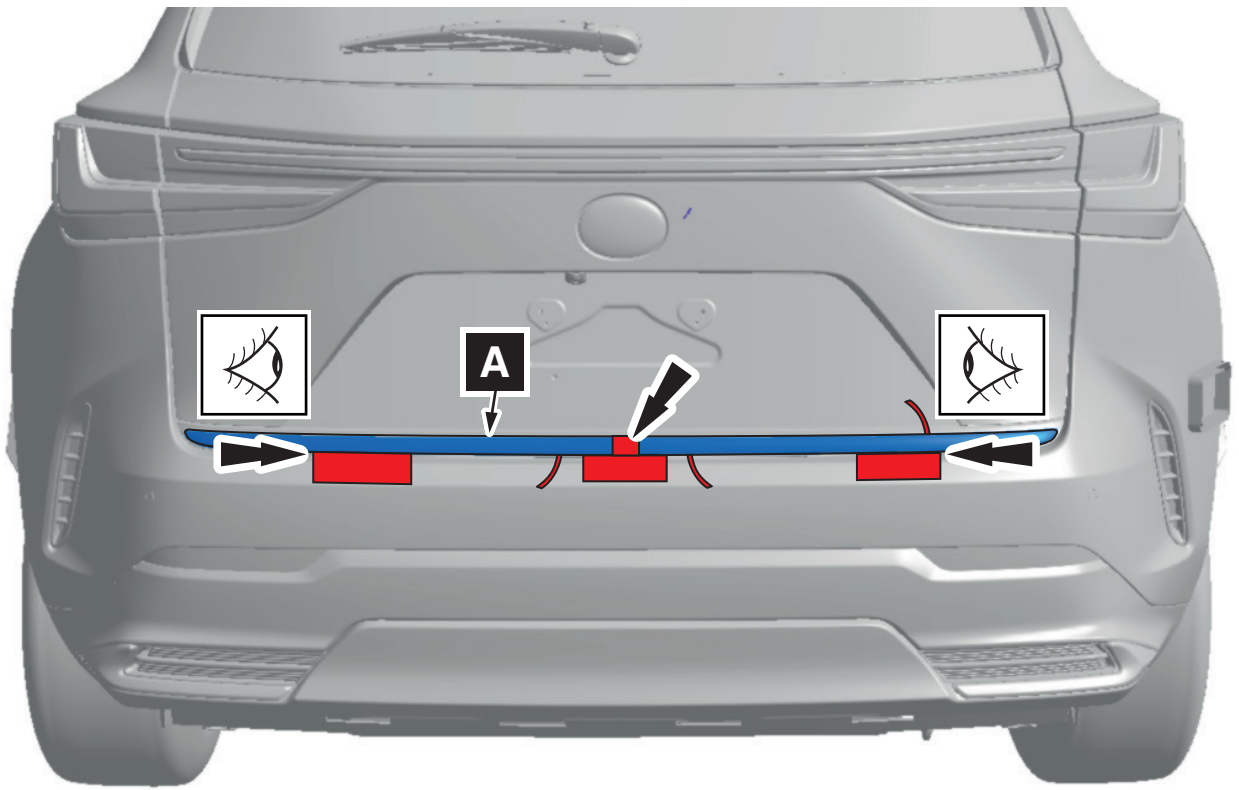

9

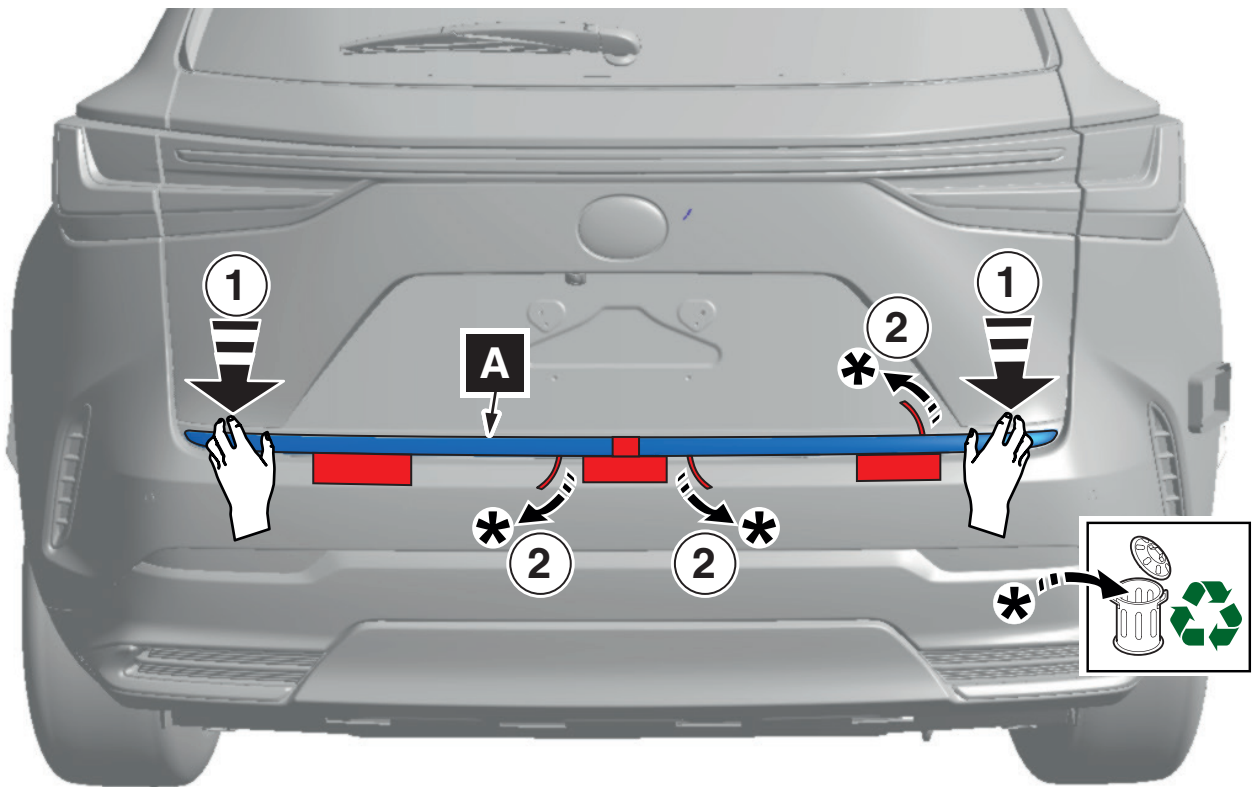

10

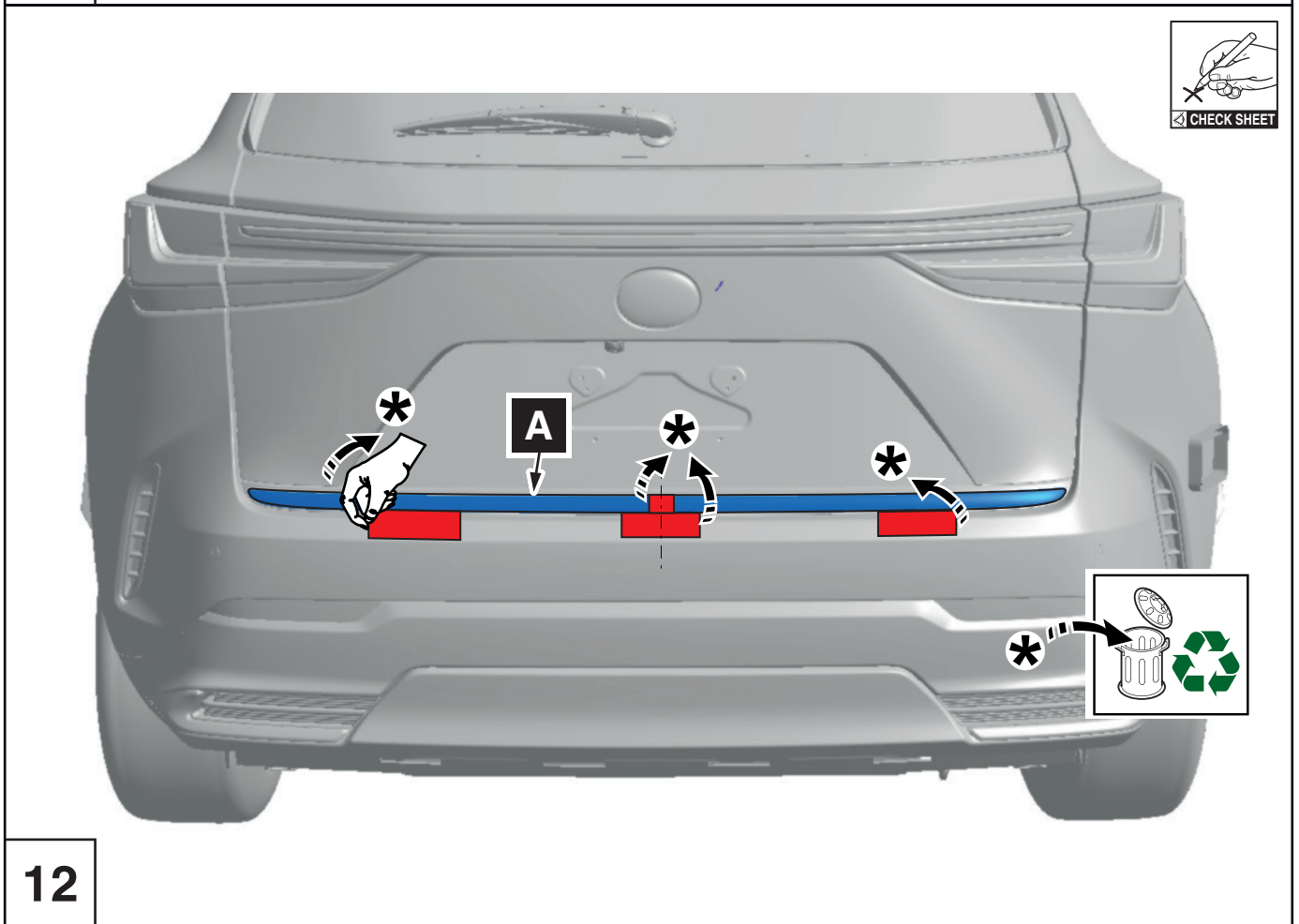
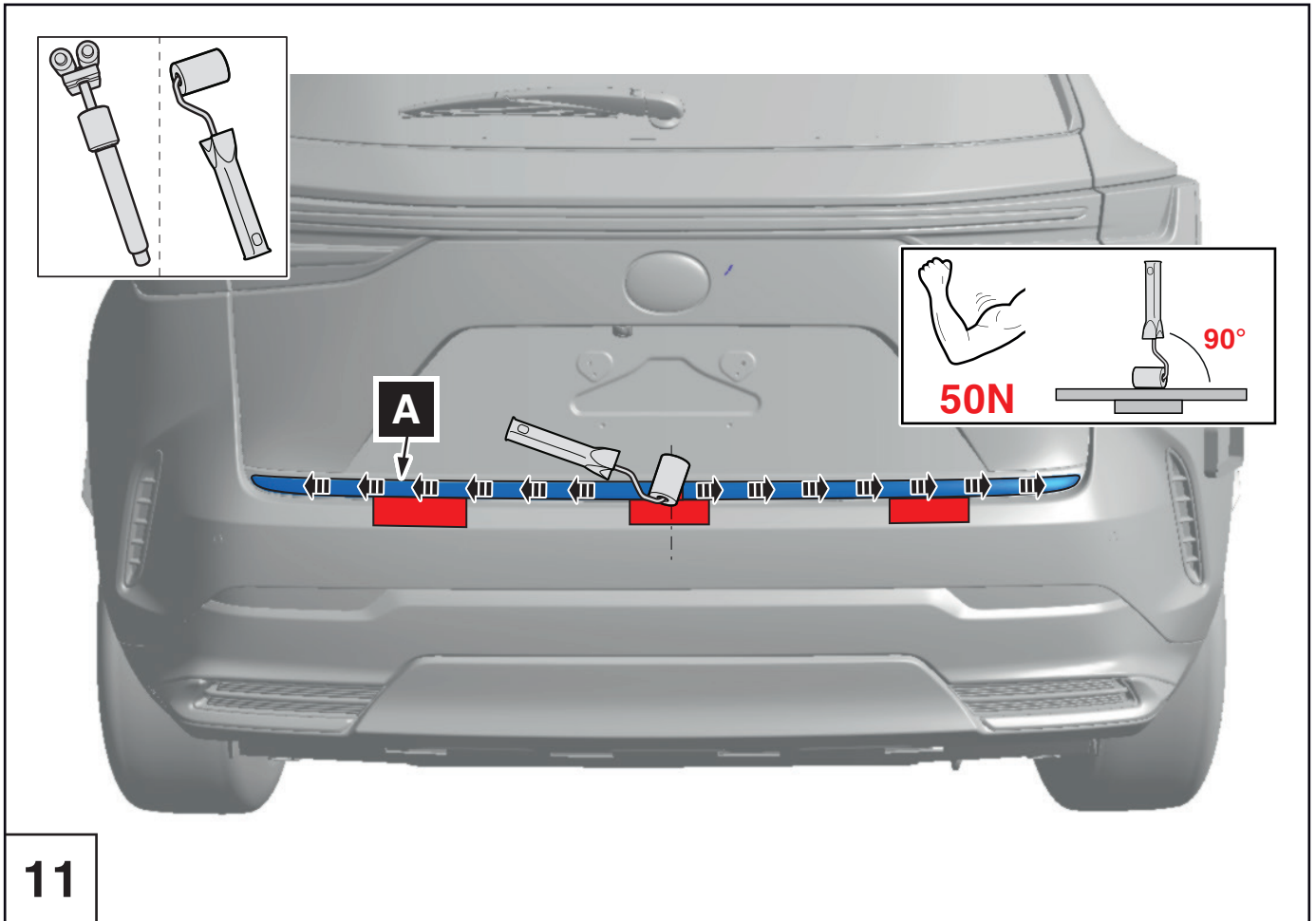



A

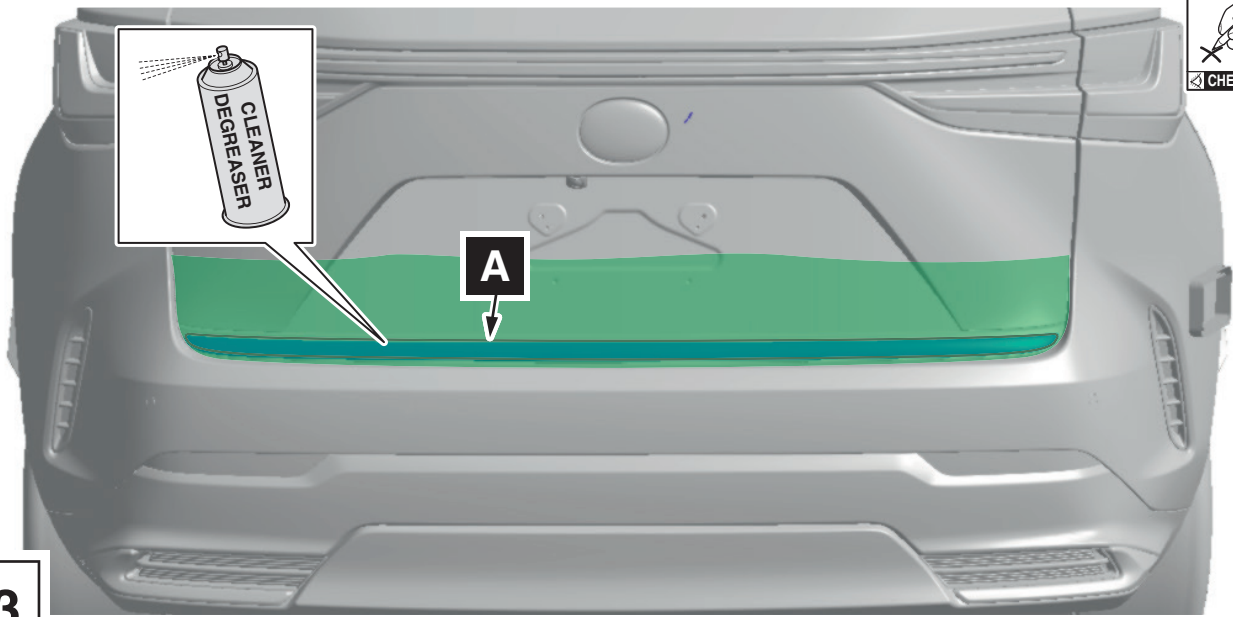

13

GENERAL

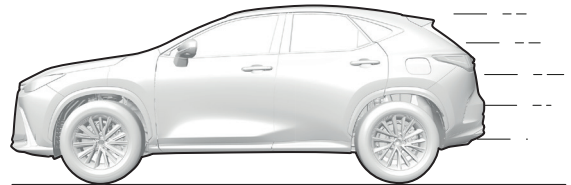
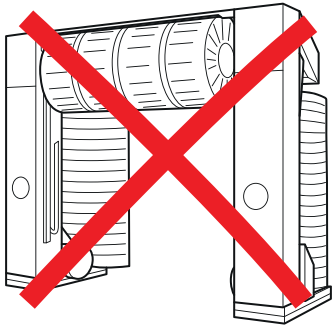
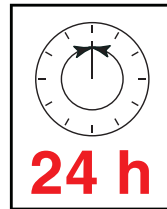
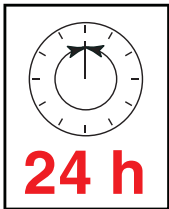
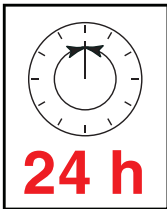

Max. 90 Km/h

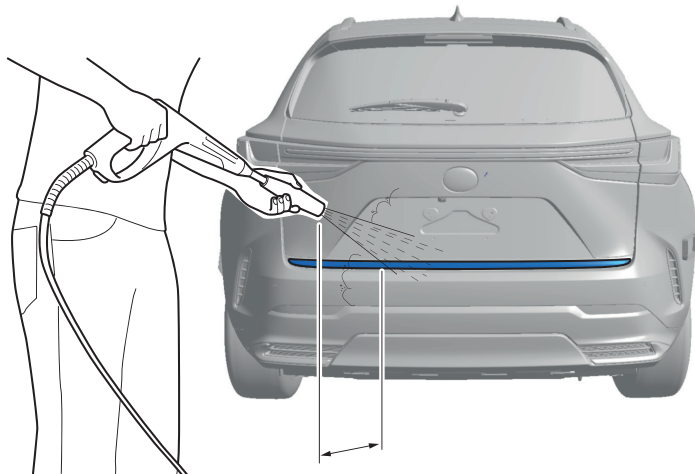

Minimum 50cm.

CHECK SHEET 1 of 2



Model / Year
NX As from 2021/09

Rear Lower Trunk Garnish

VIN n°

DURING INSTALLATION

1

= OK
P/N = OK

AFTER INSTALLATION

1

3 mm
3 mm

C
=

2

X
X

CHECK SHEET 2 of 2

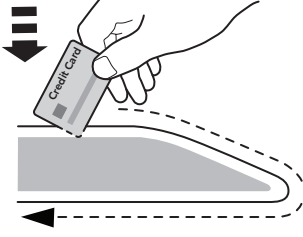

AFTER INSTALLATION

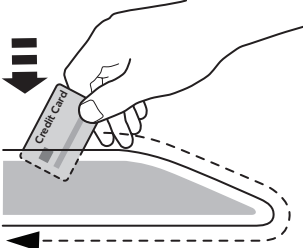
3

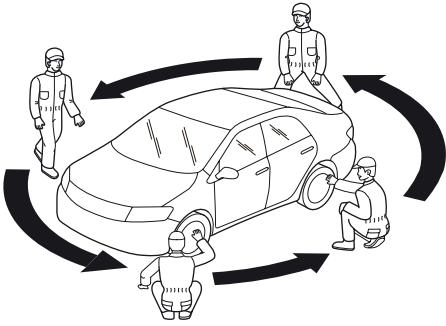

  = OK

4

Installation Date:

. . / . . /

Technician Name & Signature:

Stamp: