

LEATHER SEAT COVERS

INSTALLATION INSTRUCTIONS

COROLLA
VERSO

Model year: FMC 2004 / MMC 2007

Vehicle Code: **R1**-*****W

Part Number: PZ442-E8H5*-++

LHD/RHD

**For additional information
please refer to repair manual**

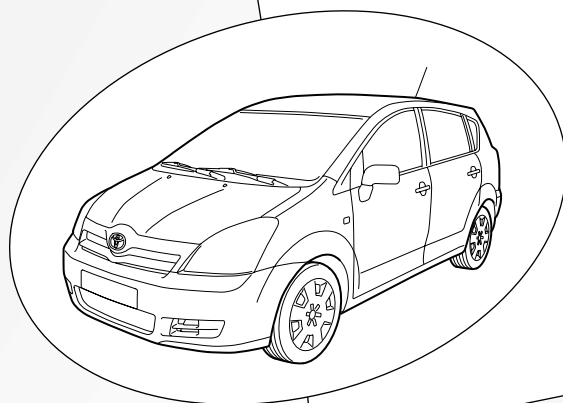

GB

- Expert Fitment Required.
- Disconnect the battery earth cable.
- Install parts as shown on illustrations.
- Re-connect battery.
- Re-fit panels, ensure that the wiring harness and other components are neatly and securely located.

D

- Montage durch Fachwerkstatt erforderlich.
- Massekabel von Batterie abklemmen.
- Teile gemäß Abbildung montieren.
- Batterie wieder anschließen.
- Paneele wieder anbringen; achten Sie darauf, daß der Kabelbaum und andere Teile ordnungsgemäß und genau positioniert sind.

E

- Montaje sólo por el concesionario.
- Desconectar el cable de masa de la batería.
- Montar las piezas tal como se indica en las figuras.
- Vuelva a conectar la batería.
- Volver a colocar los paneles; preste atención a que el mazo del cable y las demás piezas tengan la posición correcta y precisa.

F

- Montage par spécialiste nécessaire.
- Débrancher le câble de masse de la batterie.
- Monter les pièces selon les figures.
- Reconnecter la batterie.
- Remettre le panneau; veillez à ce que le faisceau et les autres pièces soient positionnés correctement et avec la précision requise.

I

- E' necessario in officina specializzata.
- Staccare il cavo di massa dalla batteria
- Montare le parti secondo quanto rilevabile delle illustrazioni.
- Riconnettere la batteria.
- Rimettere in posizione i pannelli; far ben attenzione che il fascio di cavi e le altre parti siano state posizionate con esattezza e nella dovuta maniera.

P

- Especialista em montagem requerido.
- Separe o cabo de terra do acumulador.
- Monte as partes conforme ilustrado.
- Recolocar a bateria
- Tornar a colocar os painéis; verificar se a árvore de cabos e outras peças estão na posição exacta e prescrita.

NL

- Montage door vakman nodig.
- Massakabel van accu losmaken.
- Delen overeenkomstig afbeelding monteren.
- Accu weer aansluiten.
- Panelen weer monteren; let erop, dat de kabelboom en andere delen correct en netjes ge-positioneerd worden.

DK

- Montage ved professionelt værksted påkrævet.
- Stelkabel fjernes fra batteri.
- Dele skal monteres i henhold til illustrationer.
- Tilslut batteri igen.
- Paneler fastgøres igen; vær opmærksom på, at kabelsamlingen og andre dele placeres korrekt og præcist.

N

- Nødvendig med montering fra fagverksted.
- Klem jordkabelen av batteriet.
- Monter alle deler i henhold til illustrasjonene.
- Tilkobl batteriet igjen.
- Monter panelene igjen, og pass på at kabelbunten og andre deler er anbrakt ordentlig og på riktig sted.

S

- Verkstadsmontage erfordras.
- Lossa stomkabeln från batteriet.
- Montera detaljerna enligt figurerna
- Anslut batteriet igen.
- Sätt tillbaka panelerna igen; kontrollera noga att ledningsmattan och andra detaljer ligger på rätt plats.

FIN

- Asennus tarpeen merkkikorjaamossa.
- Erotta maadoitusjohto akusta
- Asenna osat kuvien mukaan.
- Kytke akku takaisin.
- Aseta paneelit paikalleen; tarkista, että kaapelointi ja muut osat ovat asianmukaisesti ja tarkalleen paikoillaan.

CZ

- Montáž ve specializované dílně nutná.
- Odpojte zemnicí kabel od baterie.
- Montujte části podle vyobrazení
- Opět připojit baterii.
- Opět připevněte panely; dbejte na to, aby svazek kabelů a ostatní části byly uloženy na správném místě.

H

- A szereléshez szakműhely kell.
- Húzza le az akkumulátor testkábeljét.
- Az alkatrészeket az ábrák szerint szerelje be.
- Ismét csatlakoztassa az akkumulátort.
- Szerelje vissza a fedőlapokat, ügyeljen arra, hogy a kábelek és a többi alkatrészek pontosan a számukra kijelölt helyen maradjanak.

PL

- Konieczny montaż przez warsztat specjalistyczny.
- Odłączyć przewód masy od akumulatora.
- Zamontować części zgodnie z rysunkiem.
- Ponownie podłączyć akumulator.
- Na powrót osadzić osłony; zadbać aby wiązka kablowa i inne części były właściwie i dokładnie ułożone.

GR

- Να τοποθετεί από συνεργείο.
- Αποσυνδέστε το καλώδιο γείωσης από τη μπαταρία.
- Τοποθέτηση των μερών σύμφωνα με τις Εικόνες.
- Συνδέστε πάλι τη μπαταρία.
- Τοποθετήστε πάλι το κάλυμμα· προσοχή, η πλεξούδα καλωδίων και άλλα μέρη να είναι τοποθετημένα ακριβώς και σύμφωνα με τους κανονισμούς.

| | | Black N₁1 pleated | Alcantara N₁ 9052 | MODELCODES |
|----------|---------|-------------------------------------|-------------------------------------|-------------------|
| 5 seater | D-grade | PZ442-E8C5G-KT | PZ442-E8C5G-KF | **R1**-GW*D*W |
| | E-grade | PZ442-E8C5G-LT | PZ442-E8C5G-LF | **R1**-GW*E*W |
| 7 seater | D-grade | PZ442-E8C5E-KT | PZ442-E8C5E-KF | **R1**-GR*D*W |
| | E-grade | PZ442-E8C5E-LT | PZ442-E8C5E-LF | **R1**-GR*E*W |
| N1 | D-grade | PZ442-E8C5K-KT | PZ442-E8C5K-KF | **R1**-G**D*W |
| | E-grade | PZ442-E8C5K-LT | PZ442-E8C5K-LF | **R1**-G**E*W |

Kit content

| | |
|--|-----------|
| 2 Front Seat | } N1 Kits |
| 2 Front Backrest w/ armrest for E-grade or w/o armrest for D-grade | |
| 2 Front Headrest | |
| 2 front doorpanels | |
| 2 Rear side seats | |
| 1 Rear central Seat | |
| 1 Rear Backrest | |
| 3 Rear Headrest | |
| 2 rear doorpanels | |
| 2 Rear Nr 2 seats only applicable to 7 seater | |
| 2 Rear Nr 2 backrests only applicable to 7 seater | |
| 2 Rear Nr 2 Headrest only applicable to 7 seater | |

A

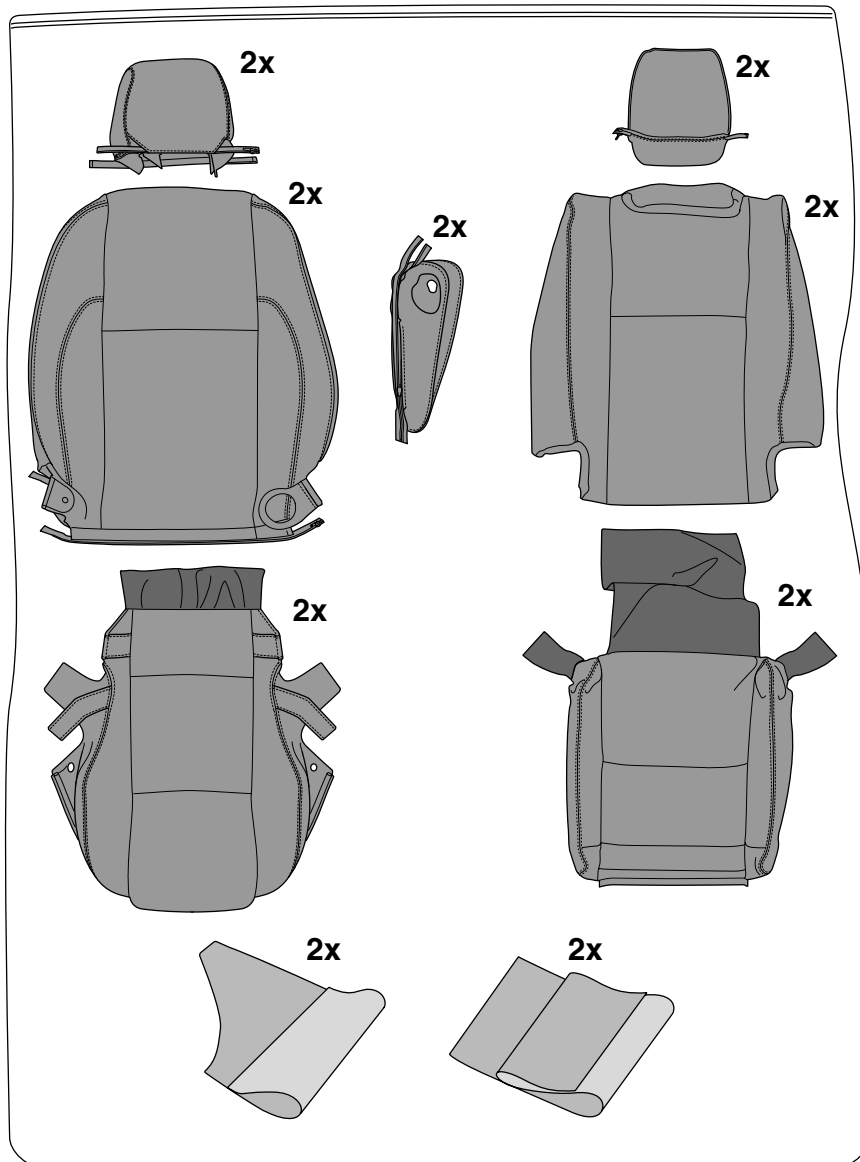

B

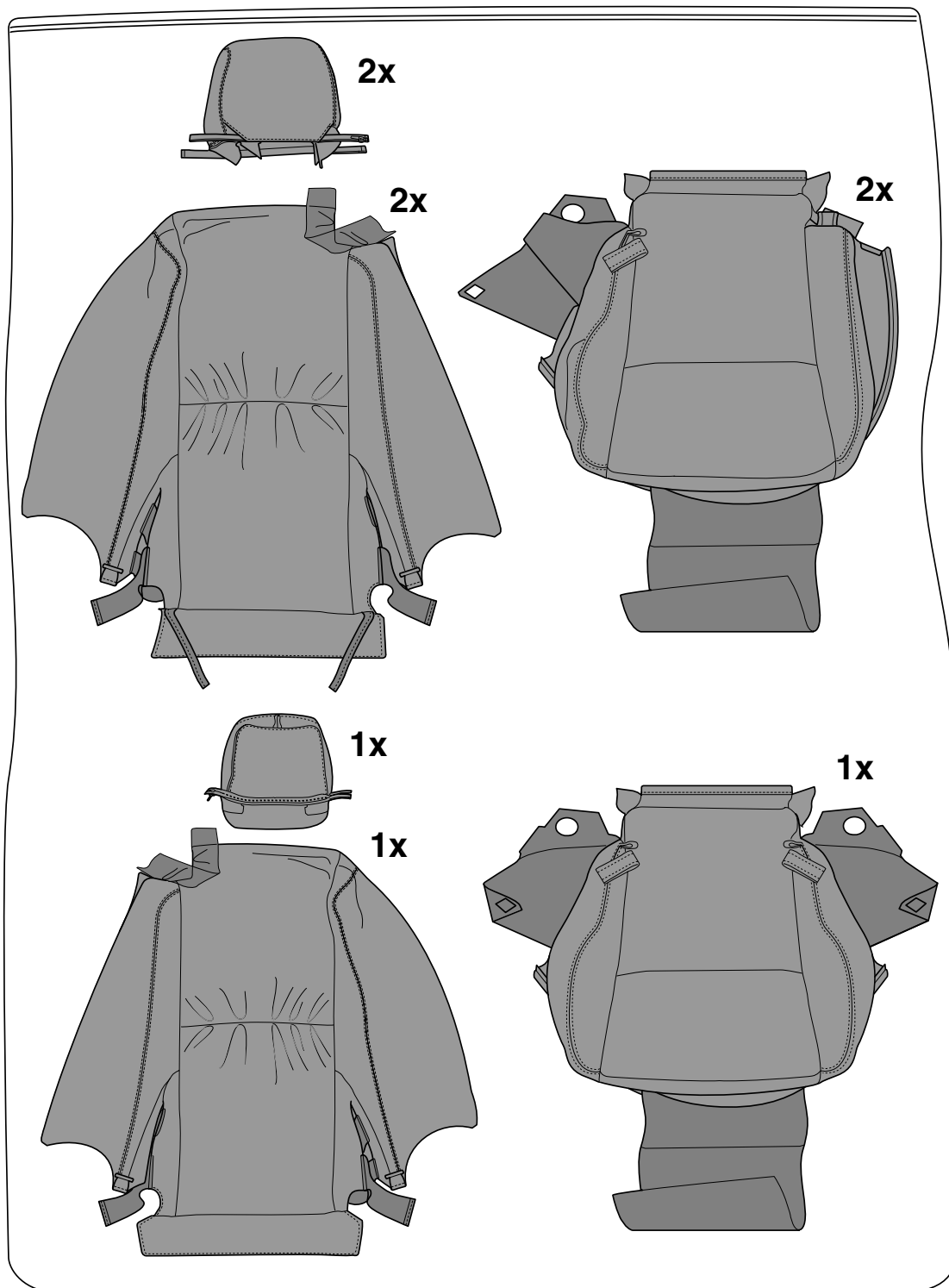

TOOLS



12 mm
14 mm

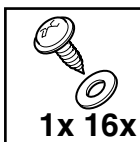
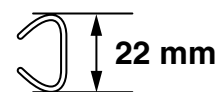
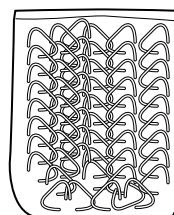
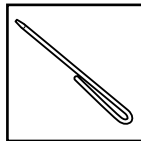
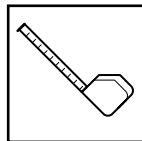
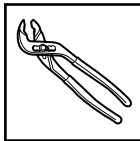
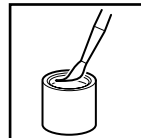
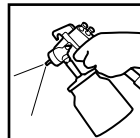
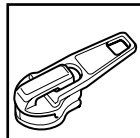
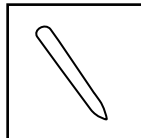
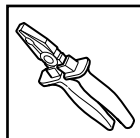
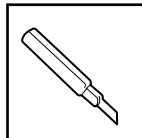
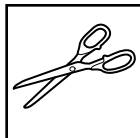
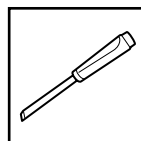
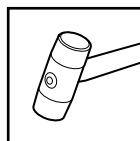
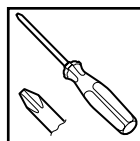
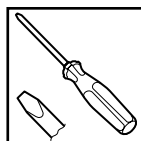
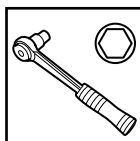
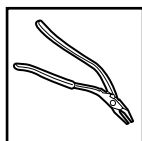
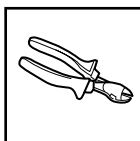

1x 16x

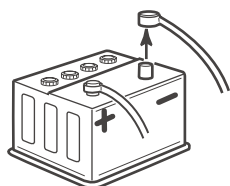

$\geq 90''$



Airbag

1

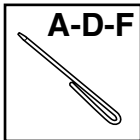

A-D-F

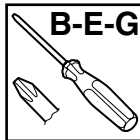

B-E-G

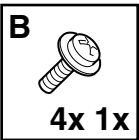

B

4x 1x

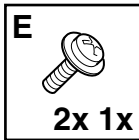

E

2x 1x

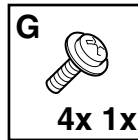

G

4x 1x

L + R

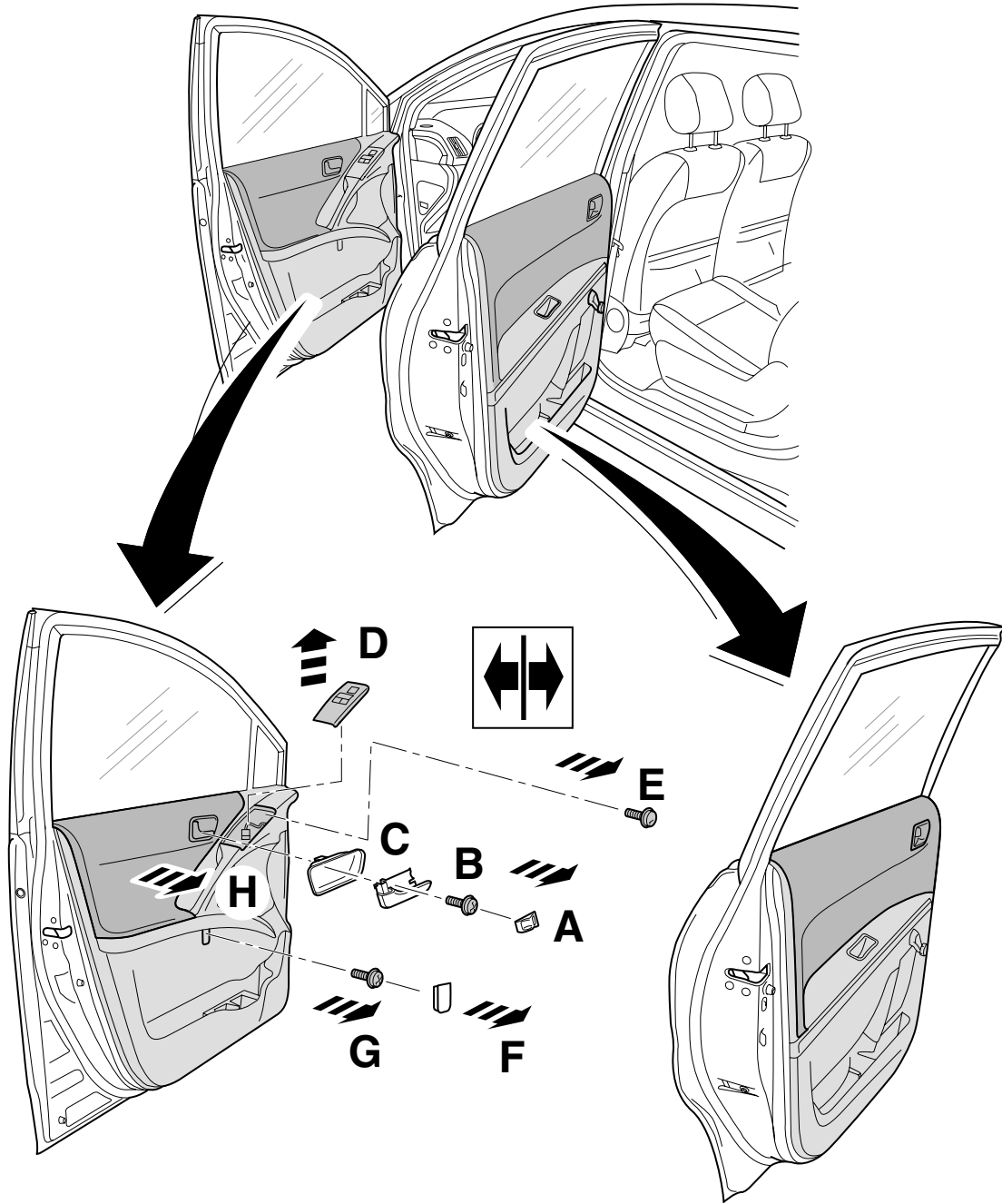

2

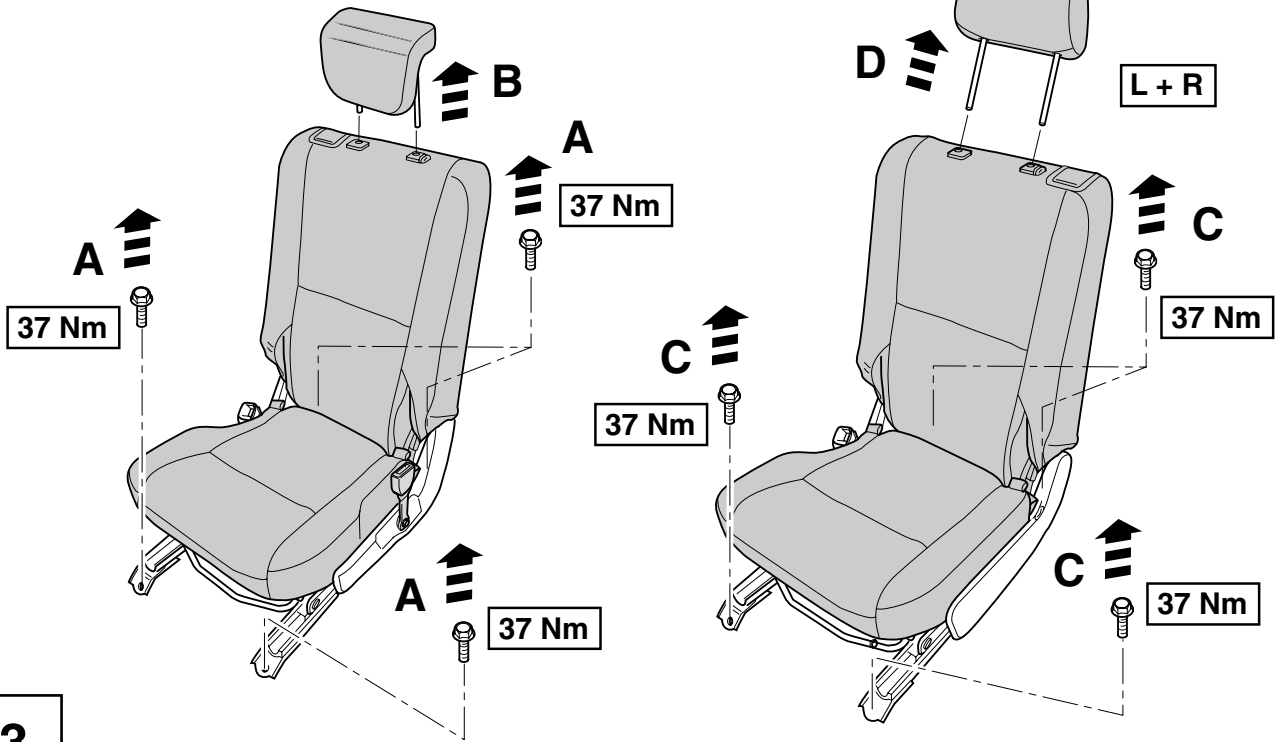
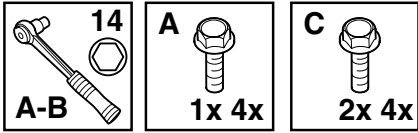

3

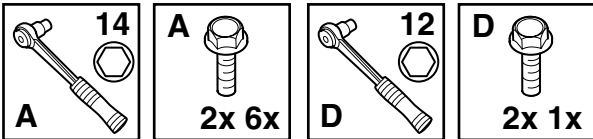

L + R

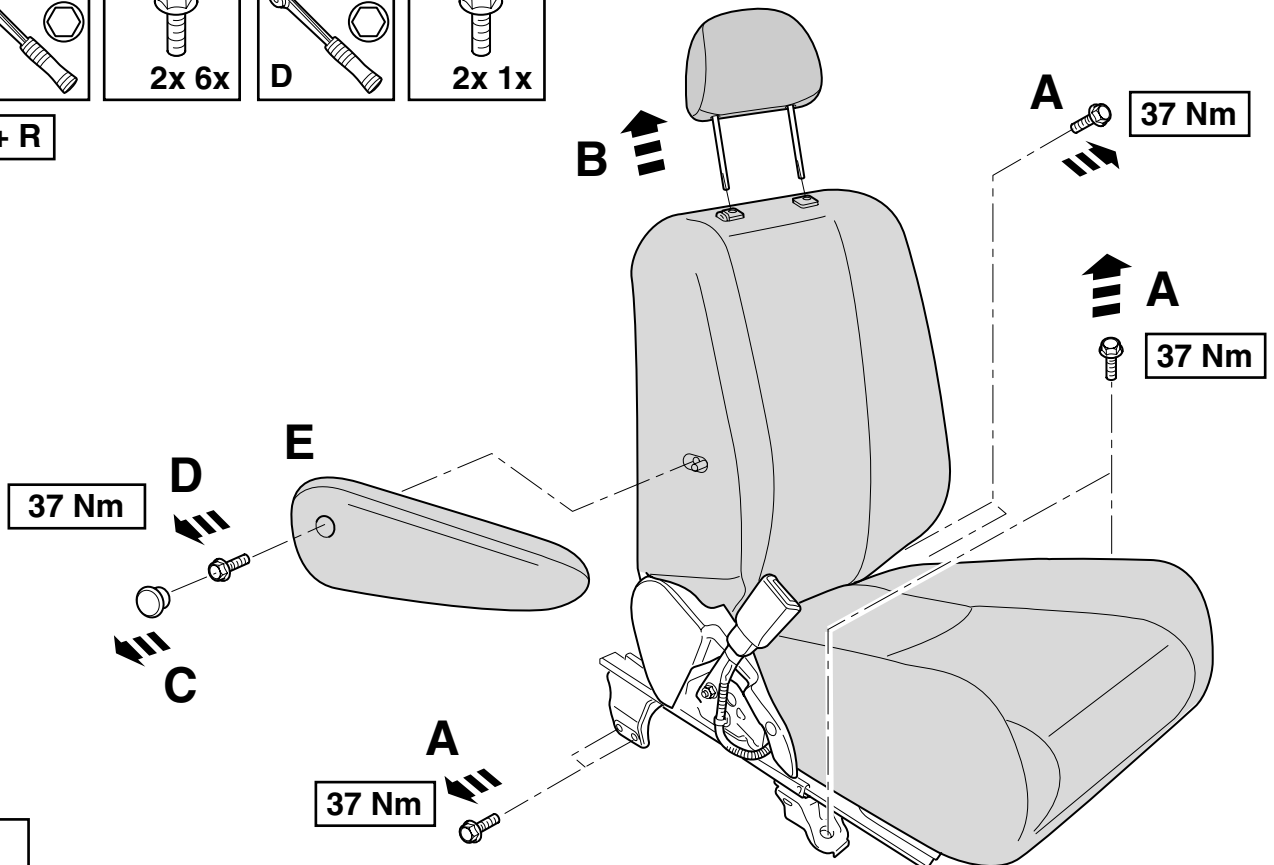

4

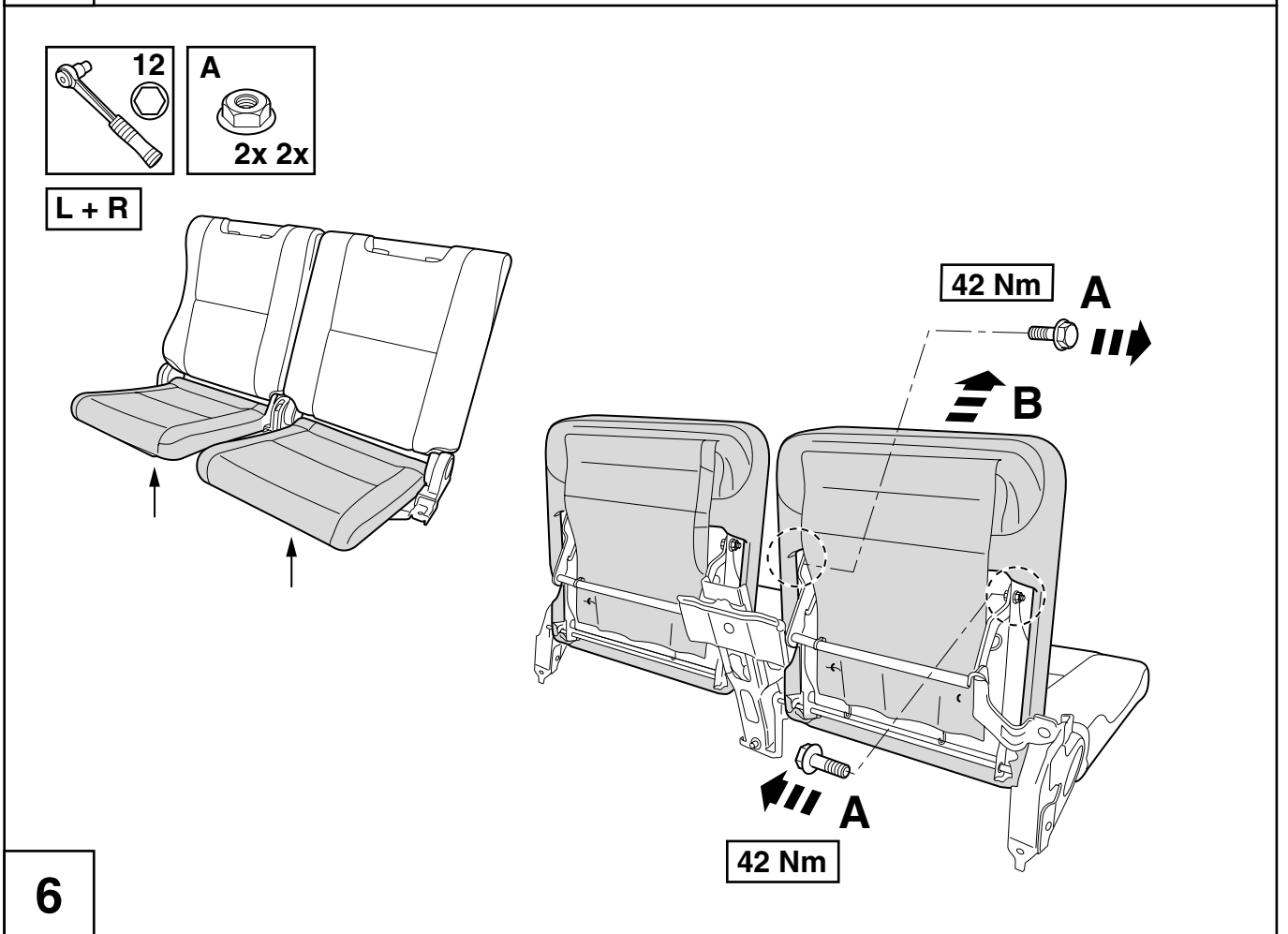
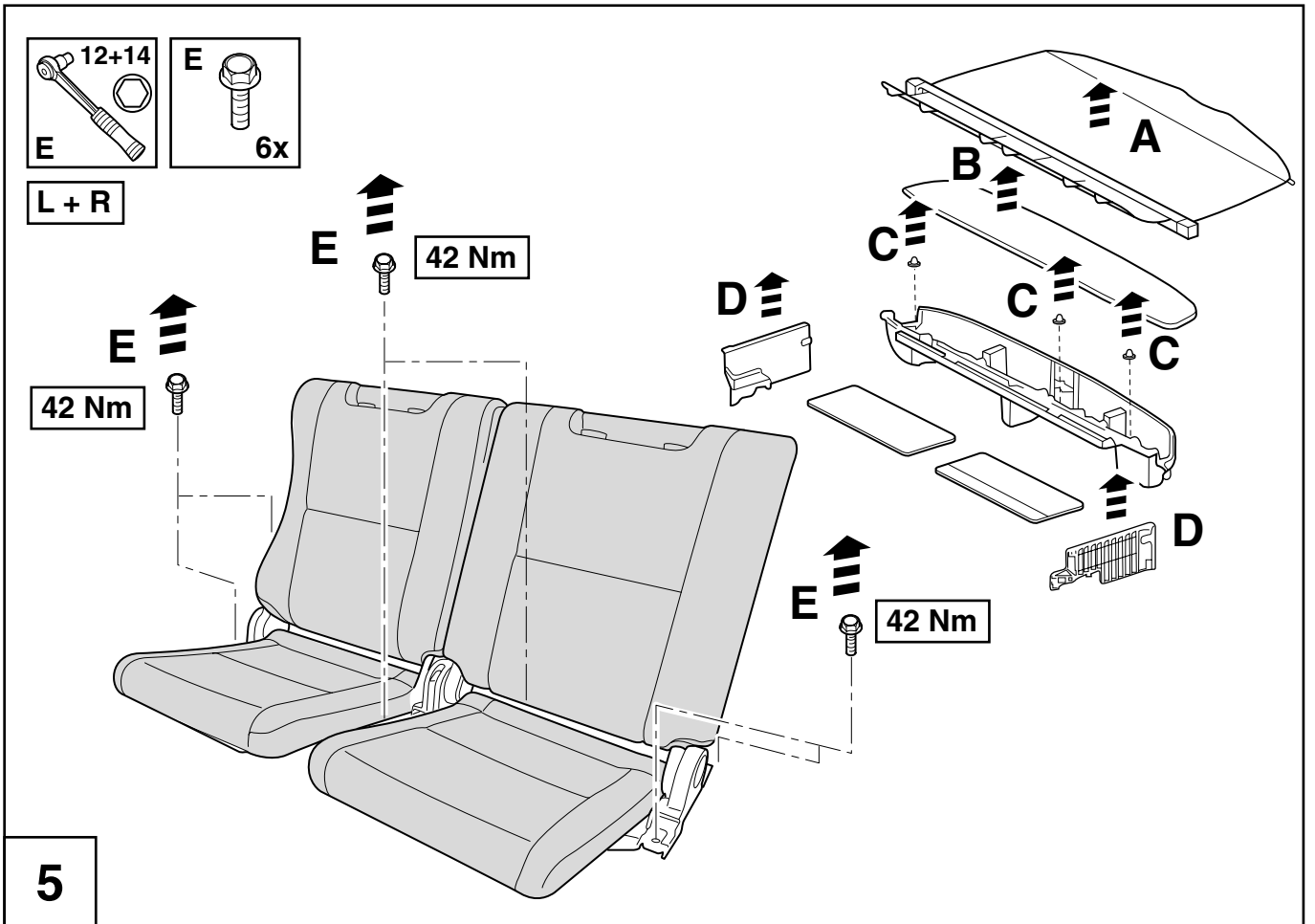

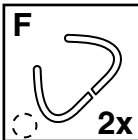
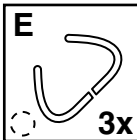
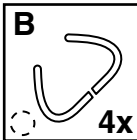
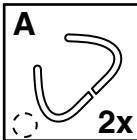
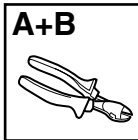

Rear L + R

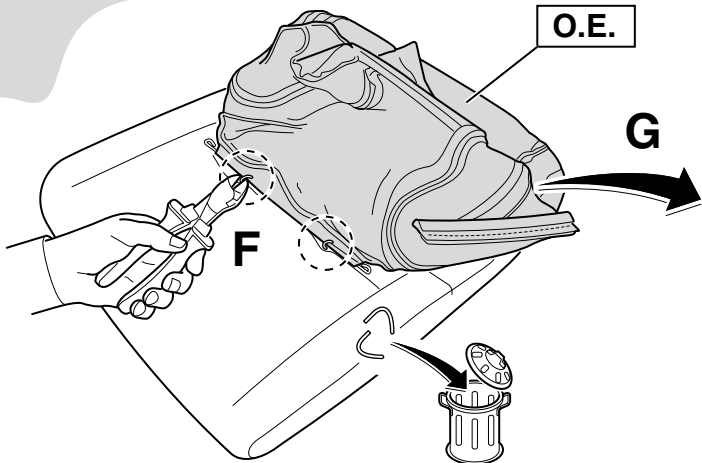
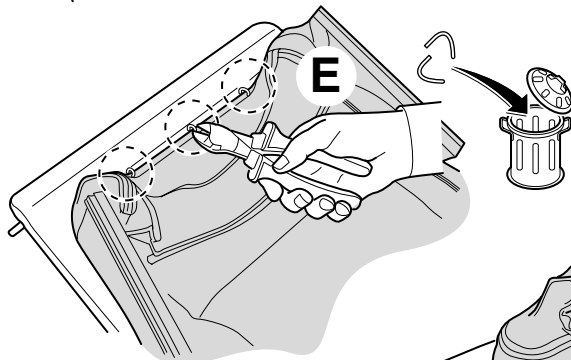
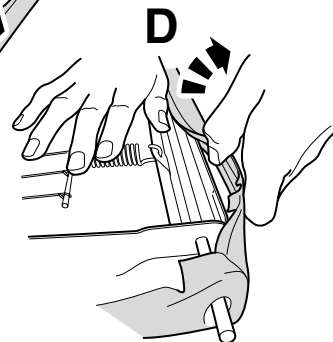
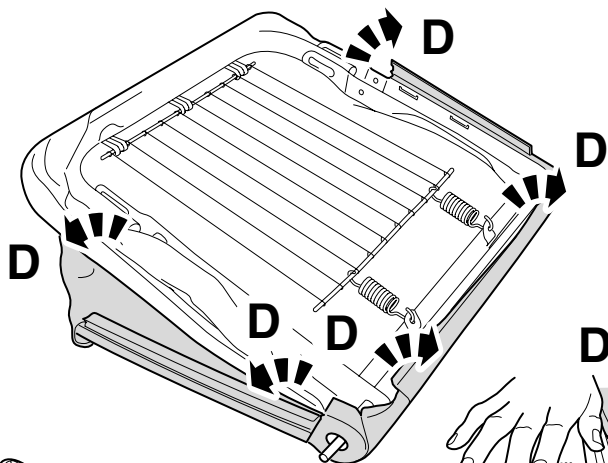
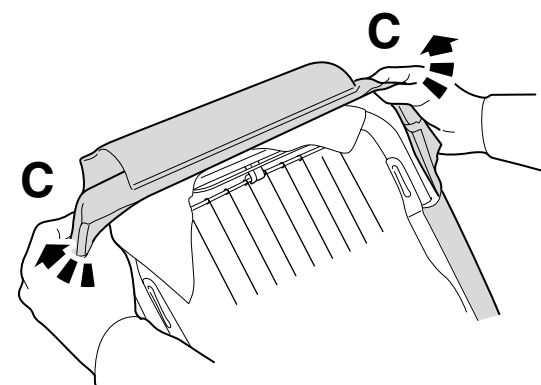
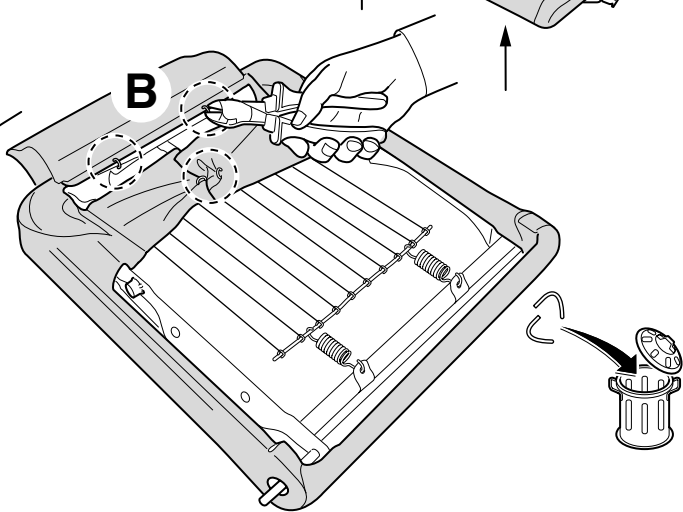
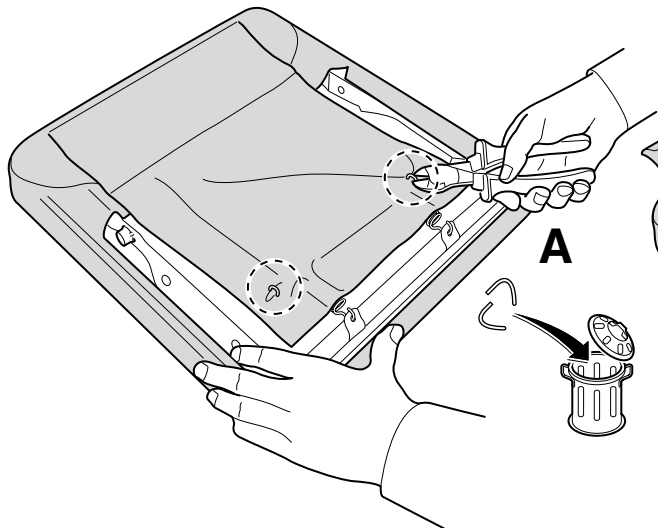
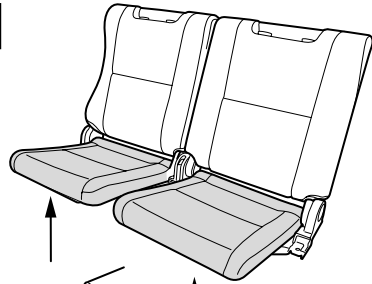

7

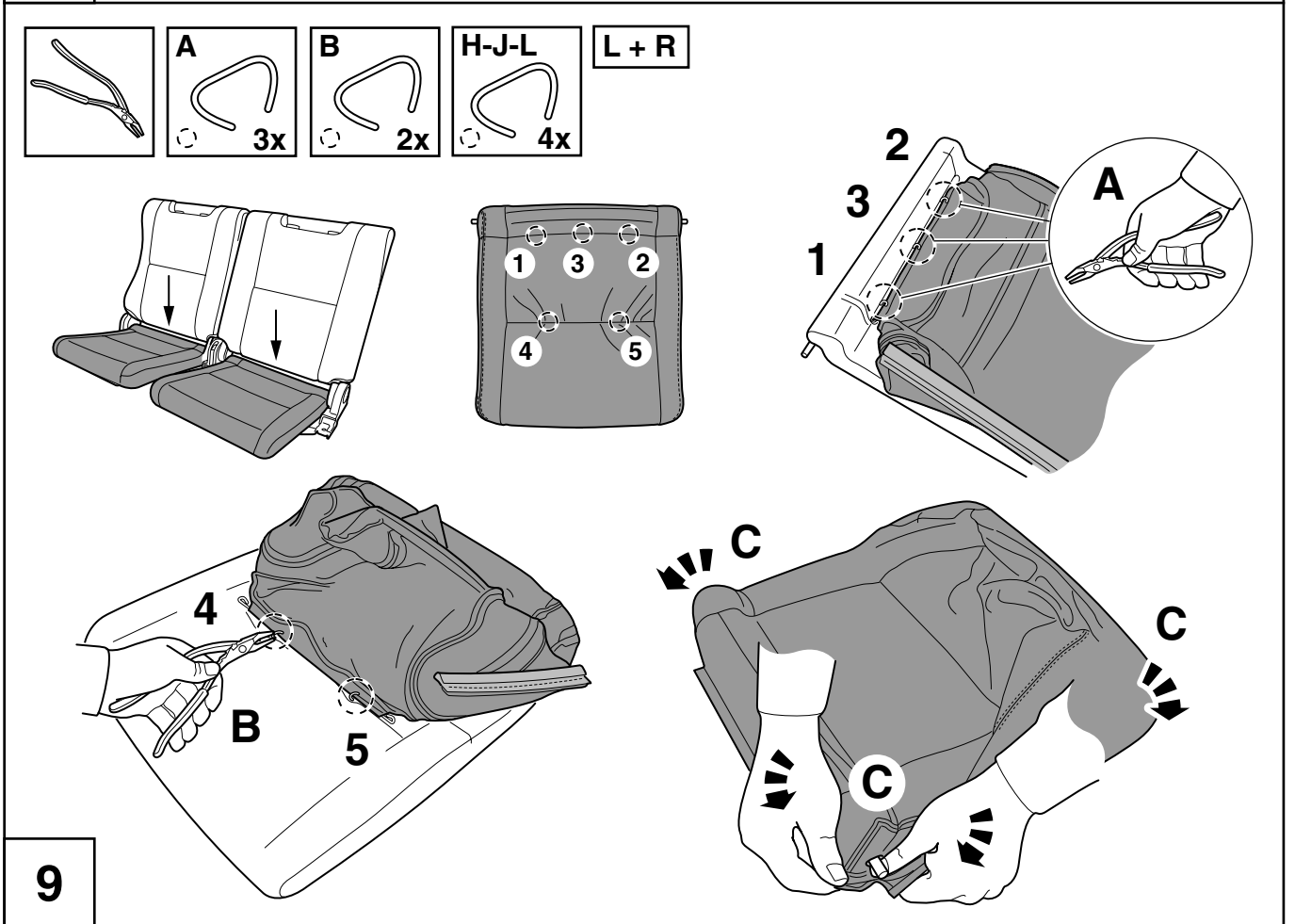
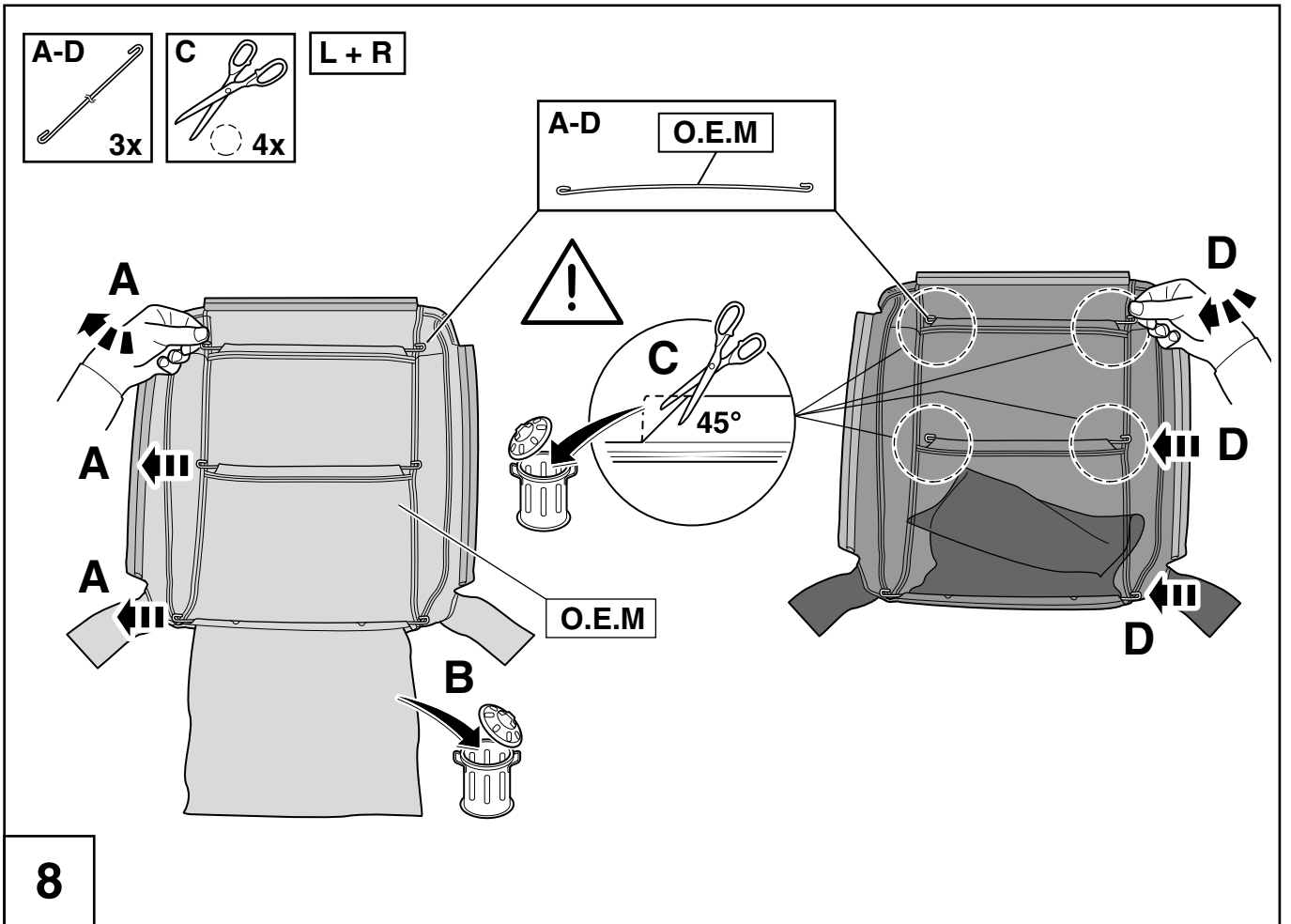

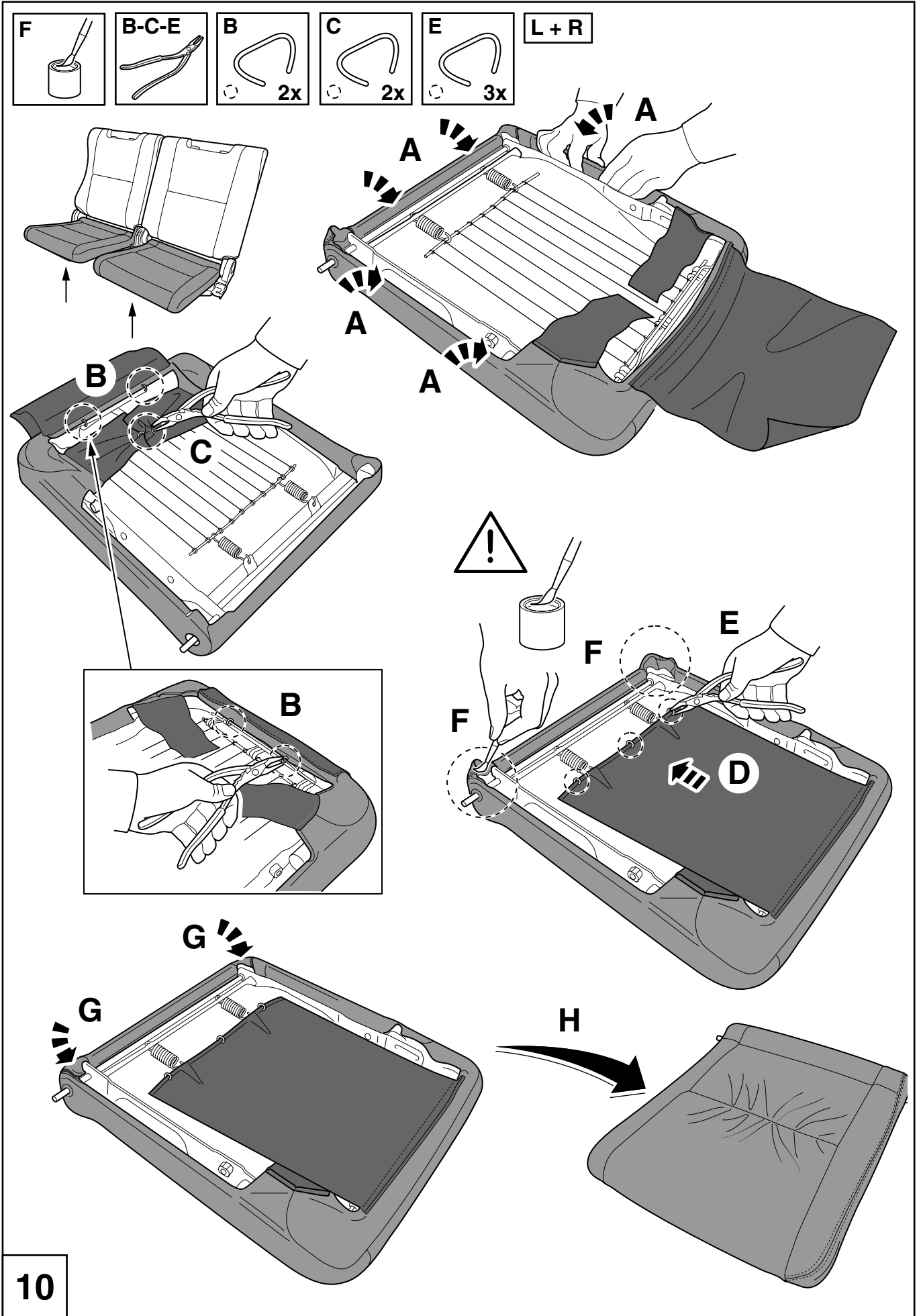

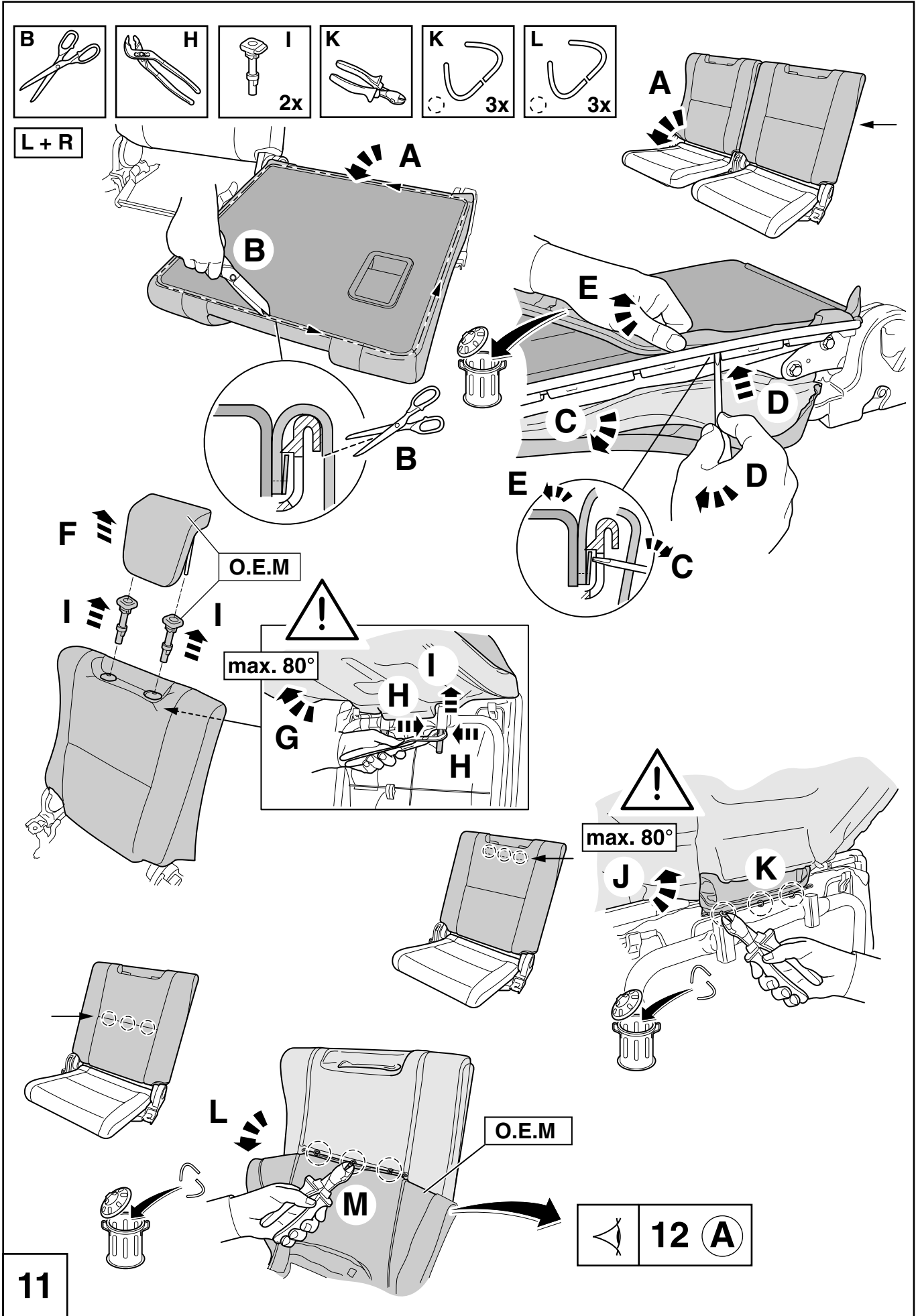

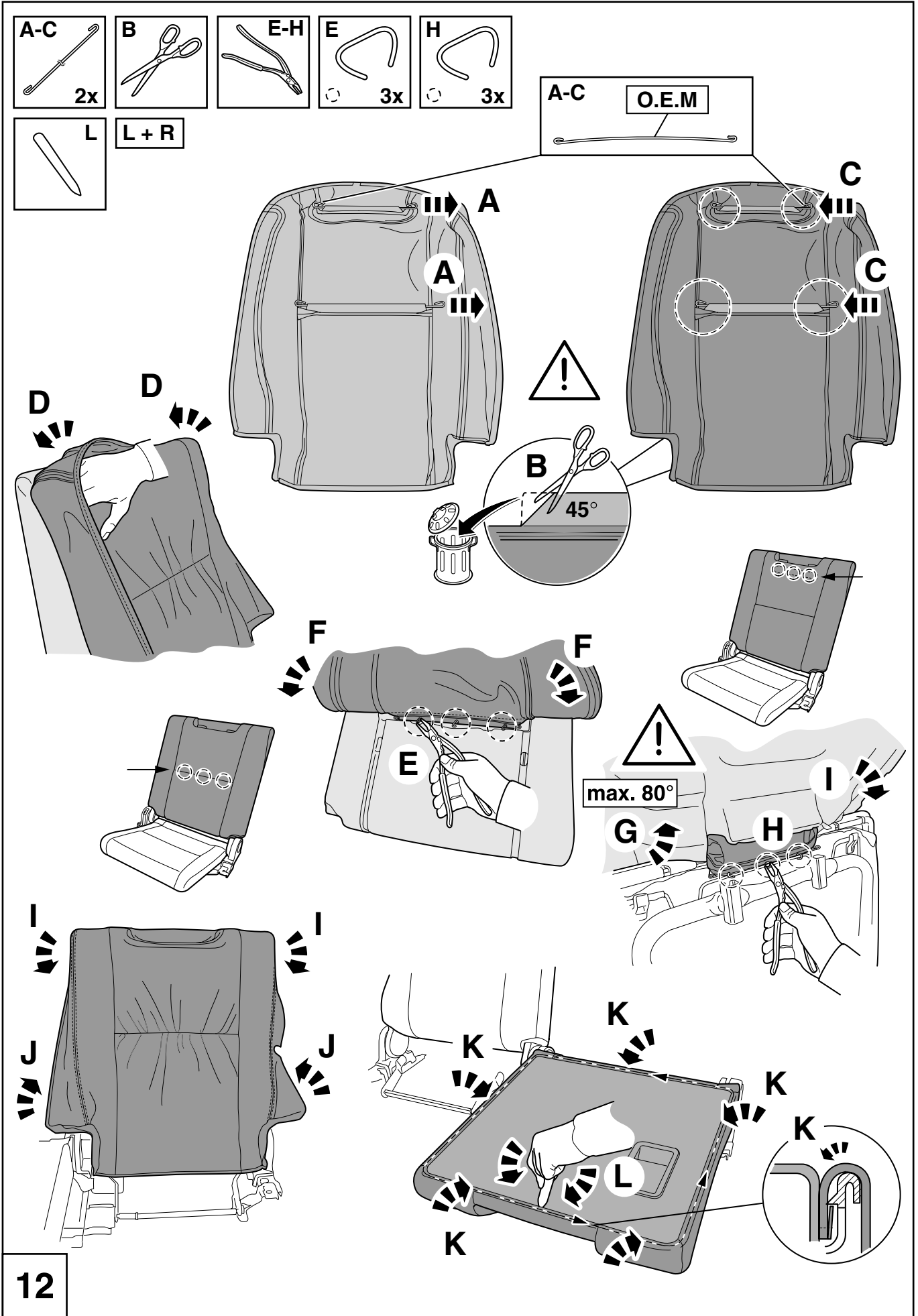

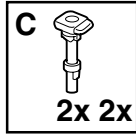
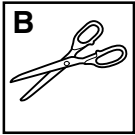
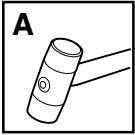

L + R

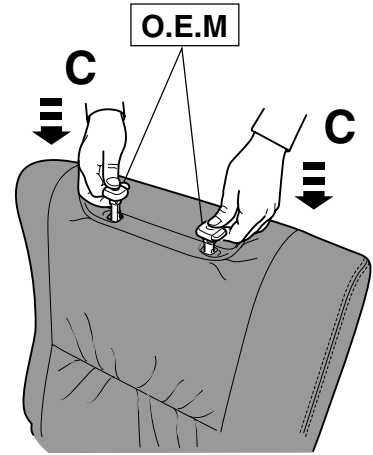
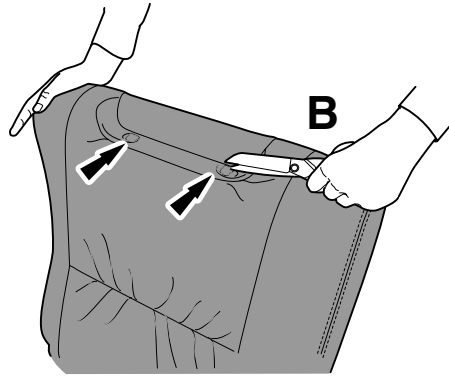
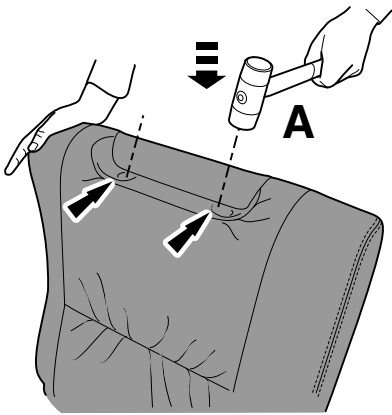
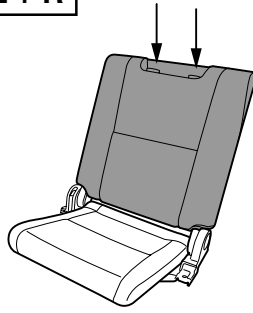

13

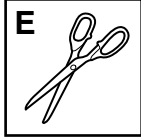
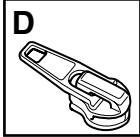
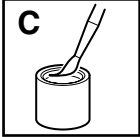

L + R

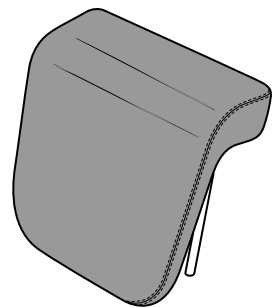
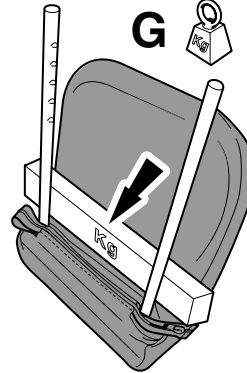
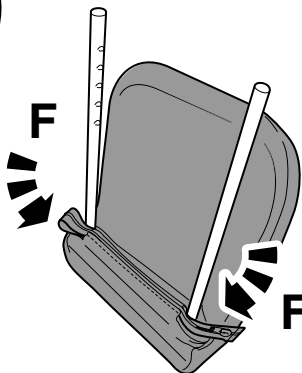
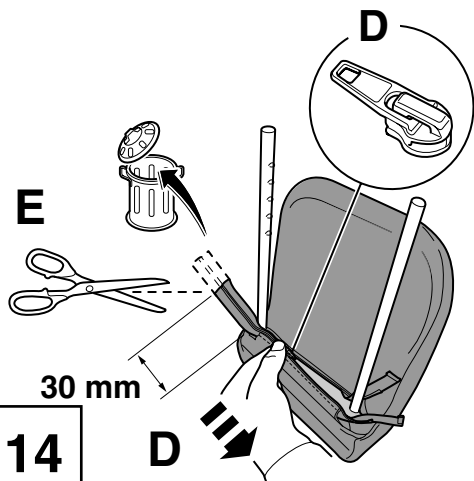
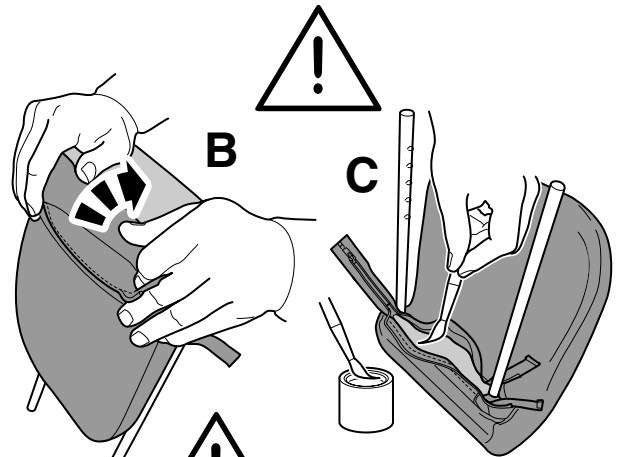
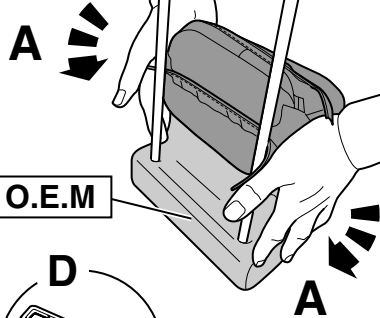
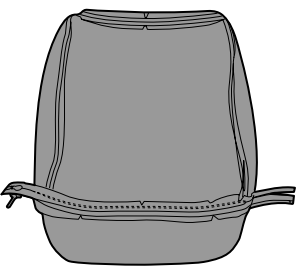

14

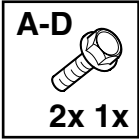

Middle CTR

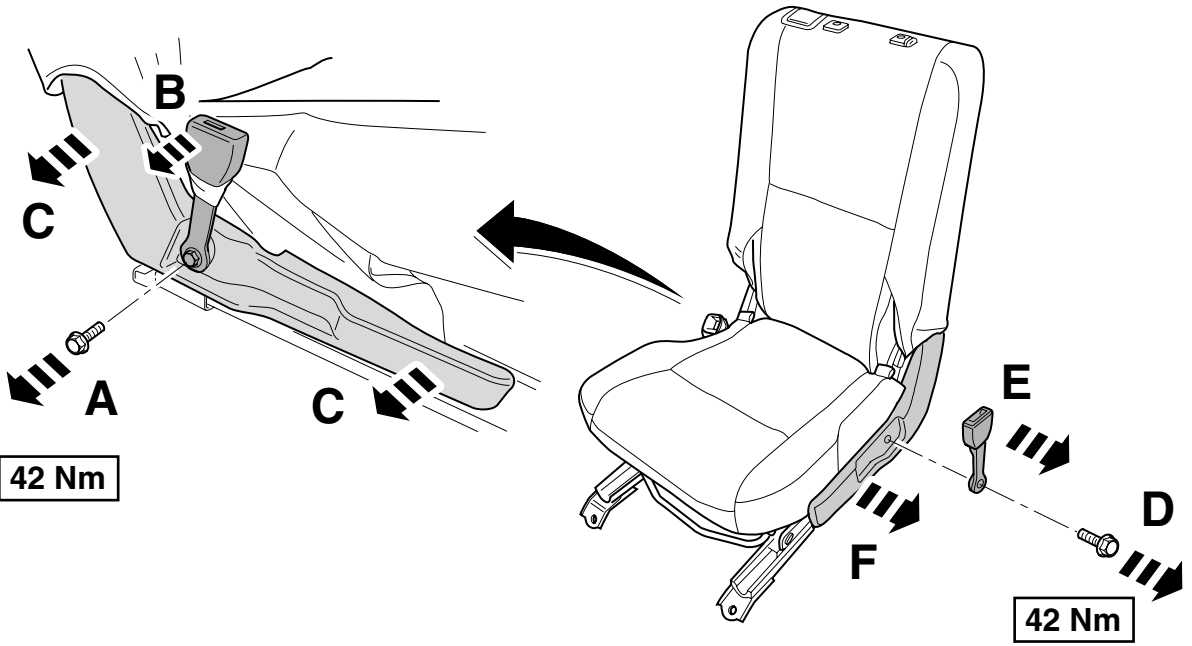

15a

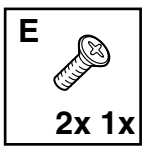
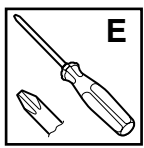
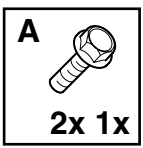
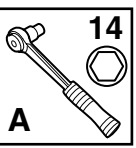

Middle L + R

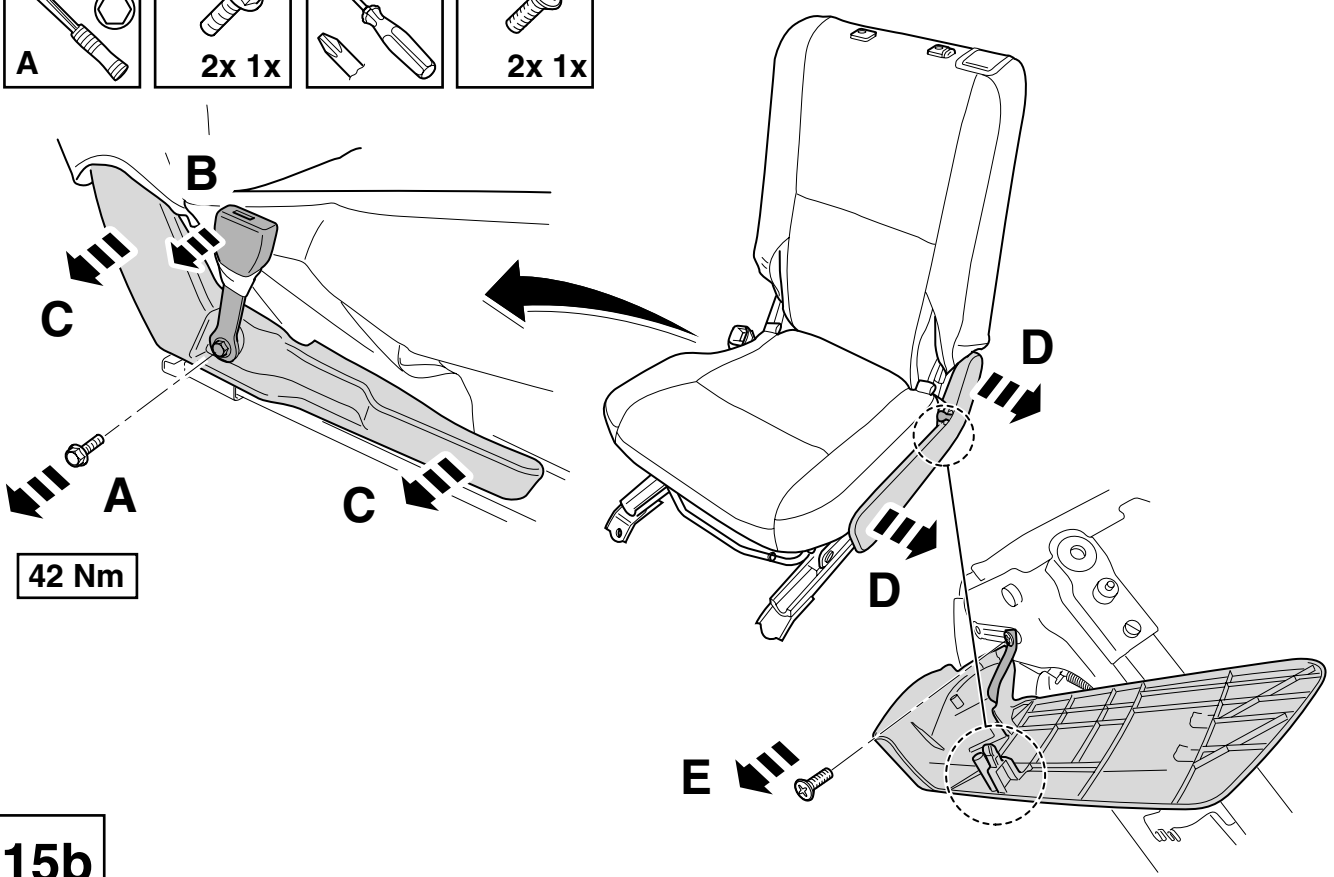

15b

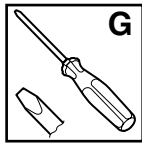
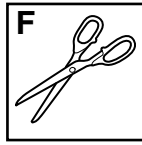
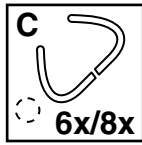
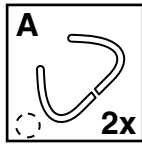
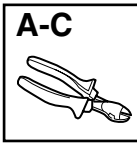

Middle L + R +
Middle central

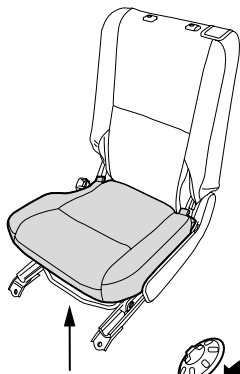

Middle L + R

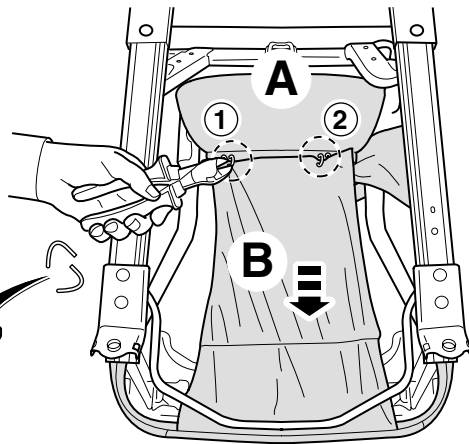

Middle central

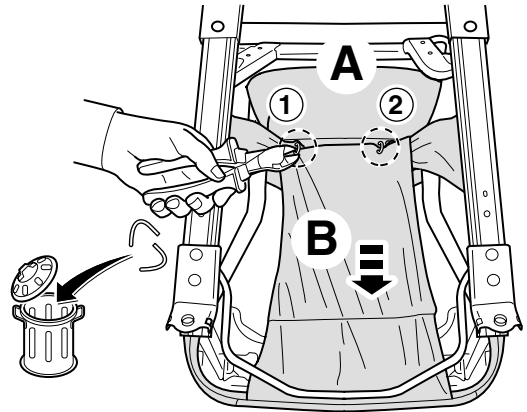

Middle L + R

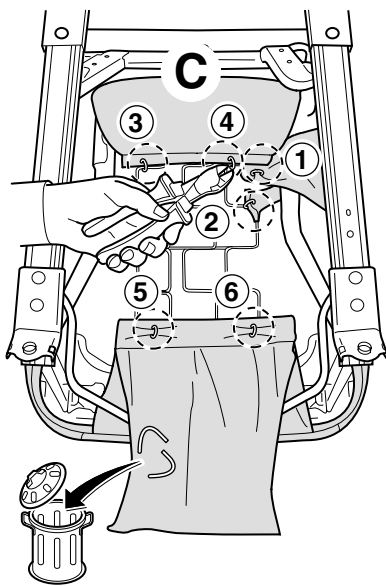

Middle central

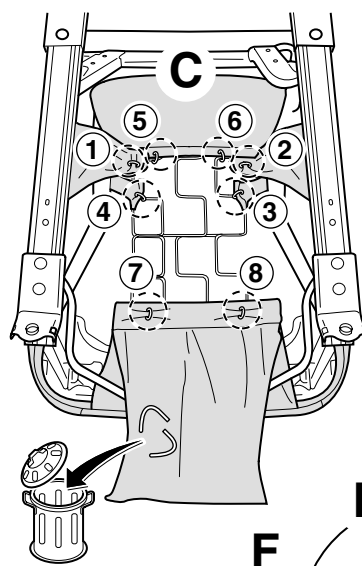

Middle L + R +
Middle central

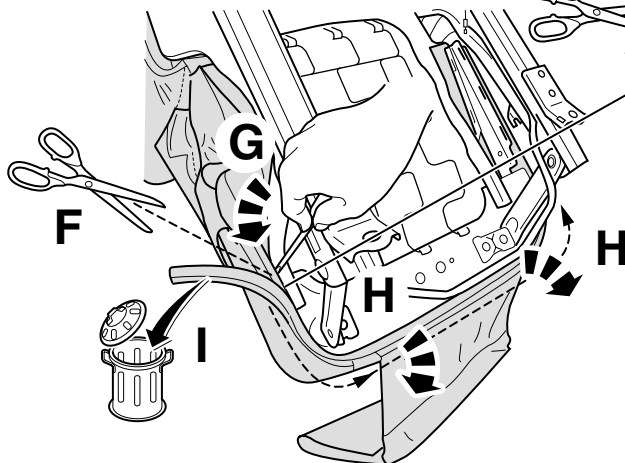
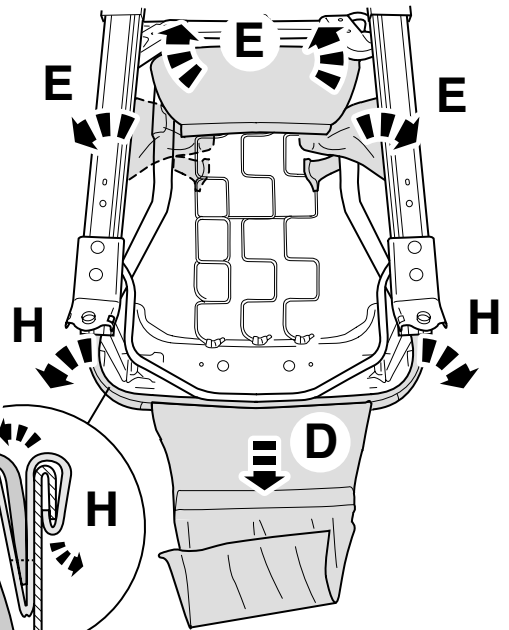

15c

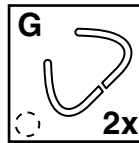
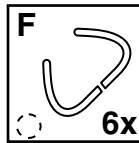
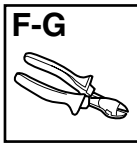
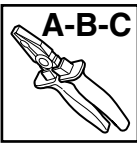

Middle L + R + CTR

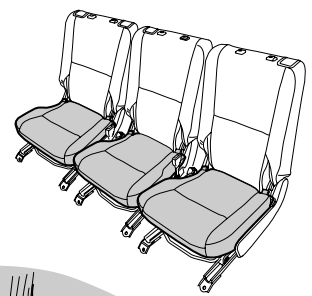

Middle central

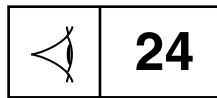
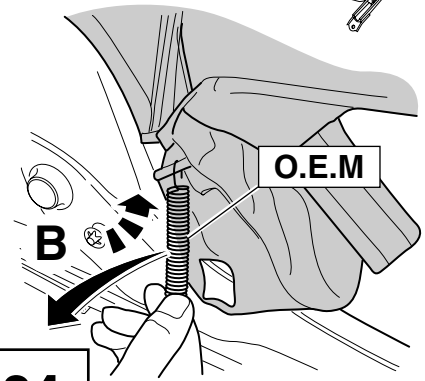
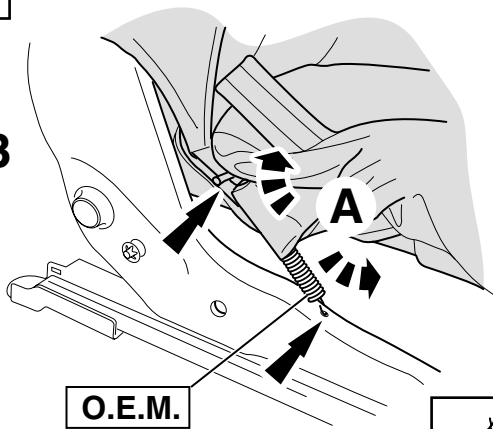
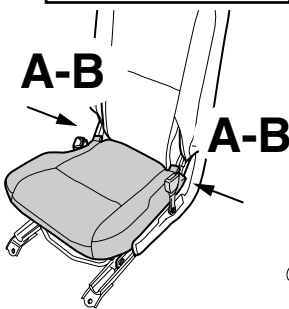

Middle L + R

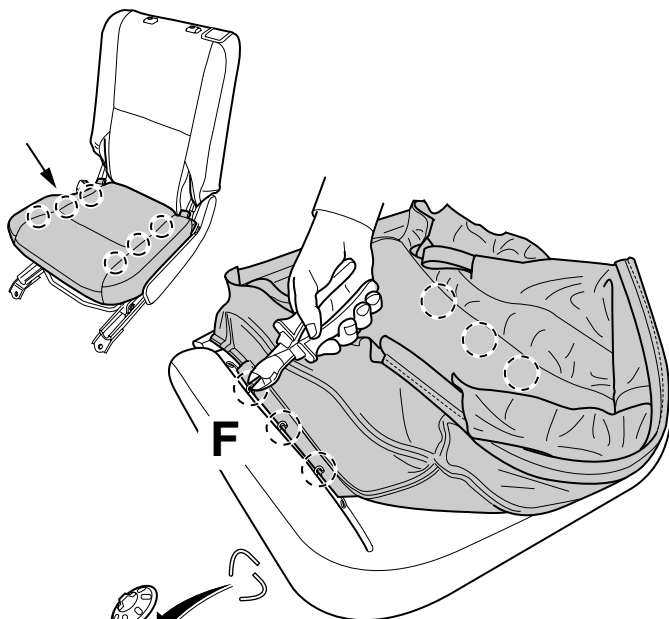
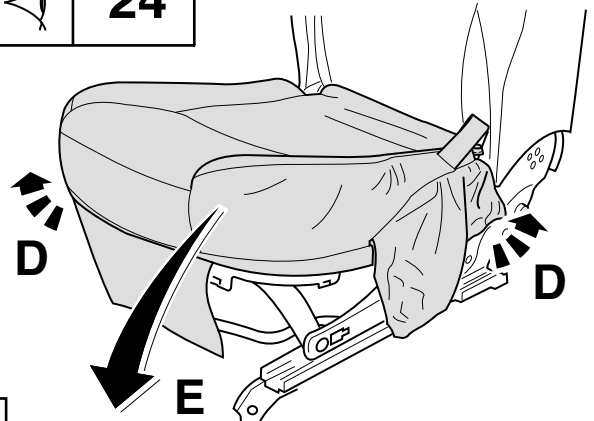
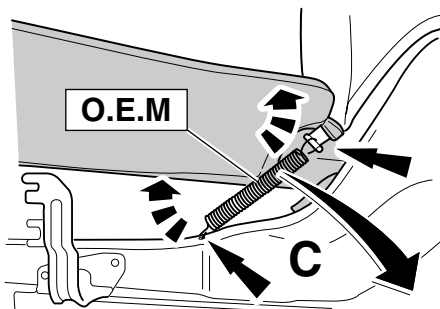
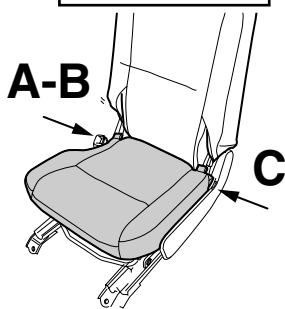

16

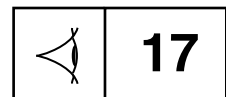
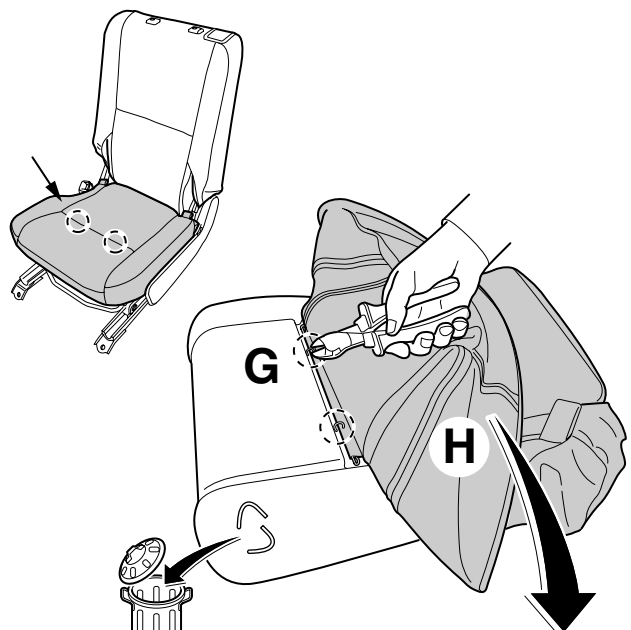

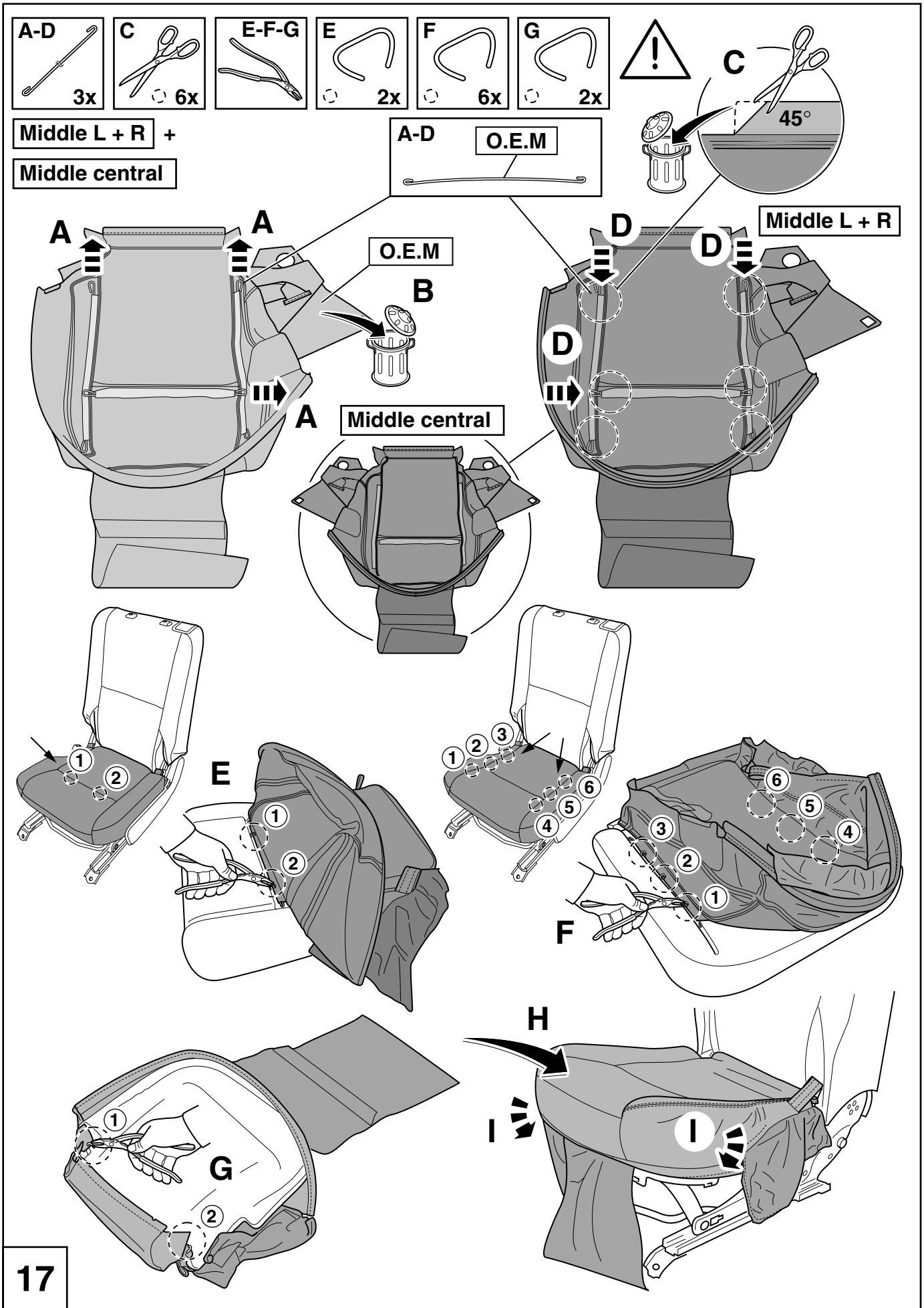

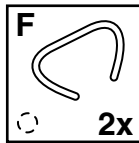
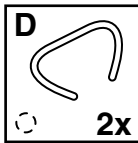
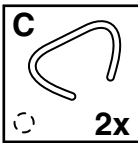
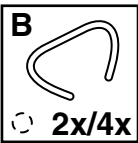
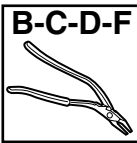

Middle L + R +

Middle central

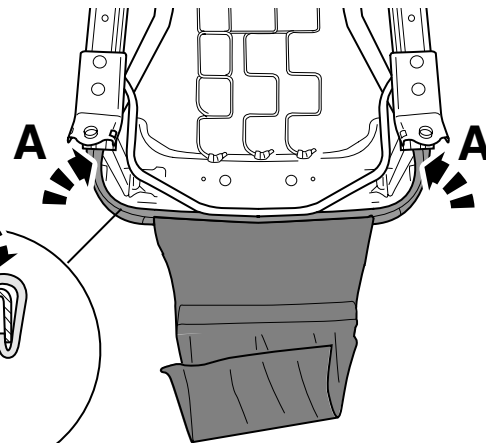
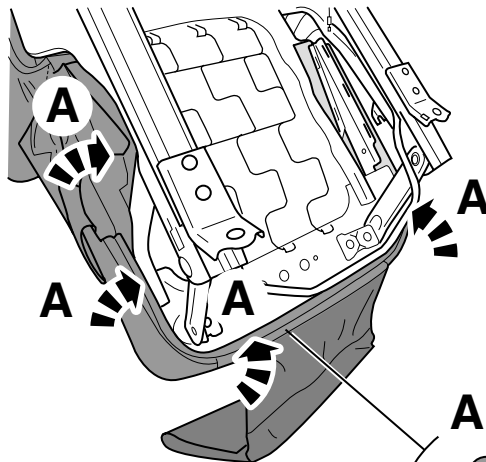
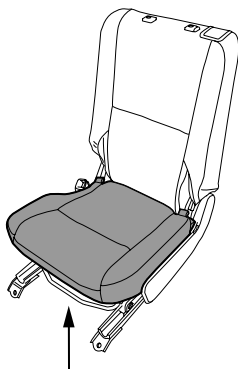

Middle L + R

B = 2x 1x

C = 1x 2x

D = 1x 2x

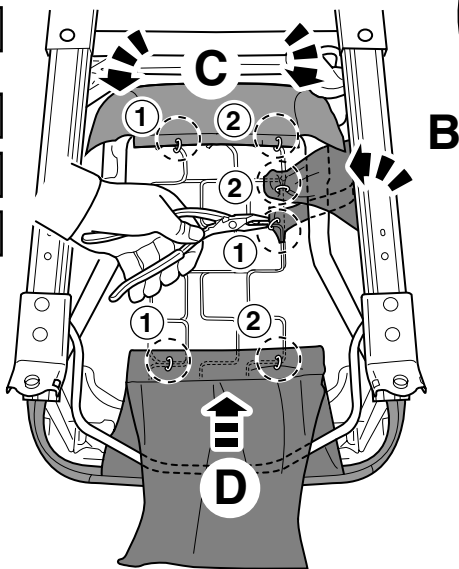

Middle L + R + CTR

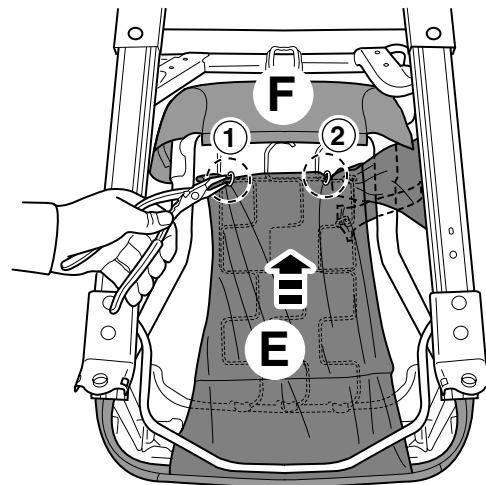

Middle central

B = 4x 1x

C = 1x 2x

D = 1x 2x

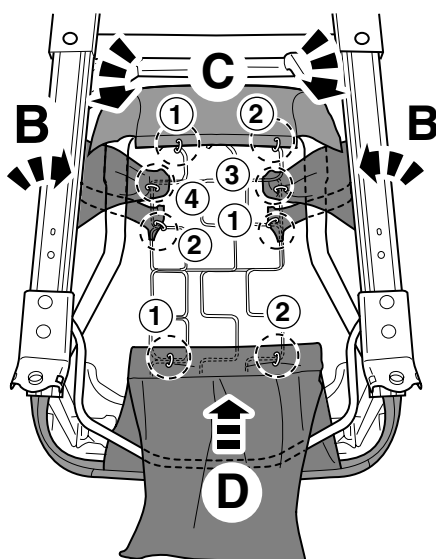

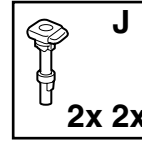
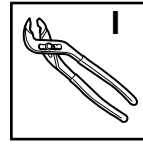
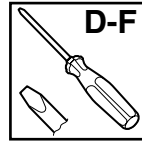
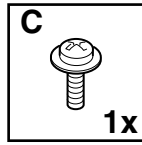
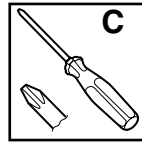
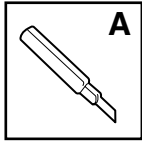
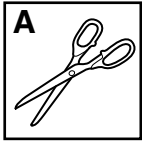

Middle L + R + CTR

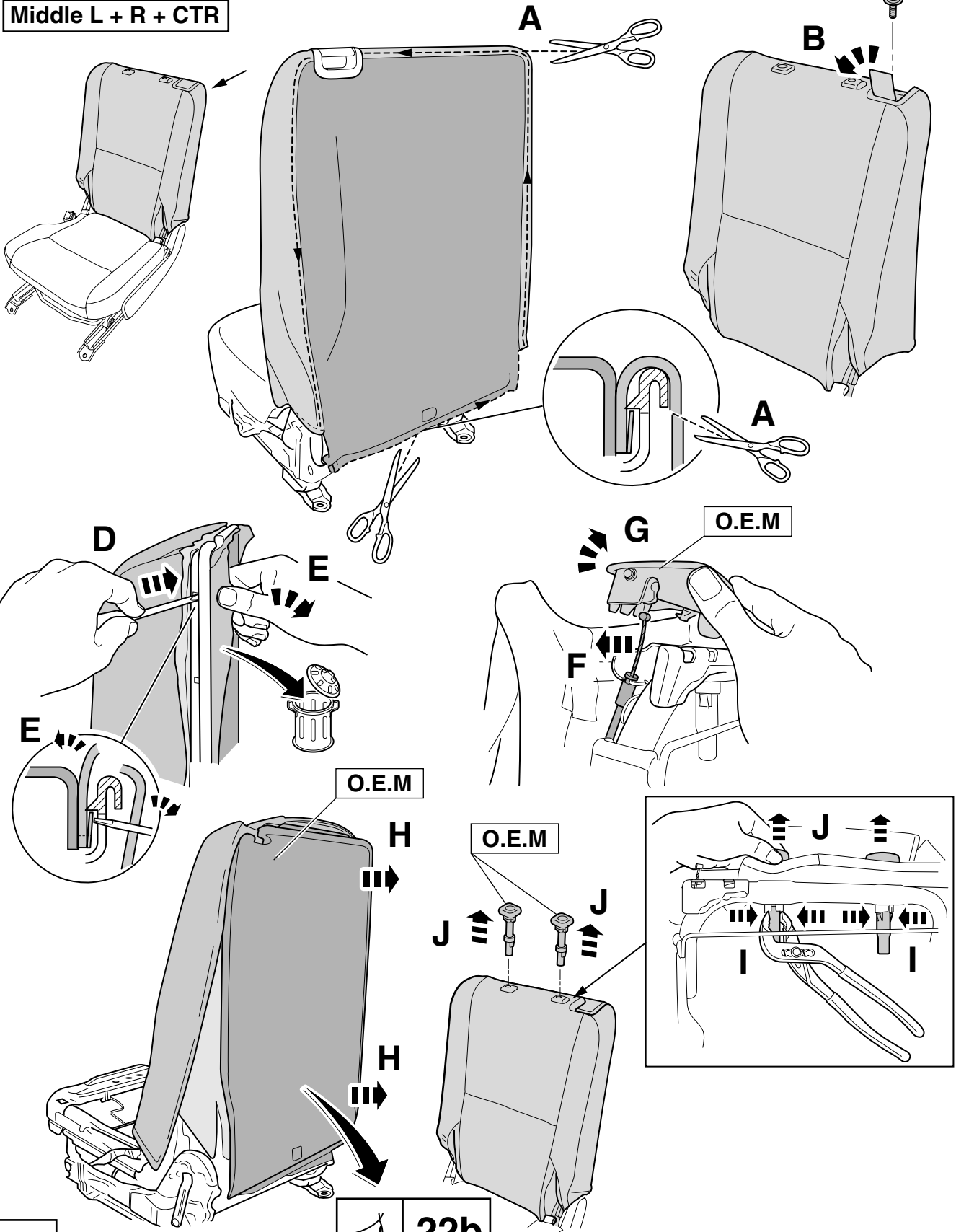

19

22b

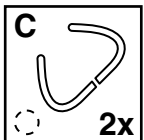
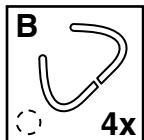
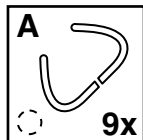
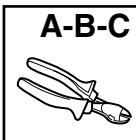

Middle L + R + CTR

L + R

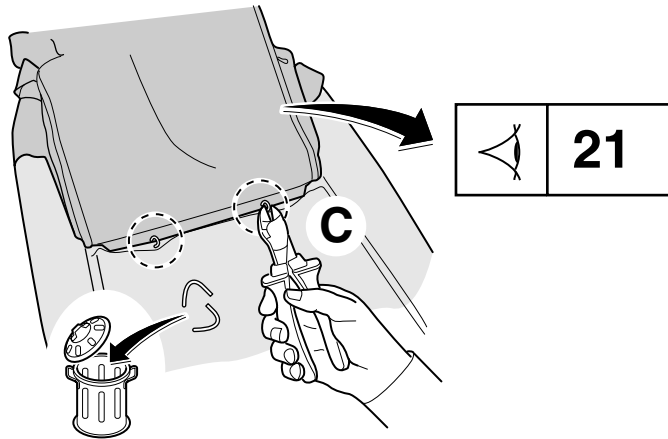
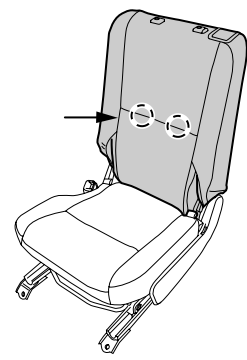
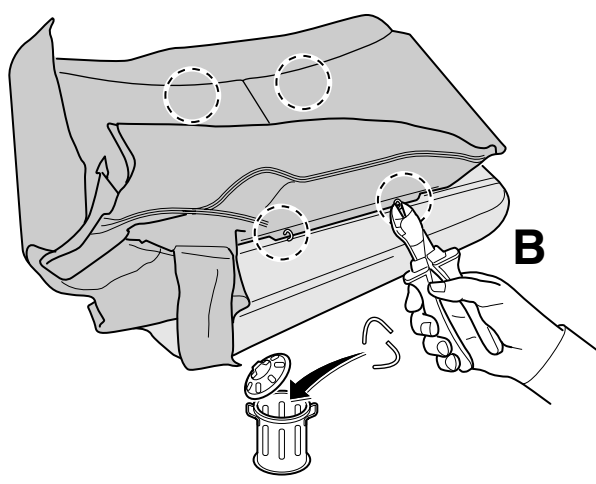
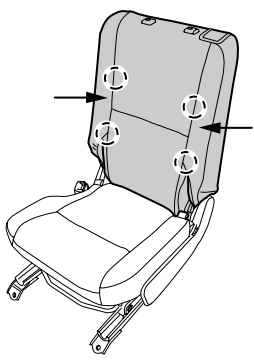
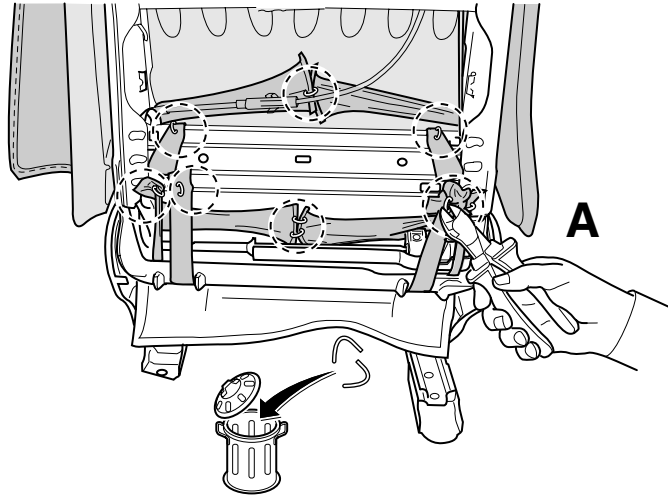
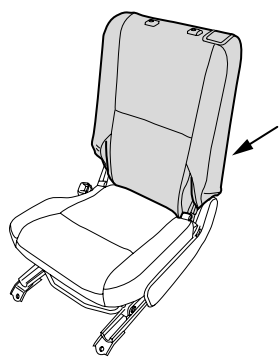

20

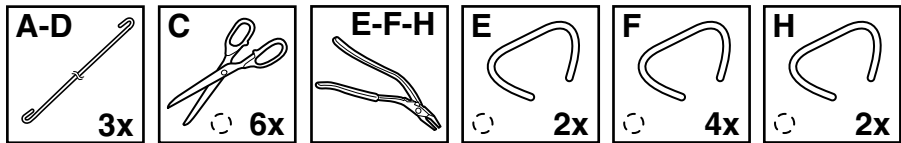

Middle L + R + CTR

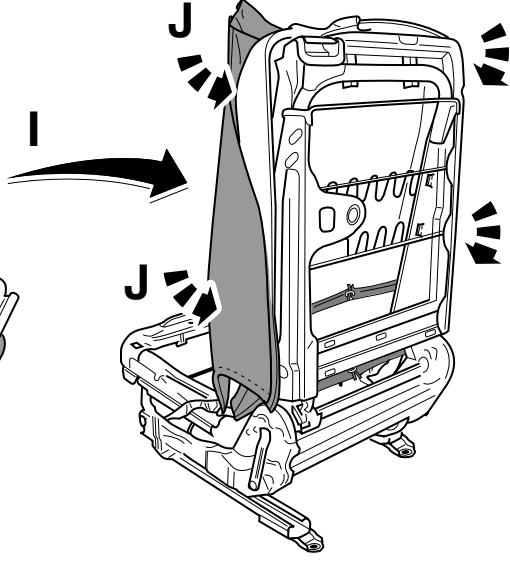
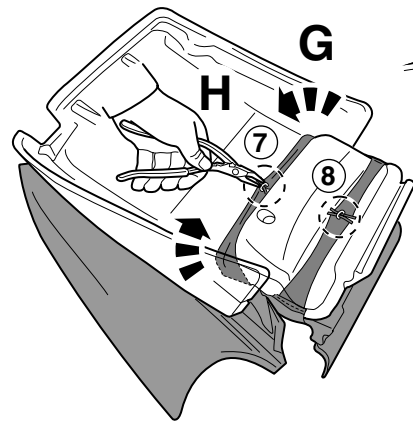
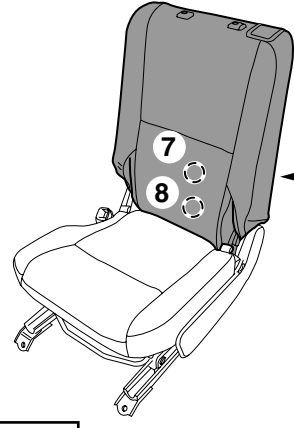
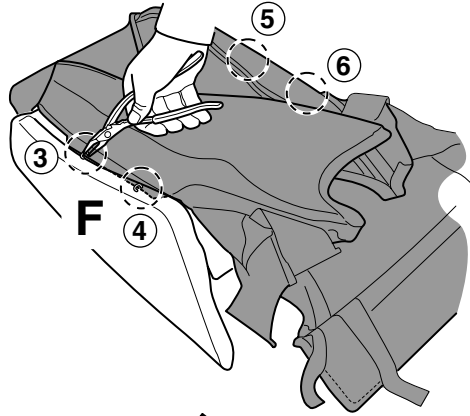
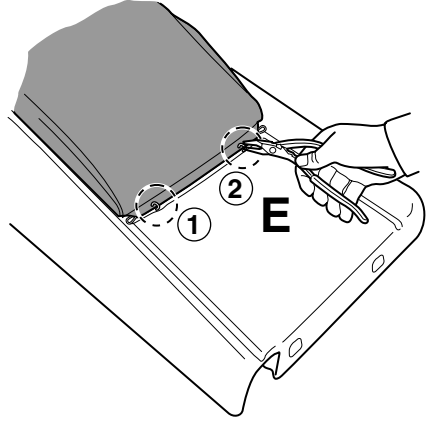
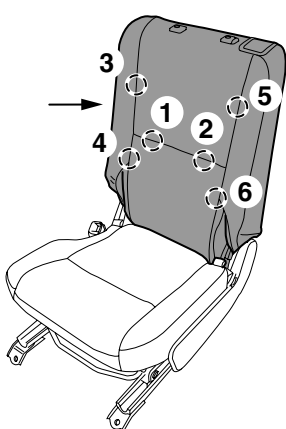
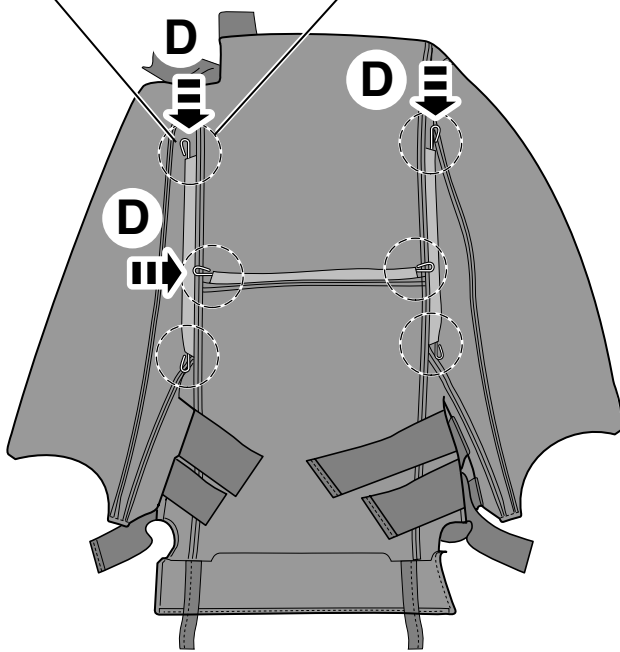
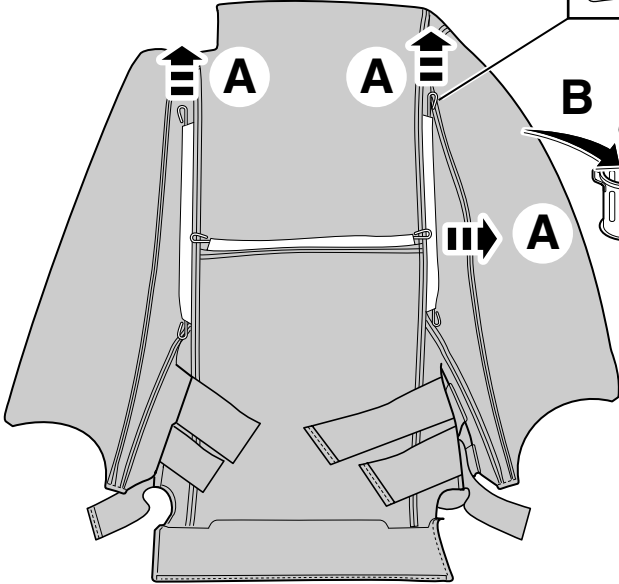
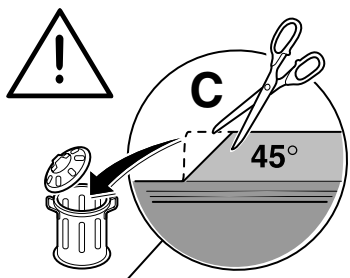

21

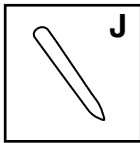
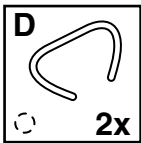
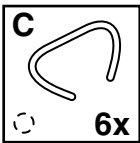
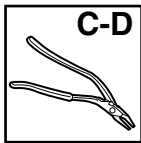

Middle L + R + CTR

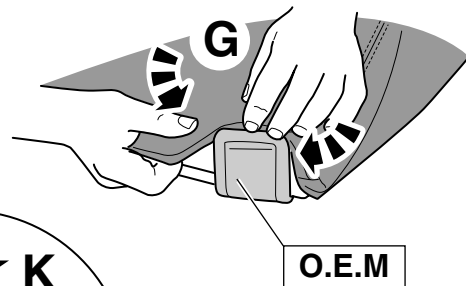
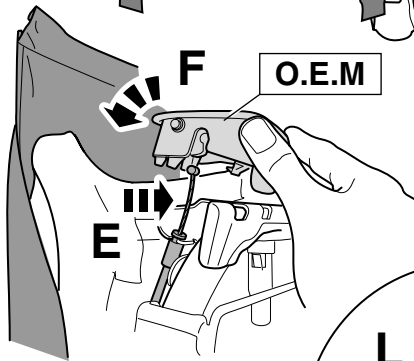
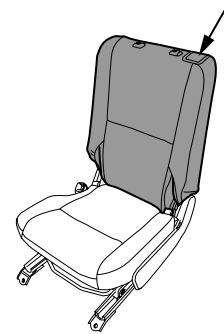
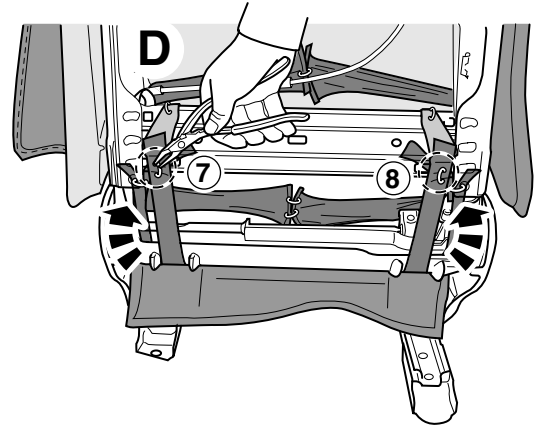
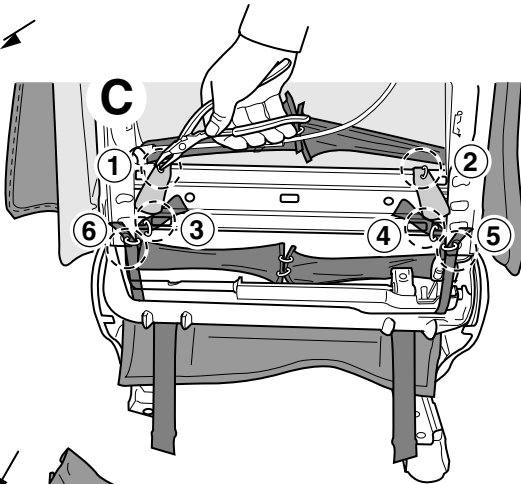
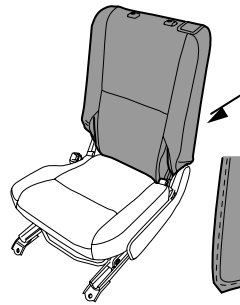
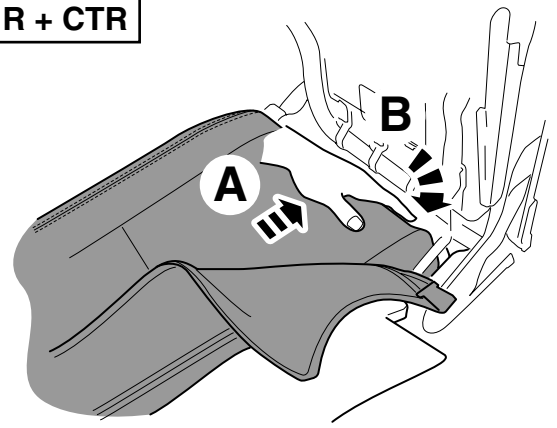
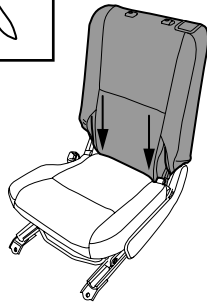
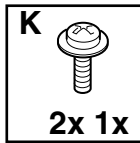
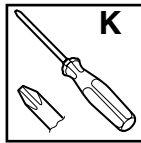

O.E.M.

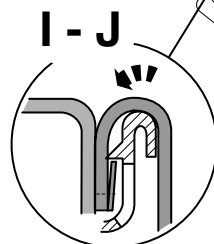
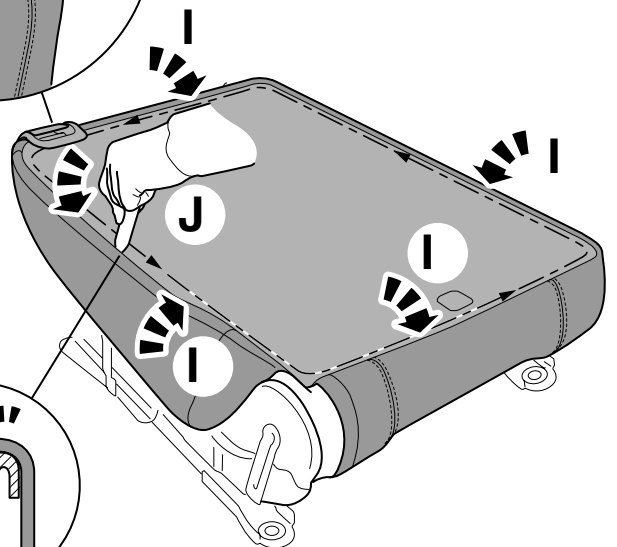
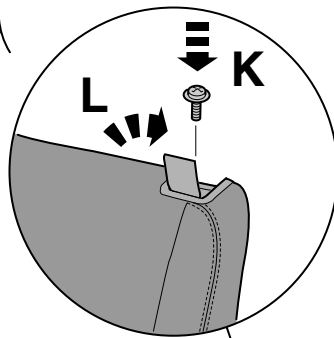
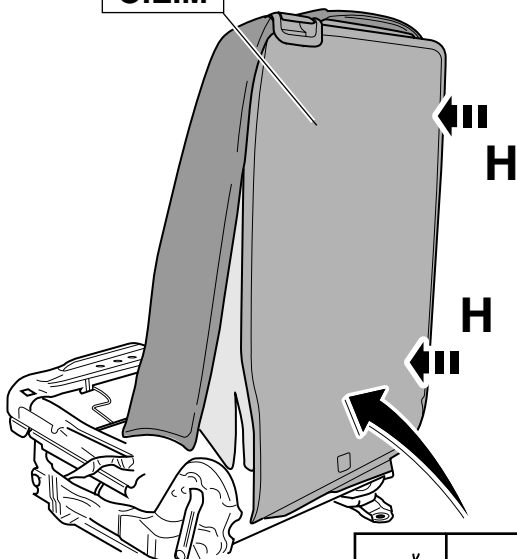

22a



C-D-E-F

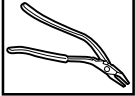

F

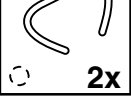

2x

Middle L + R + CTR

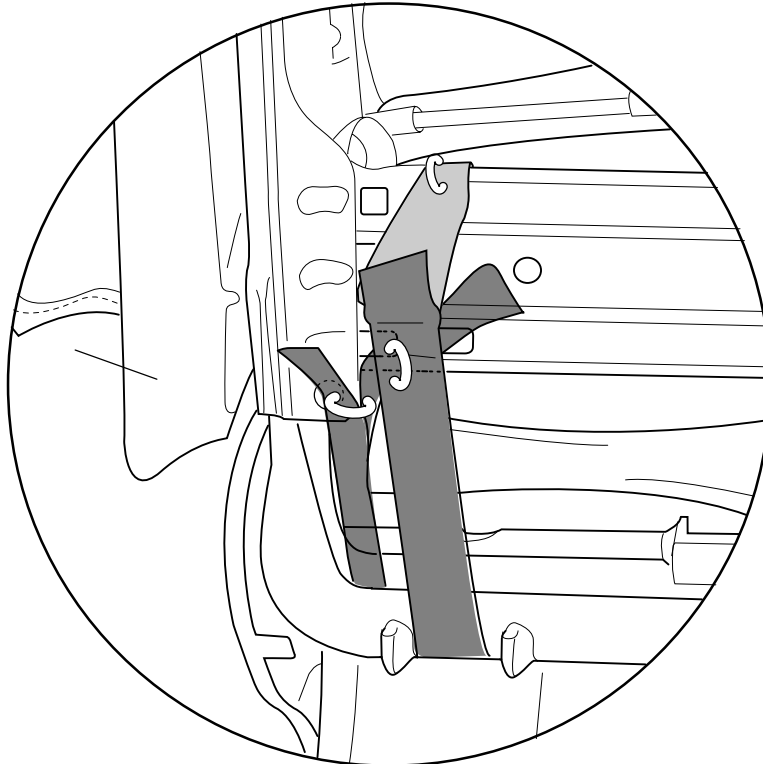
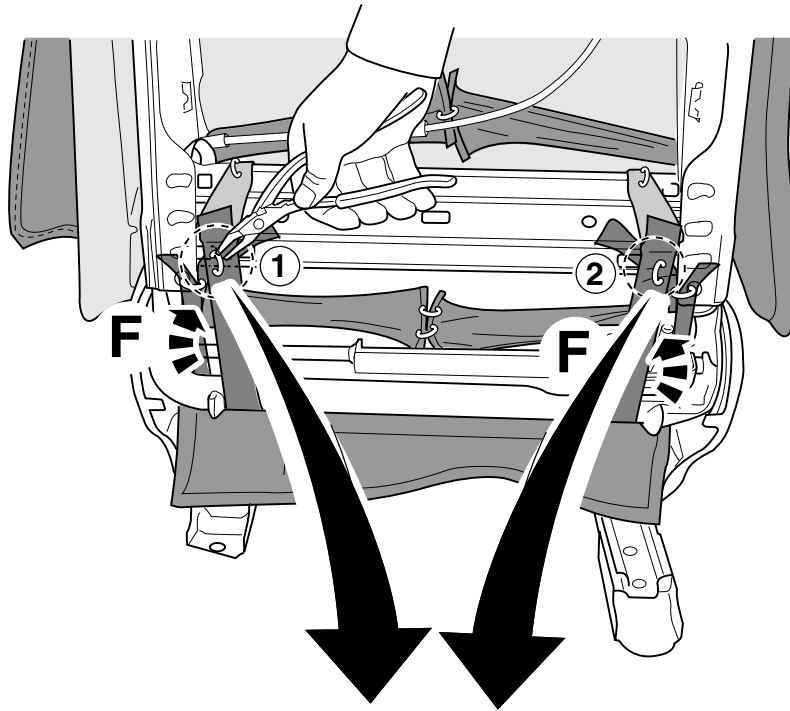

22b

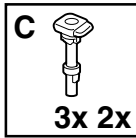
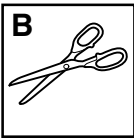
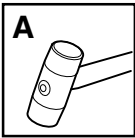

Middle L + R +
Middle Central

3x 2x

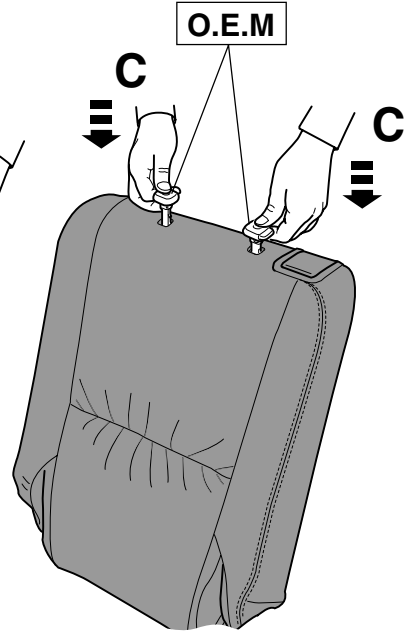
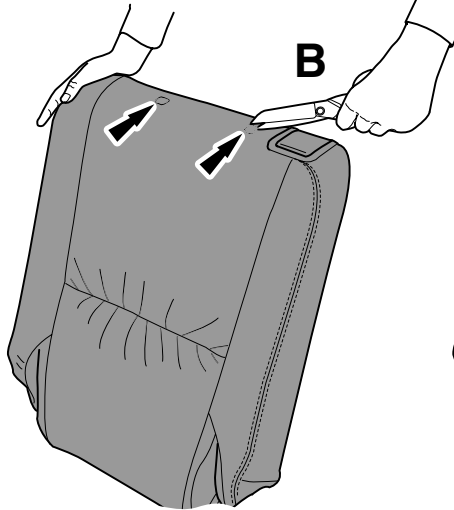
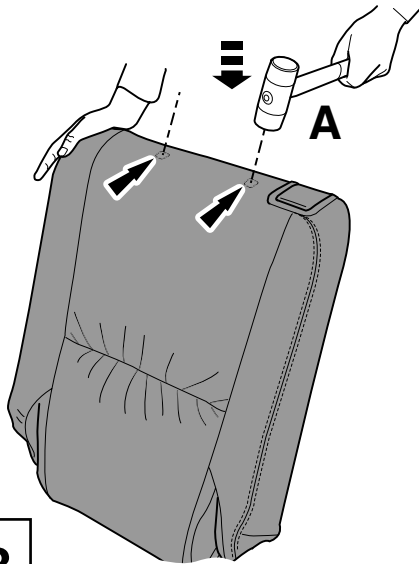
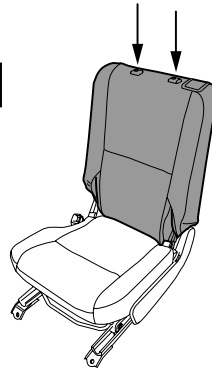

23

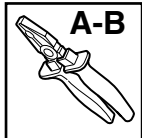

Middle L + R + Middle Central

Middle central

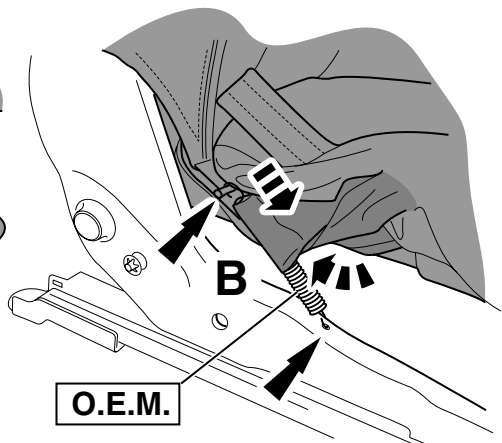
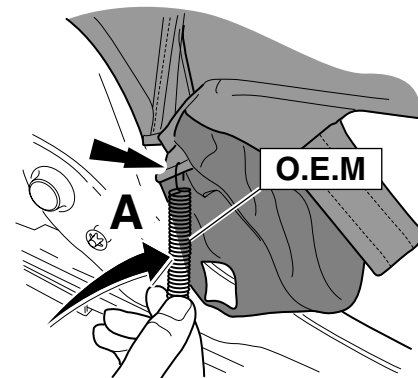
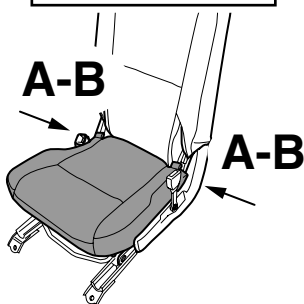

Middle L + R

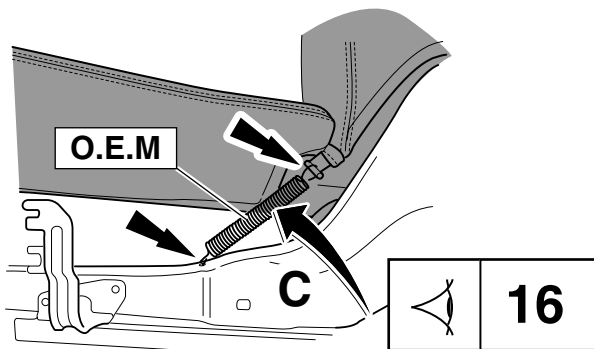
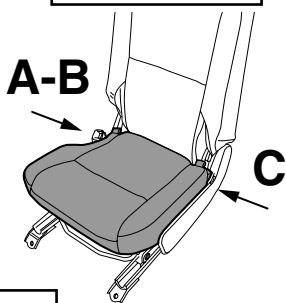

24

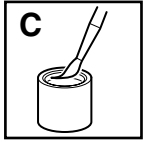
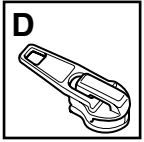

Middle Central + Rear 2nd row

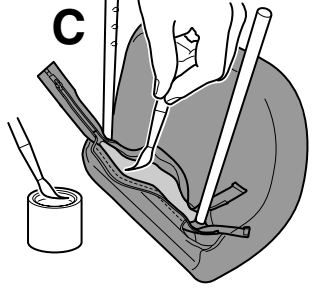
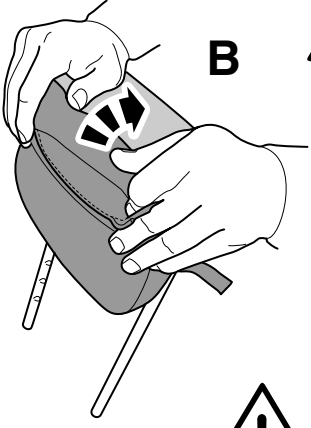
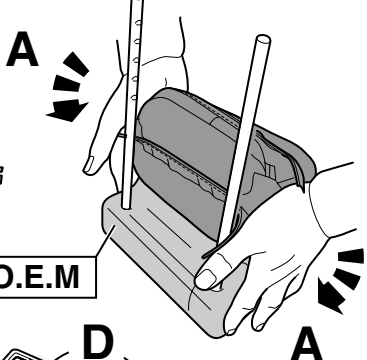
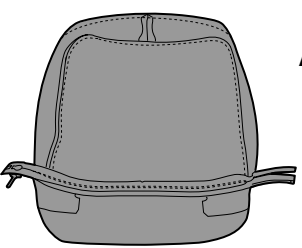

O.E.M

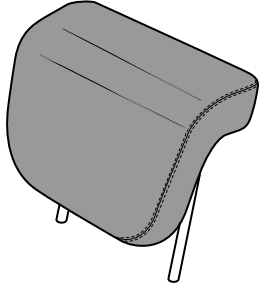
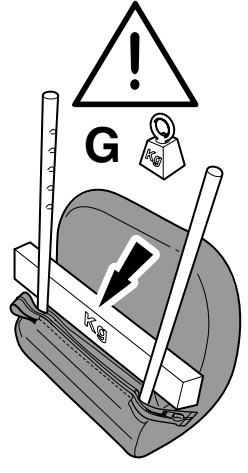
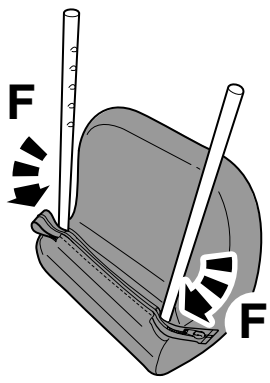
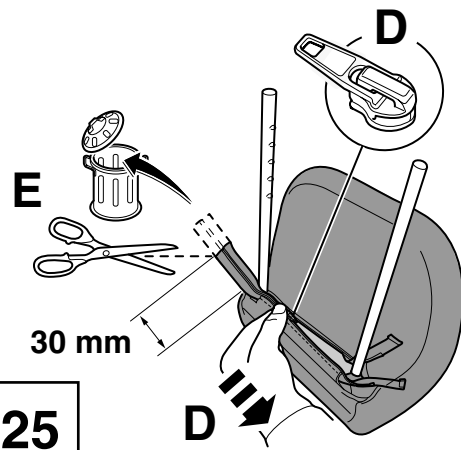

25

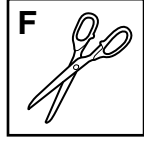
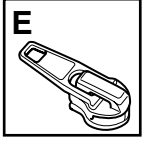
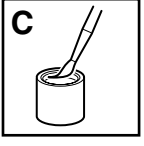

Middle L + R

Front L + R

L + R

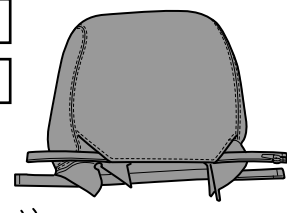
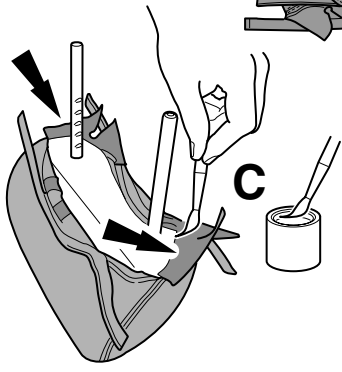
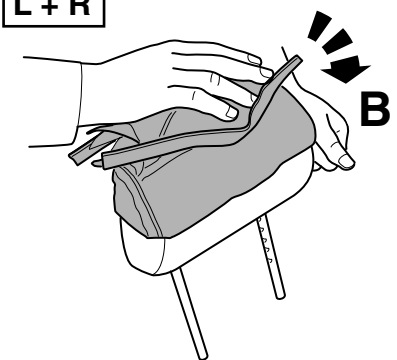

O.E.M

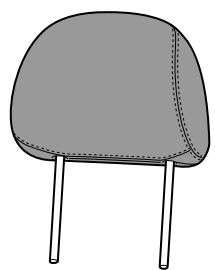
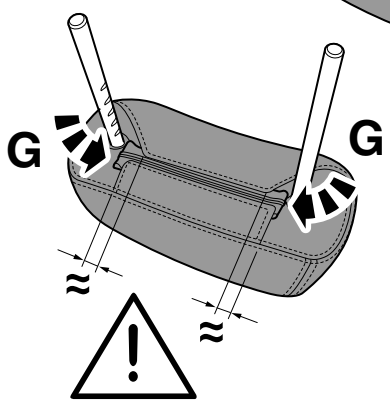
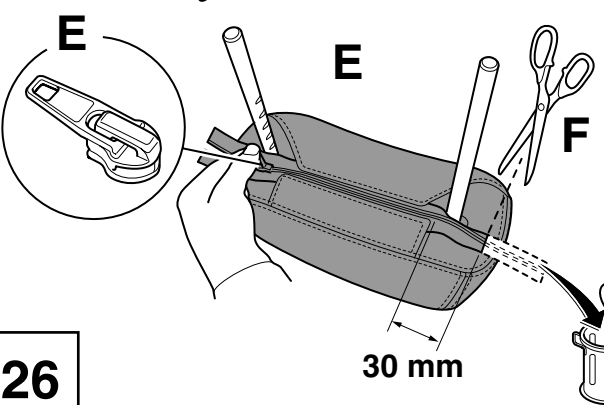
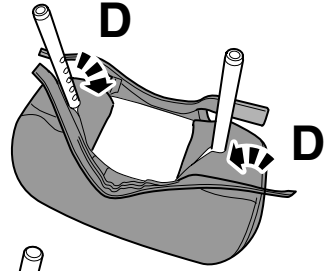
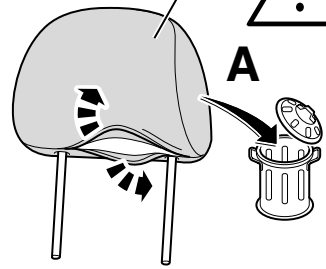

26

30 mm

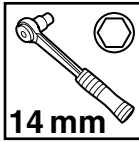

14 mm

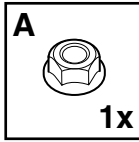

A

1x

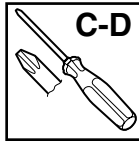

C-D

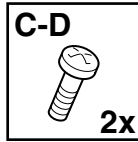

C-D

2x

L + R

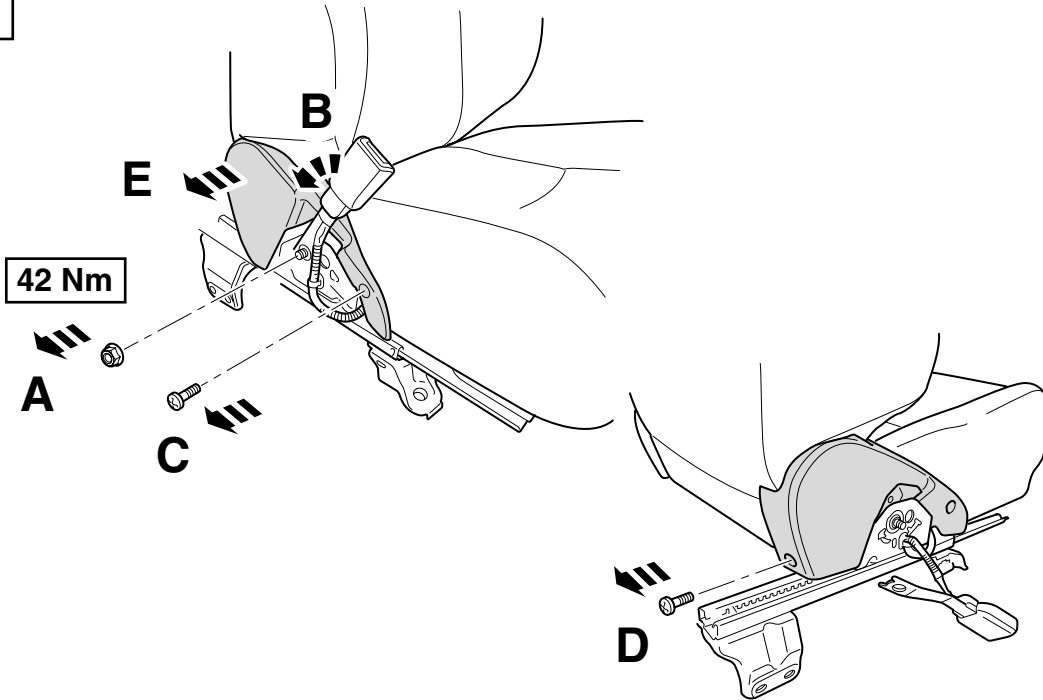

27

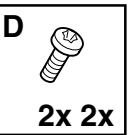
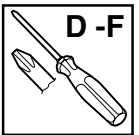
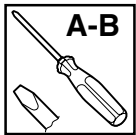

2x 2x

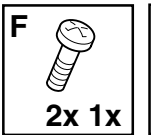

2x 1x

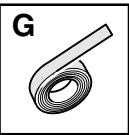

Front L + R

Tape to guard against scratches

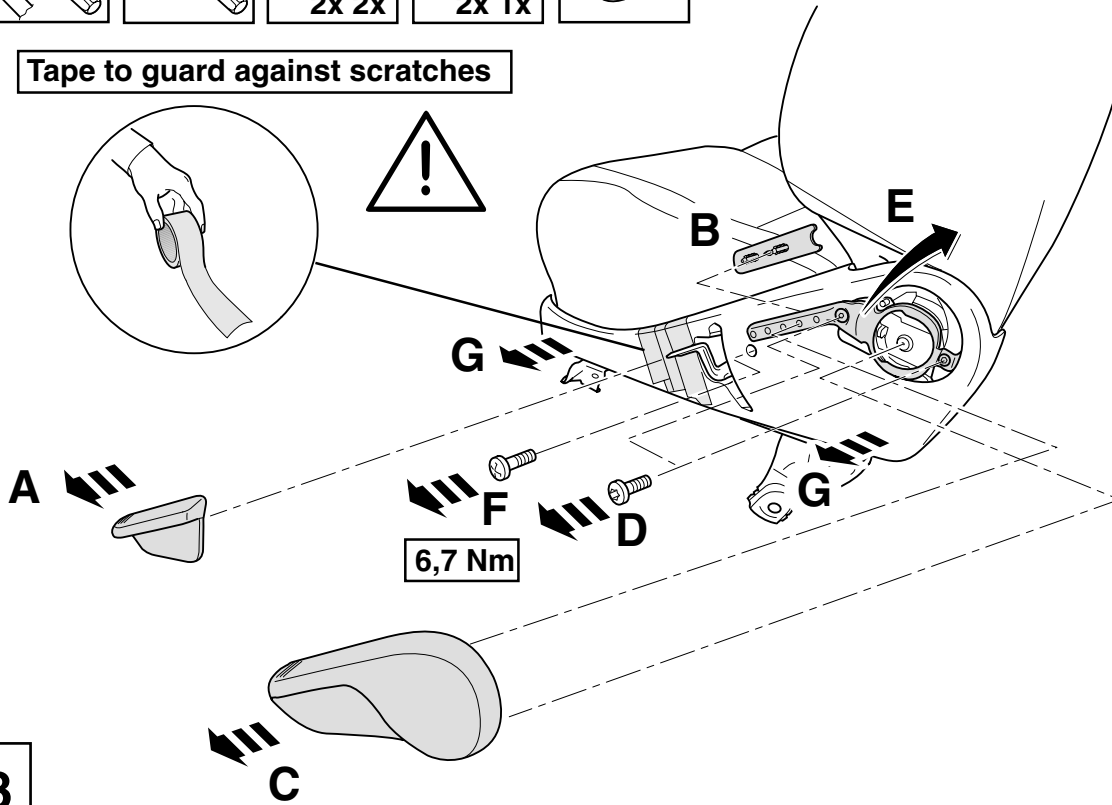
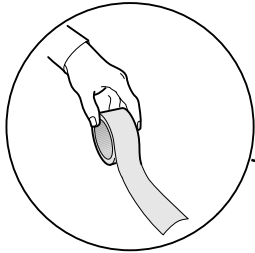

28

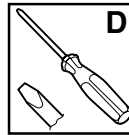
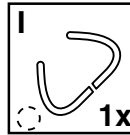
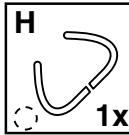
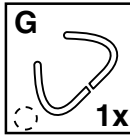
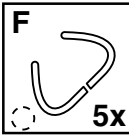
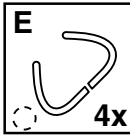
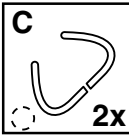

Front L + R

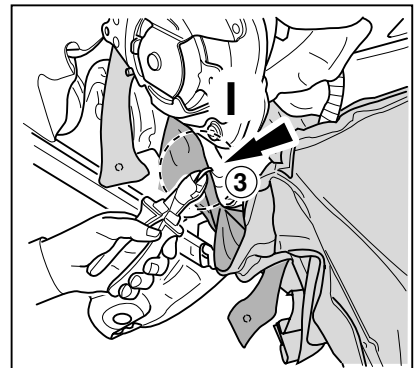
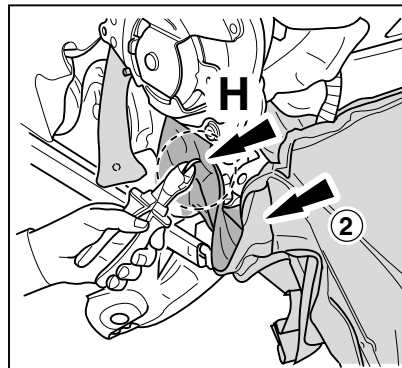
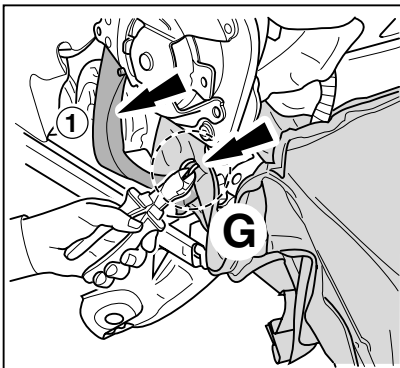
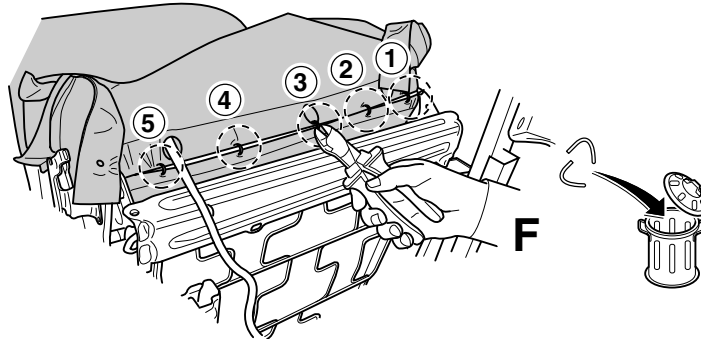
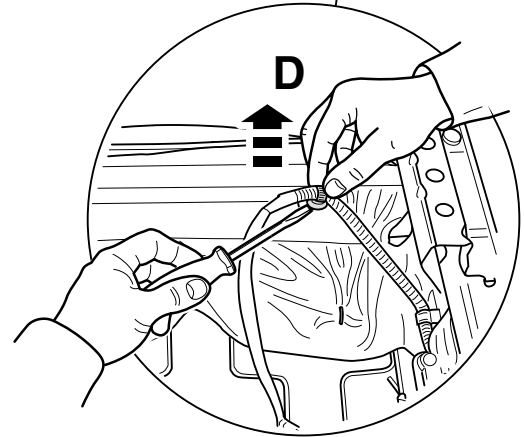
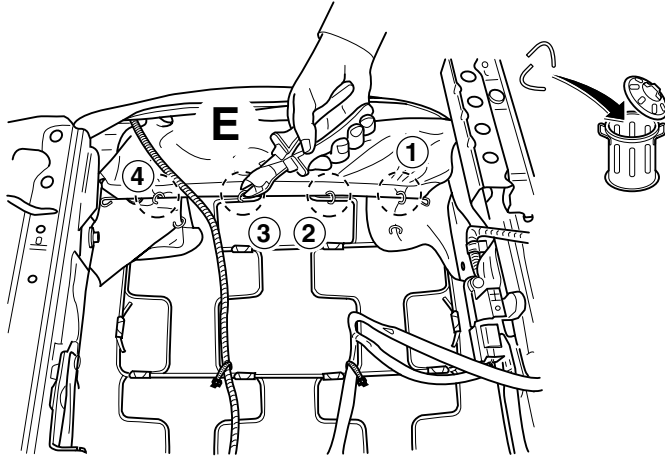
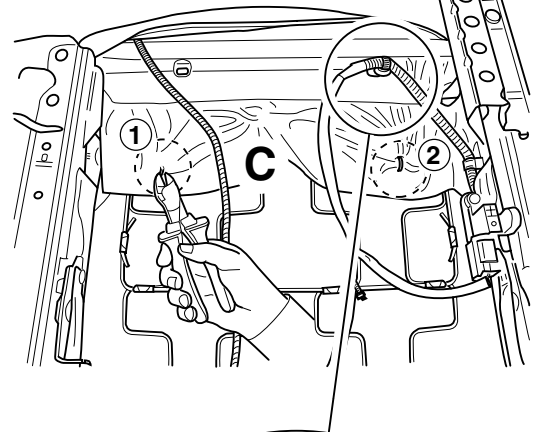
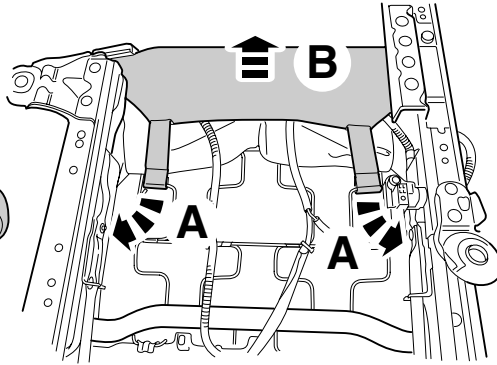
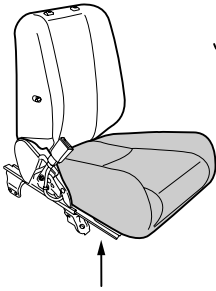

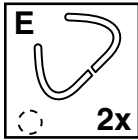
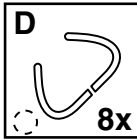
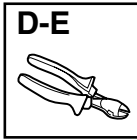
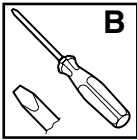
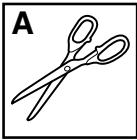

Front L + R

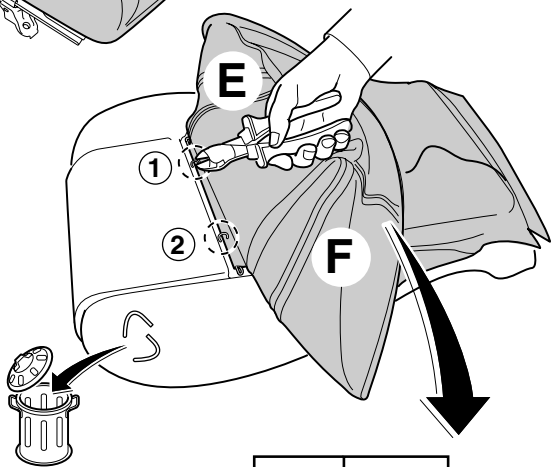
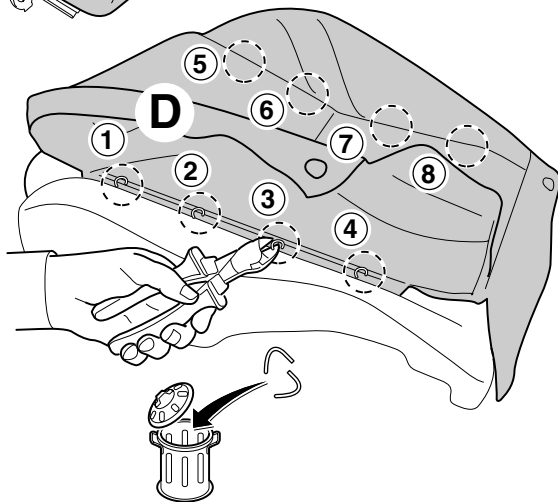
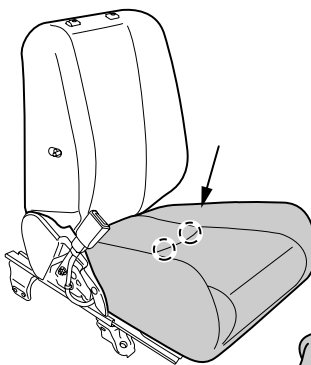
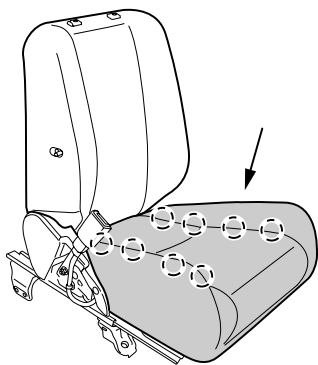
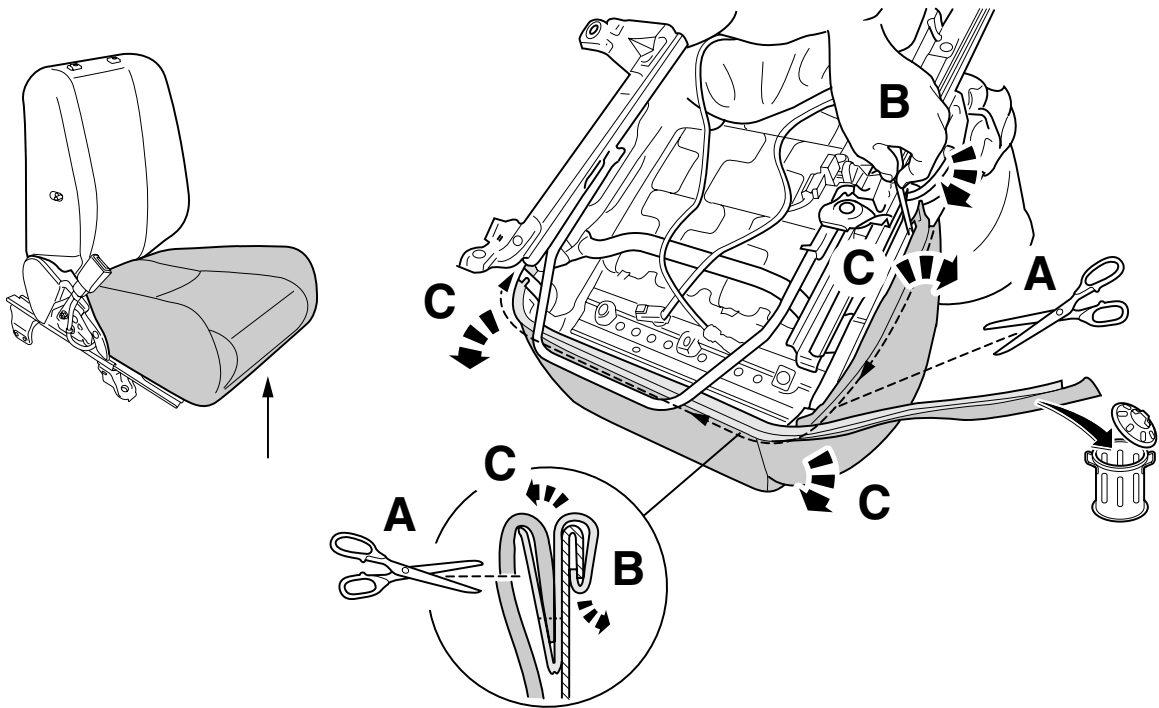

31

30

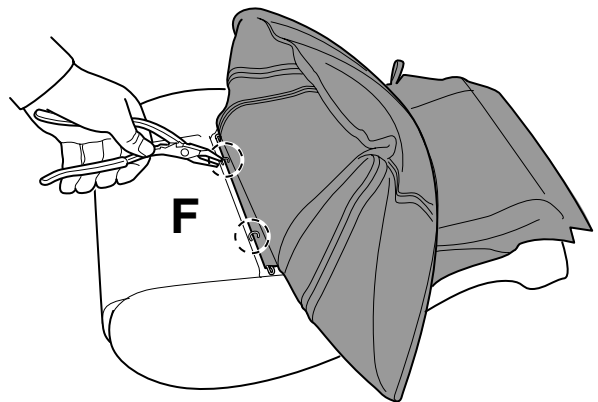
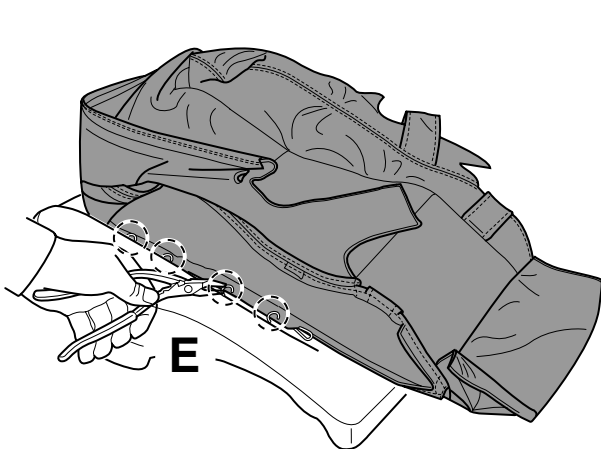
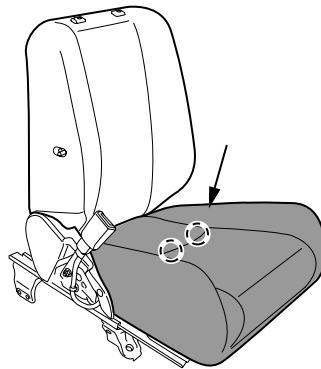
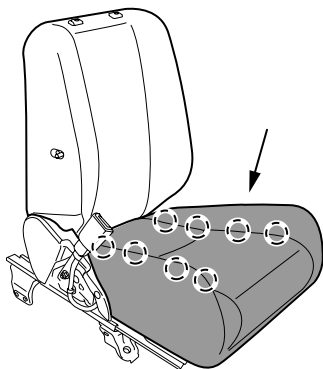
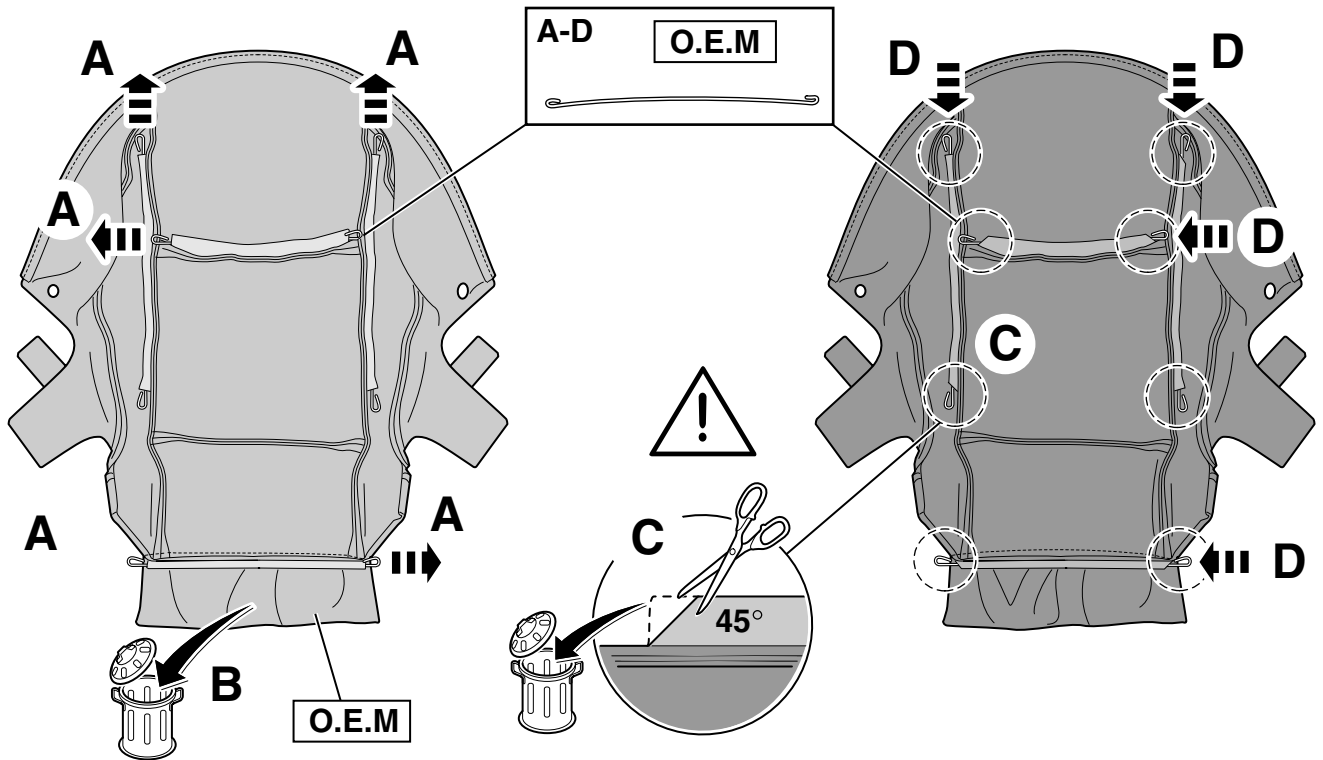
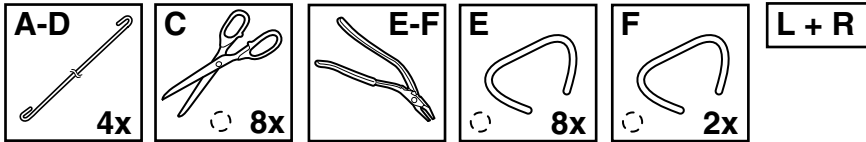

31

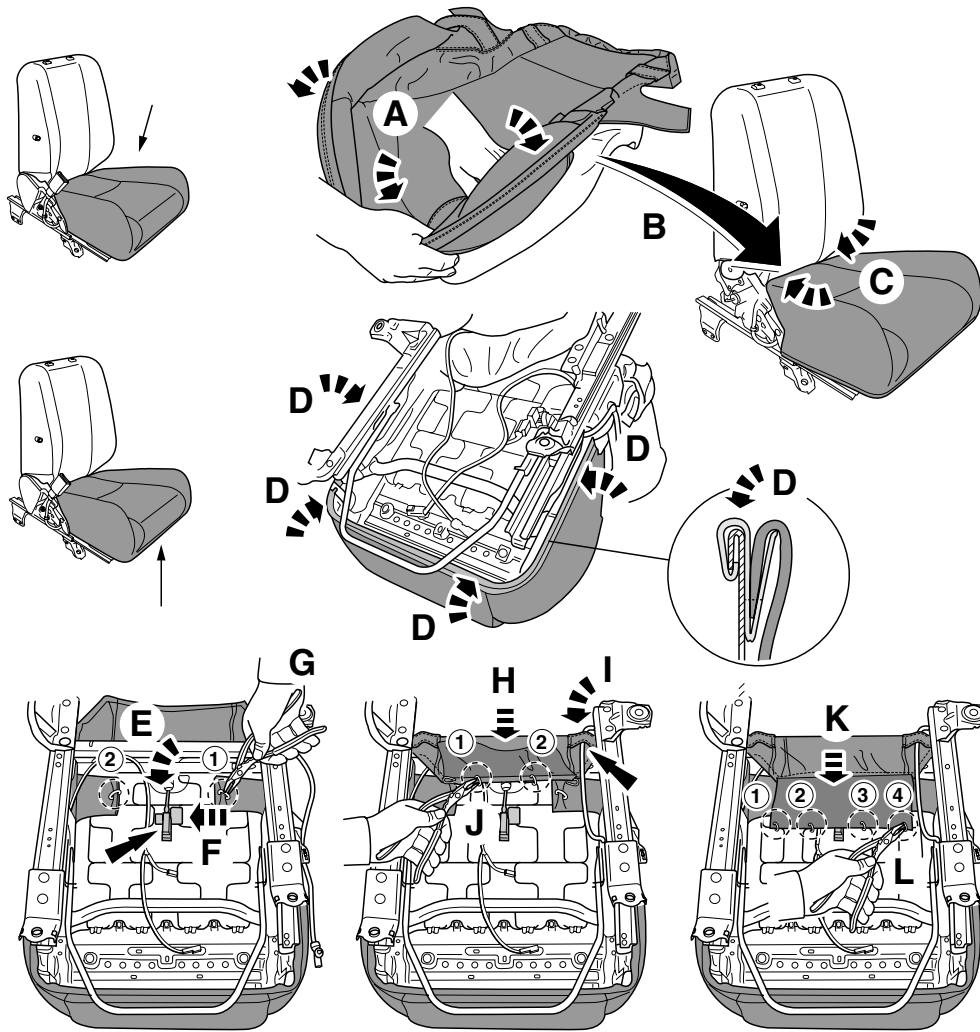
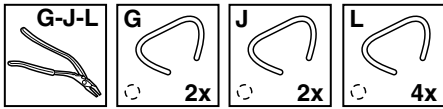

32

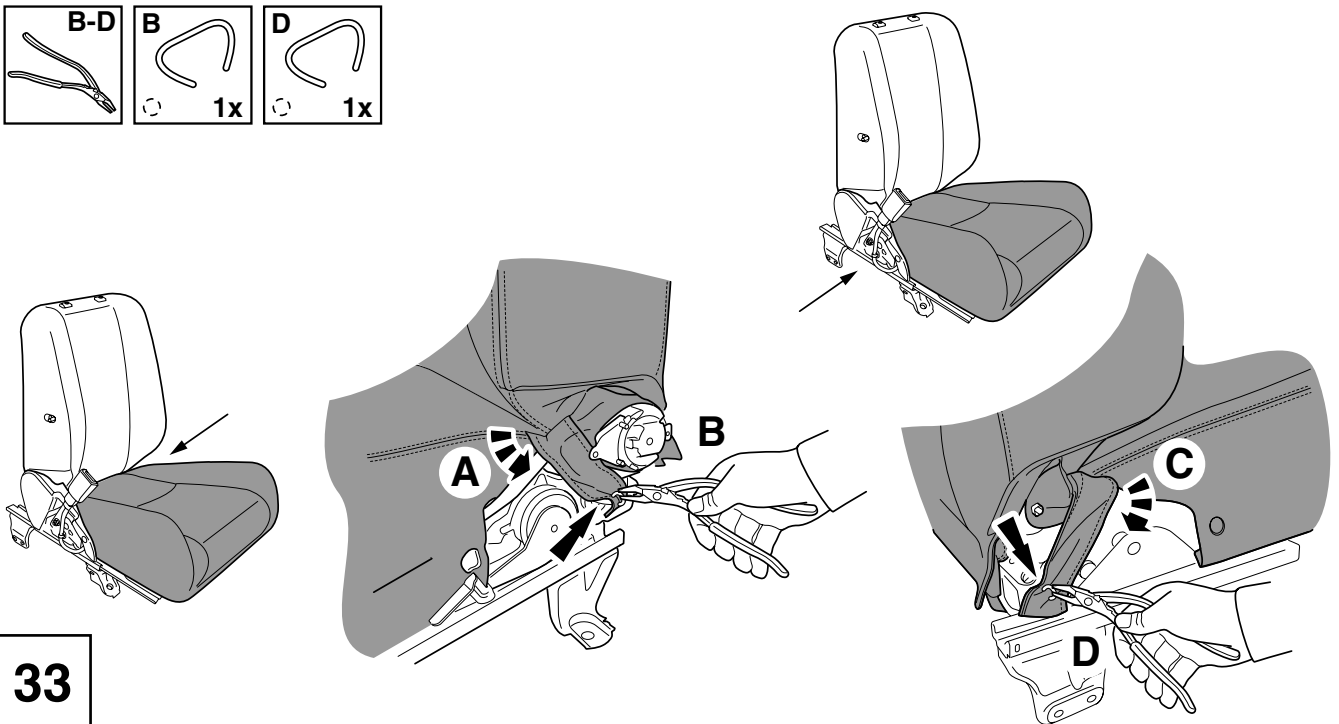
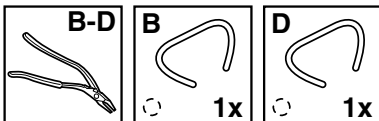

33

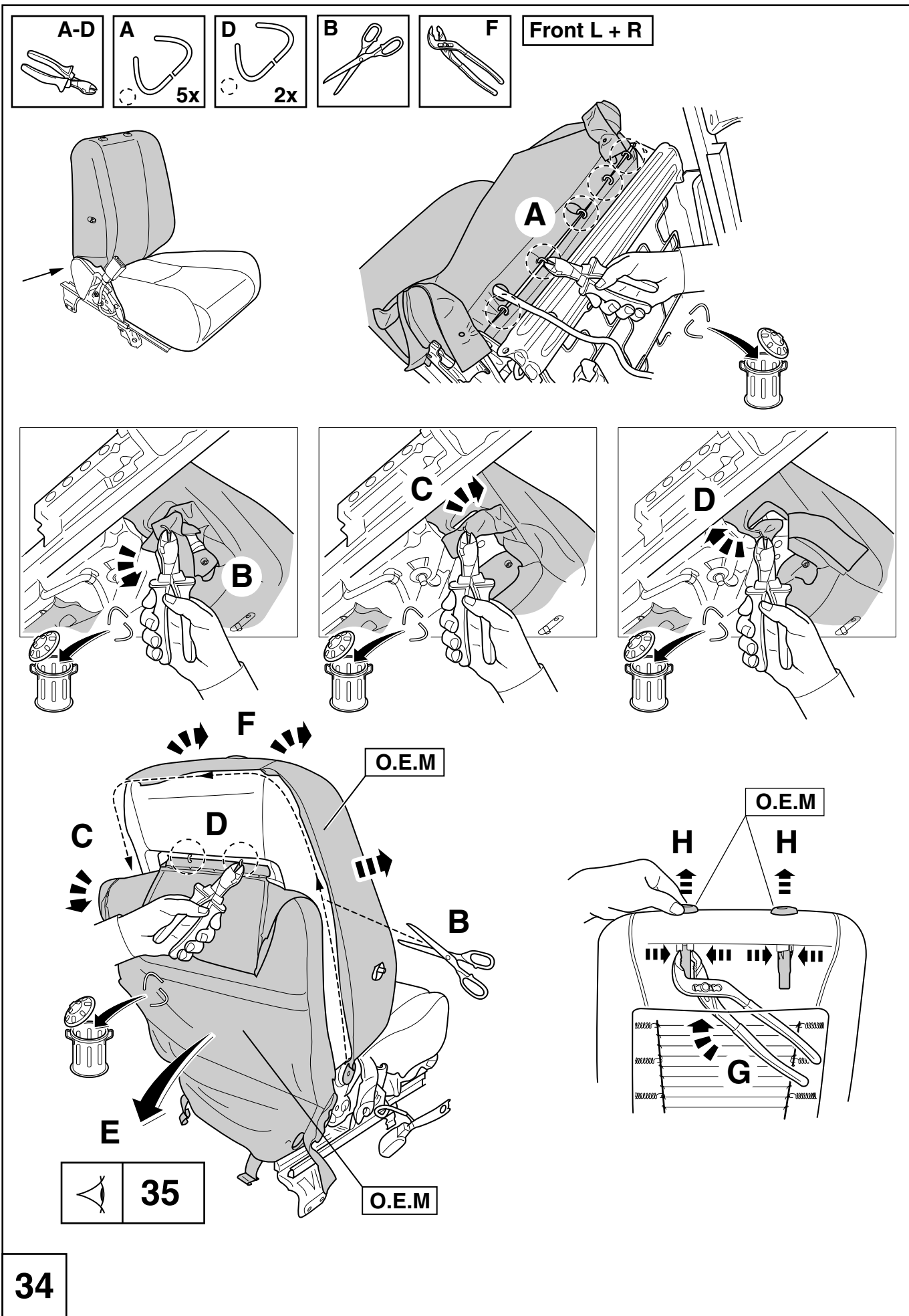

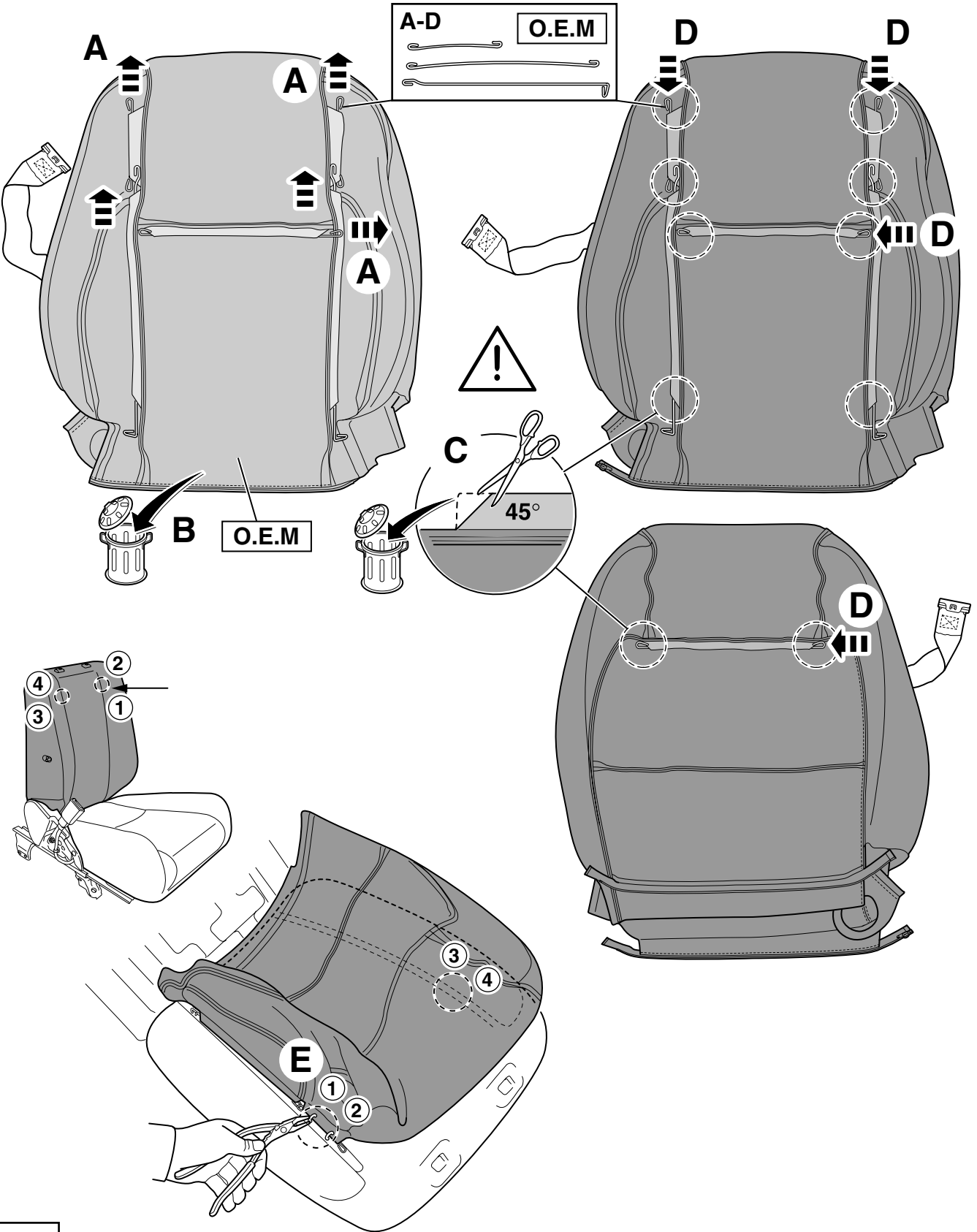
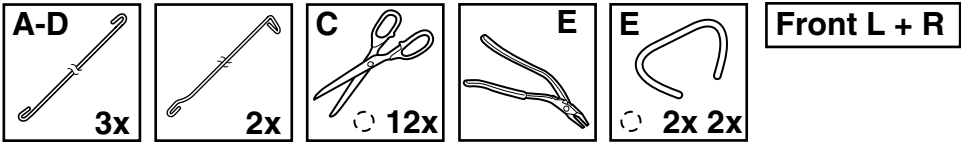

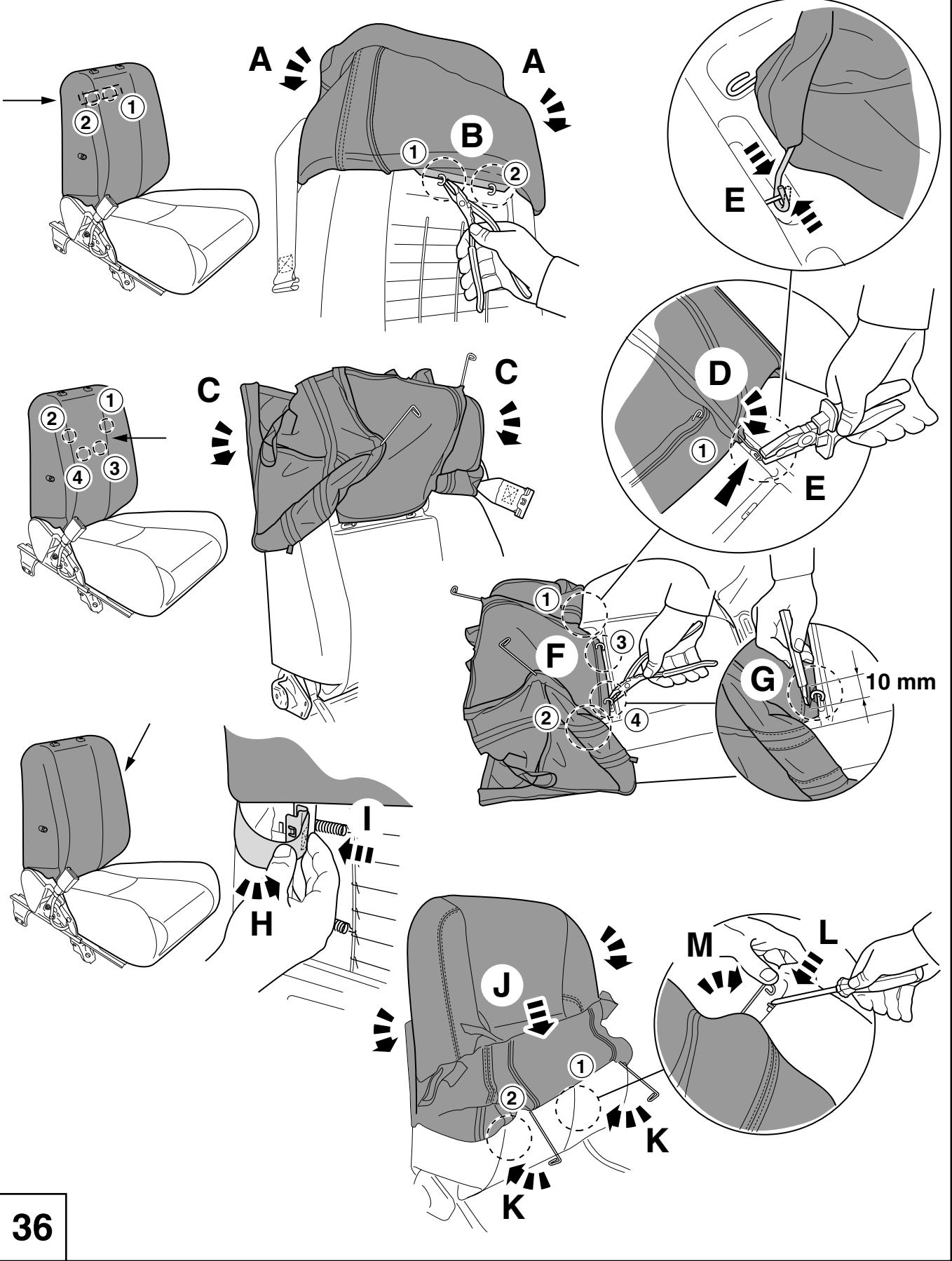
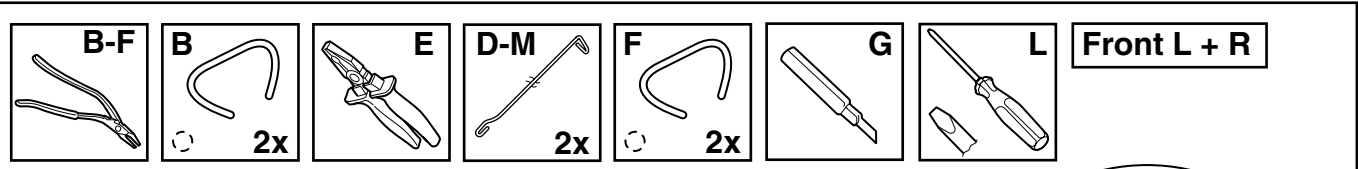



Front L + R



Two persons required for aprox. 5min.

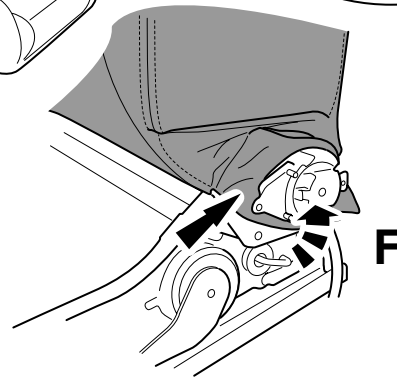
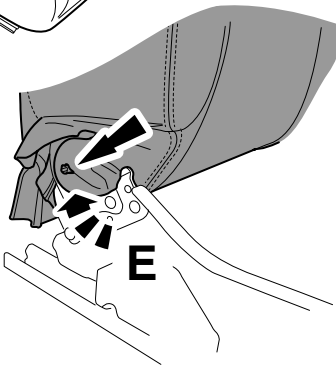
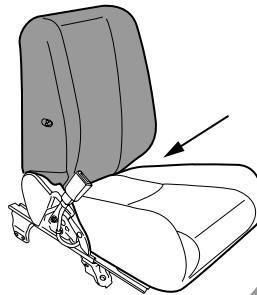
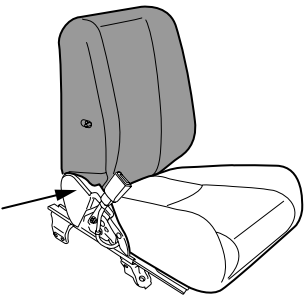
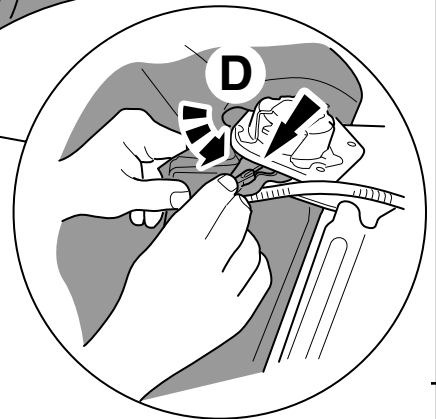
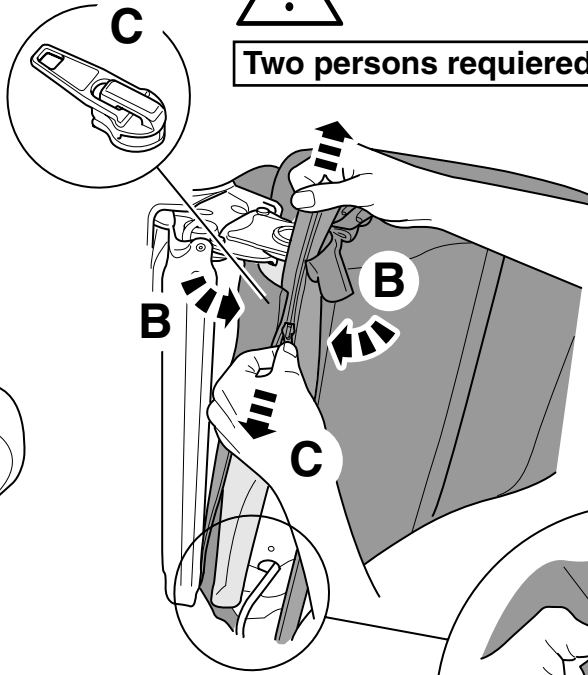
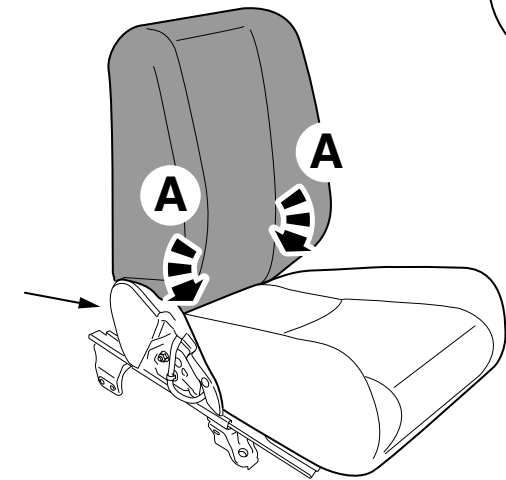

37

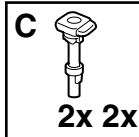
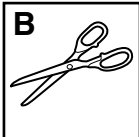
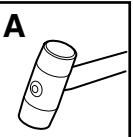

Front L + R

2x 2x

O.E.M

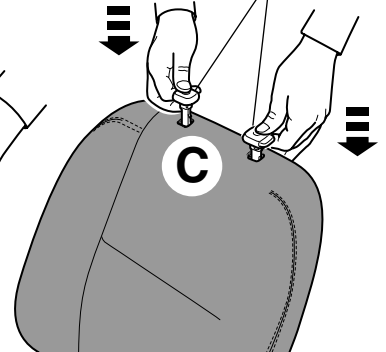
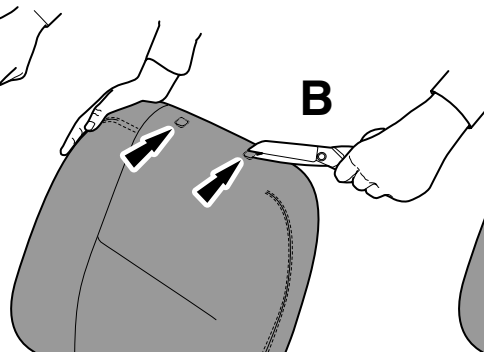
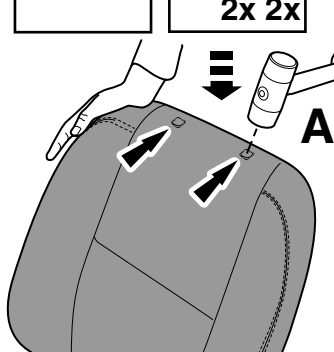

38

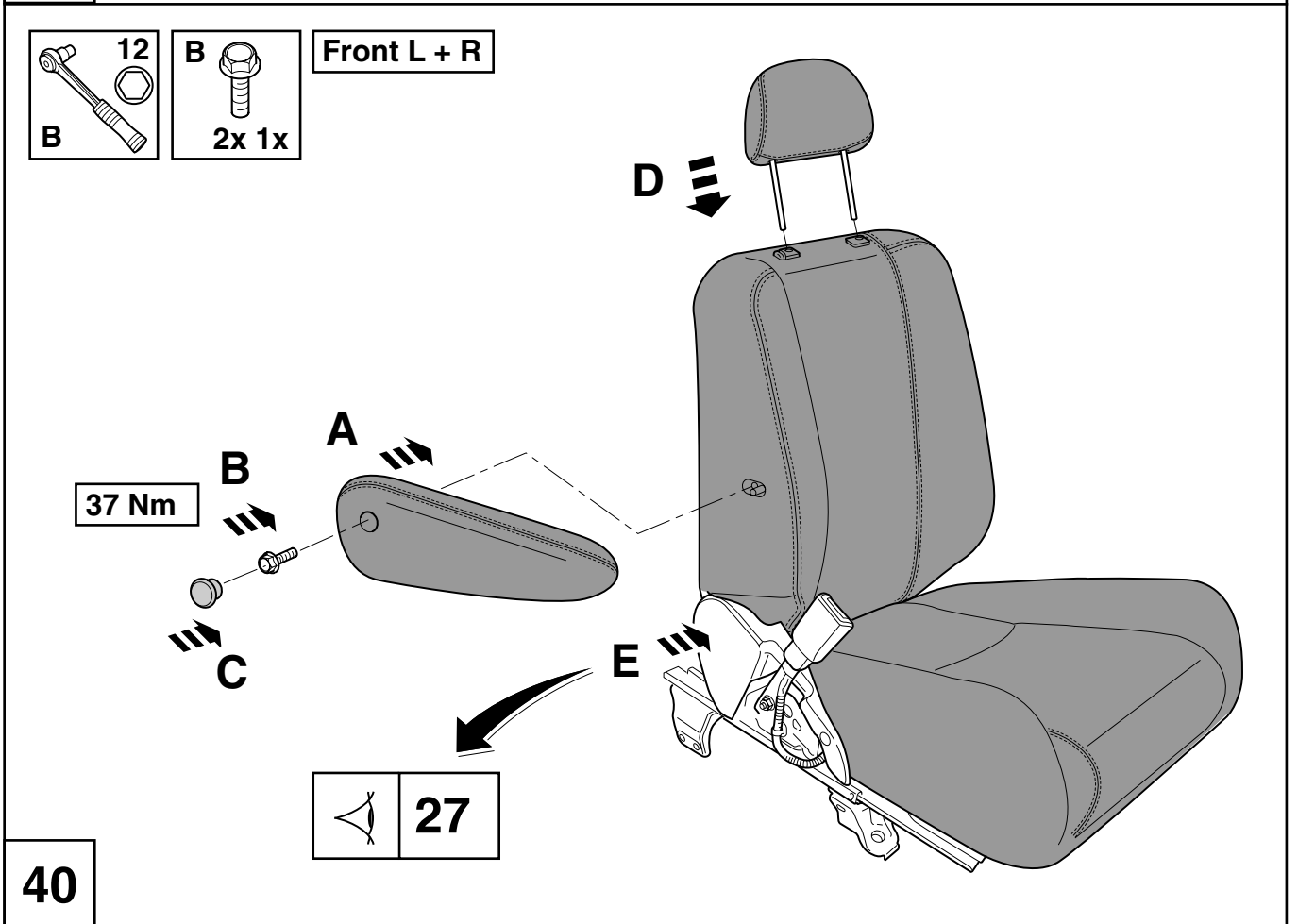
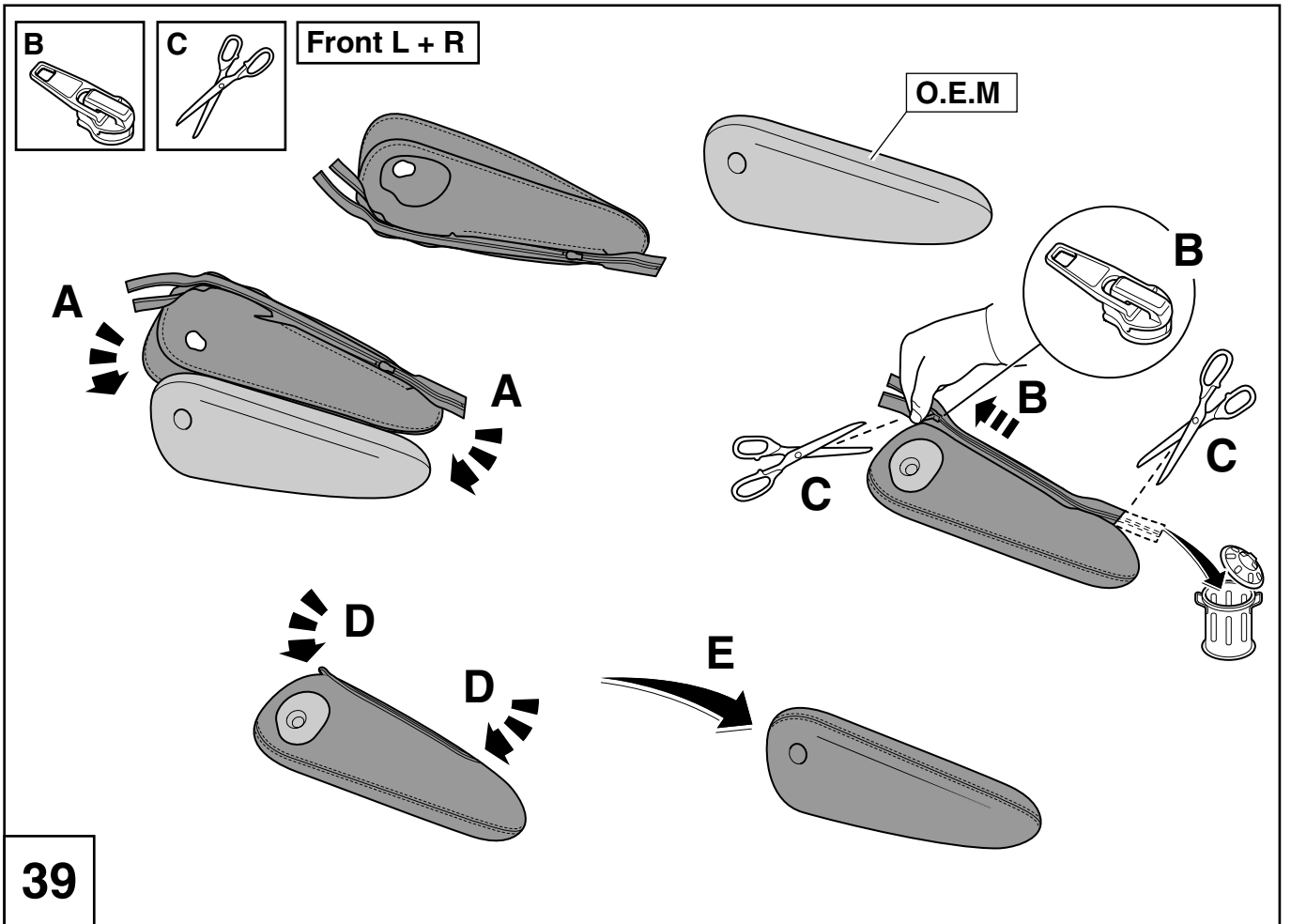

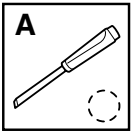
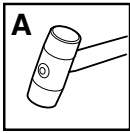

L + R

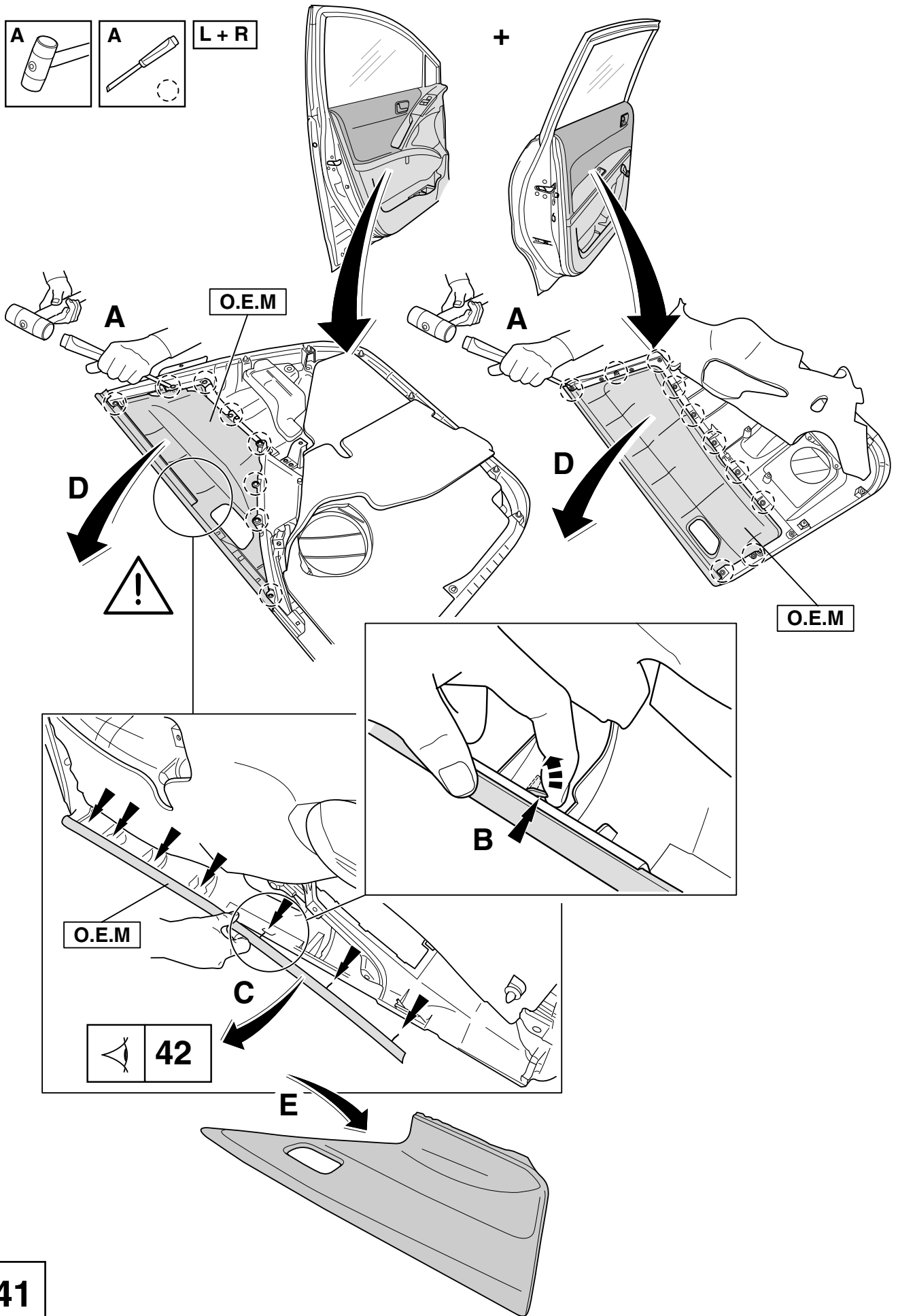

41

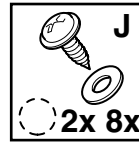
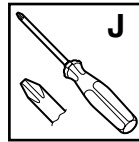
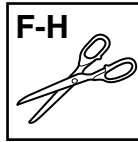
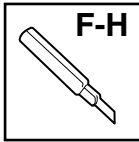
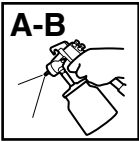

L + R

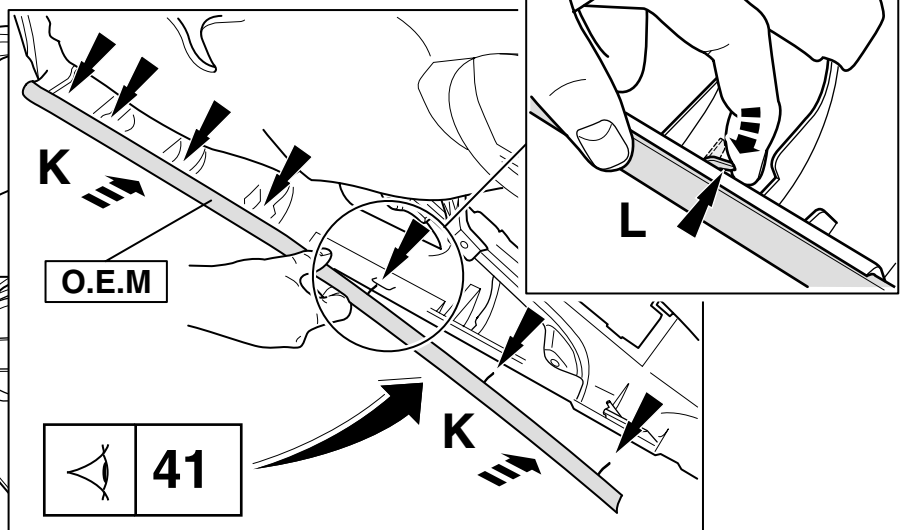
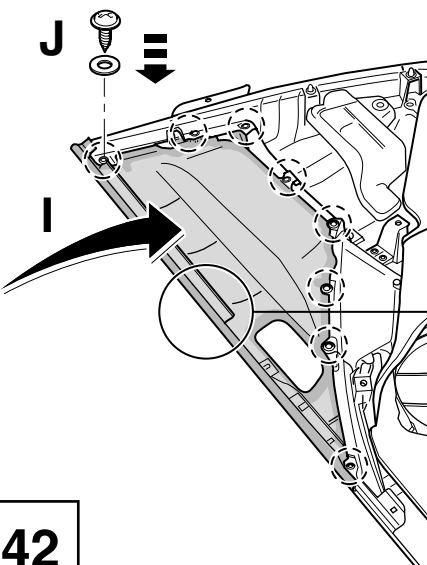
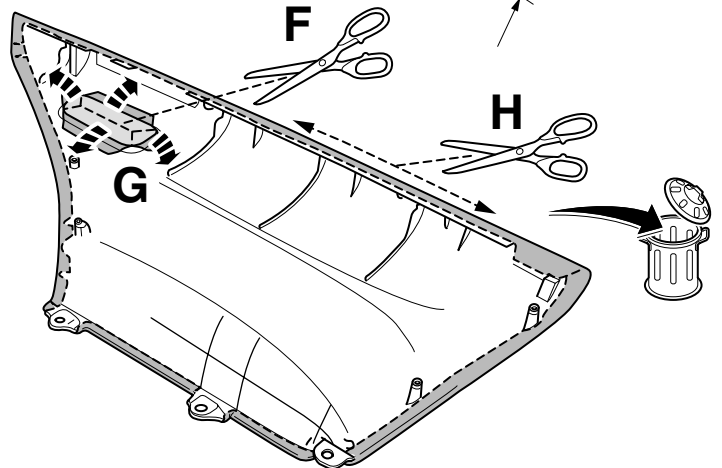
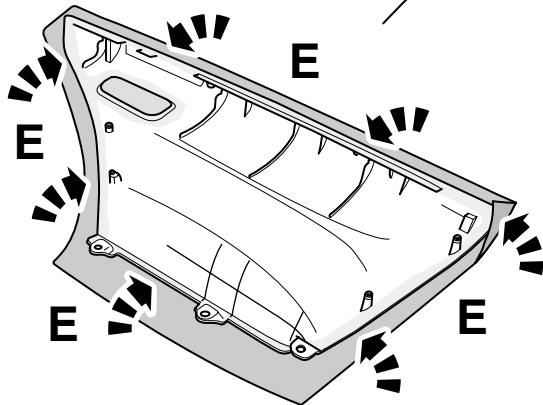
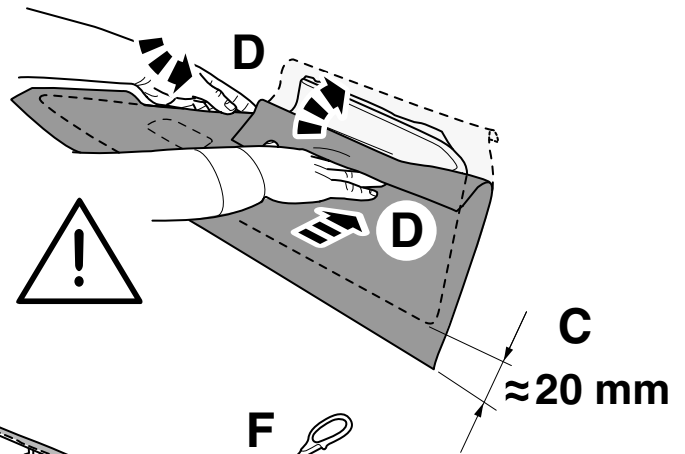
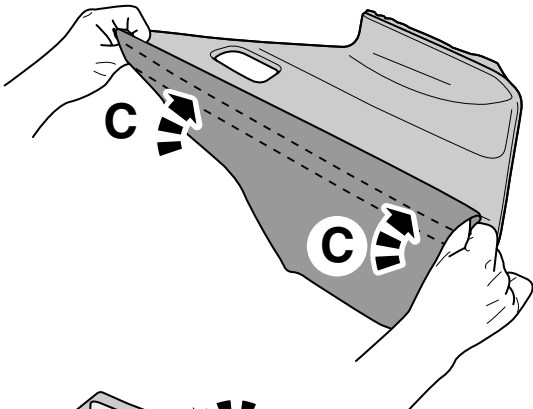
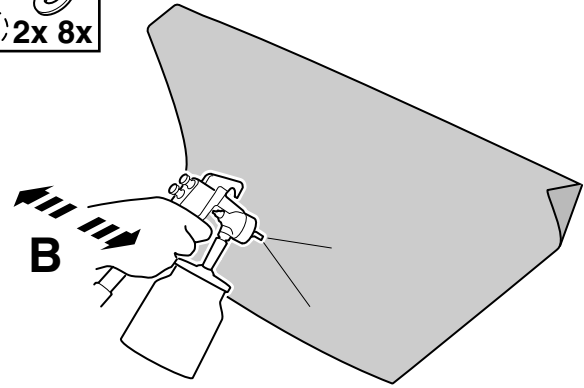
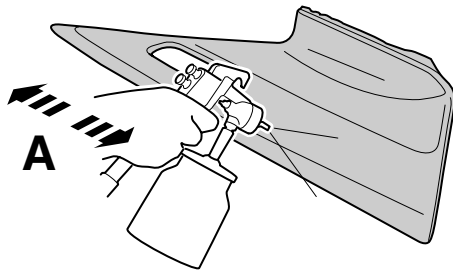

42