



Urban Cruiser

Console Box 2WD - 4WD



Installation instructions

Model year:	2009
Vehicle code:	N*P110*-AH***W for 2WD NLP115*-AH***W for 4WD
Part number:	08471-52810 (for 2WD) 08471-52820 (for 4WD)

Manual reference number: AIM 001 537-0

Revision Record

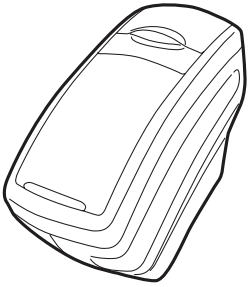
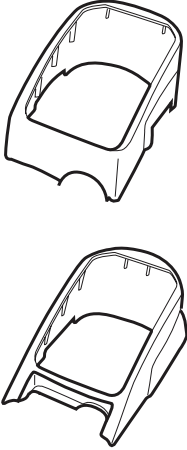
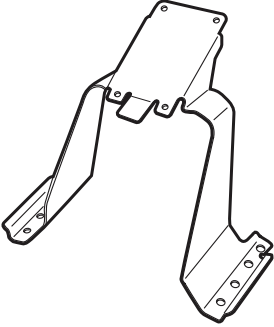
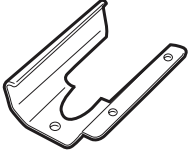
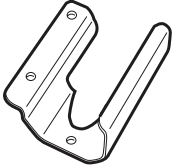
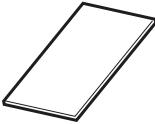
Rev. No.	Date	Page	Picture	Update	New	Deleted

<p>A</p>  <p>1x</p>	<p>B</p>  <p>2WD</p> <p>4WD</p> <p>1x</p>	
<p>C</p>  <p>1x</p>	<p>D</p>  <p>1x</p>	<p>E</p>  <p>1x</p>
<p>F</p>  <p>1x</p>	<p>G</p>  <p>M5x20</p> <p>4x</p>	<p>H</p>  <p>M5x12</p> <p>4x</p>

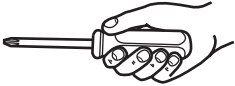

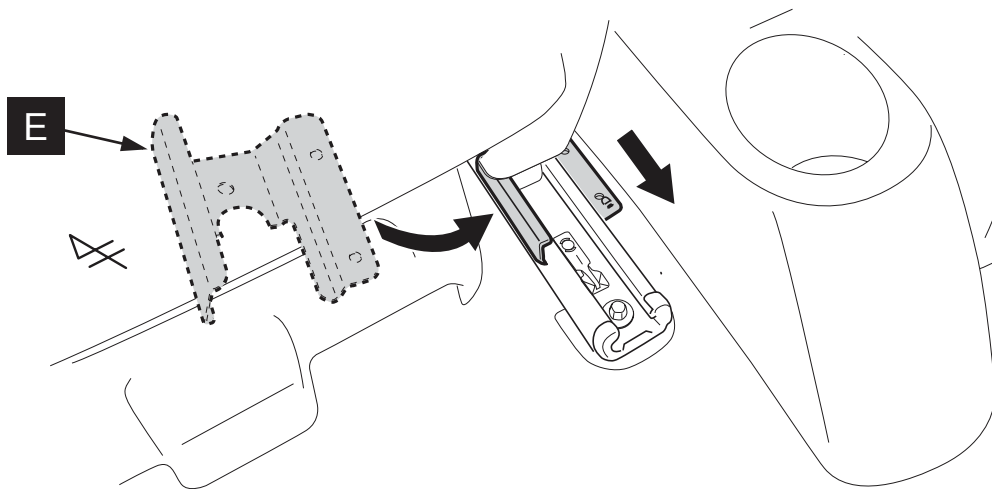
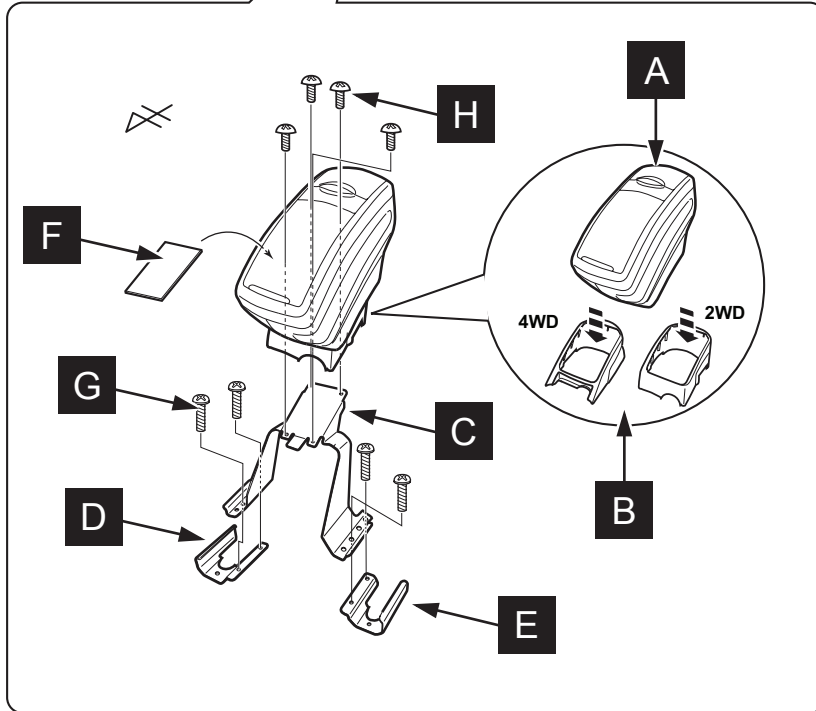
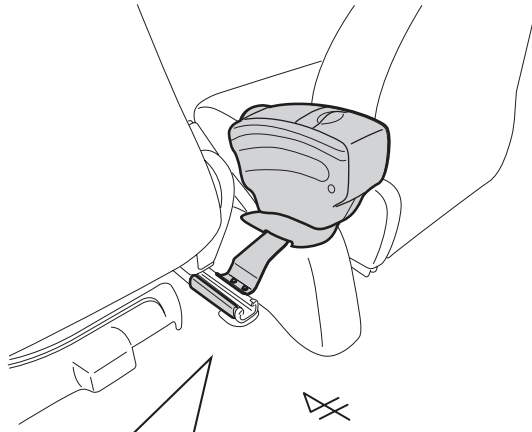

1

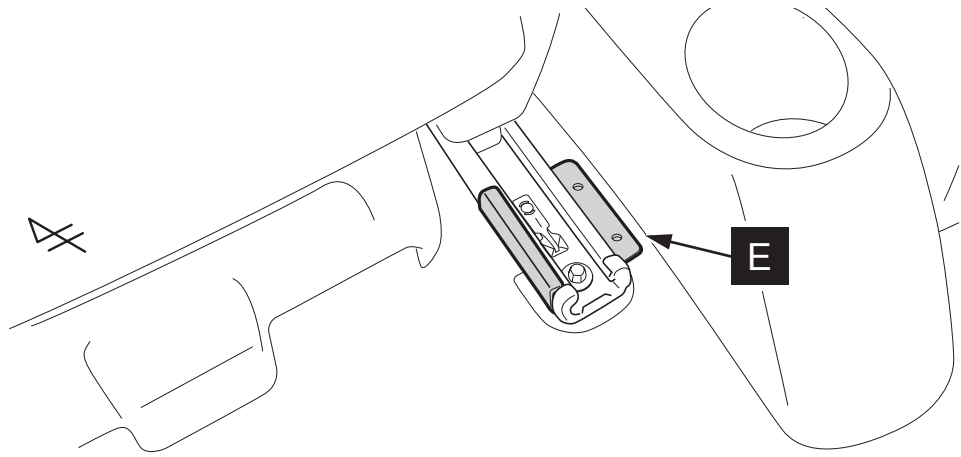

2

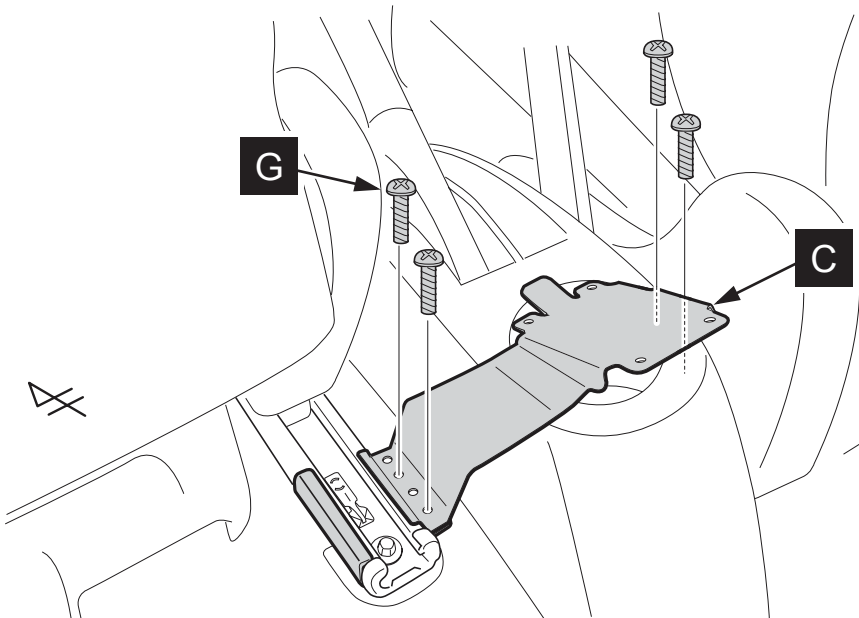

2WD

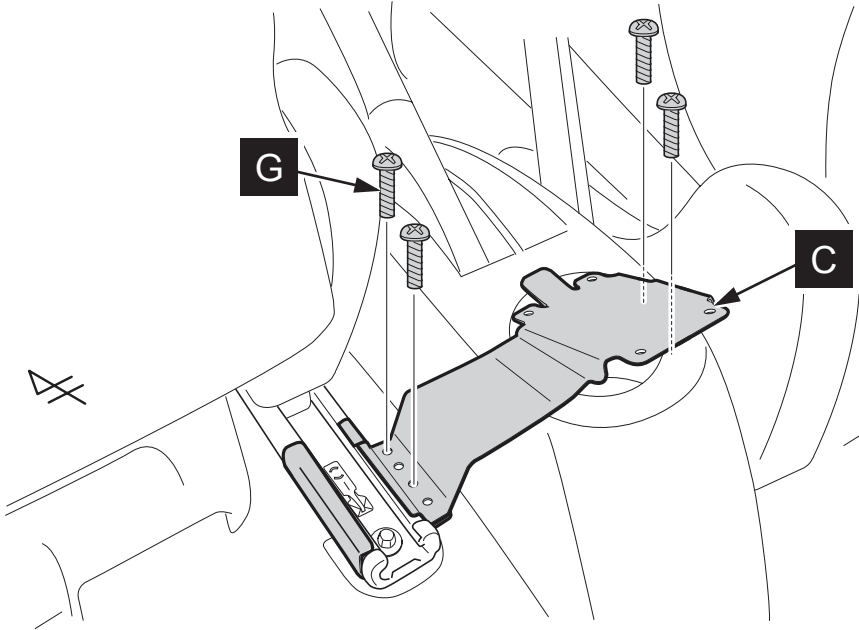

4WD

3

