



**TOYOTA**

ALWAYS A  
BETTER WAY

# Corolla (HB & 2.0L)

Towbar wiring kit 13-pin

Towbar wiring kit 7-pin

Installation Instructions

Model year:	2019/01	
Vehicle code:	NRE210*-DH**ZW, ZWE211*-DHX*BW, MZEH12*-DHX*BW	
Part number:	PW5D0-02562	13 Pin
	PW5D0-02563	7 Pin

Manual reference number: AIM 004 352-2

**EN**

- Expert Fitment Required.
- Disconnect the battery earth cable.
- To avoid damage to the wiring harness, ensure contact with sharp edges is prevented.
- Install parts as shown on illustrations.
- Re-connect battery.
- Re-fit panels, ensure that the wiring harness and other components are neatly and securely located.

**DE**

- Montage durch Fachwerkstatt erforderlich.
- Massekabel von Batterie abklemmen.
- Zur Vermeidung von Beschädigungen an der Isolierung ist Berührung mit scharfen Kanten zu vermeiden.
- Teile gemäß Abbildung montieren.
- Batterie wieder anschließen.
- Paneele wieder anbringen; achten Sie darauf, dass der Kabelbaum und andere Teile ordnungsgemäß und genau positioniert sind.

**ES**

- Montaje sólo por el concesionario.
- Desconectar el cable de masa de la batería.
- A efectos de evitar desperfectos en el aislamiento del cable, hay que evitar el contacto con aristas cortantes.
- Montar las piezas tal como se indica en las figuras.
- Vuelva a conectar la batería.
- Volver a colocar los paneles; preste atención a que el mazo del cable y las demás piezas tengan la posición correcta y precisa.

**FR**

- Montage par spécialiste nécessaire.
- Débrancher le câble de masse de la batterie.
- Eviter tout contact avec des arêtes vives afin de ne pas endommager l'isolation des câbles.
- Monter les pièces selon les figures.
- Reconnecter la batterie.
- Remette le panneau; veillez à ce que le faisceau et les autres pièces soient positionnés correctement et avec la précision requise.

**IT**

- E' necessario in officina specializzata.
- Staccare il cavo di massa dalla batteria
- Allo scopo di evitare danni all'isolazione dei cavi, evitare di metterli a contatto con spigoli acuti.
- Montare le parti secondo quanto rilevabile delle illustrazioni.
- Riconnettere la batteria.
- Rimettere in posizione i pannelli; far ben attenzione che il fascio di cavi e le altre parti siano state posizionate con esattezza e nella dovuta maniera.

**PT**

- Especialista em montagem requerido.
- Separe o cabo de terra do acumulador.
- Para não se danificar a isolação dos cabos, é conveniente evitar-se contacto com arestas afiadas.
- Monte as partes conforme ilustrado.
- Recolocar a bateria
- Tornar a colocar os painéis; verificar se a árvore de cabos e outras peças estão na posição exacta e prescrita.

**NL**

- Montage door vakman nodig.
- Massakabel van accu losmaken.
- Ter vermindering van beschadiging aan de isolatie van de elektrokit dient contact met scherpe kanten te worden vermeden.
- Delen overeenkomstig afbeelding monteren.
- Accu weer aansluiten.
- Panelen weer monteren; let erop, dat de kabelboom en andere delen correct en netjes gepositioneerd worden.

**DA**

- Montage ved professionelt værksted påkrævet.
- Stelkabel fjernes fra batteri.
- Berøring med skarpe kanter skal undgås for at undgå beskadigelse af kabelisoleringen.
- Dele skal monteres i henhold til illustrationer.
- Tilslut batteri igen.
- Paneler fastgøres igen; vær opmærksom på, at kabelsamlingen og andre dele placeres korrekt og præcist.

**NO**

- Nødvendig med montering fra fagverksted.
- Klem jordkabelen av batteriet.
- For å unngå skader på kabelisoleringen må berøring av skarpe kanter unngås.
- Monter alle deler i henhold til illustrasjonene.
- Tilkopli batteriet igjen.
- Monter panelene igjen, og pass på at kabelbunten og andre deler er anbrakt ordentlig og på riktig sted.

**SV**

- Verkstadsmontage erfordras.
- Lossa stomkabeln från batteriet.
- För att förhindra skador på ledningarnas isolation skall berøring med vassa kanter undvikas.
- Montera detaljerna enligt figurerna
- Anslut batteriet igen.
- Sätt tillbaka panelerna igen; kontrollera noga att ledningsmattan och andra detaljer ligger på rätt plats.

**FI**

- Asennus tarpeen merkikorkaamossa.
- Erotta maadoitusjohto akusta
- Pidä huoli myös siitä, että kaapelointi on korin kiinnityksen myötäinen ja kiinnitetty huolellisesti muihin liikkuviin osiin.
- Asenna osat kuvien mukaan.
- Kytke akku takaisin.
- Aseta paneelit paikalleen; tarkista, että kaapelointi ja muut osat ovat asianmukaisesti ja tarkalleen paikoillaan.

**CS**

- Montáž ve specializované dílně nutná.
- Odpojte zemnicí kabel od baterie.
- Zabraňte tomu, aby se kabely poškodily tím, že jsou položeny na ostrých hranách.
- Montujte části podle vyobrazení
- Opět připojte baterii.
- Opět připevněte panely; dbejte na to, aby svazek kabelů a ostatní části byly uloženy na správném místě.

**HU**

- A szereléshez szakműhely kell.
- Húzza le az akkumulátor testkábéljét.
- A kábelszigetelés megsérülésének elkerülésére ügyeljen arra, hogy a kábel ne juthasson érintkezésbe éles peremű alkatrészekkel.
- Az alkatrészeket az ábrák szerint szerelje be.
- Ismét csatlakoztassa az akkumulátort.
- Szerelje vissza a fedőlapokat, ügyeljen arra, hogy a ábelek és a többi alkatrészek pontosan a számukra kijelölt helyen maradjanak.

**EL**

- Να τοποθετεί από συνεργείο.
- Αποσυνδέστε το καλώδιο γείωσης από τη μπαταρία.
- Για να αποφευχθούν ζημιές στη μόνωση καλωδίων, να αποφεύγεται η επαφή των με αιχμηρές ακμές.
- Τοποθέτηση των μερών σύμφωνα με τις Εικόνες.
- Συνδέστε πάλι τη μπαταρία.
- Τοποθετήστε πάλι το κάλυμμα- προσοχή, η πλεξούδα καλωδίων και άλλα μέρη να είναι τοποθετημένα ακριβώς και σύμφωνα με τους κανονισμούς.

**TR**

- Uzmanın takması gereklidir.
- Akü toprak kablosunu ayırın.
- Kablo demetinin hasar görmemesi için, sivri objelerle temasın engellenmesini sağlayın.
- Parçaları çizimlerde gösterildiği gibi takın.
- Aküyü tekrar bağlayın.
- Panoları tekrar takın, kablo demeti ve diğer komponentlerin tam ve sıkıca yerleşmesini sağlayın.

**ET**

- Paigaldada spetsialisti poolt.
- Võtke massikaabel aku küljest lahti.
- Juhtmestiku kahjustamise vältimiseks hoidke juhtmed eemal teravatest servadest.
- Paigaldage osad vastavalt joonistele.
- Ühendage aku.
- Paigaldage kattepaneelid; veenduge, et juhtmestik ja muud osad on paigutatud korrektselt ning kindlalt.

**LT**

- Būtina, kad sumontuotų specialistas.
- Atjunkite akumuliatoriaus įžeminimo laidą.
- Tam, kad išvengtumėte įvado apgadinimo, saugokite, kad laidai nesiliestų prie aštrių briaunų.
- Sumontuokite dalis taip, kaip pavaizduota iliustracijoje.
- Prijunkite akumuliatorių.
- Į vietas įdėkite skydelius, patikrinkite, ar laidų šarvai ir kiti komponentai yra savo vietose ir gerai pritvirtinti.

**SL**

- Potrebna je strokovna montaža.
- Odklopite ozemljitveni kabel akumulatorja.
- Da preprečite poškodbe kablskega snopa, preprečite stik z ostrimi robovi.
- Dele namestite, kot je prikazano na slikah.
- Ponovno priklonite akumulator.
- Ponovno montirajte panele in zagotovite, da so kablски snop in druge komponente nameščene varno.

**PL**

- Konieczny montaż przez warsztat specjalistyczny.
- Odłączyć przewód masy od akumulatora.
- Dla zapobieżenia uszkodzeniu izolacji chronić przed zetknięciem z ostrymi krawędziami.
- Zamontować części zgodnie z rysunkiem.
- Ponownie podłączyć akumulator.
- Na powrót osadzić osłony; zadbać aby wiązka kablowa i inne części były właściwie i dokładnie ułożone.

**RU**

- Монтаж должны выполнять специалисты в мастерской
- Отсоединить заземляющий кабель аккумулятора
- Во избежание повреждений изоляции кабеля не допускать соприкосновения с острыми углами
- Монтировать части согласно иллюстрации
- Снова подключить аккумулятор
- Установить панель, проверить правильность и точность расположения кабелей и других частей.

**BG**

- Изисква се поставяне от специалист.
- Откачете заземляващия кабел на акумулатора.
- За избягване на повреди по кабелния сноп се уверете, че няма контакт с остри ръбове.
- Монтирайте частите според показаното на илюстрацията.
- Свържете отново акумулатора.
- Поставете отново панелите, уверете се, че кабелният сноп и останалите компоненти са разположени подредено и надеждно.

**LV**

- Nepieciešami īpaši saliekamie elementi.
- Atvienojiet akumulatora zemējuma vadu.
- Lai nesabojātu elektroinstalāciju, nepieskarieties tai ar asiem priekšmetiem.
- Uzstādiet detaļas, kā parādīts attēlos.
- Pievienojiet akumulatoru.
- Uzlieciet paneļus, raugieties, lai elektroinstalācija un citas daļas būtu kārtīgi un stingri nofiksētas.

**RO**

- Este necesară instalarea de către un specialist.
- Deconectați cablul de împământare a bateriei.
- Pentru a evita deteriorarea cablajului, evitați contactul cu muchiile ascuțite.
- Montați componentele așa cum este prezentat în figuri.
- Reconectați bateria
- Reinstalați panourile, aveți grijă de plasarea îngrijită și în condiții de siguranță a cablajului și a celorlalte componente.

**SK**

- Vyžaduje sa profesionálne vybavenie.
- Odpojte zemniaci vodič akumulátora.
- Káblové zväzky sa nesmú dotýkať ostrých okrajov, aby sa nepoškodili.
- Dielce založte tak, ako je znázornené na obrázkoch.
- Znovu zapojte akumulátor.
- Založte panely a uistite sa, že káblové zväzky a iné dielce sú bezpečne a prehľadne uložené.

	EN	DE	ES	FR	IT	PT	NL	DA	NO	SV	FI	CS
<b>L</b>	Blue	Blau	Azul	Bleu	Blu	Azul	Blauw	Blå	Blå	Blå	Sininen	Modrá
<b>B</b>	Black	Schwarz	Negro	Noir	Nero	Preto	Zwart	Sort	Sort	Svart	Musta	Černá
<b>BR</b>	Brown	Braun	Marrón	Marron	Marrone	Castanho	Bruin	Brun	Brun	Brun	Ruskea	Hnědá
<b>DL</b>	Dark blue	Dunkelblau	Azul oscuro	Bleu foncé	Blu scuro	Azul-escuro	Donkerblauw	Mørkeblå	Mørkeblå	Mørkeblå	Tummansininen	Tmavomodrá
<b>DG</b>	Dark green	Dunkelgrün	Verde oscuro	Vert foncé	Verde scuro	Verde-escuro	Donkergroen	Mørkegrøn	Mørkegrønn	Mörkgrön	Tummanvihreä	Tmavozelená
<b>G</b>	Green	Grün	Verde	Vert	Verde	Verde	Groen	Grøn	Grønn	Grön	Vihreä	Zelená
<b>GR</b>	Grey	Grau	Gris	Gris	Grigio	Cinzeno	Grijs	Grå	Grå	Grå	Harmaa	Šedá
<b>LA</b>	Lavender	Lavendel	Lavanda	Lavande	Lavanda	Lavanda	Lavendel	Lavendel	Lavendel	Lavendel	Laventeli	Levandulová
<b>LB</b>	Light blue	Hellblau	Azul claro	Bleu clair	Blu chiaro	Azul-claro	Lichtblauw	Lyseblå	Lyseblå	Ljusblå	Vaaleansininen	Bleděmodrá
<b>LG</b>	Light green	Hellgrün	Verde claro	Vert clair	Verde chiaro	Verde-claro	Lichtgroen	Lysegrøn	Lysegrønn	Ljusgrön	Vaaleanvihreä	Světlezelená
<b>NO</b>	Natural colour	Naturfarben	Color natural	Nature	Colori naturali	Cores naturais	Naturel	Naturfarvet	Naturfarger	Naturfärger	Luonnonväri	Přírodní barva
<b>O</b>	Orange	Orange	Naranja	Orange	Arancione	Laranja	Oranje	Orange	Orange	Orange	Oranssi	Oranžová
<b>P</b>	Pink	Rosa	Rosa	Rose	Rosa	Rosa	Rosé	Rosa	Rosa	Rosa	Rosa	Růžová
<b>R</b>	Red	Rot	Rojo	Rouge	Rosso	Vermelho	Rood	Rød	Rød	Röd	Punainen	Červená
<b>PU</b>	Purple	Purpur	Púrpura	Pourpre	Rosso porpora	Púrpura	Paars	Purpur	Purpur	Purpur	Purppura	Purpurová
<b>SB</b>	Sky blue	Himmelblau	Azul cielo	Bleu ciel	Celeste	Azul-céu	Hemelsblauw	Himmelblå	Himmelblå	Himmelsblå	Taivaansininen	Blankytná
<b>T</b>	Yellow brown	Gelbbraun	Amarillo-marrón	Marron-jaune	Giallomarrone	Castanho-amarelado	Geelbruin	Gulbrun	Gulbrun	Gulbrun	Keltaisenruskea	Žlutohnědá
<b>W</b>	White	Weiß	Blanco	Blanc	Bianco	Branco	Wit	Hvid	Hvit	Vit	Valkoinen	Bílá
<b>Y</b>	Yellow	Gelb	Amarillo	Jaune	Giallo	Amarelo	Geel	Gul	Gul	Gul	Keltainen	Žlutá
<b>V</b>	Violet	Violett	Violeta	Violet	Viola	Violeta	Violet	Violet	Fiolett	Violett	Violett	Fialová

	HU	PL	EL	RU	TR	BG	ET	LV	LT	RO	SL	SK
<b>L</b>	Kék	Niebieska	Μπλε	Синий	Mavi	Синьо	Sinine	Zils	Mélyna	Albastru	Modra	Modrá
<b>B</b>	Fekete	Czarna	Μαύρο	Чёрный	Siyah	Черно	Must	Melns	Juoda	Negru	Črna	Čierna
<b>BR</b>	Barna	Brazowa	Καφέ	Коричневый	Kahverengi	Кафяво	Pruun	Brūns	Ruda	Maro	Rjava	Hnedá
<b>DL</b>	Sötétkék	Granatowa	Σκούρο μπλε	Тёмно-синий	Koyu mavi	Тъмносиньо	Tumesinine	Tumši zils	Tamsiai mélyna	Albastru închis	Temno modra	Tmavomodrá
<b>DG</b>	Sötétzöld	Ciemnozielona	Σκούρο πράσινο	Тёмно-зелёный	Koyu yesil	Тъмнозелено	Tumeroheline	Tumši zaļš	Tamsiai žalia	Verde închis	Temno zelena	Tmavozelená
<b>G</b>	Zöld	Zielona	Πράσινο	Зелёный	Yeşil	Зелено	Roheline	Zaļš	Žalia	Verde	Zelena	Zelená
<b>GR</b>	Szürke	Szara	Γκρι	Серый	Gri	Сиво	Hall	Pelēks	Pilka	Gri	Siva	Sivá
<b>LA</b>	Levendulakék	Lawenda	Λεβάντα	Лавандовый	Lavanta	Лавандула	Lavendel	Lavanda	Lavanda	Lavandă	Sivka	Levanduľa
<b>LB</b>	Világoskék	Jasnoniebieska	Ανοικτό μπλε	Голубой	Acik mavi	Светлосиньо	Helesinine	Gaiši zils	Šviesiai mélyna	Albastru deschis	Svetlo modra	Svetlomodrá
<b>LG</b>	Világoszöld	Jasnozielona	Ανοικτό πράσινο	Светло-зелёный	Acik yesil	Светлозелено	Helerohe-line	Gaiši zaļš	Šviesiai žalia	Verde deschis	Svetlo zelena	Svetlozelená
<b>NO</b>	Természetes színű	Barwy naturalne	Φυσικά χρώματα	Телесный	Nötr	Естествен цвет	Värvitu	Dabiska krāsa	Natūrali spalva	Culoare naturală	Naravna barva	Přírodní farba
<b>O</b>	Narancs	Pomarańczowa	Πορτοκαλί	Оранжевый	Turuncu	Оранжево	Oranž	Oranžs	Oranžine	Portocaliu	Oranžna	Oranžová
<b>P</b>	Rózsaszín	Różowa	Ροζ	Розовый	Pembe	Розово	Roosa	Rozā	Rožinē	Roz	Roza	Růžová
<b>R</b>	Piros	Czerwona	Κόκκινο	Красный	Kırmızı	Червено	Punane	Sarkans	Raudona	Roșu	Rdeča	Červená
<b>PU</b>	Biborvörös	Purpurova	Πορφυρό	Пурпурный	Mor	Пурпурно	Tume-punane	Purpursarkans	Purpuriné	Mov	Škrlatna	Purpurová
<b>SB</b>	Égyszínű	Bękitna	Γαλάζιο	Небесно-голубой	Gök mavisi	Небесносиньо	Taevasinine	Debeszils	Žydra	Azuriu	Nebesno modra	Azúrová
<b>T</b>	Sárgásbarna	Żółto-brązowa	Κητρινοκαφέ	Жёлто-коричневый	Sarı kahverengi	Жълтокафяво	Kollane-pruun	Dzeltenbrūns	Gelsvai ruda	Galben-marro	Rumeno-java	Žltohnědá
<b>W</b>	Fehér	Biała	Λευκό	Белый	Beyaz	Бяло	Valge	Balts	Balta	Alb	Bela	Biela
<b>Y</b>	Sárga	Żółta	Κίτρινο	Жёлтый	Sarı	Жълто	Kollane	Dzeltens	Geltona	Galben	Rumena	Žitá
<b>V</b>	Ibolyakék	Fioletowa	Μοβν	Фиолетовый	Menekşe	Виолетово	Lilla	Violet	Violetinē	Violet	Vijolična	Fialová

# Revision record









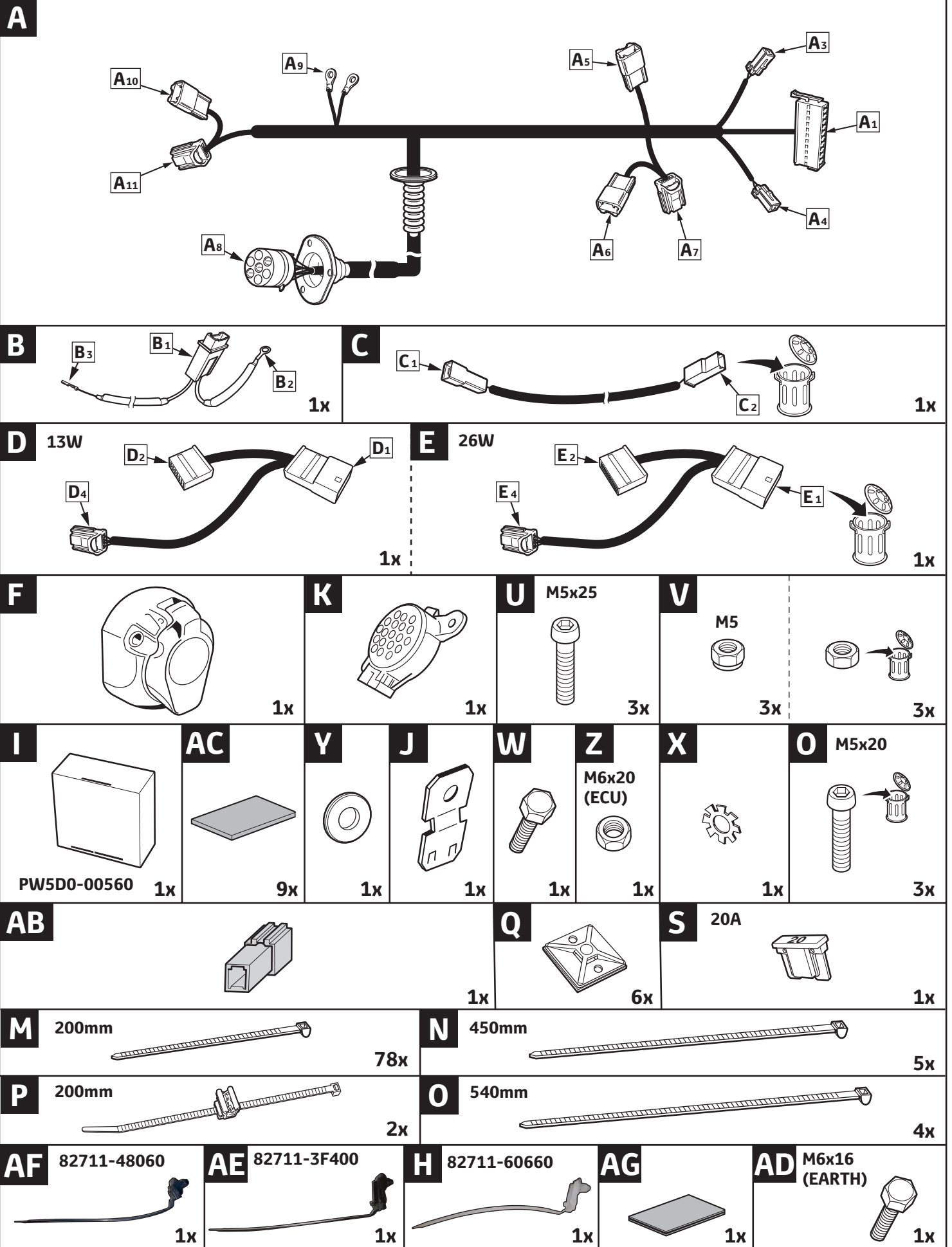

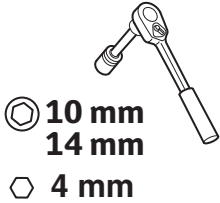

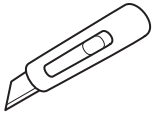
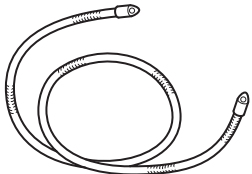
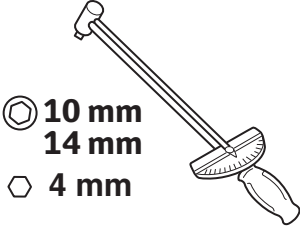
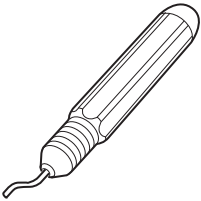
Rev. No.	Date	Page	Step	Remarks
△ <sub>1</sub>	17.04.2019	20, 29, 33	13, 23, 28	Delta „S“ added fuses, adapter
△ <sub>1</sub>	17.04.2019	35-37	CS	Updated
△ <sub>1</sub>	17.04.2019	39		Adapter page added
△ <sub>2</sub>	27.05.2019	15, 18, 23, 33, 34	8, 11, 17, CS	Torque update
△ <sub>2</sub>	27.05.2019	35	CS	Check added

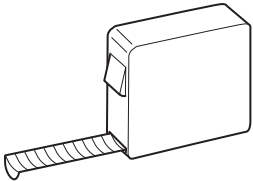
# PW5D0-02562 (13 Pin)

<b>A</b>						1x
<b>B</b>			<b>C</b>			1x
<b>D</b> 13W			<b>E</b> 26W			1x
<b>F</b>	<b>G</b>	<b>H</b> 82711-60660	<b>I</b> PW5D0-00560	<b>J</b>	<b>K</b>	<b>L</b>
<b>M</b> 200mm	<b>N</b> 450mm		<b>Q</b>	<b>R</b> 15A	<b>S</b> 20A	<b>T</b> 1A
<b>O</b> M5x20	<b>P</b> 200mm		<b>U</b> M5x25	<b>V</b> M5	<b>W</b> M6x20 (ECU)	<b>X</b>
<b>Y</b>	<b>Z</b> M6	<b>AB</b> 3W	<b>AC</b>	<b>AD</b> M6x16 (EARTH)		
<b>AE</b> 82711-3F400	<b>AF</b> 82711-48060	<b>AG</b>	<b>AH</b>			

# PW5D0-02563 (7 Pin)

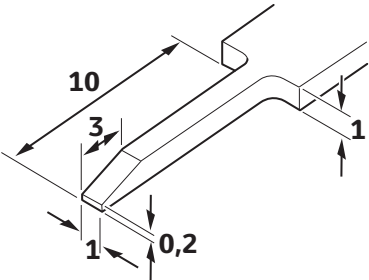
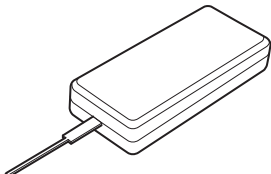

 <p>10 mm 14 mm 4 mm</p>			
 <p>10 mm 14 mm 4 mm</p>			
	 <p>CAVITY WAX</p>	 <p>Soap</p>	
 <p>PVC - Tape</p>		 <p>Masking - Tape</p>	
 <p>DEGREASER CLEANER</p> <p> AIM 003-516-*</p>		<p>Reference:</p>  <p>(mm) PZ415-0JGB9-00</p> 	
<p><b>INFORMATION</b></p>			
 <p><b>Material Safety Data Sheet</b></p>		 <p><b>Technical Data Sheet</b></p>	



# WIRE HARNESS OVERVIEW

2.0

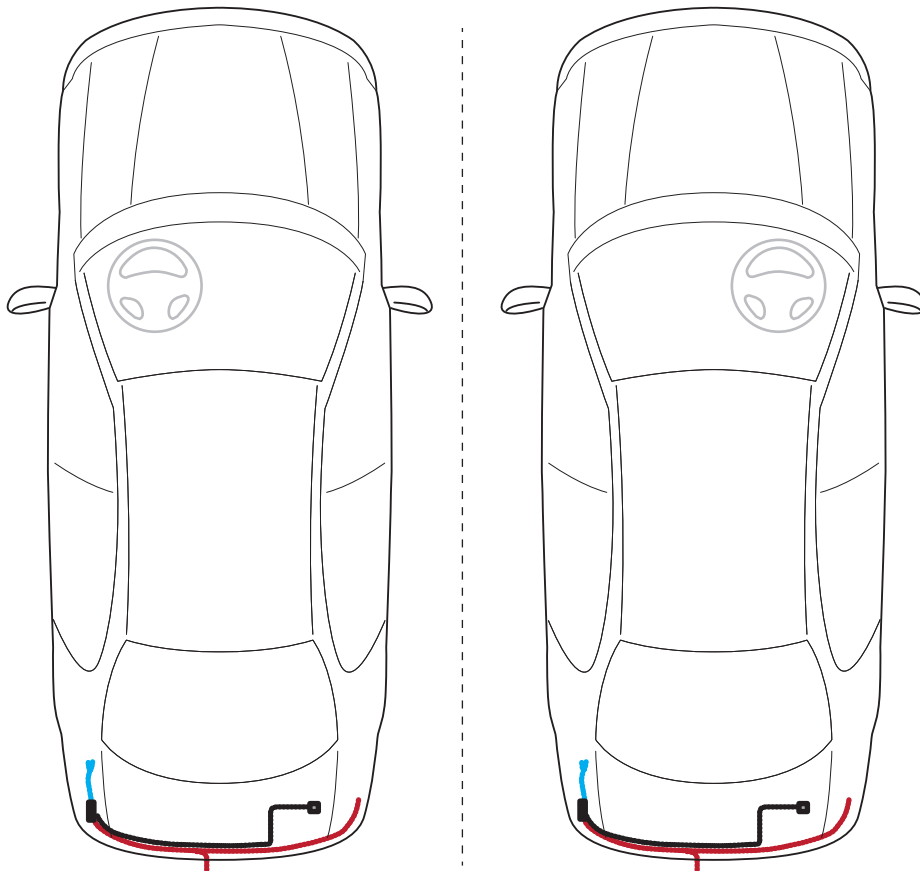

=  XX mm	=	=
=  XX mm	=	=
=	=	=
=  TXX	=	= START

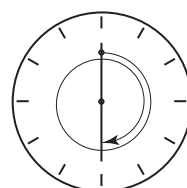
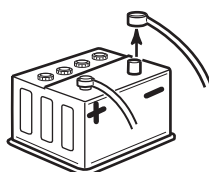
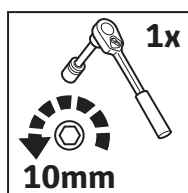

90 sec



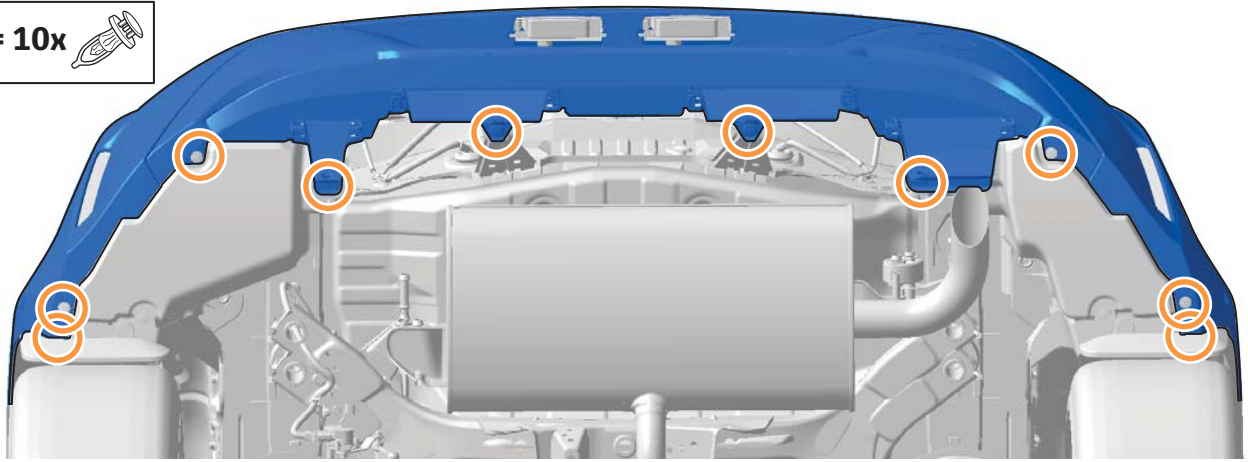

1

○ = 10x 



2

②  
⬡ = 2x  10 mm

①  = 7x

LHS=RHS

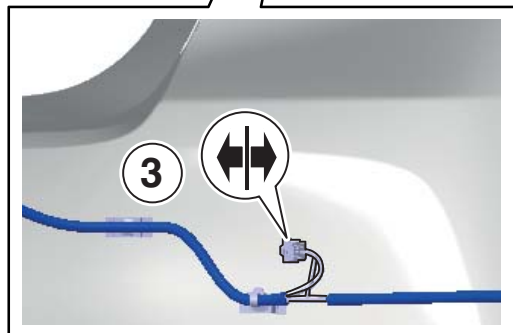
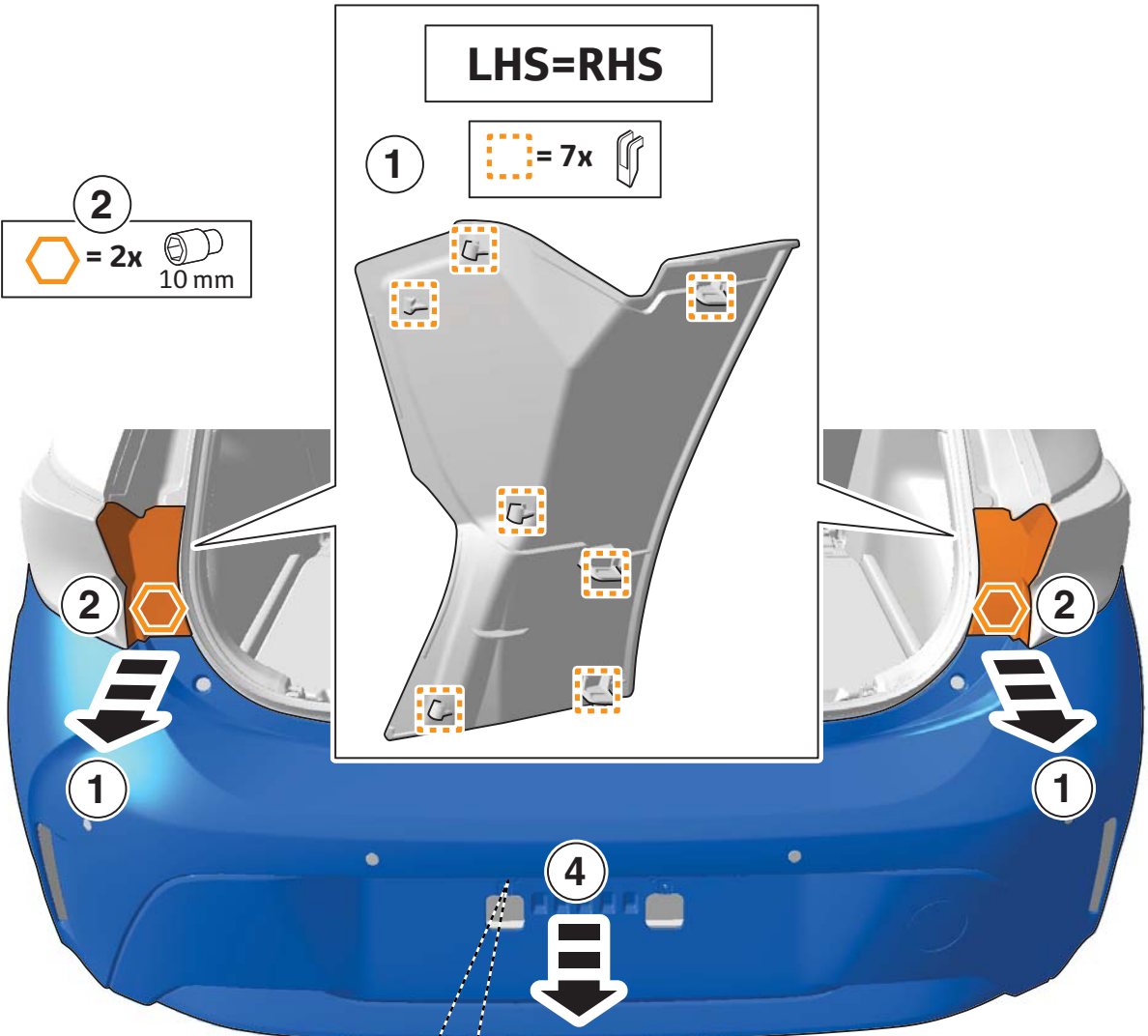

3

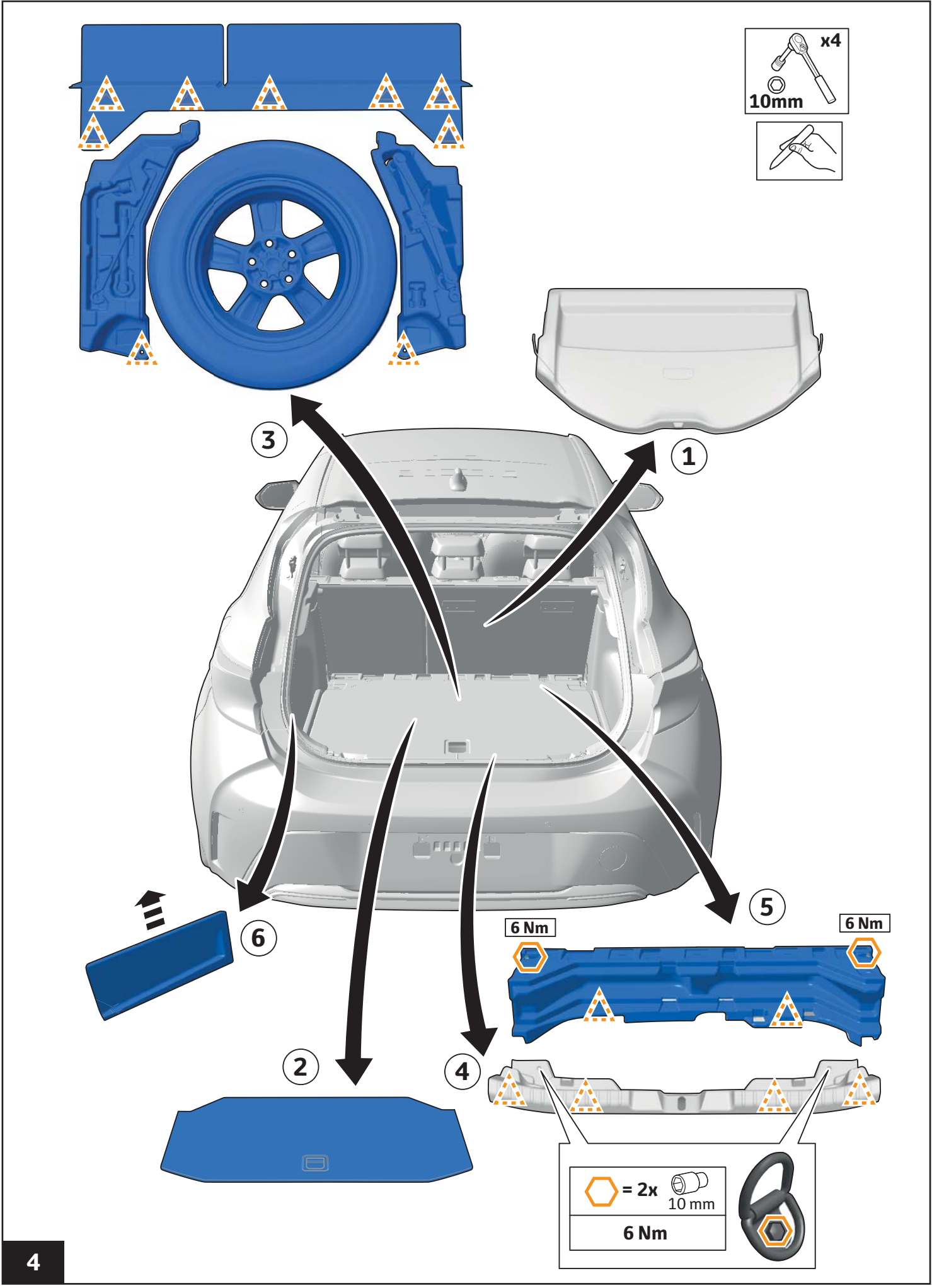

LHS=RHS

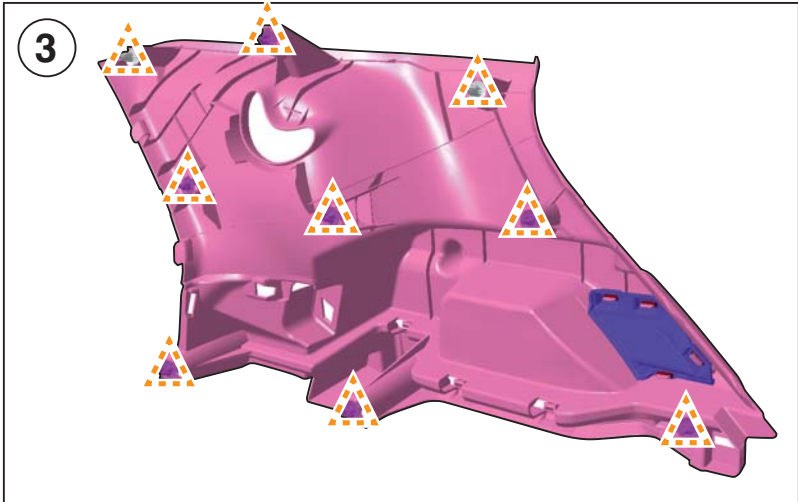

= 9x

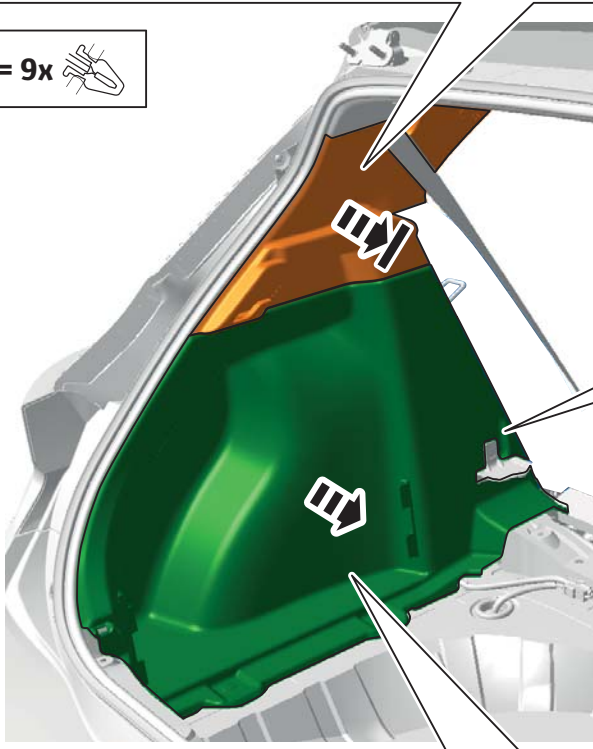

1

= 1x 10 mm

6 Nm

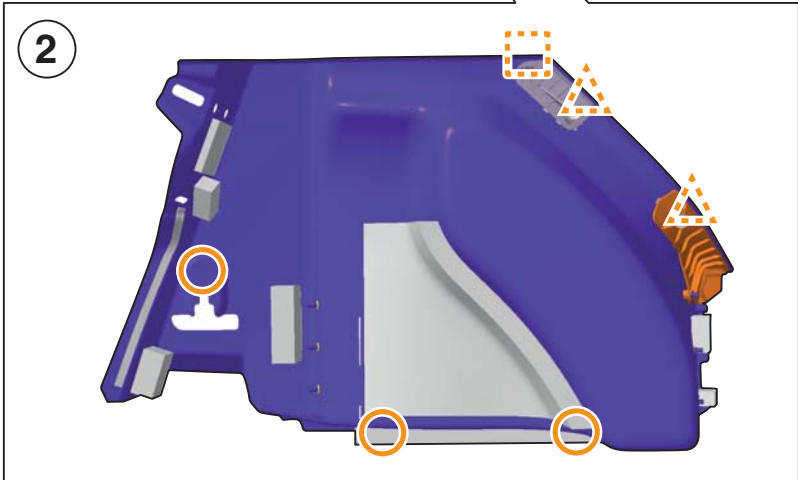

= 2x

= 1x

= 3x

5

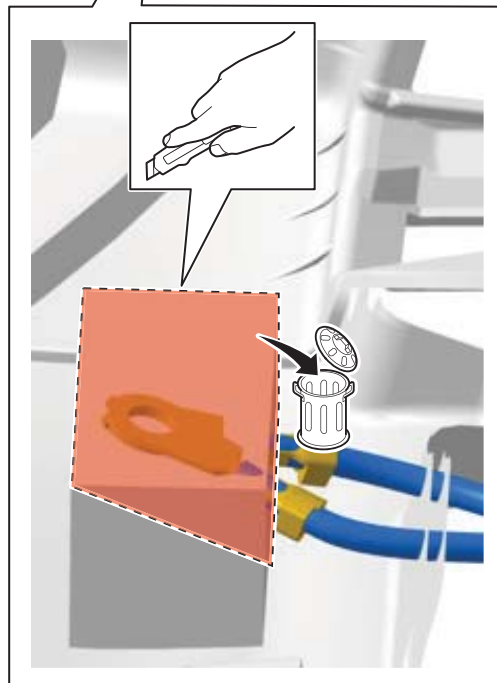
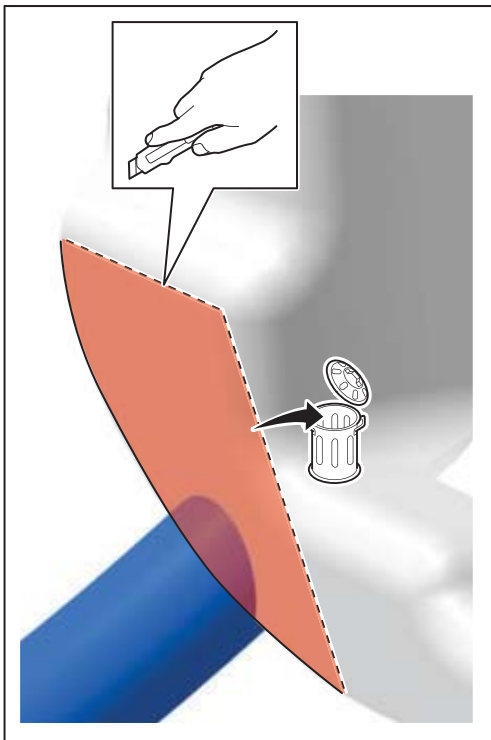
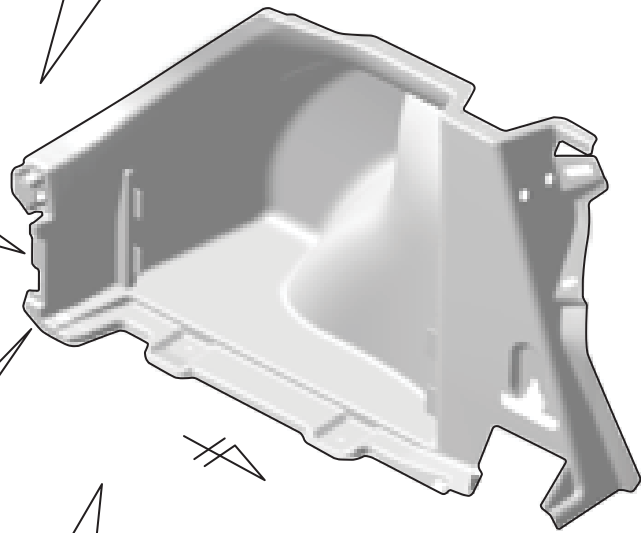
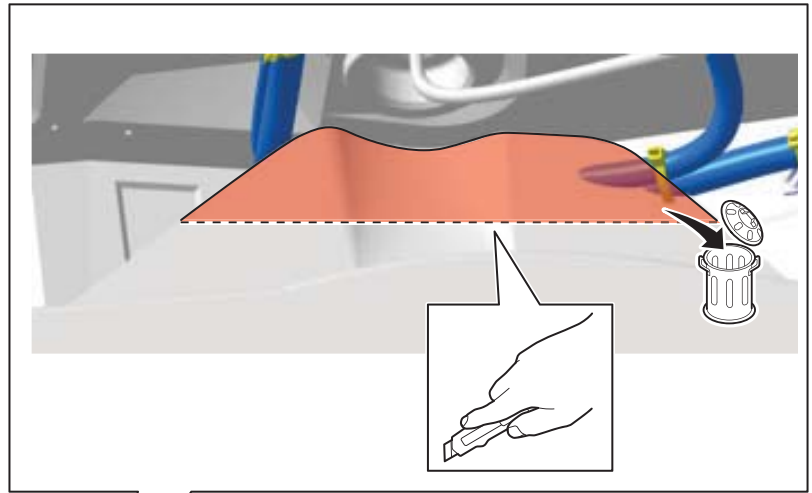
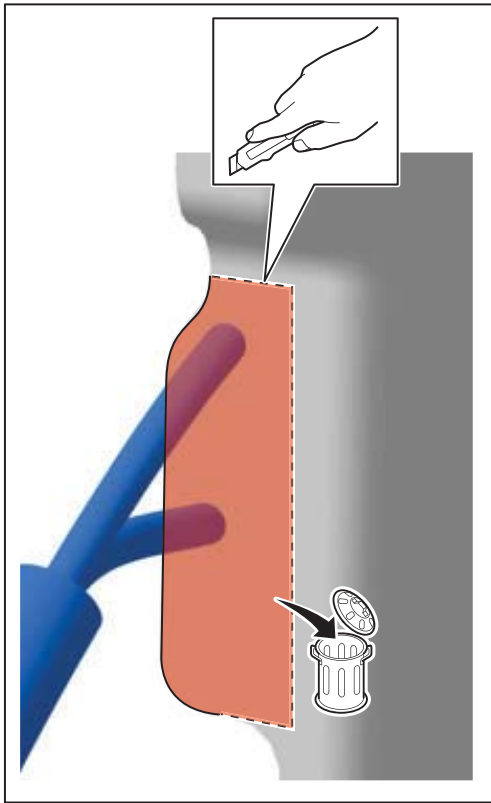

6

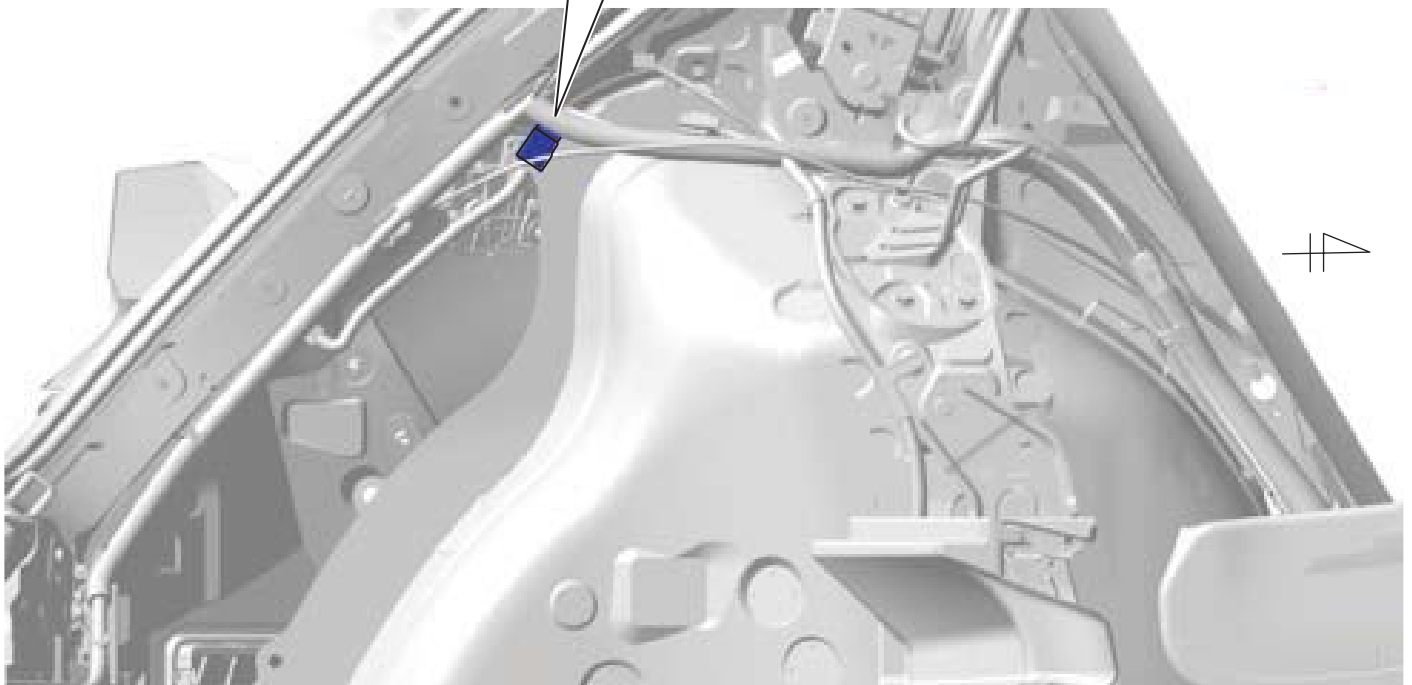
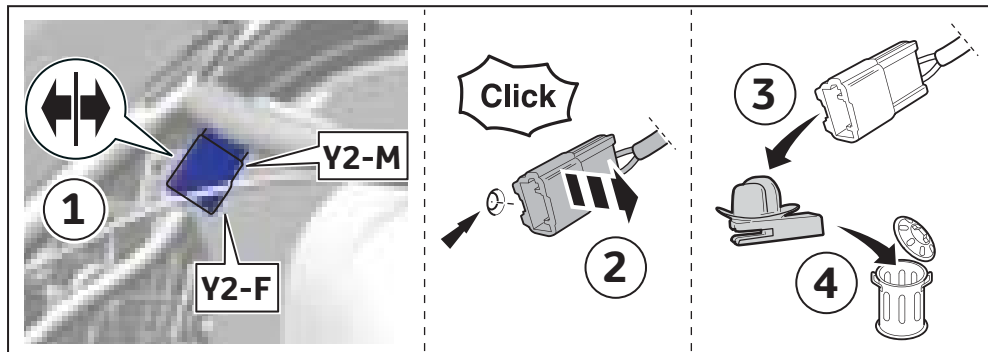
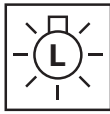
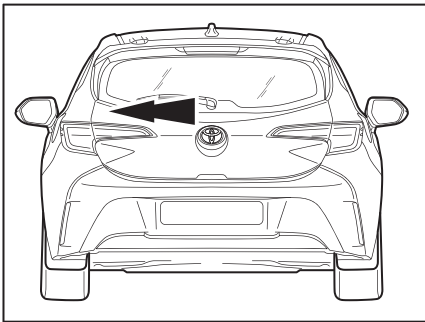



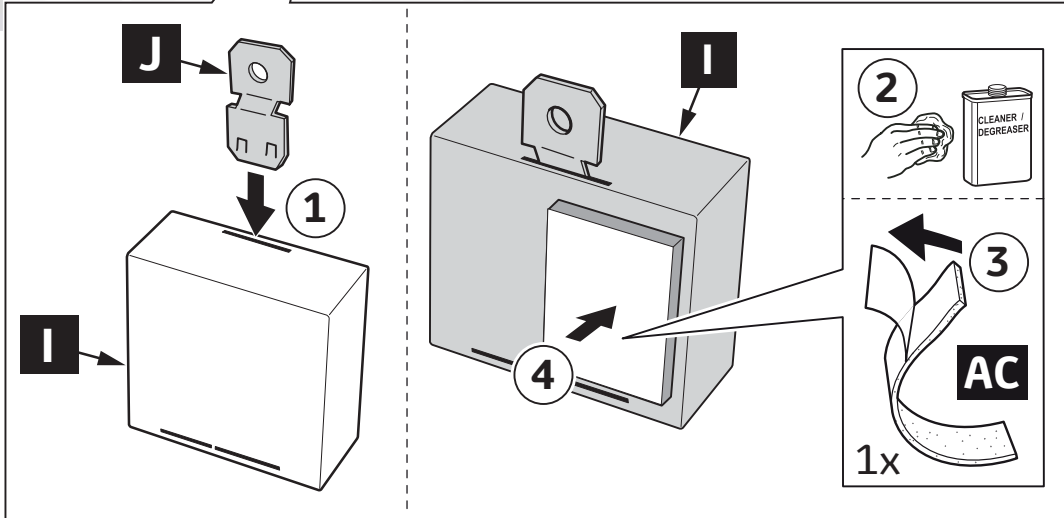
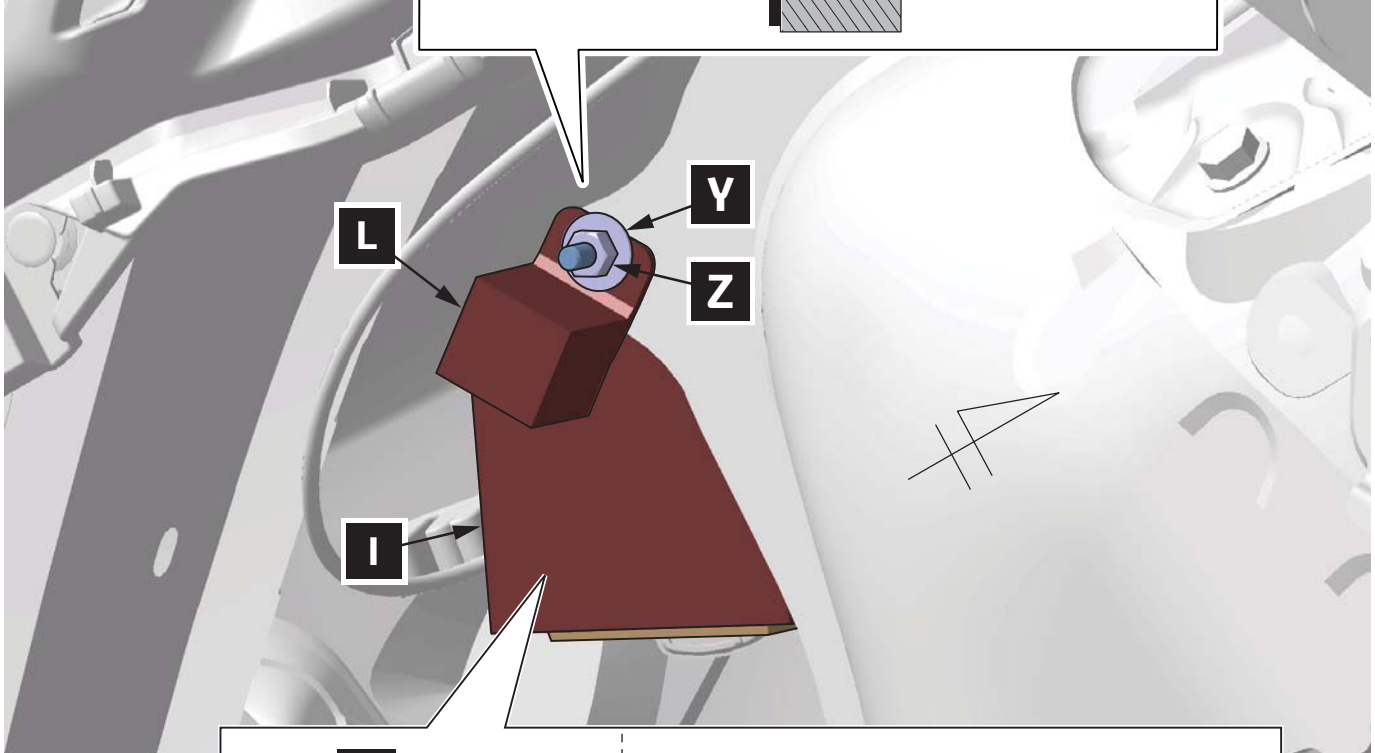
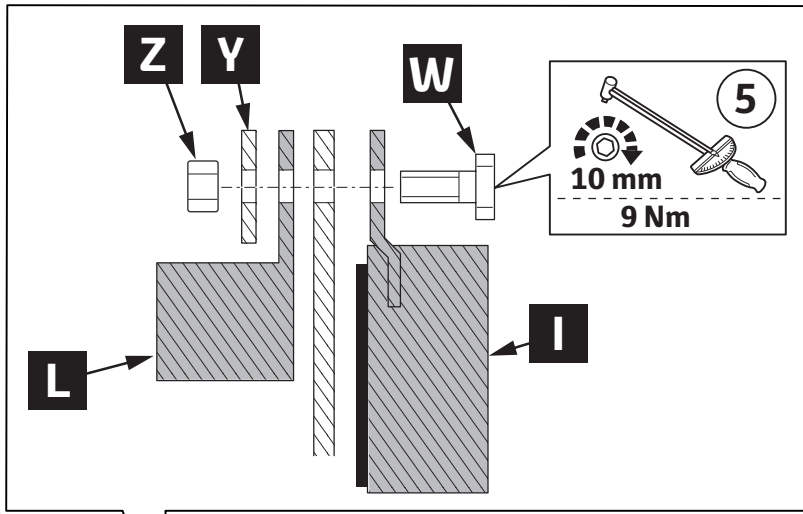
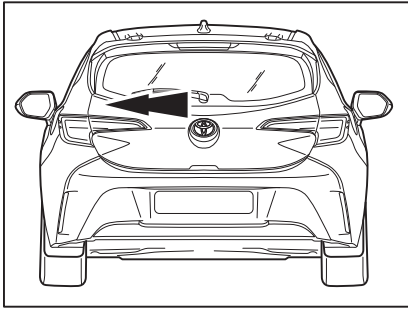

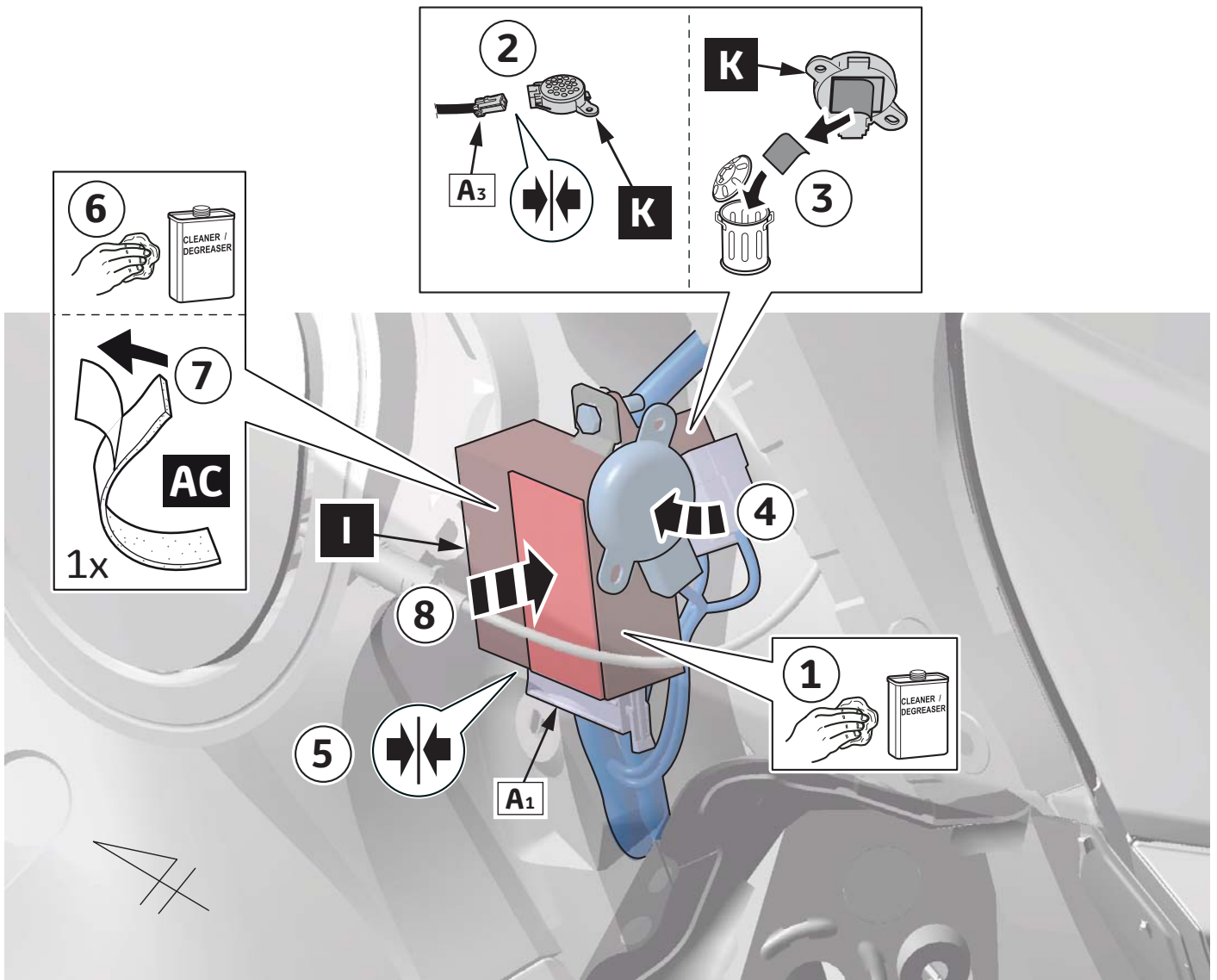



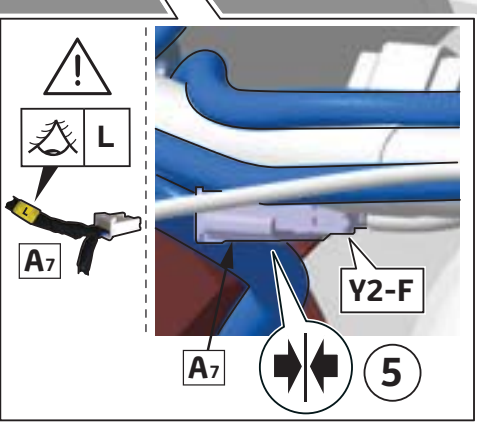
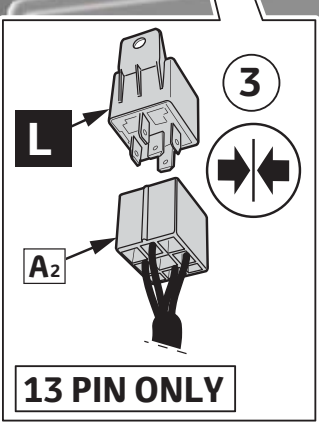
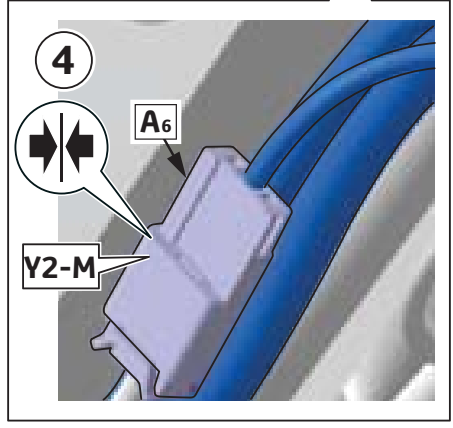
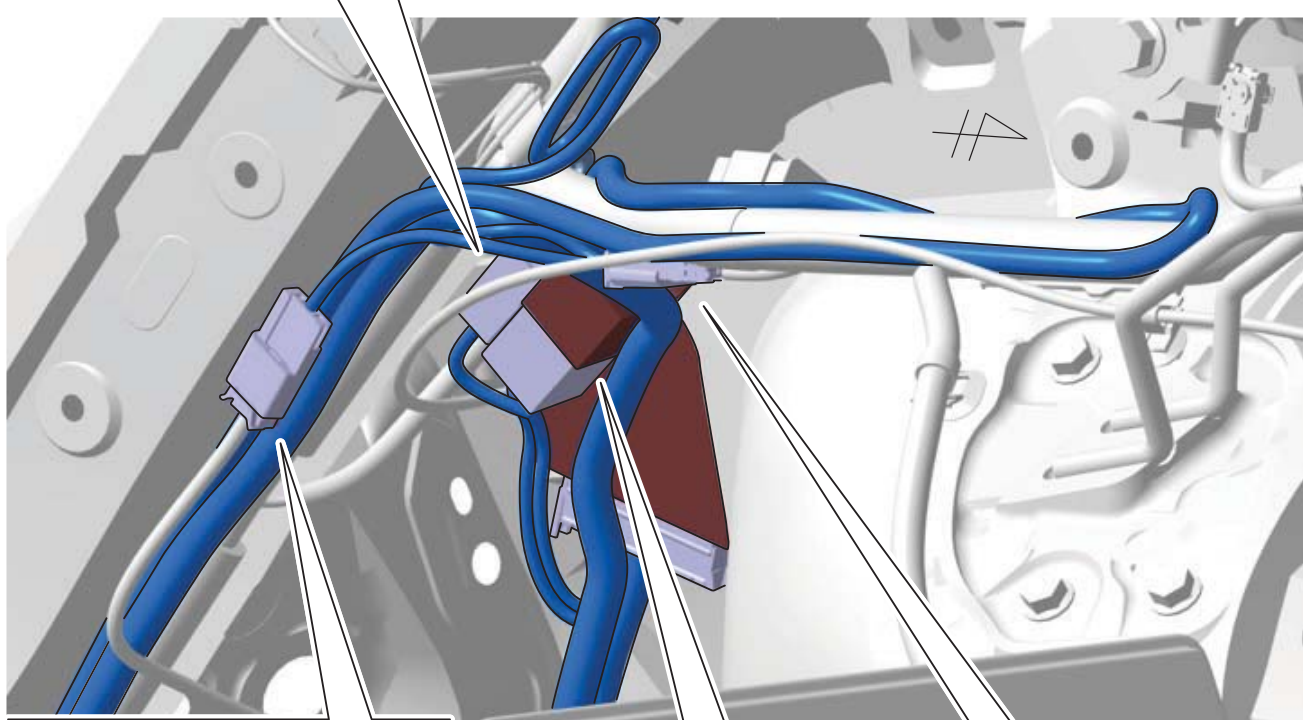
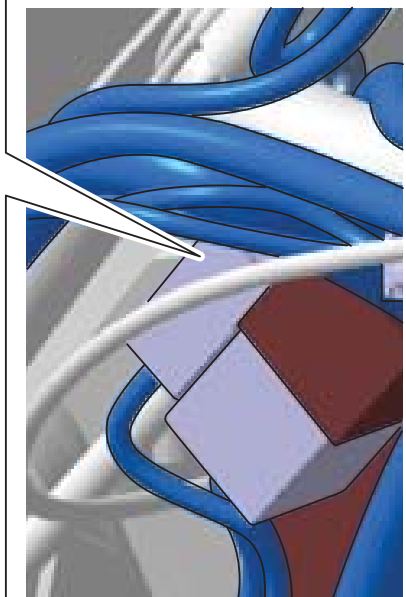
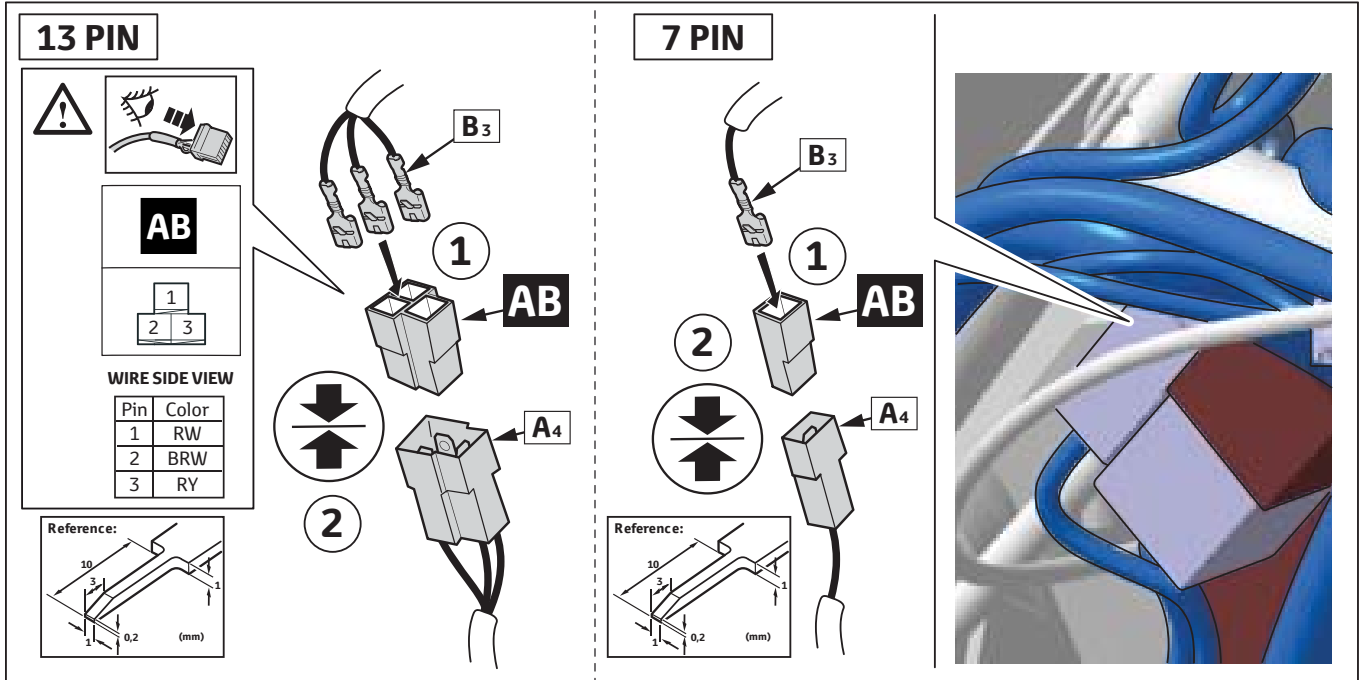

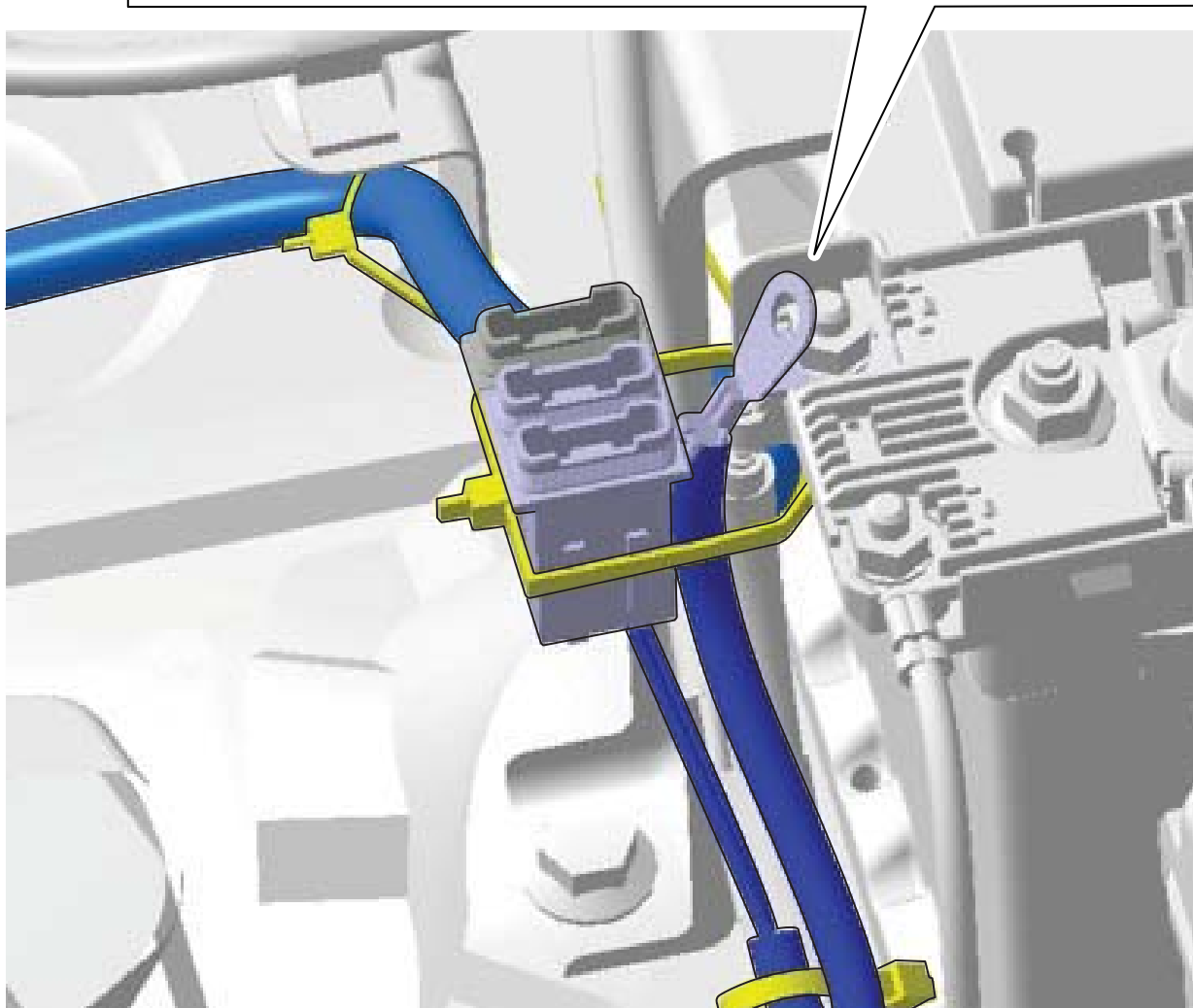
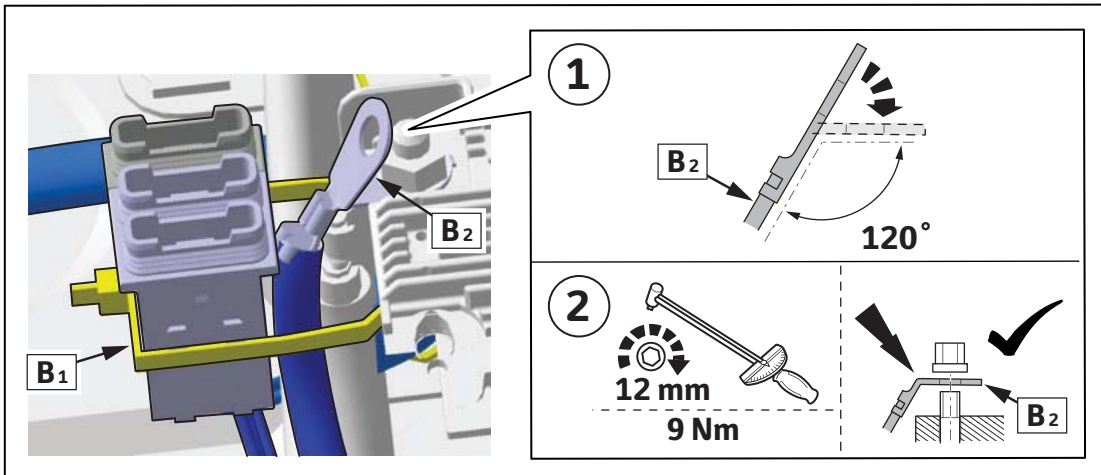

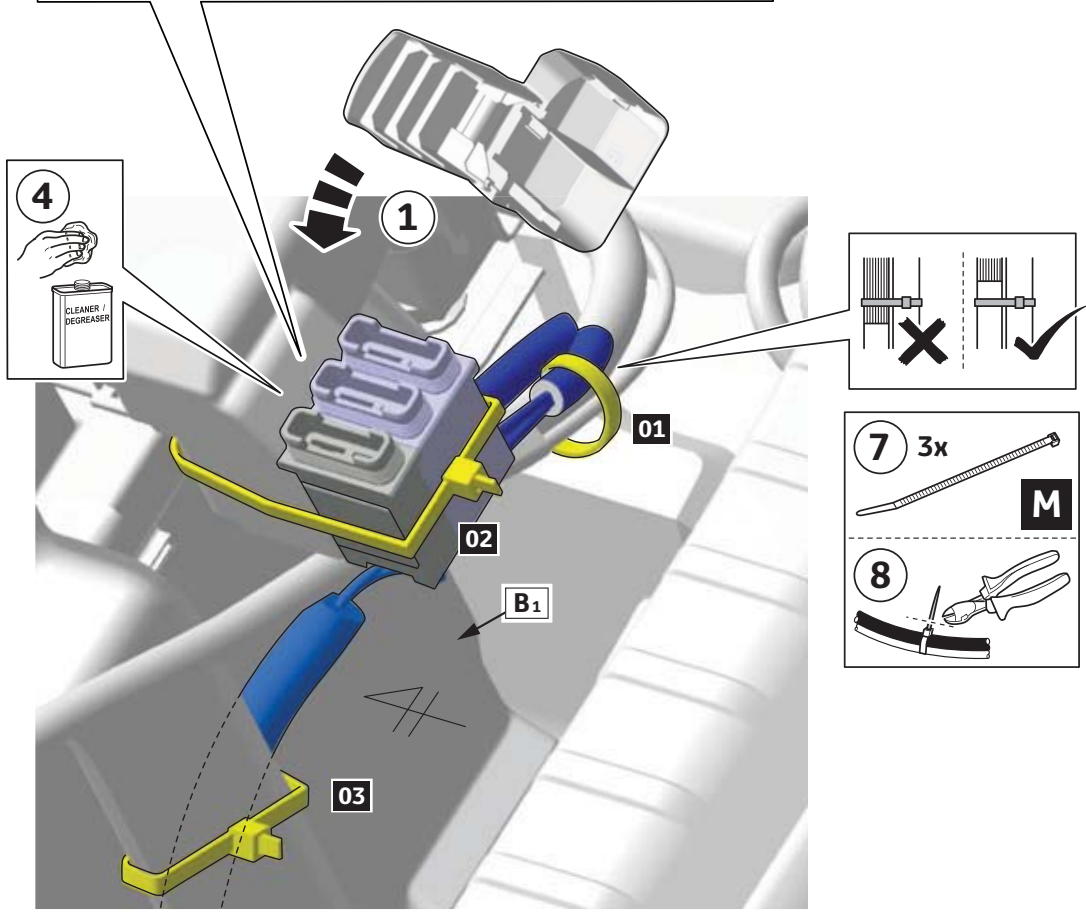
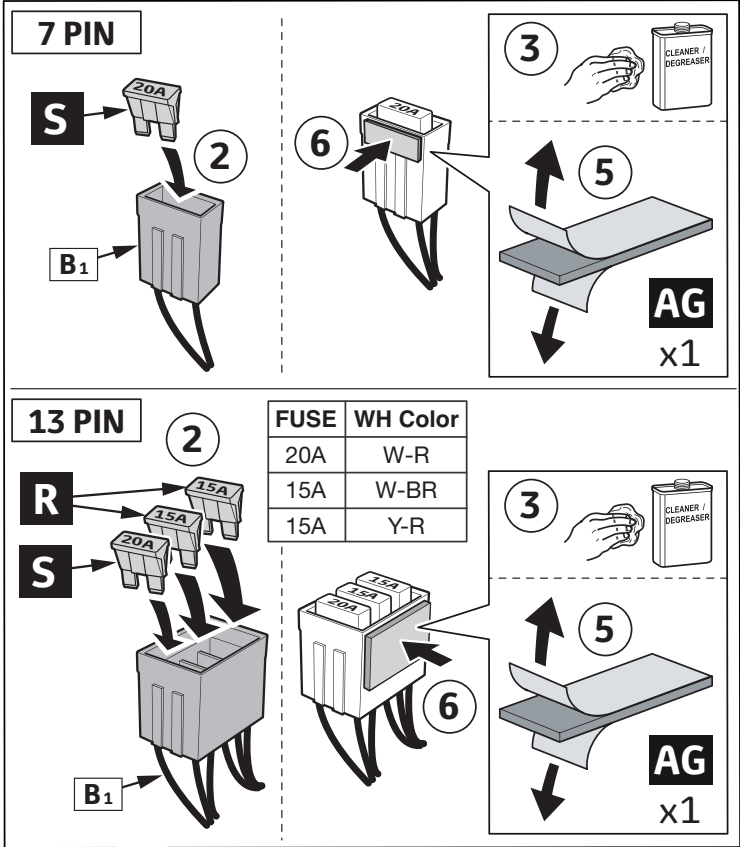

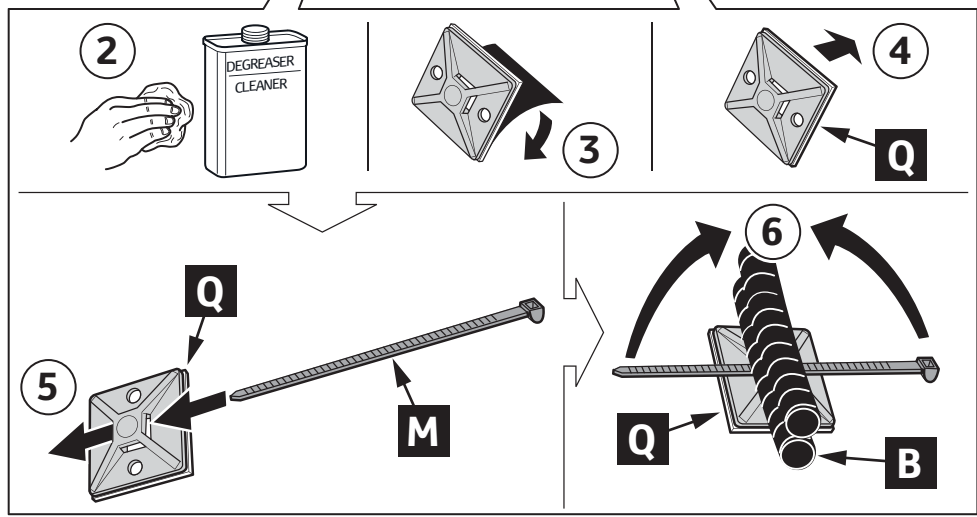
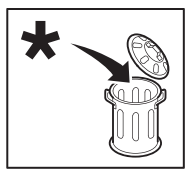

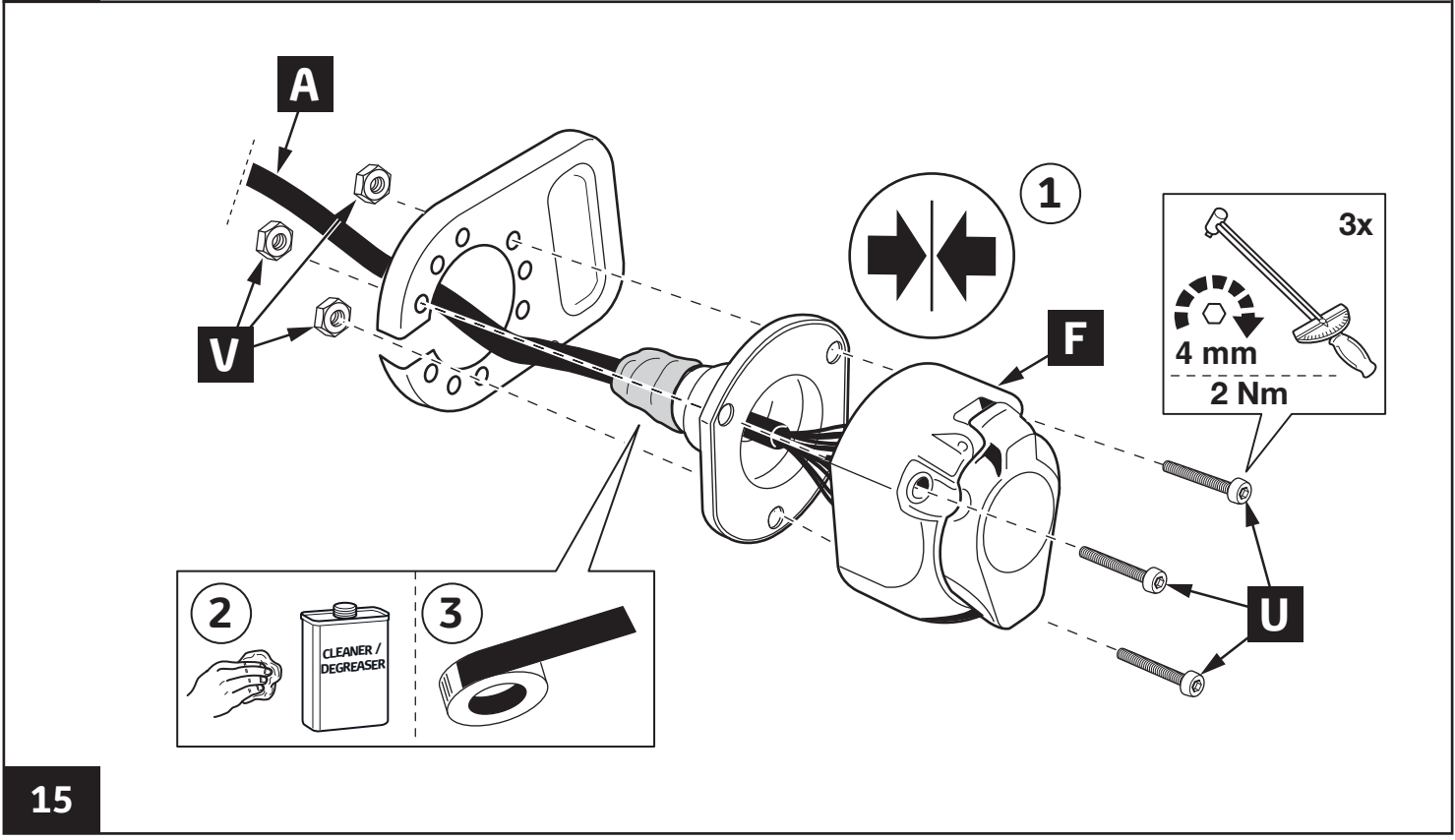
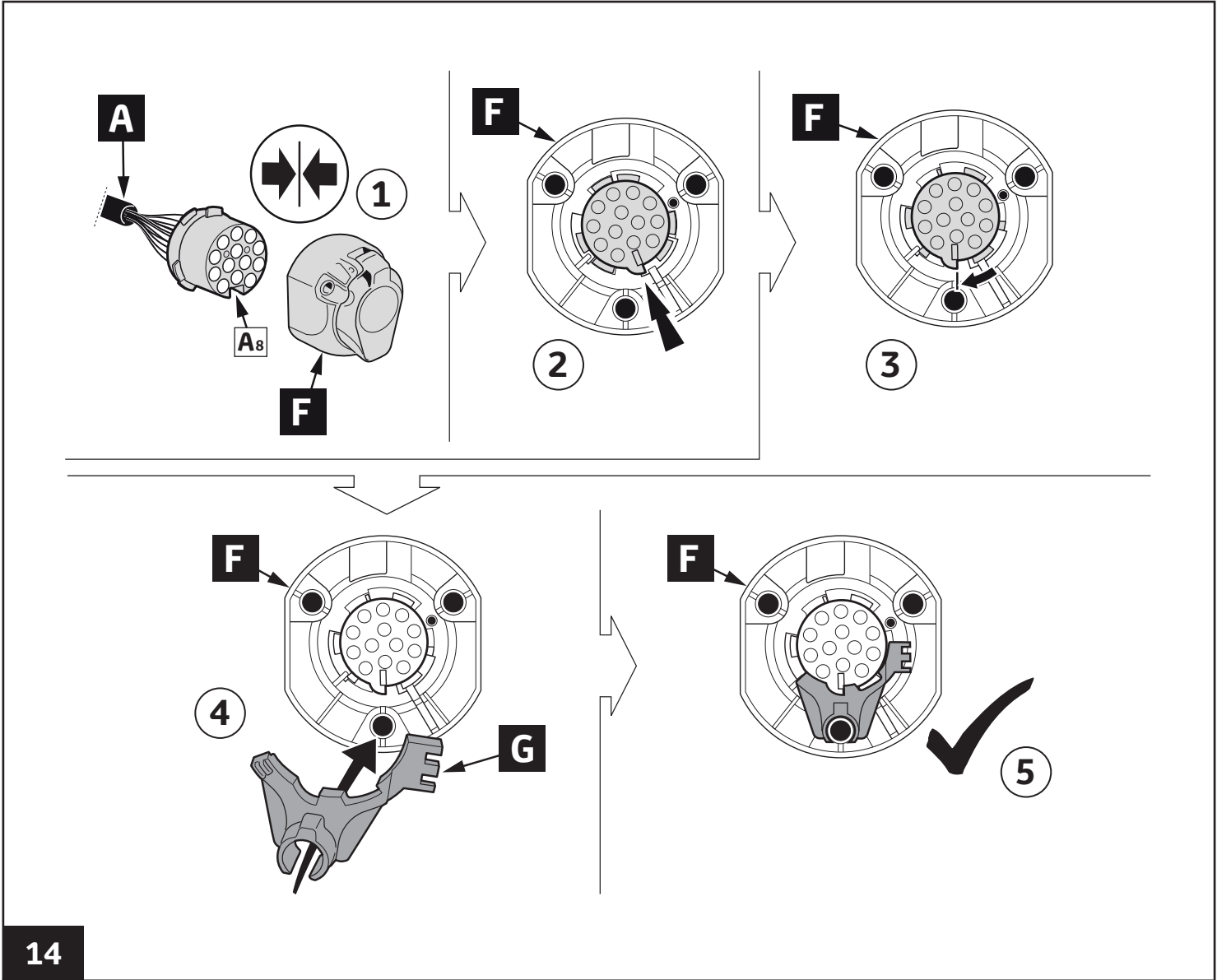

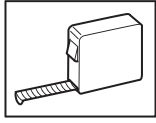

440mm

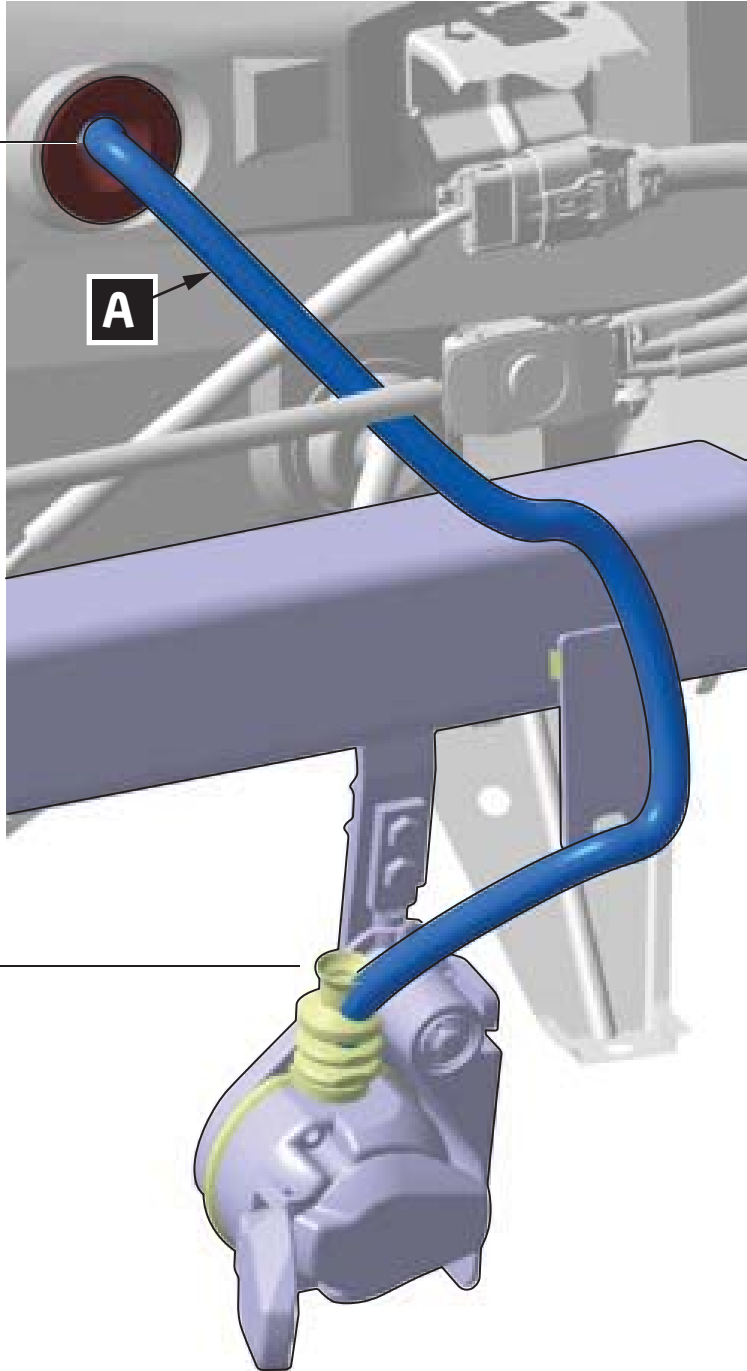



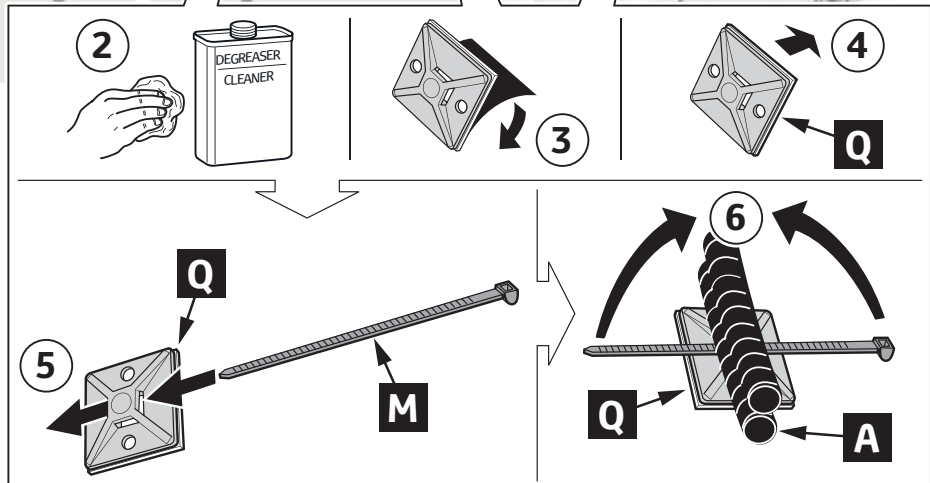
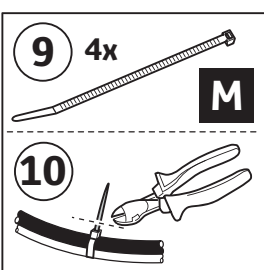
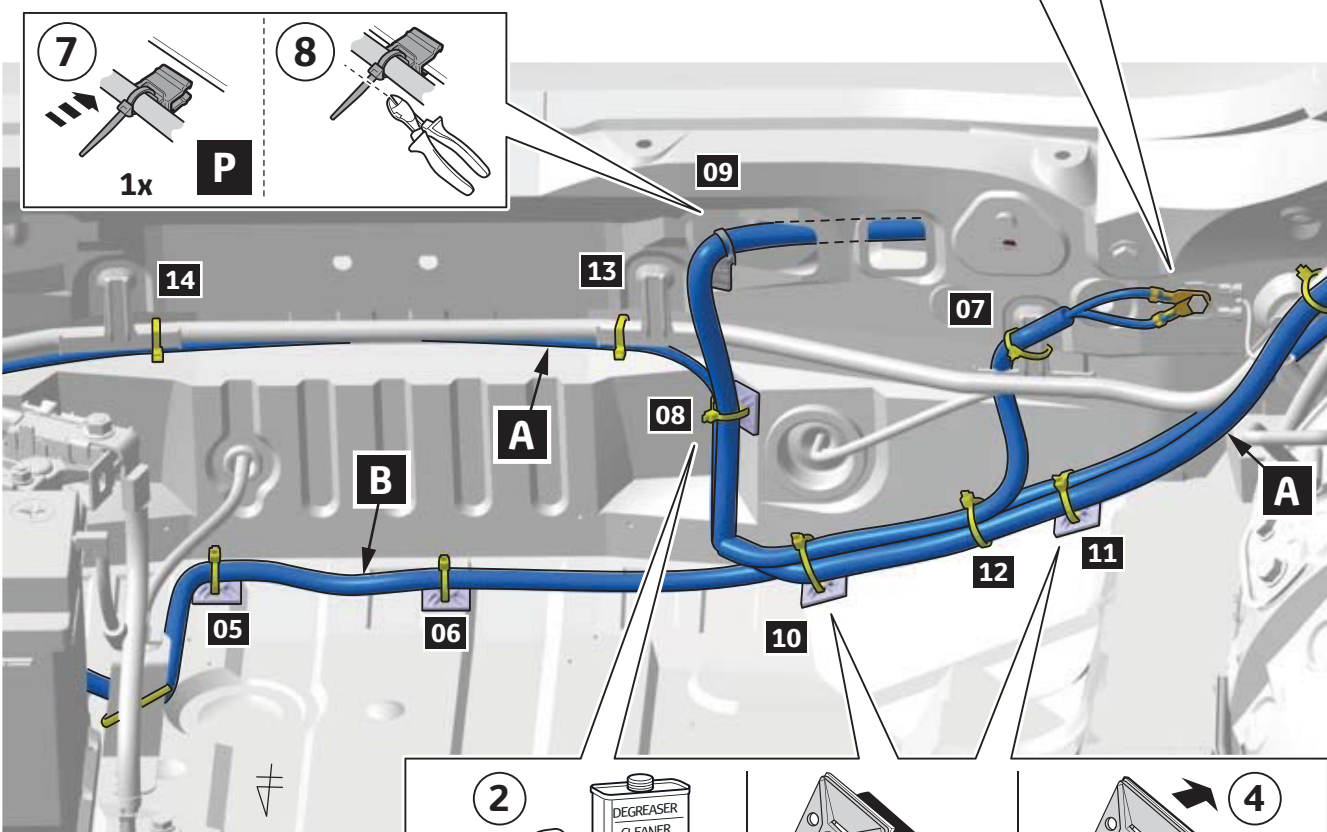
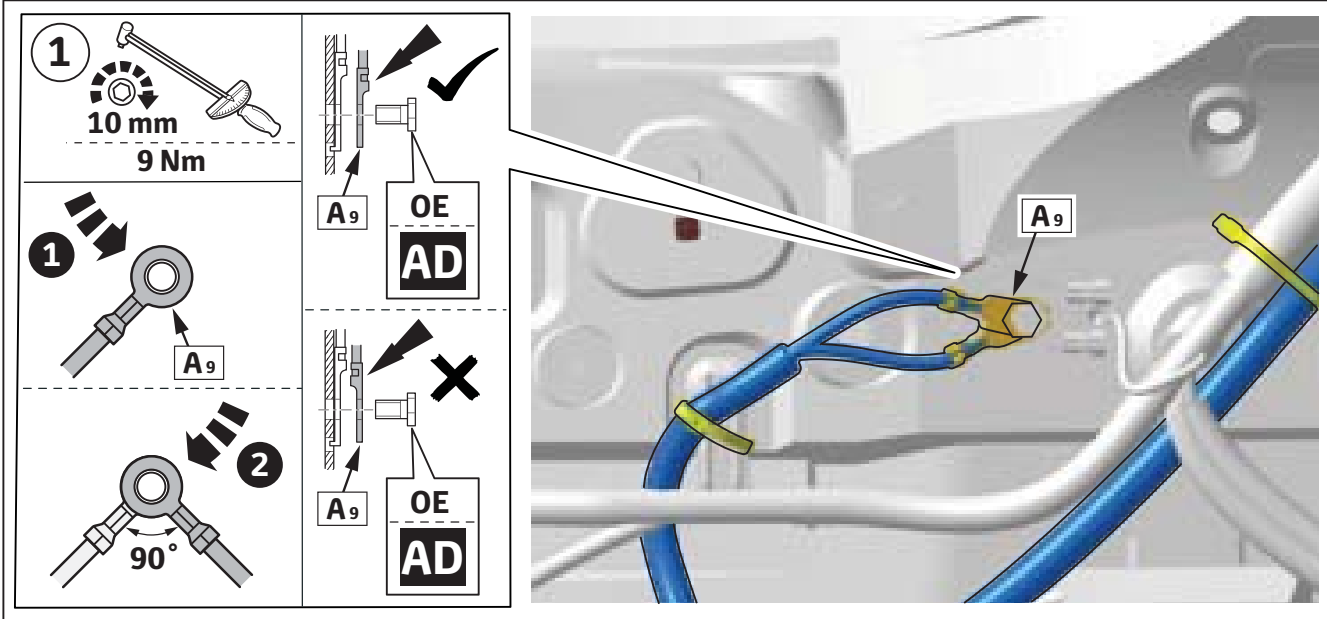

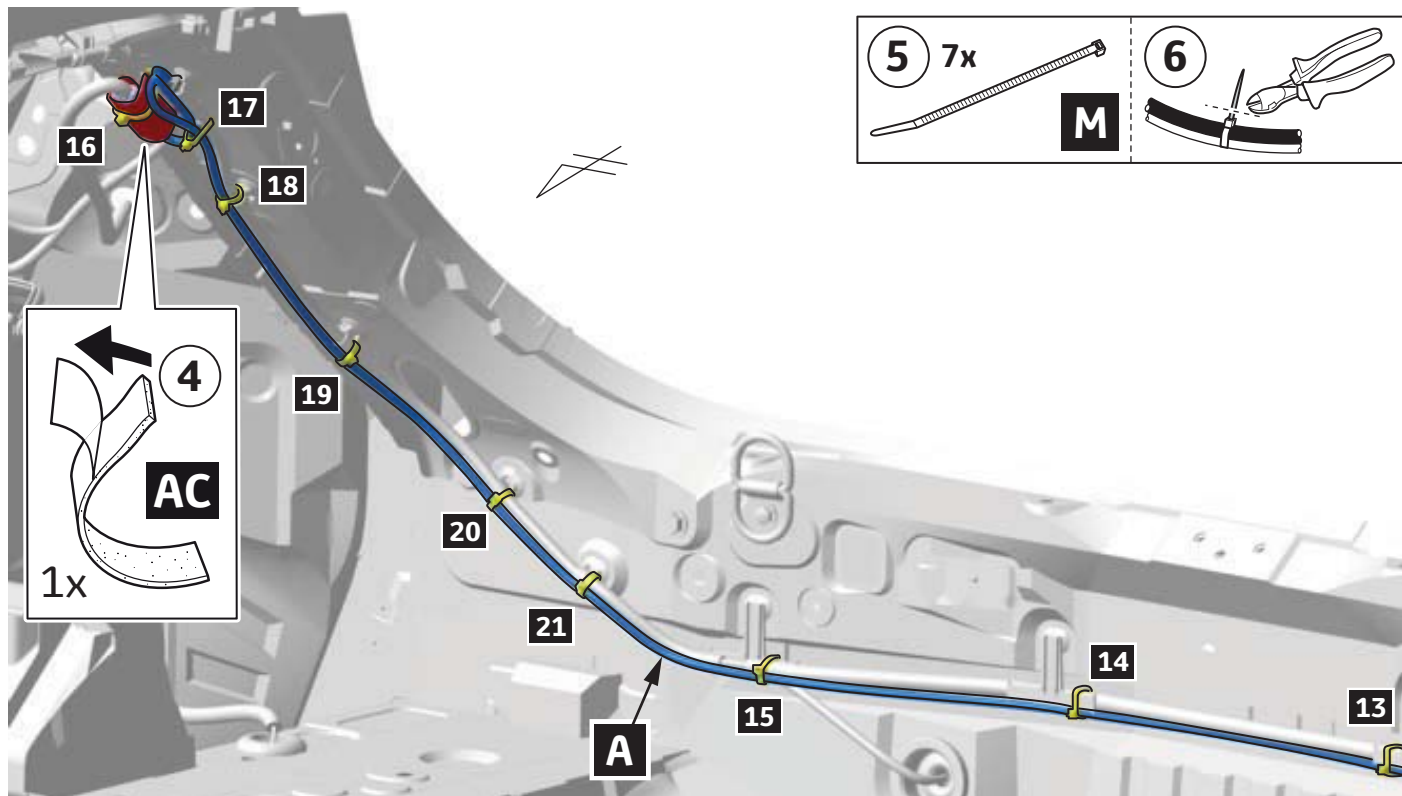
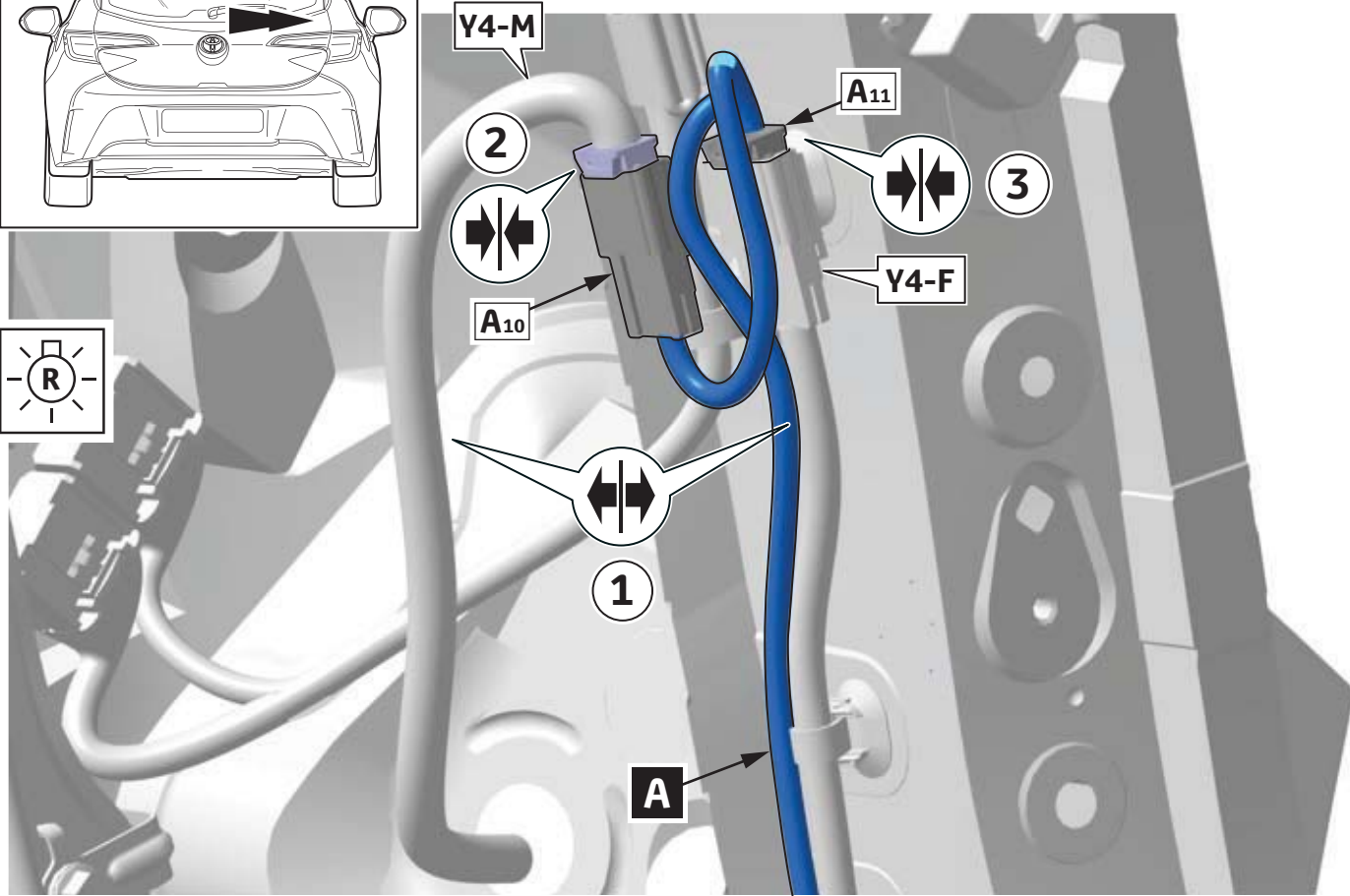
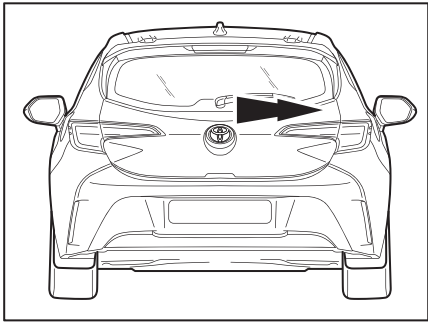

18



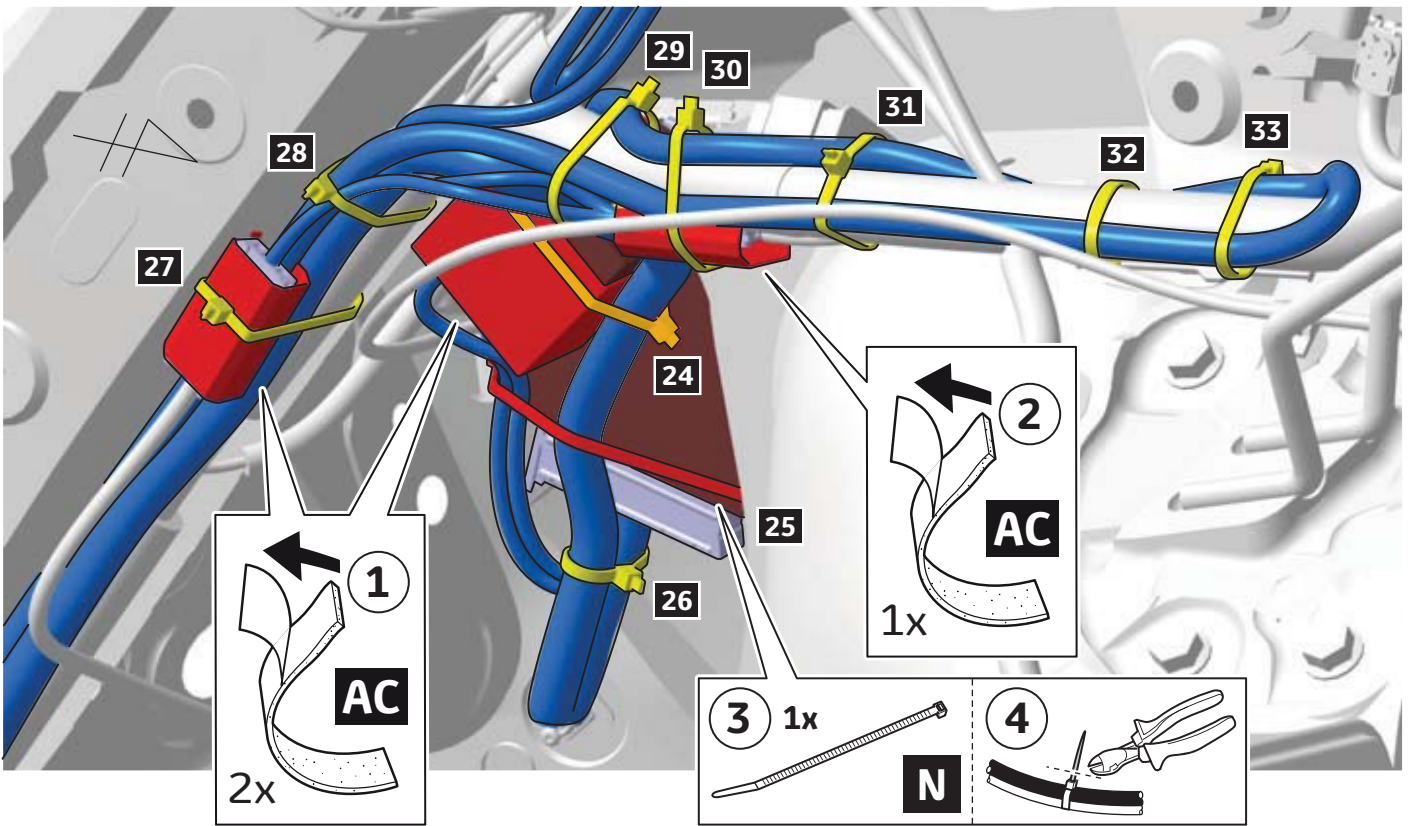
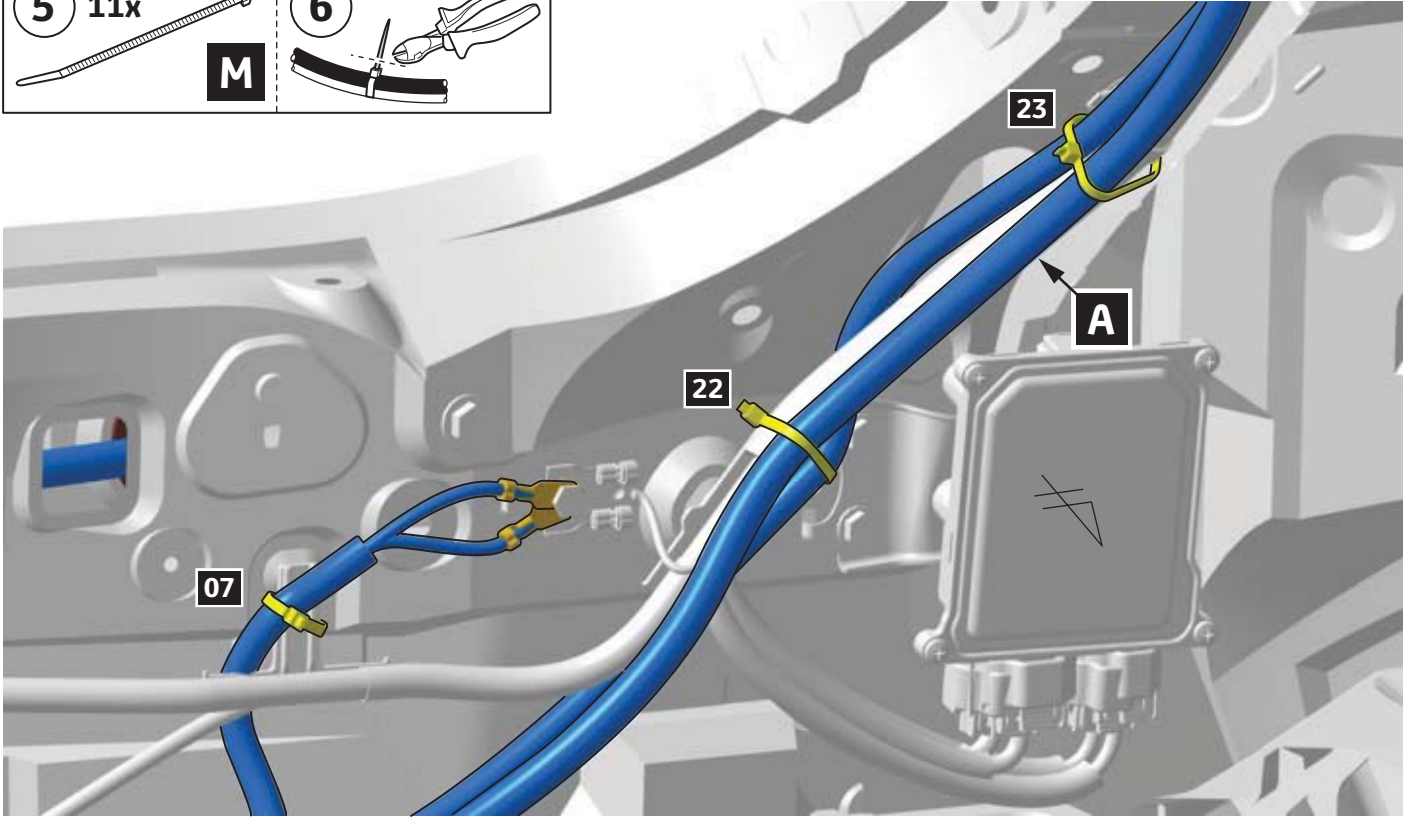
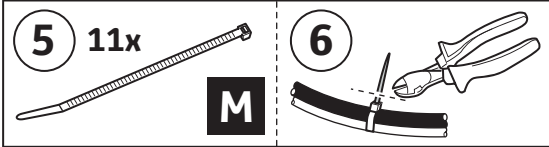

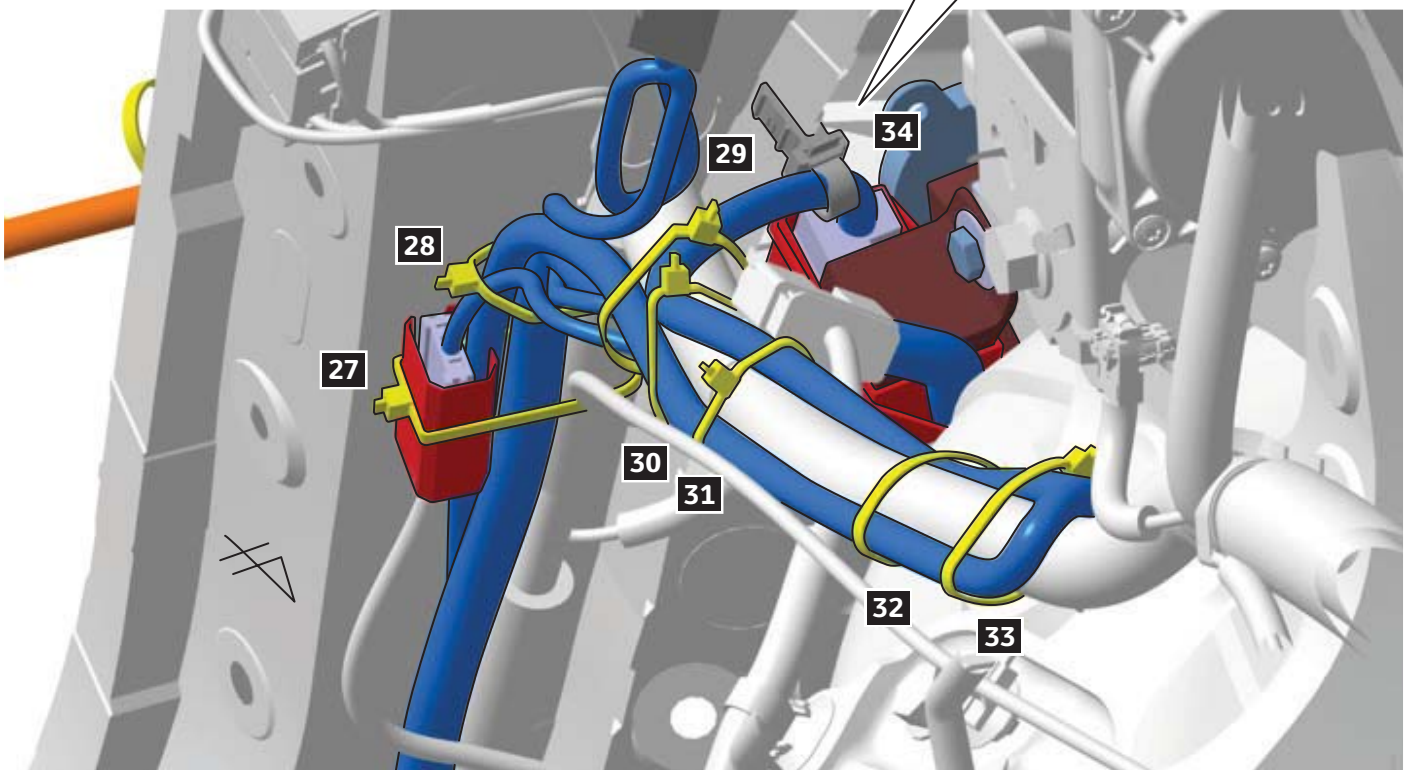
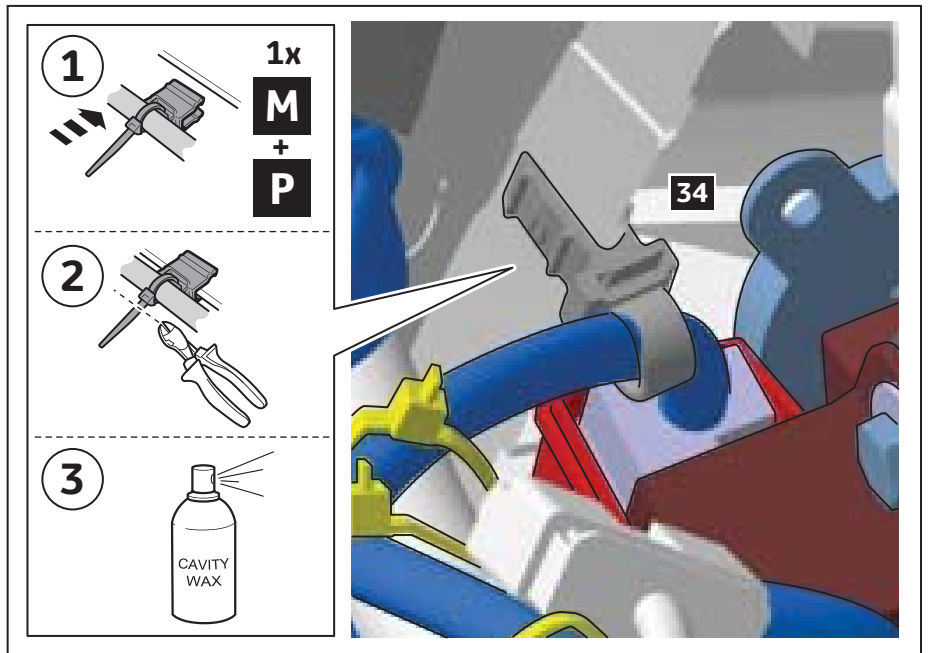

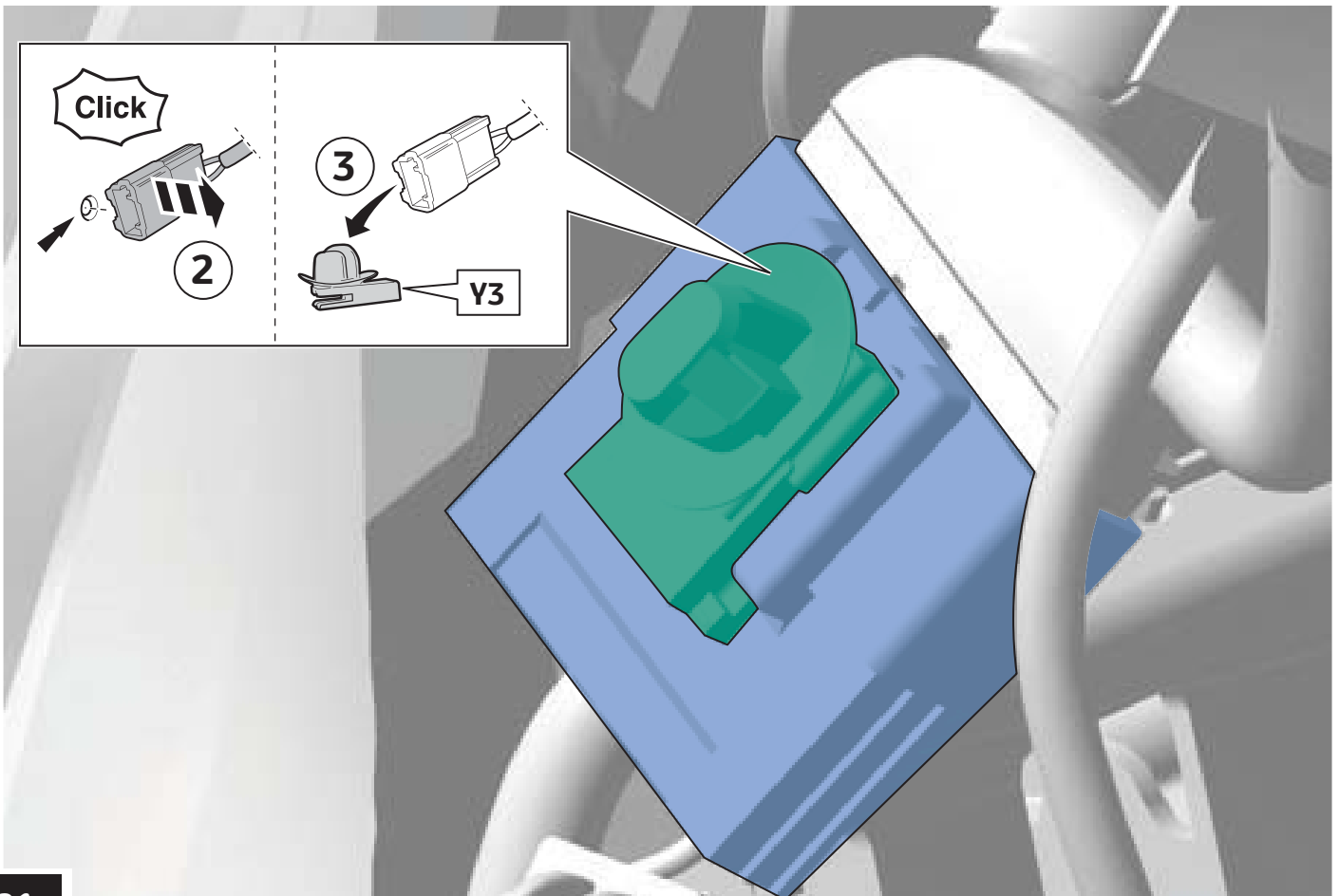
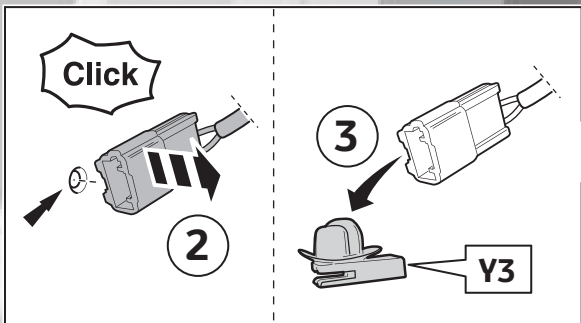
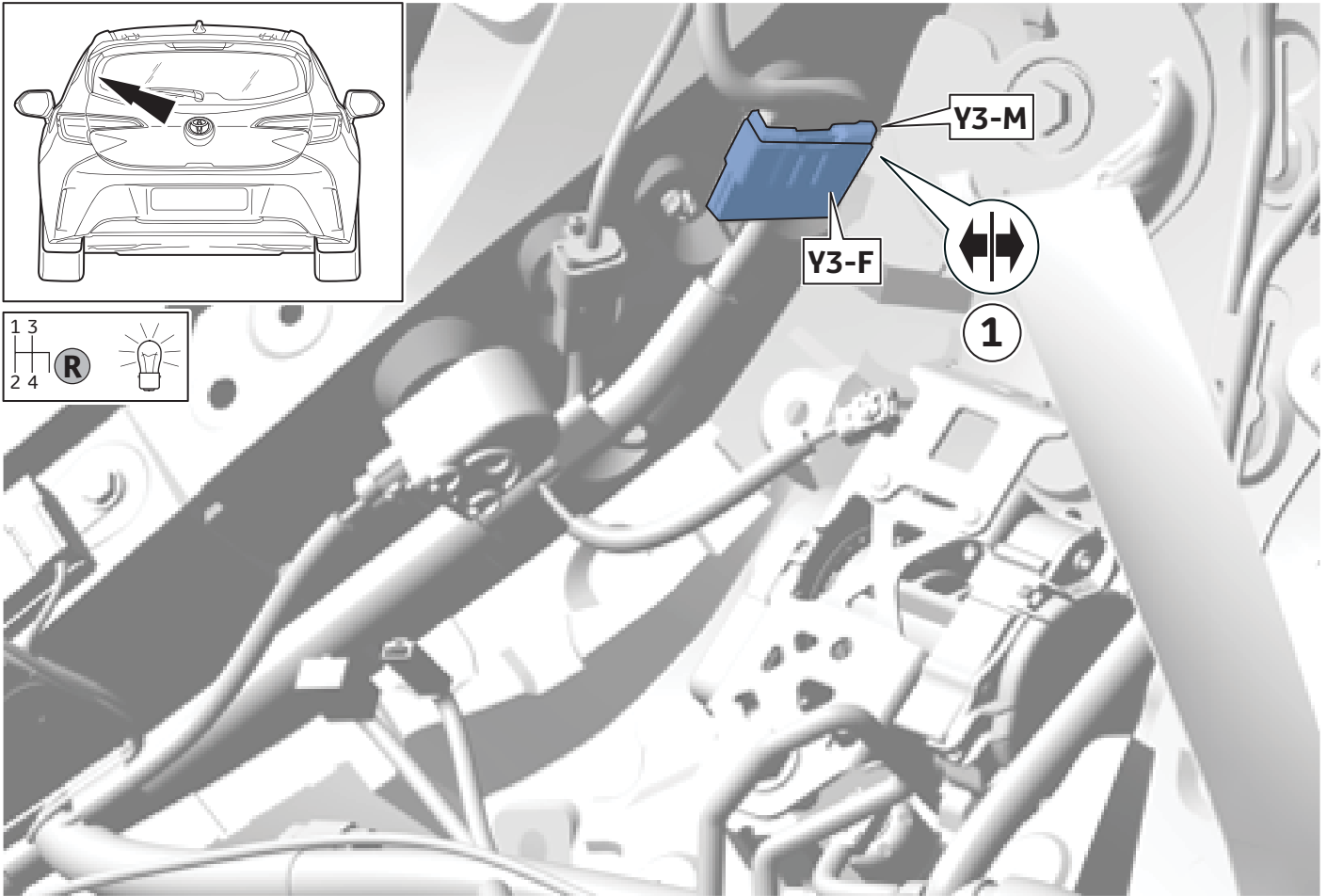
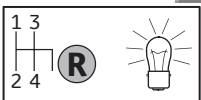
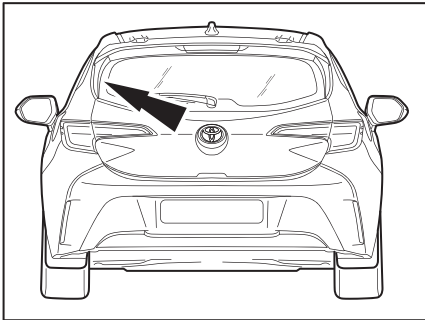

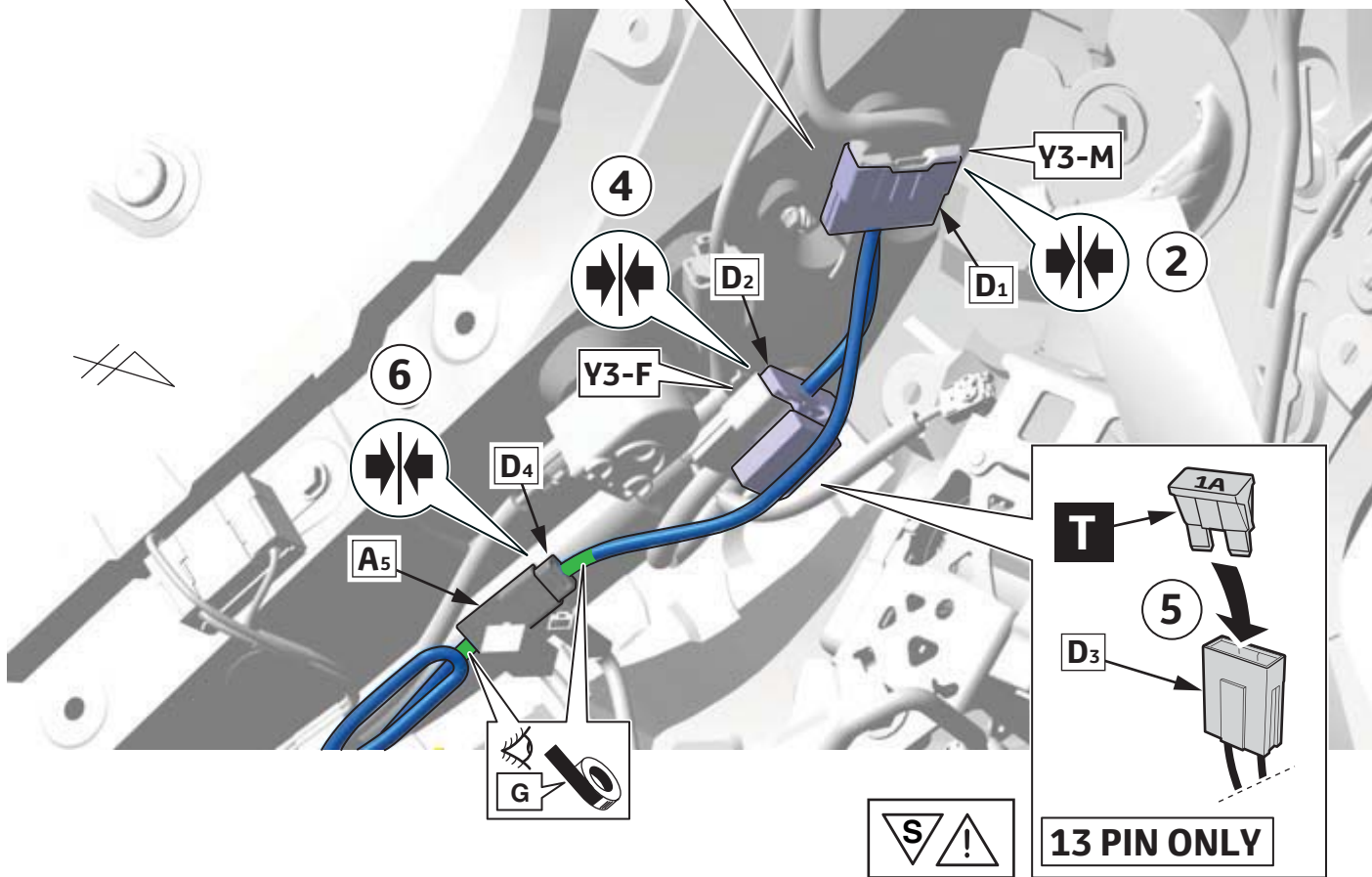
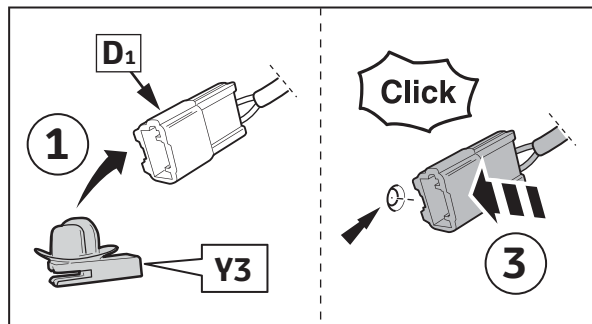
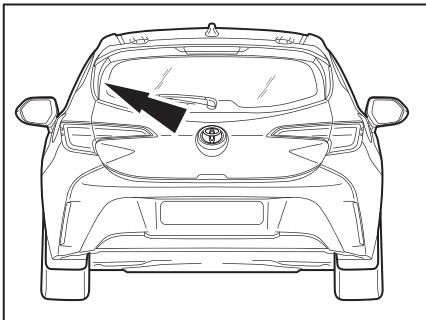



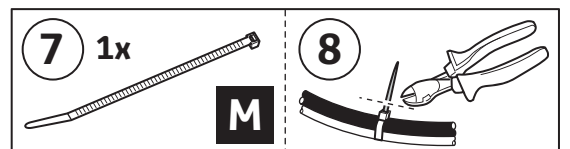
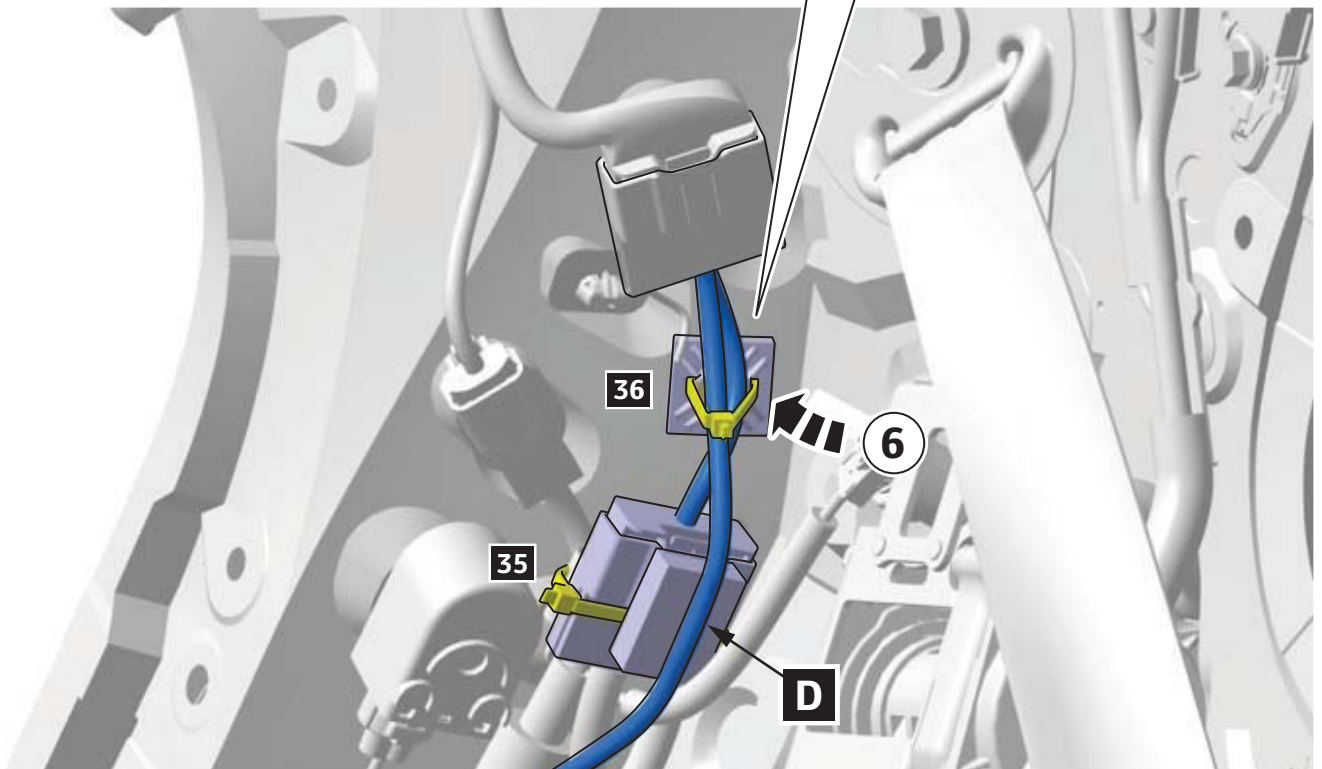
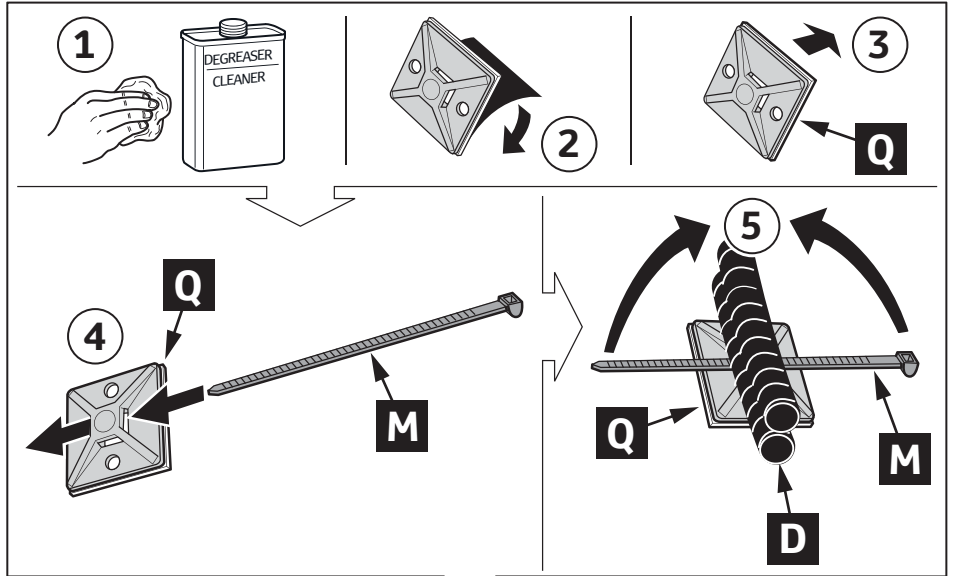
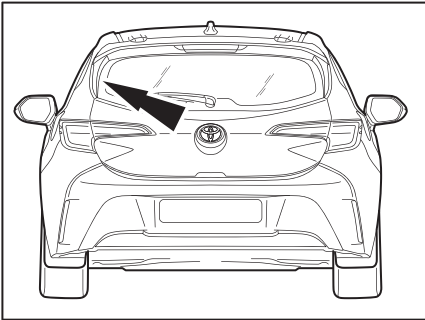

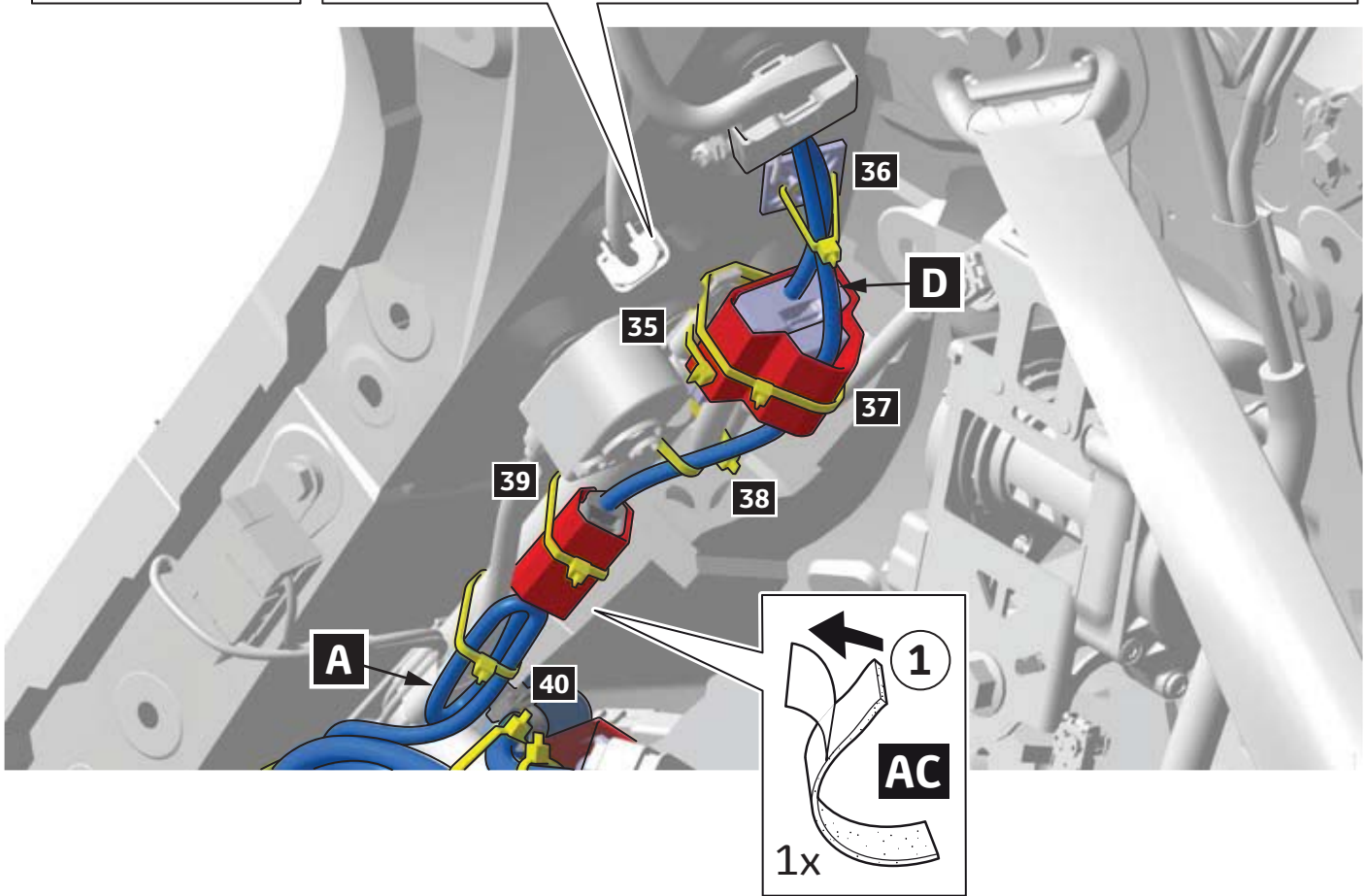
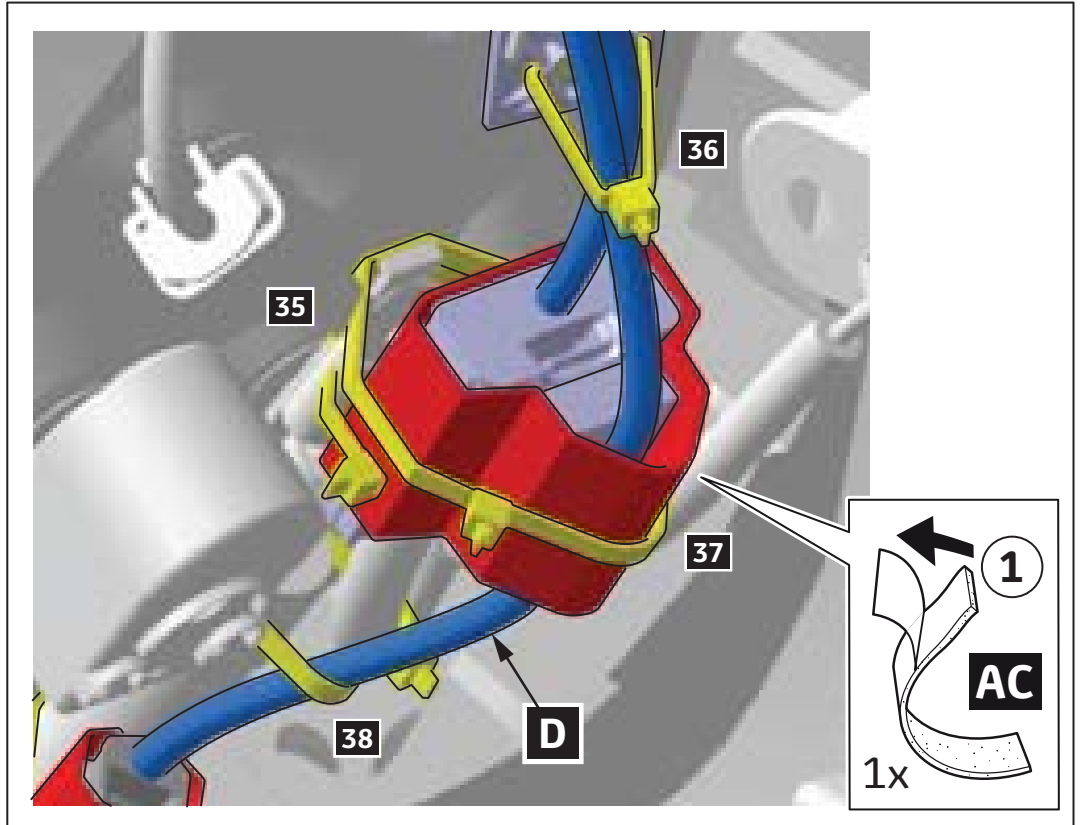

## VERTICAL DETACHABLE

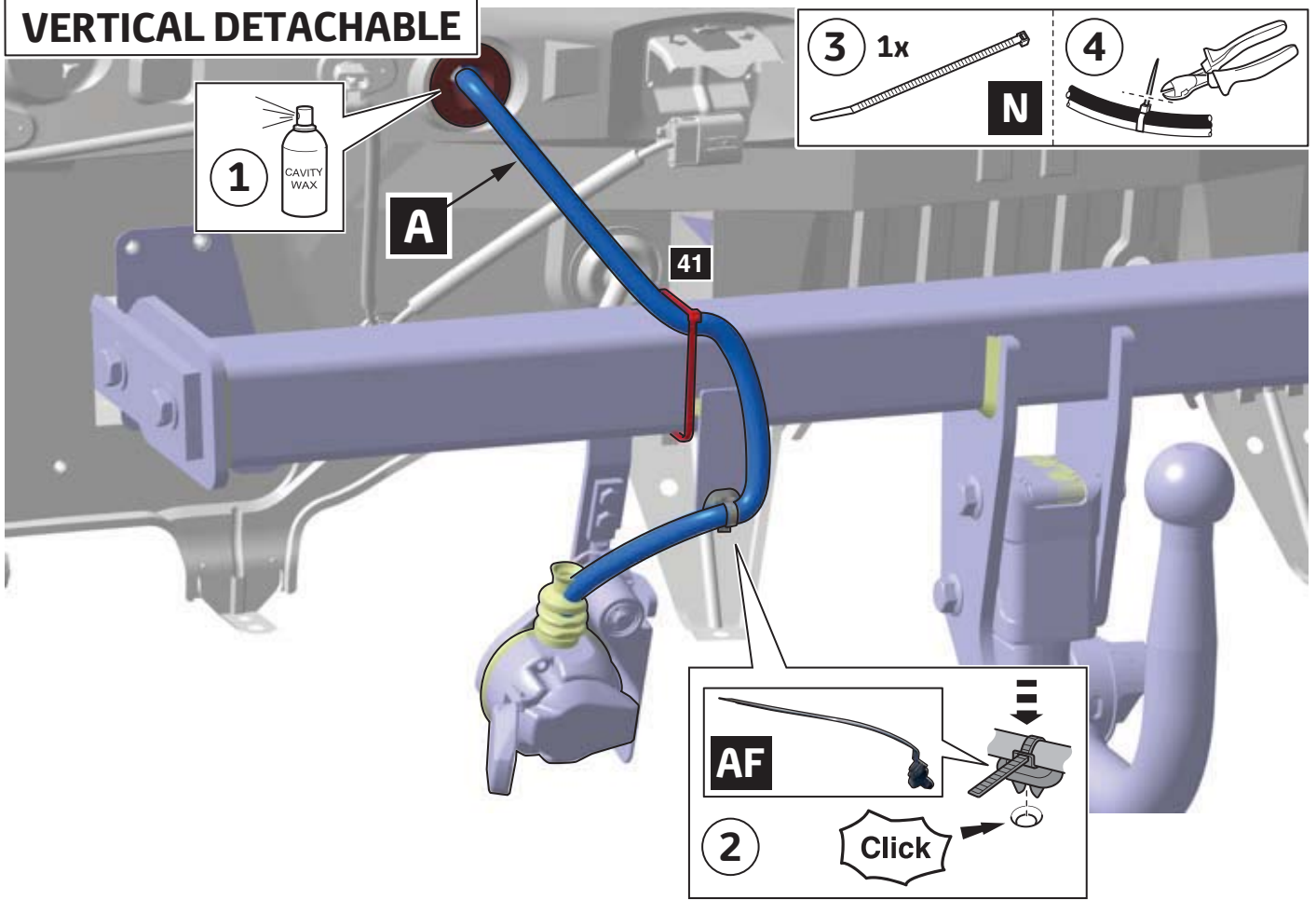

## HORIZONTAL DETACHABLE

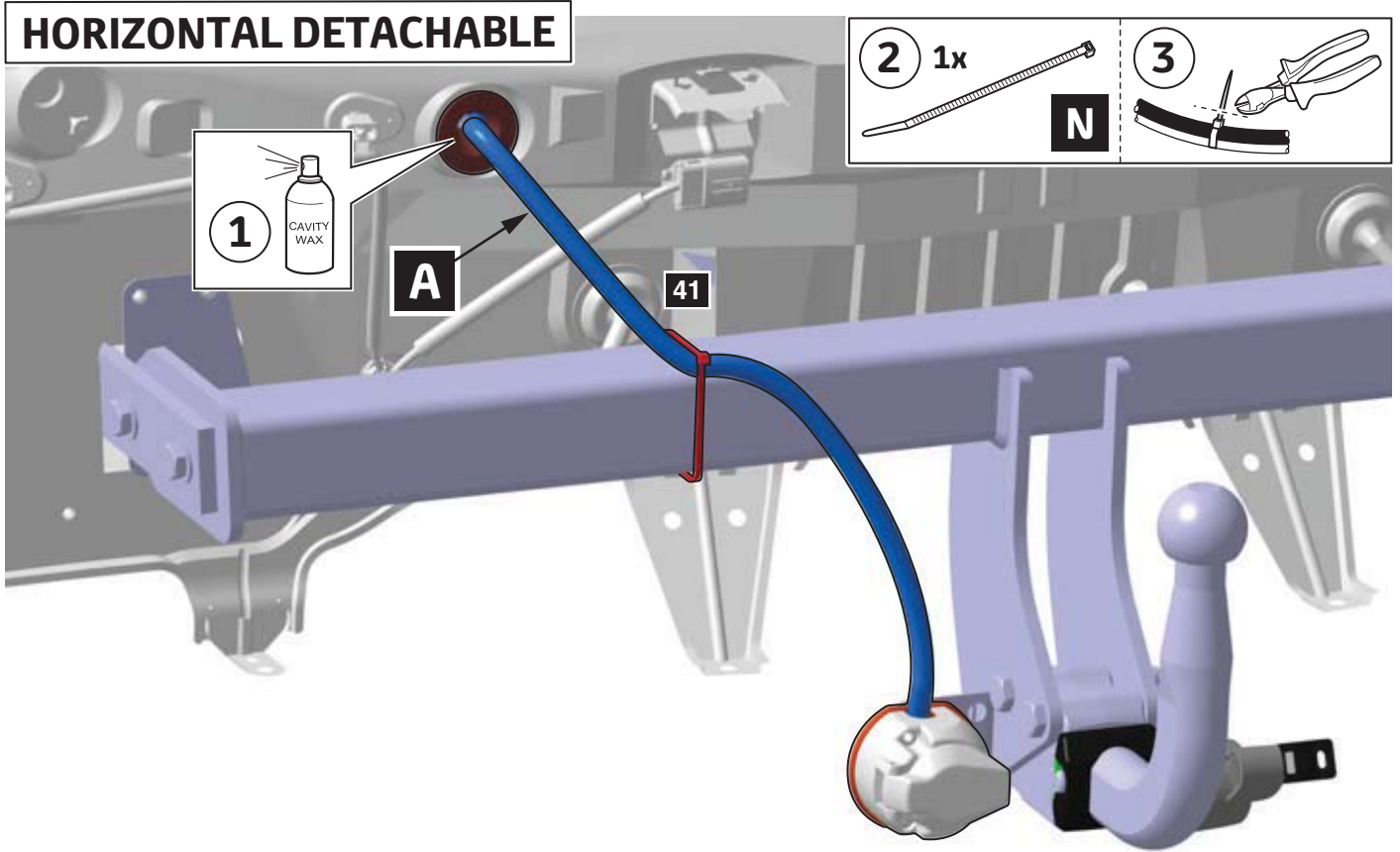

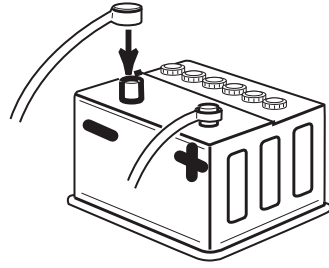
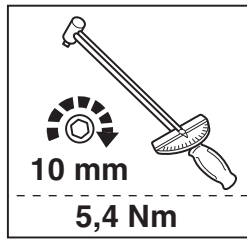

26

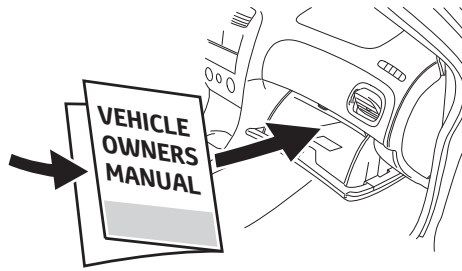
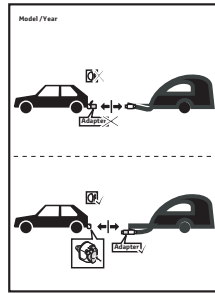

27







**TOYOTA**

Model/Year

Corolla (HB & 2.0L)  
2019/01

Towbar wiring kit 13-pin  
Towbar wiring kit 7-pin

VIN n°

ALWAYS A BETTER WAY

## DURING INSTALLATION

**1**

**P/N = OK**

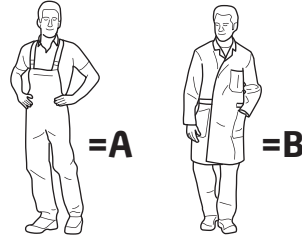

**2**

**7 PIN**

**S** **A**  **20A**

**B<sub>1</sub>**

**13 PIN**

FUSE	WH Color
20A	W-R
15A	W-BR
15A	Y-R

**R** **A**  **15A**

**S** **A**  **20A**

**T** **A**  **15A**

**D<sub>3</sub>** **A**  **1A**

**B**  **20A**

**3**

**Z** **Y** **W**

**Click**

Serial Number

9 Nm

**4**

**Click**

9 Nm  Serial Number

**5**

**U** (3x) **2 Nm** Serial Number

**Click**

**6**

**LHS=RHS**

**Click**

Serial Number

(6x) 6 Nm

**7**

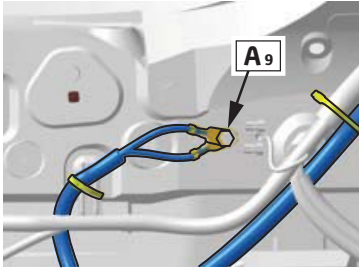

**A<sub>9</sub>**



**Click**

**9 Nm**

**Serial Number**

**8**

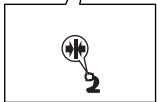
**2**

**AFTER INSTALLATION**

**1**





**Click**

**Serial Number**

**5,4 Nm**

**2**



**1**

**7 Pin**

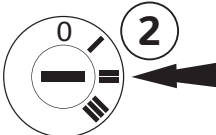
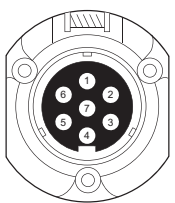

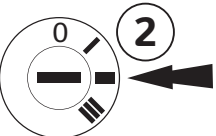
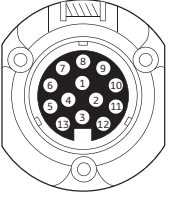

**13 Pin**



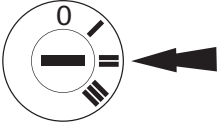
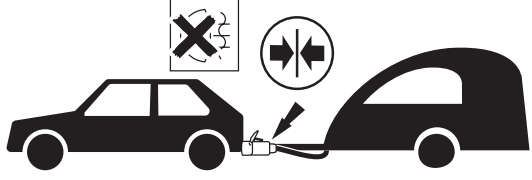
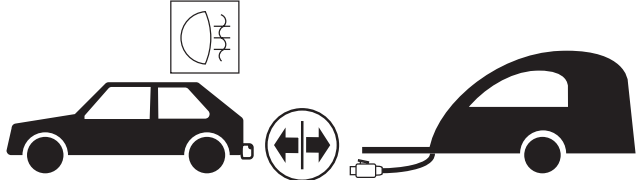

	<input type="checkbox"/>		<input type="checkbox"/>		<input type="checkbox"/>
	<input type="checkbox"/>		<input type="checkbox"/>		<input type="checkbox"/>
	<input type="checkbox"/>		<input type="checkbox"/>		<input type="checkbox"/>
	<input type="checkbox"/>		<input type="checkbox"/>		<input type="checkbox"/>
	<input type="checkbox"/>		<input type="checkbox"/>		<input type="checkbox"/>

**3**

**4**

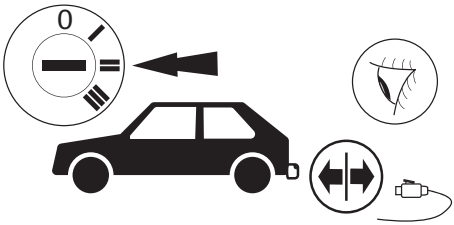

	<input type="checkbox"/>		<input type="checkbox"/>		<input type="checkbox"/>
	<input type="checkbox"/>		<input type="checkbox"/>		<input type="checkbox"/>

**5**

Beep

**6**

**7**

ENGINE START STOP

6 Sec.

ON OFF

A

B

**8**

ON OFF



**9**

1

2

ENGINE START STOP

PUSH

**10**

ABD 12

**11**

VEHICLE OWNERS MANUAL

**9**

FAILURE TEST FUNCTION

TESTER

3

Beeeeeeep

**12**

= OK

= OK

**13**

DIAGNOSTIC TOOL

NO DTC=OK

**14**

= OK

**15**

= OK

**Installation Date:**

... / ... / ...

**Technician Name & Signature:**

**Stamp:**

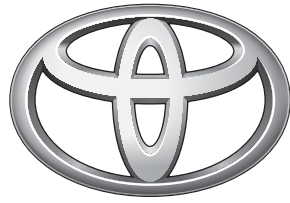

**TOYOTA**

Model /Year

Corolla (HB & 2.0L )  
2019/01

Towbar wiring kit 13-pin  
Towbar wiring kit 7-pin

