



TOYOTA

ALWAYS A
BETTER WAY

Auris (LHD)

Touch 2 with Go (Plus)

Installation Instructions

Model year: 2015/05

Vehicle code: **E18*L-D****W

Part number:	PZ490-00334-*0	Toyota Touch 2 with Go West-Europe
	PZ490-00335-*0	Toyota Touch 2 with Go East-Europe
	PZ490-00336-*0	Toyota Touch 2 with Go Plus West-Europe
	PZ490-00337-*0	Toyota Touch 2 with Go Plus East-Europe
	PZ490-00338-00	GPS Antenna Kit

Manual reference number: AIM 003 401-0

EN

- Expert Fitment Required.
- Disconnect the battery earth cable.
- To avoid damage to the wiring harness, ensure contact with sharp edges is prevented.
- Install parts as shown on illustrations.
- Re-connect battery.
- Re-fit panels, ensure that the wiring harness and other components are neatly and securely located.

DE

- Montage durch Fachwerkstatt erforderlich.
- Massekabel von Batterie abklemmen.
- Zur Vermeidung von Beschädigungen an der Isolierung ist Berührung mit scharfen Kanten zu vermeiden.
- Teile gemäß Abbildung montieren.
- Batterie wieder anschließen.
- Paneele wieder anbringen; achten Sie darauf, dass der Kabelbaum und andere Teile ordnungsgemäß und genau positioniert sind.

ES

- Montaje sólo por el concesionario.
- Desconectar el cable de masa de la batería.
- A efectos de evitar desperfectos en el aislamiento del cable, hay que evitar el contacto con aristas cortantes.
- Montar las piezas tal como se indica en las figuras.
- Vuelva a conectar la batería.
- Volver a colocar los paneles; preste atención a que el mazo del cable y las demás piezas tengan la posición correcta y precisa.

FR

- Montage par spécialiste nécessaire.
- Débrancher le câble de masse de la batterie.
- Eviter tout contact avec des arêtes vives afin de ne pas endommager l'isolation des câbles.
- Monter les pièces selon les figures.
- Reconnecter la batterie.
- Remette le panneau; veillez à ce que le faisceau et les autres pièces soient positionnés correctement et avec la précision requise.

IT

- E' necessario in officina specializzata.
- Staccare il cavo di massa dalla batteria
- Allo scopo di evitare danni all'isolazione dei cavi, evitare di metterli a contatto con spigoli acuti.
- Montare le parti secondo quanto rilevabile delle illustrazioni.
- Riconnettere la batteria.
- Rimettere in posizione i pannelli; far ben attenzione che il fascio di cavi e le altre parti siano state posizionate con esattezza e nella dovuta maniera.

PT

- Especialista em montagem requerido.
- Separe o cabo de terra do acumulador.
- Para não se danificar a isolação dos cabos, é conveniente evitar-se contacto com arestas afiadas.
- Monte as partes conforme ilustrado.
- Recolocar a bateria
- Tornar a colocar os painéis; verificar se a árvore de cabos e outras peças estão na posição exacta e prescrita.

NL

- Montage door vakman nodig.
- Massakabel van accu losmaken.
- Ter vermindering van beschadiging aan de isolatie van de elektrokit dient contact met scherpe kanten te worden vermeden.
- Delen overeenkomstig afbeelding monteren.
- Accu weer aansluiten.
- Panelen weer monteren; let erop, dat de kabelboom en andere delen correct en netjes gepositioneerd worden.

DA

- Montage ved professionelt værksted påkrævet.
- Stelkabel fjernes fra batteri.
- Berøring med skarpe kanter skal undgås for at undgå beskadigelse af kabelisoleringen.
- Dele skal monteres i henhold til illustrationer.
- Tilslut batteri igen.
- Paneler fastgøres igen; vær opmærksom på, at kabelsamlingen og andre dele placeres korrekt og præcist.

NO

- Nødvendig med montering fra fagverksted.
- Klem jordkabelen av batteriet.
- For å unngå skader på kabelisoleringen må berøring av skarpe kanter unngås.
- Monter alle deler i henhold til illustrasjonene.
- Tilkopli batteriet igjen.
- Monter panelene igjen, og pass på at kabelbunten og andre deler er anbrakt ordentlig og på riktig sted.

SV

- Verkstadsmontage erfordras.
- Lossa stomkabeln från batteriet.
- För att förhindra skador på ledningarnas isolation skall berøring med vassa kanter undvikas.
- Montera detaljerna enligt figurerna
- Anslut batteriet igen.
- Sätt tillbaka panelerna igen; kontrollera noga att ledningsmattan och andra detaljer ligger på rätt plats.

FI

- Asennus tarpeen merkikorkaamossa.
- Erotta maadoitusjohto akusta
- Pidä huoli myös siitä, että kaapelointi on korin kiinnityksen myötäinen ja kiinnitetty huolellisesti muihin liikkuviin osiin.
- Asenna osat kuvien mukaan.
- Kytke akku takaisin.
- Aseta paneelit paikalleen; tarkista, että kaapelointi ja muut osat ovat asianmukaisesti ja tarkalleen paikoillaan.

CS

- Montáž ve specializované dílně nutná.
- Odpojte zemnicí kabel od baterie.
- Zabraňte tomu, aby se kabely poškodily tím, že jsou položeny na ostrých hranách.
- Montujte části podle vyobrazení
- Opět připojte baterii.
- Opět připevněte panely; dbejte na to, aby svazek kabelů a ostatní části byly uloženy na správném místě.

HU

- A szereléshez szakműhely kell.
- Húzza le az akkumulátor testkábéljét.
- A kábelbiztosítás megsérülésének elkerülésére ügyeljen arra, hogy a kábel ne juthasson érintkezésbe éles peremű alkatrészekkel.
- Az alkatrészeket az ábrák szerint szerelje be.
- Ismét csatlakoztassa az akkumulátort.
- Szerelje vissza a fedőlapokat, ügyeljen arra, hogy a ábelek és a többi alkatrész pontosan a számukra kijelölt helyen maradjanak.

EL

- Να τοποθετεί από συνεργείο.
- Αποσυνδέστε το καλώδιο γείωσης από τη μπαταρία.
- Για να αποφευχθούν ζημιές στη μόνωση καλωδίων, να αποφεύγεται η επαφή των με αιχμηρές ακμές.
- Τοποθέτηση των μερών σύμφωνα με τις Εικόνες.
- Συνδέστε πάλι τη μπαταρία.
- Τοποθετήστε πάλι το κάλυμμα- προσοχή, η πλεξούδα καλωδίων και άλλα μέρη να είναι τοποθετημένα ακριβώς και σύμφωνα με τους κανονισμούς.

TR

- Uzmanın takması gereklidir.
- Akü toprak kablosunu ayırın.
- Kablo demetinin hasar görmemesi için, sivri objelerle temasın engellenmesini sağlayın.
- Parçaları çizimlerde gösterildiği gibi takın.
- Aküyü tekrar bağlayın.
- Panoları tekrar takın, kablo demeti ve diğer komponentlerin tam ve sıkıca yerleşmesini sağlayın.

ET

- Paigaldada spetsialisti poolt.
- Võtke massikaabel aku küljest lahti.
- Juhtmestiku kahjustamise vältimiseks hoidke juhtmed eemal teravatest servadest.
- Paigaldage osad vastavalt joonistele.
- Ühendage aku.
- Paigaldage kattepaneelid; veenduge, et juhtmestik ja muud osad on paigutatud korrektselt ning kindlalt.

LT

- Būtina, kad sumontuotų specialistas.
- Atjunkite akumuliatoriaus įžemimo laidą.
- Tam, kad išvengtumėte įvado apgadinimo, saugokite, kad laidai nesiliestų prie aštrių briaunų.
- Sumontuokite dalis taip, kaip pavaizduota iliustracijoje.
- Prijunkite akumuliatorių.
- Į vietas įdėkite skydelius, patikrinkite, ar laidų šarvai ir kiti komponentai yra savo vietose ir gerai pritvirtinti.

SL

- Potrebna je strokovna montaža.
- Odklopite ozemljitveni kabel akumulatorja.
- Da preprečite poškodbe kablskega snopa, preprečite stik z ostrimi robovi.
- Dele namestite, kot je prikazano na slikah.
- Ponovno priklonite akumulator.
- Ponovno montirajte panele in zagotovite, da so kablски snop in druge komponente nameščene varno.

PL

- Konieczny montaż przez warsztat specjalistyczny.
- Odłączyć przewód masy od akumulatora.
- Dla zapobieżenia uszkodzeniu izolacji chronić przed zetknięciem z ostrymi krawędziami.
- Zamontować części zgodnie z rysunkiem.
- Ponownie podłączyć akumulator.
- Na powrót osadzić osłony; zadbać aby wiązka kablowa i inne części były właściwie i dokładnie ułożone.

RU

- Монтаж должны выполнять специалисты в мастерской
- Отсоединить заземляющий кабель аккумулятора
- Во избежание повреждений изоляции кабеля не допускать соприкосновения с острыми углами
- Монтировать части согласно иллюстрации
- Снова подключить аккумулятор
- Установить панель, проверить правильность и точность расположения кабелей и других частей.

BG

- Изисква се поставяне от специалист.
- Откачете заземляващия кабел на акумулатора.
- За избягване на повреди по кабелния сноп се уверете, че няма контакт с остри ръбове.
- Монтирайте частите според показаното на илюстрацията.
- Свържете отново акумулатора.
- Поставете отново панелите, уверете се, че кабелният сноп и останалите компоненти са разположени подредено и надеждно.

LV

- Nepieciešami īpaši saliekamie elementi.
- Atvienojiet akumulatora zemējuma vadu.
- Lai nesabojātu elektroinstalāciju, nepieskarieties tai ar asiem priekšmetiem.
- Uzstādiet detaļas, kā parādīts attēlos.
- Pievienojiet akumulatoru.
- Uzlieciet paneļus, raugieties, lai elektroinstalācija un citas daļas būtu kārtīgi un stingri nofiksētas.

RO

- Este necesară instalarea de către un specialist.
- Deconectați cablul de împământare a bateriei.
- Pentru a evita deteriorarea cablajului, evitați contactul cu muchiile ascuțite.
- Montați componentele așa cum este prezentat în figuri.
- Reconectați bateria
- Reinstalați panourile, aveți grijă de plasarea îngrijită și în condiții de siguranță a cablajului și a celorlalte componente.

SK

- Vyžaduje sa profesionálne vybavenie.
- Odpojte zemniaci vodič akumulátora.
- Káblové zväzky sa nesmú dotýkať ostrých okrajov, aby sa nepoškodili.
- Dielce založte tak, ako je znázornené na obrázkoch.
- Znovu zapojte akumulátor.
- Založte panely a uistite sa, že káblové zväzky a iné dielce sú bezpečne a prehľadne uložené.

Revision record



Rev. No.	Date	Page	Picture	Update	New	Deleted steps

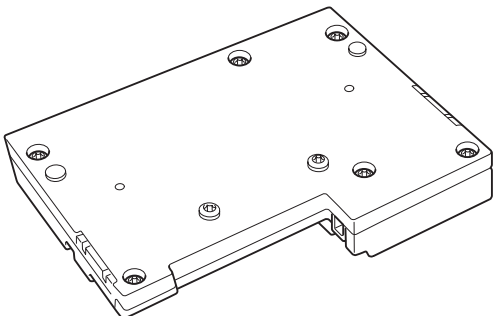
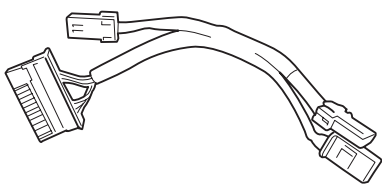
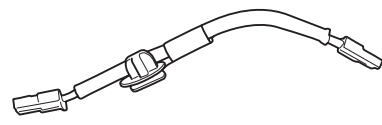
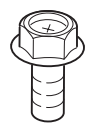

PZ490-00334-*0 WEST-EU LOW
PZ490-00335-*0 EAST-EU LOW
PZ490-00336-*0 WEST-EU HIGH
PZ490-00337-*0 EAST-EU HIGH

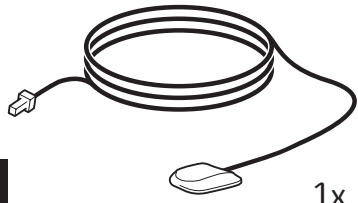
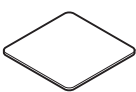
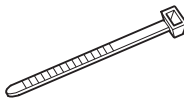
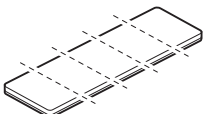
 <p>A 86840-***** WEST-EU LOW 86840-***** EAST-EU LOW 86840-***** WEST-EU HIGH 86840-***** EAST-EU HIGH 1x</p>	 <p>B 86842-12010 1x</p>  <p>C 86705-02070 1x</p>	 <p>D 90153-W0001 6x</p>
---	--	---

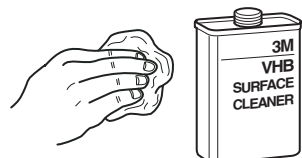
PZ490-00338-00

 <p>E 1x</p>	 <p>1x</p>	 <p>5x</p>	 <p>FOAM PAD 1x</p>
--	---	--	---

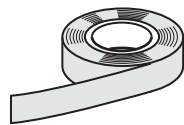
		
---	---	---

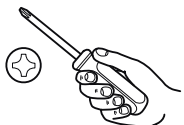
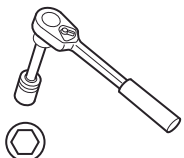
			
---	---	--	---



40°C

18°C



1

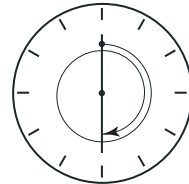
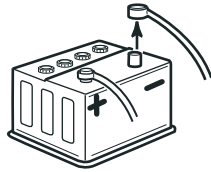
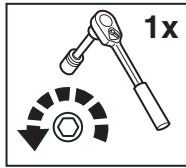

90 sec

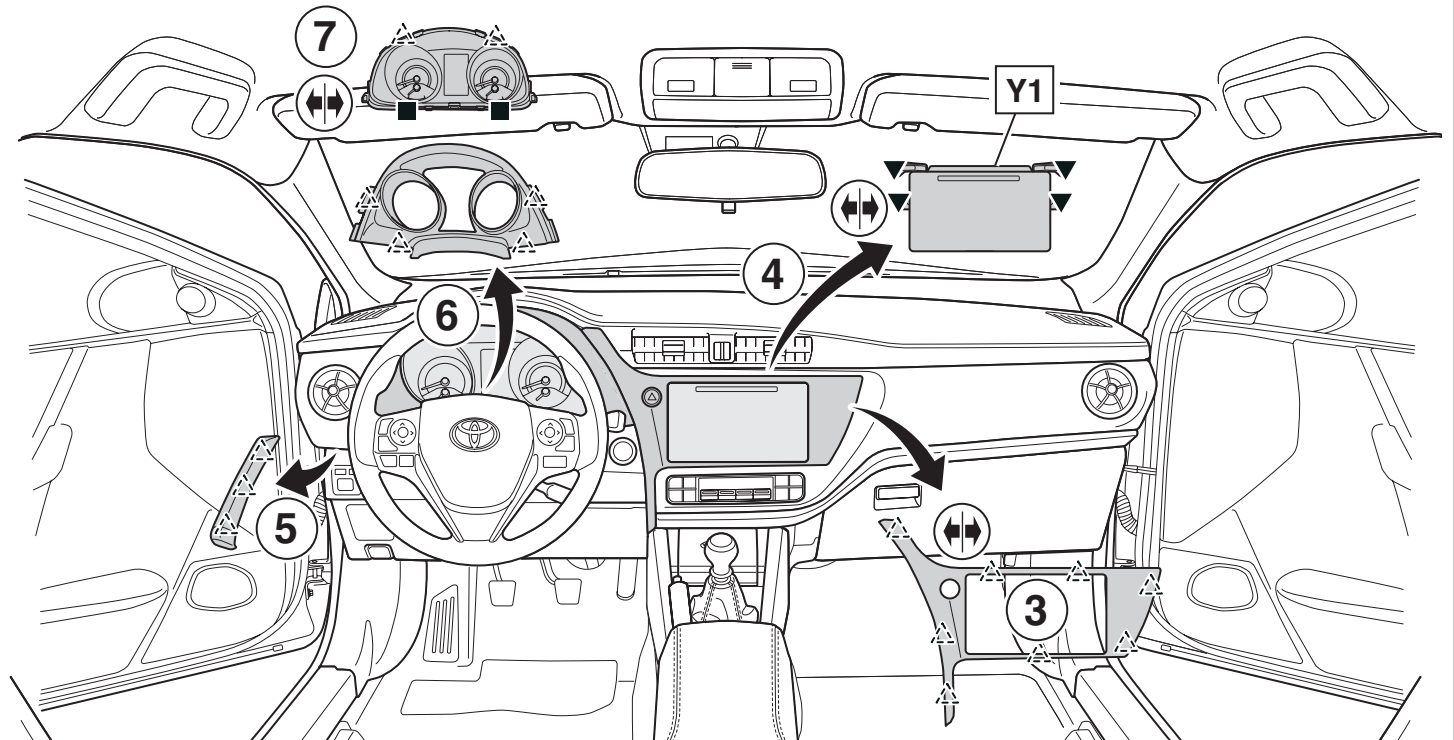
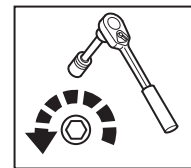
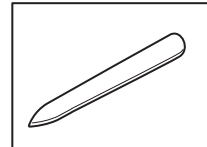
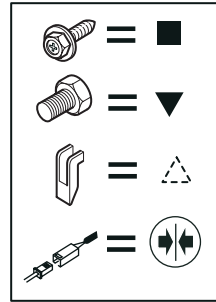
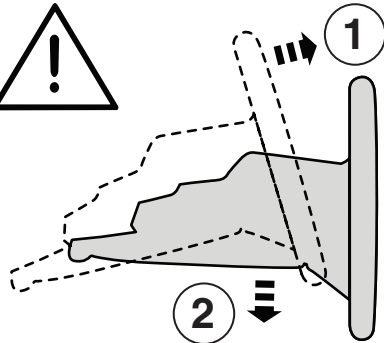

2

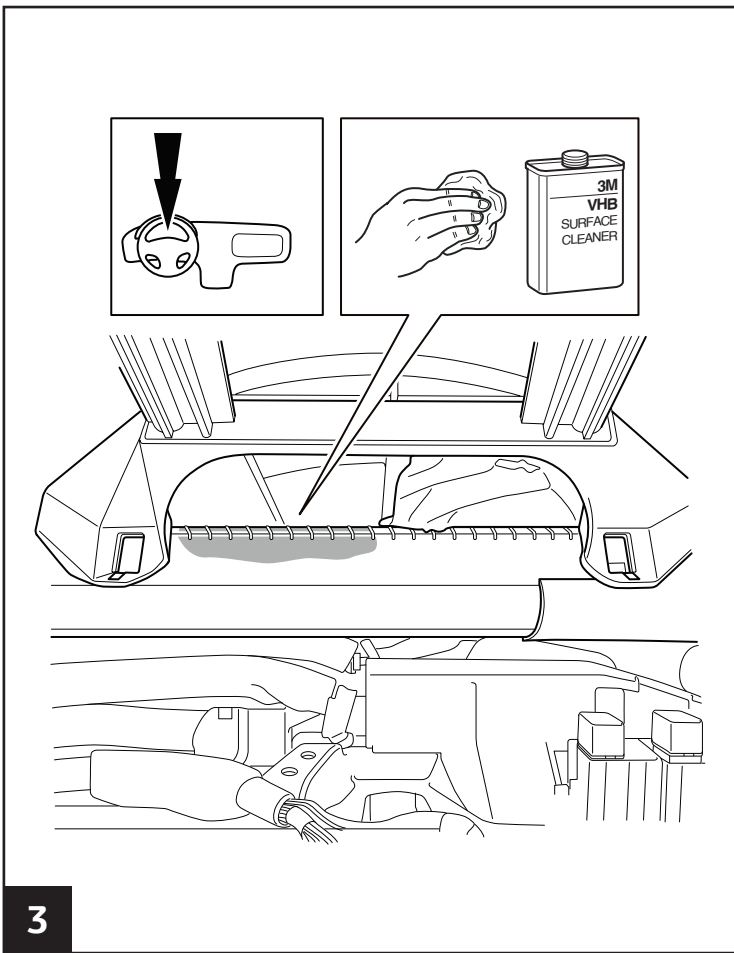

3

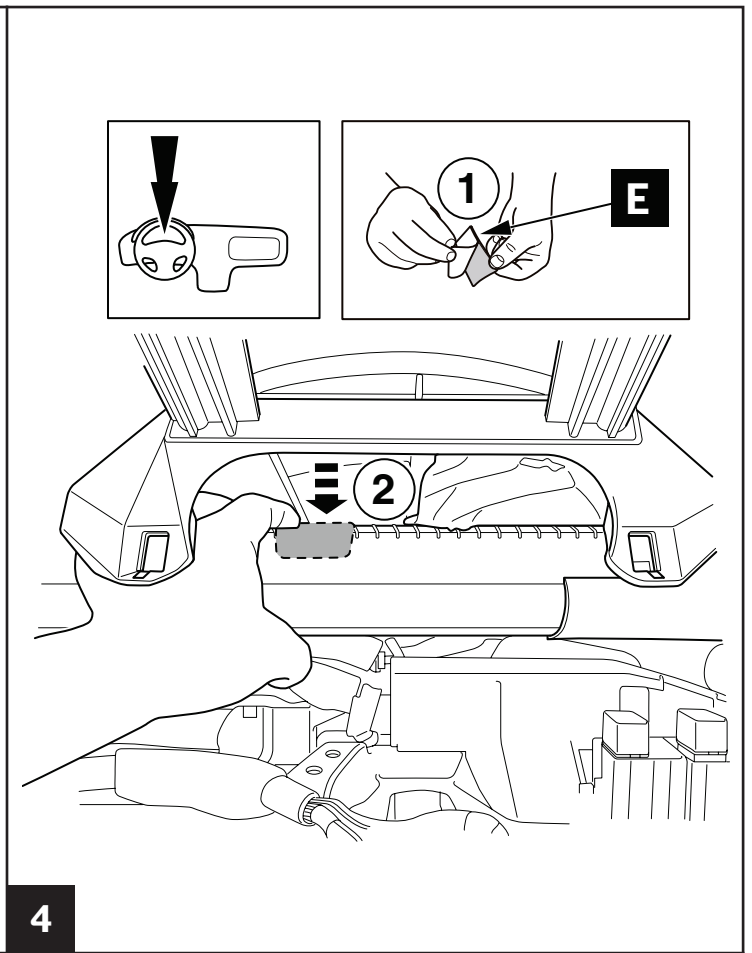

4

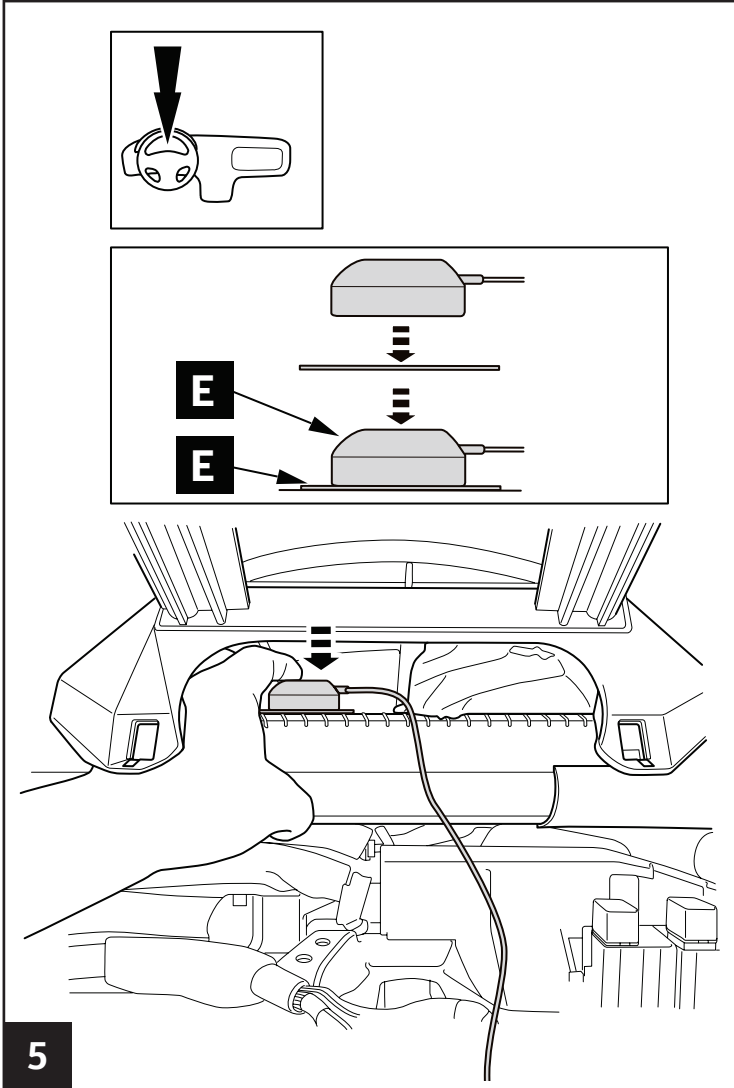

5

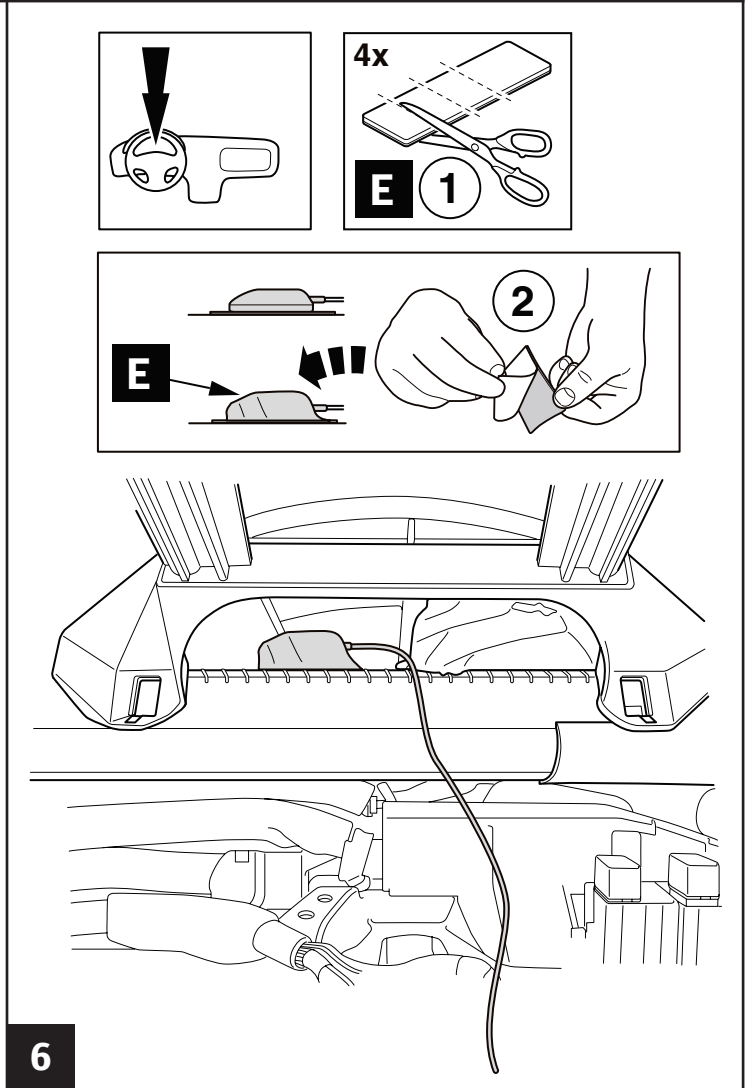

6

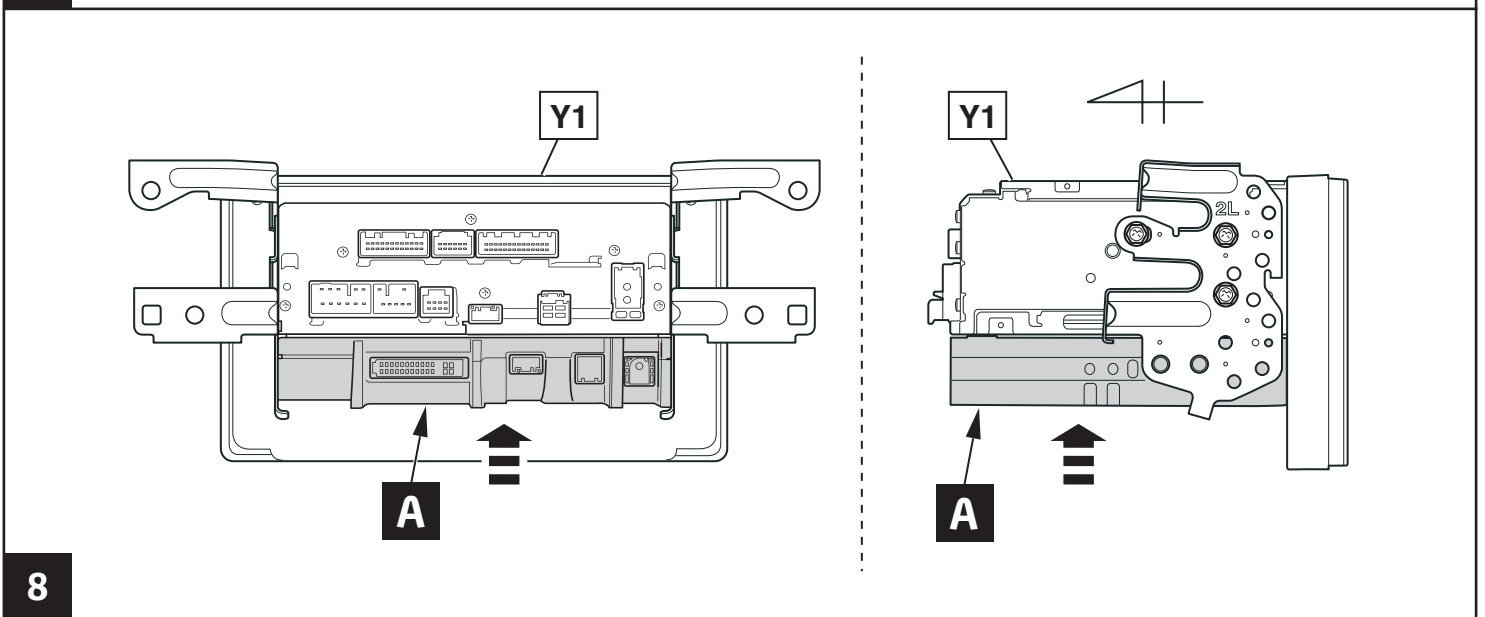
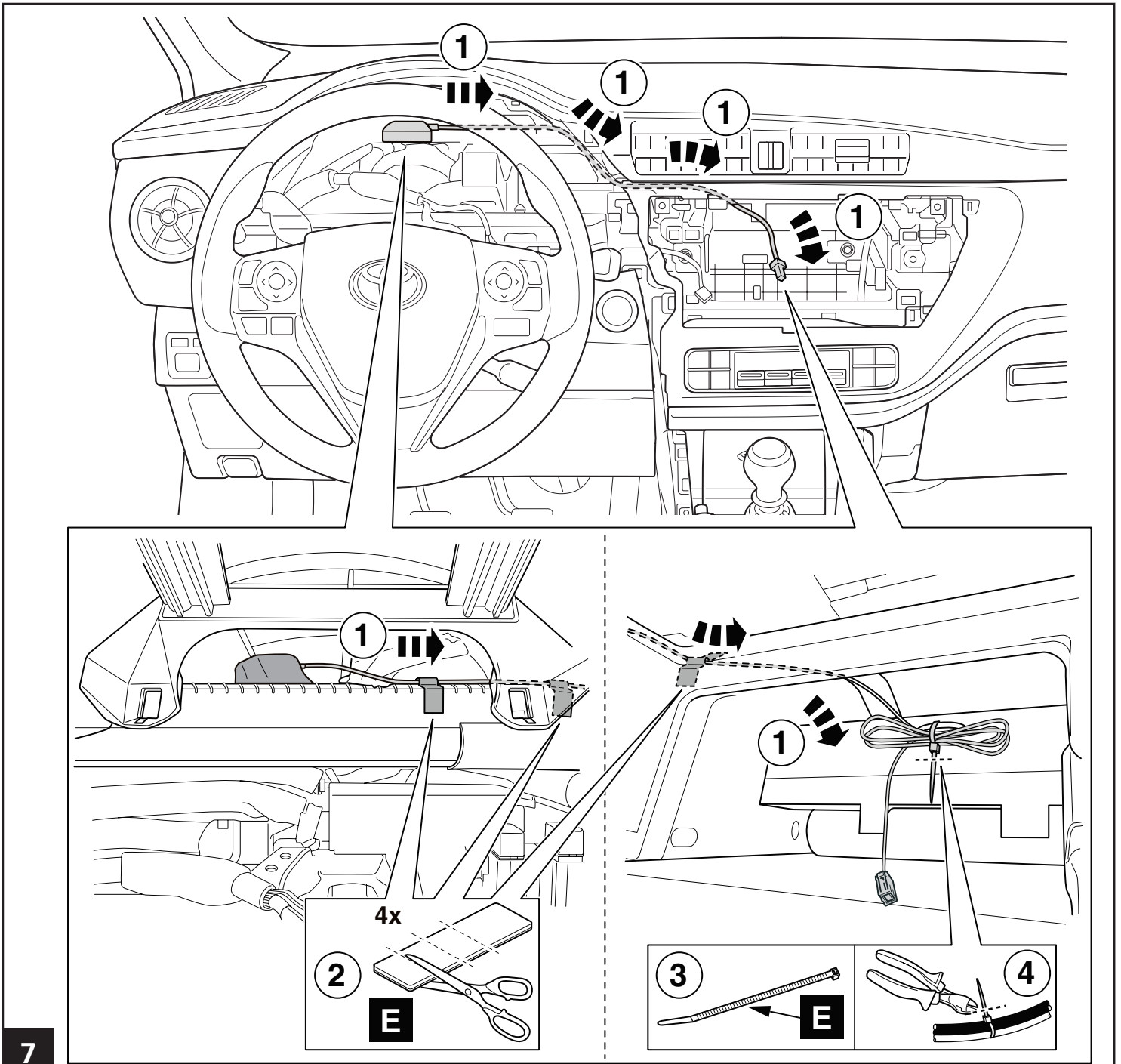

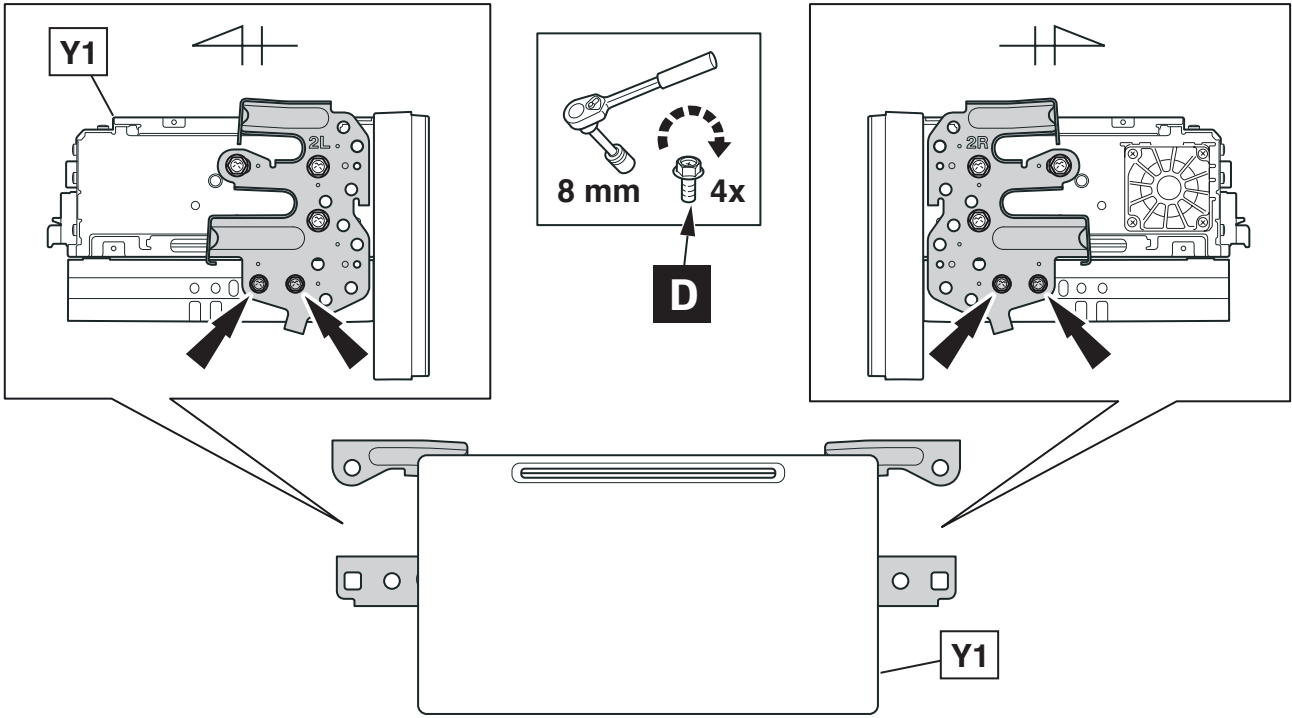

9

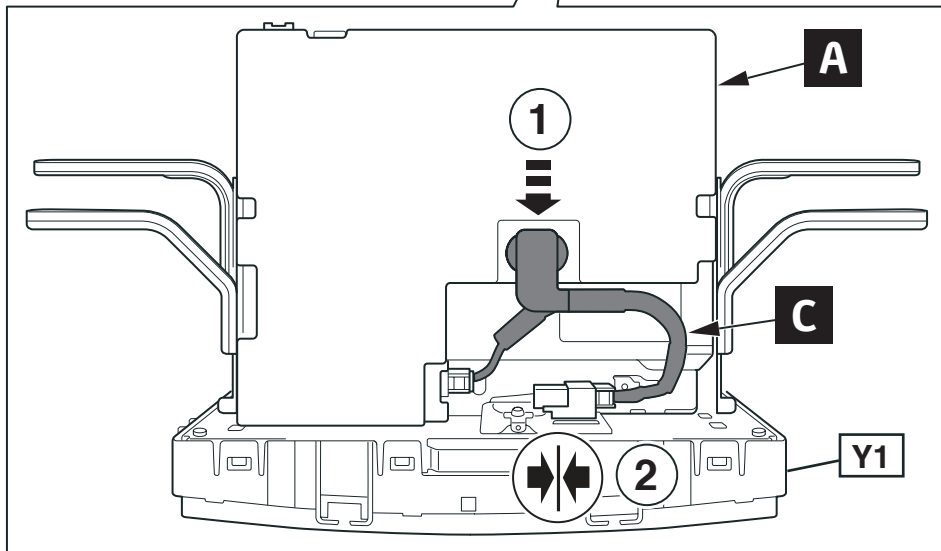
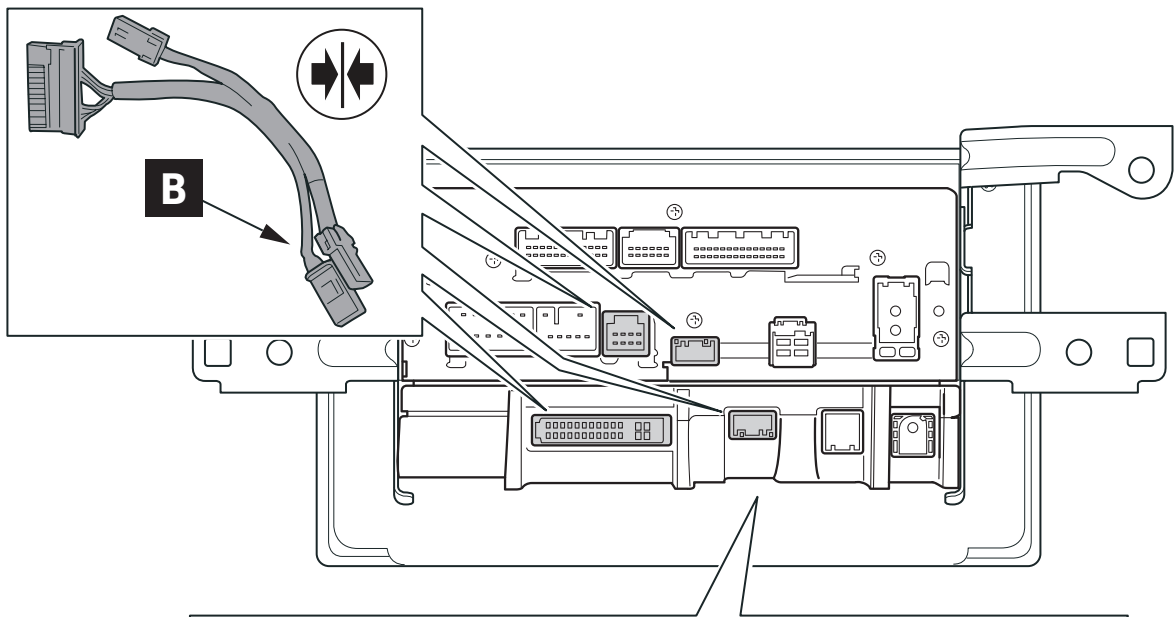

10

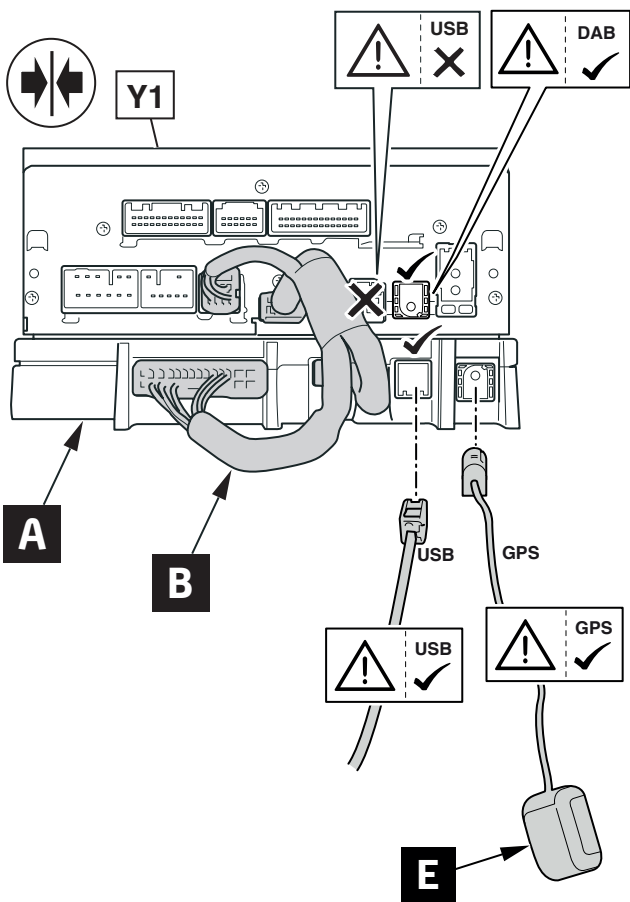

DAB

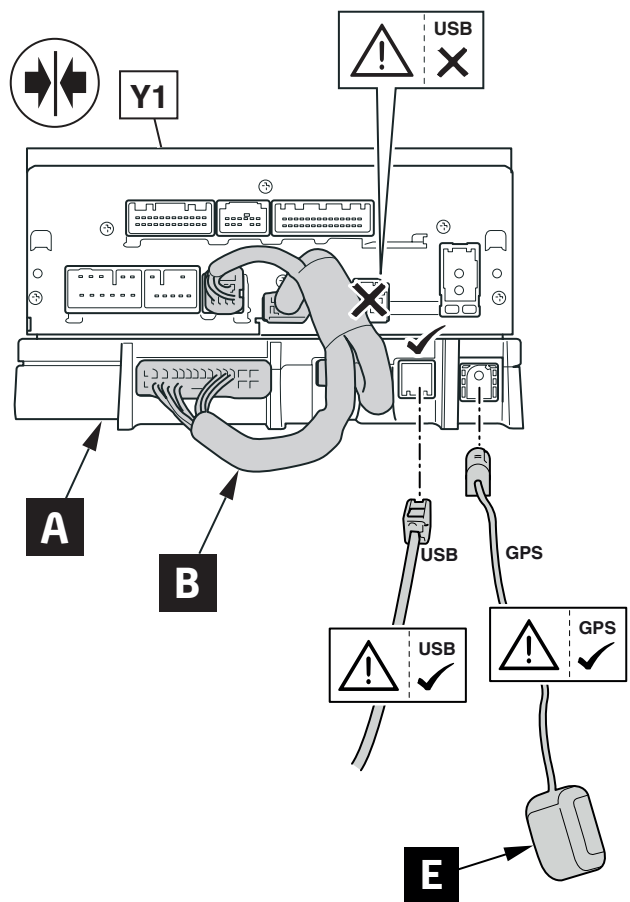

NO DAB

11

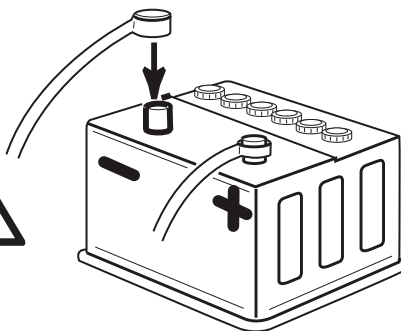
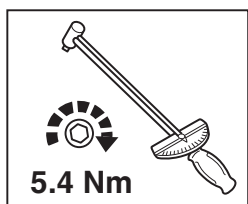

12

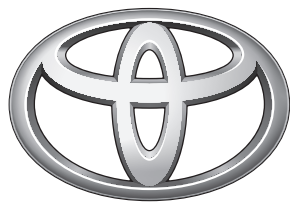

TOYOTA

CHECK SHEET



TOYOTA

Model / Year Auris (LHD) 2015/05 Touch 2 with Go (Plus)

VIN n°

ALWAYS A BETTER WAY

P/N = OK

5,4 Nm

CLICK

Serial Number

DAB FM-AM

TechDoc 1 > Repair > Touch & Go Diagnostic Information

Function Check Setting > Vehicle Signal

PKB ON / OFF

USB

AUX

GPS

1 2 3

R

= OK

Installation Date:
 . . / . . /

Technician Name & Signature:

Stamp: