

Taxi Divider

Installation Instructions



Model/Model year:	Corolla (HB)	As from 2019/01
	Corolla (TS)	As from 2019/02
	Corolla (Sedan)	As from 2019/01
	Auris	As from 2015/05 - Until 2018/12
	Toyota C-HR	As from 2016/10
	Prius	As from 2015/12
	Prius Plug-in	As from 2016/09
	Camry	As from 2017/09
	UX	As from 2018/10
	UX/UX300e	As from 2020/08











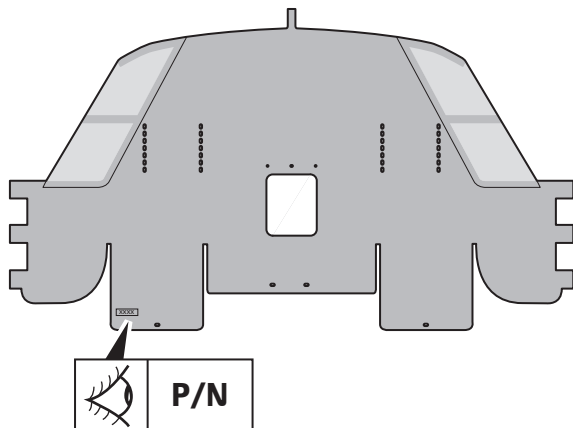

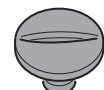
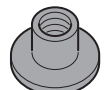

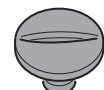
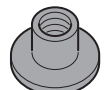

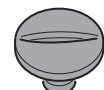
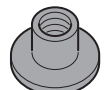
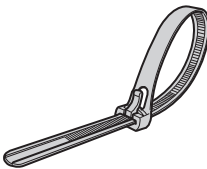
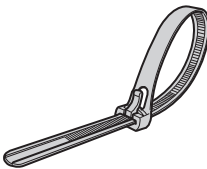

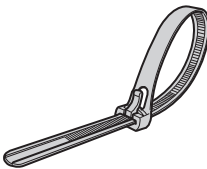

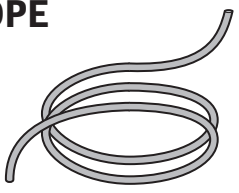

Part number: PW710-02000

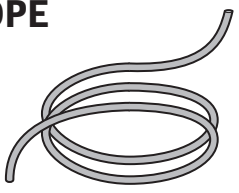
Manual reference number: AIM 006 007-1

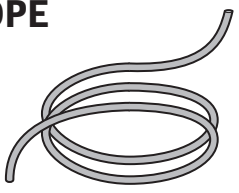
Revision record

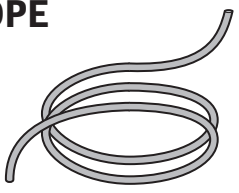
Rev. No.	Date	Page	Step	Remarks
△ 1	14.07.2020	9	14	Tie band updated.

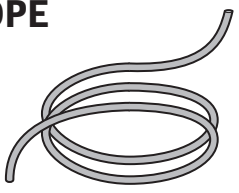
PW710-02000

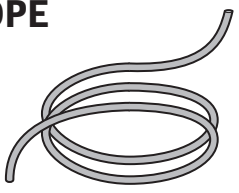
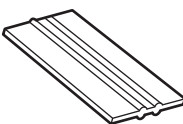
	<table border="1" style="width: 100%; border-collapse: collapse;"> <tr> <td style="text-align: center;">B</td> <td style="text-align: center;"></td> <td style="text-align: right;">x1</td> </tr> <tr> <td style="text-align: center;">C</td> <td style="text-align: center;"></td> <td style="text-align: right;">x1</td> </tr> <tr> <td style="text-align: center;">D</td> <td style="text-align: center;"></td> <td style="text-align: right;">x3</td> </tr> <tr> <td style="text-align: center;">E</td> <td style="text-align: center;"></td> <td style="text-align: right;">x3</td> </tr> </table>	B		x1	C		x1	D		x3	E		x3
B		x1											
C		x1											
D		x3											
E		x3											
<table border="1" style="width: 100%; border-collapse: collapse;"> <tr> <td style="text-align: center;">F</td> <td style="text-align: center;"></td> <td style="text-align: right;">x2</td> </tr> </table>	F		x2	<table border="1" style="width: 100%; border-collapse: collapse;"> <tr> <td style="text-align: center;">G</td> <td style="text-align: center;"> Elastic 290mm  </td> <td style="text-align: right;">x2</td> </tr> </table>	G	Elastic 290mm 	x2						
F		x2											
G	Elastic 290mm 	x2											
<p>NOT INCLUDED - OPTIONAL</p> <table border="1" style="width: 100%; border-collapse: collapse;"> <tr> <td style="text-align: center;"></td> <td style="text-align: center;"> <table border="1" style="width: 100%; border-collapse: collapse;"> <tr> <td style="text-align: center;"></td> <td style="text-align: center;">ROPE</td> </tr> <tr> <td style="text-align: center;">H</td> <td style="text-align: center;">  </td> <td style="text-align: right;">x1</td> </tr> </table> </td> </tr> </table>			<table border="1" style="width: 100%; border-collapse: collapse;"> <tr> <td style="text-align: center;"></td> <td style="text-align: center;">ROPE</td> </tr> <tr> <td style="text-align: center;">H</td> <td style="text-align: center;">  </td> <td style="text-align: right;">x1</td> </tr> </table>		ROPE	H		x1					
	<table border="1" style="width: 100%; border-collapse: collapse;"> <tr> <td style="text-align: center;"></td> <td style="text-align: center;">ROPE</td> </tr> <tr> <td style="text-align: center;">H</td> <td style="text-align: center;">  </td> <td style="text-align: right;">x1</td> </tr> </table>		ROPE	H		x1							
	ROPE												
H		x1											
													

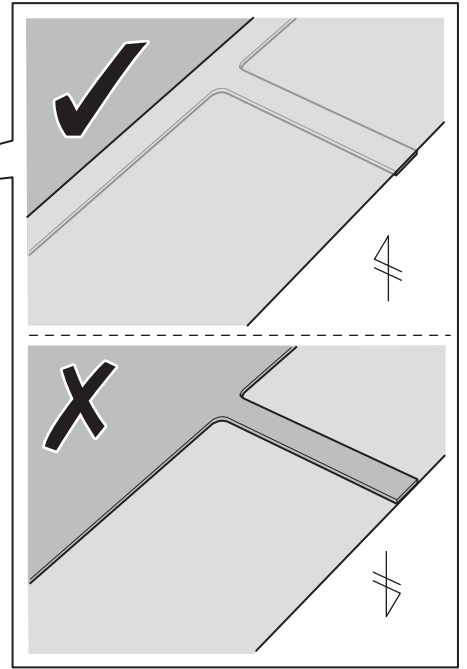
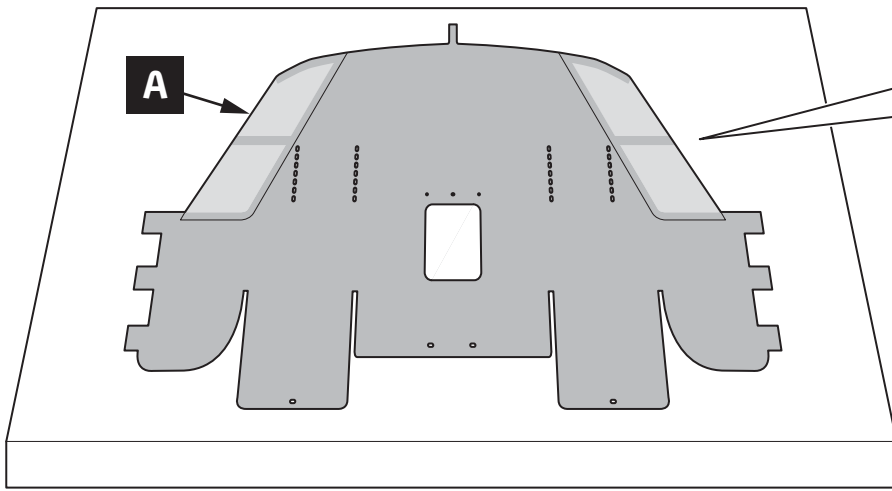

1

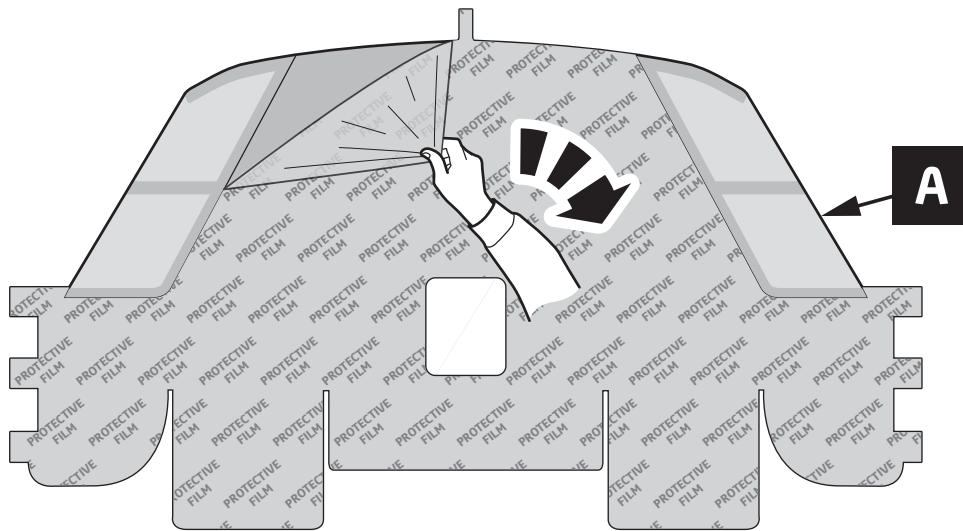

2

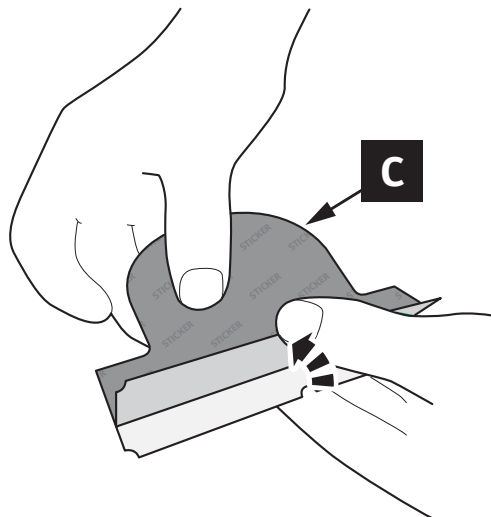

3

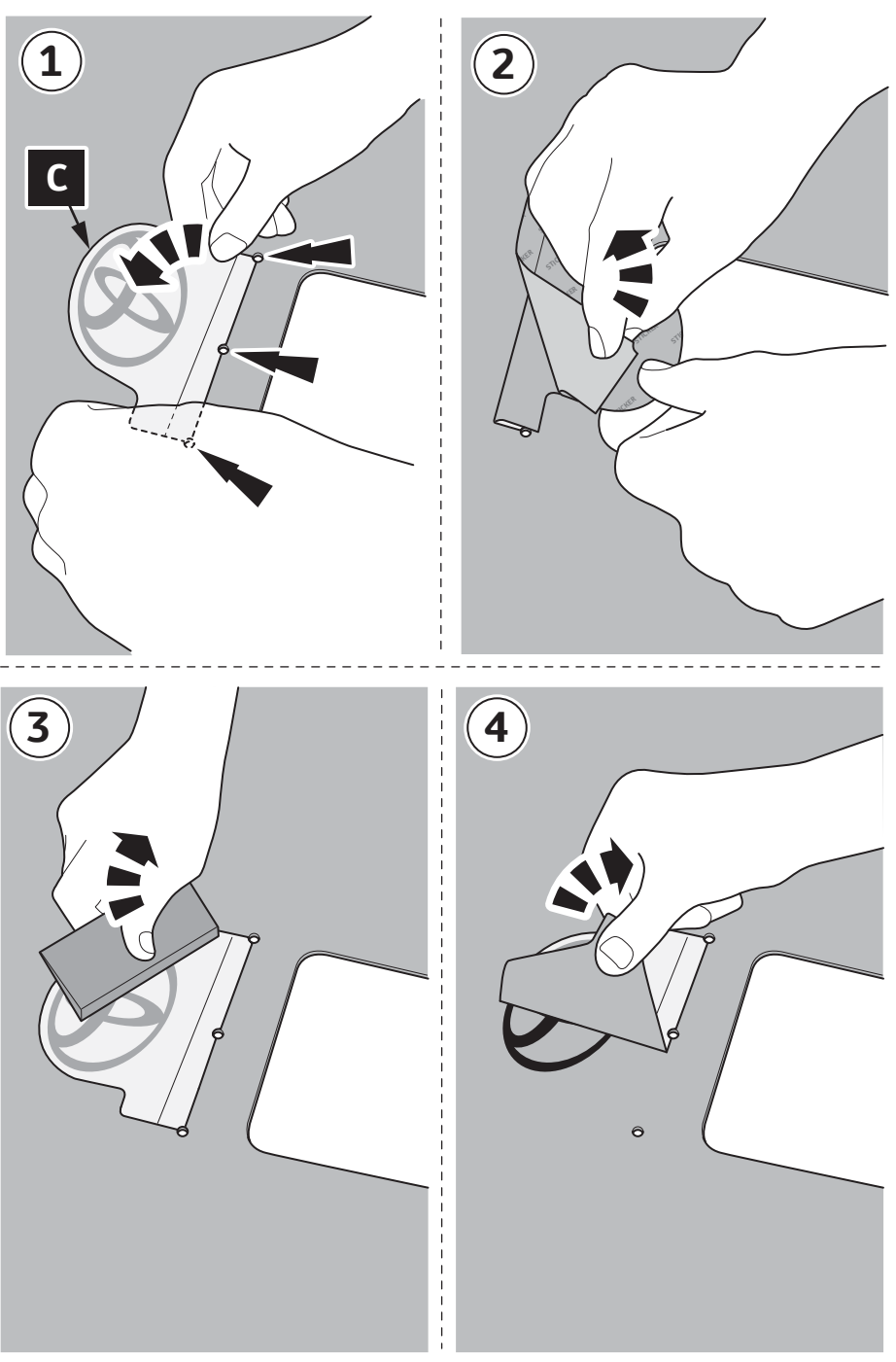
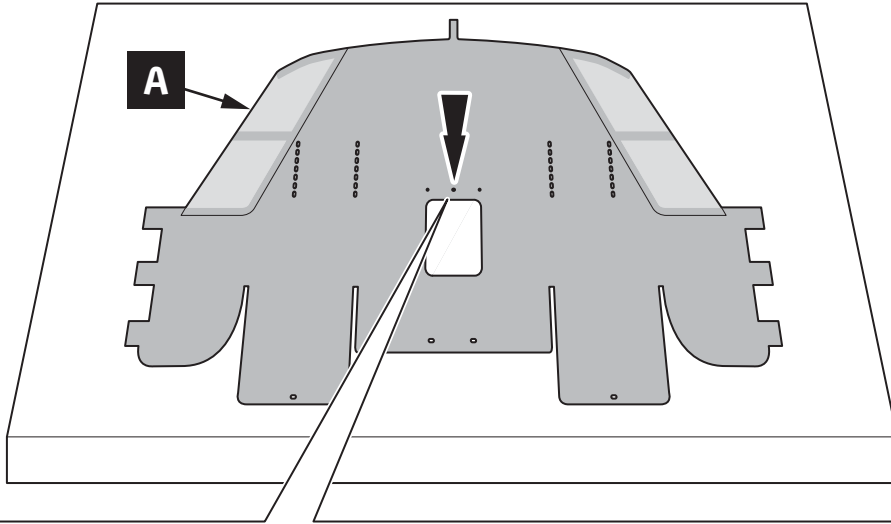

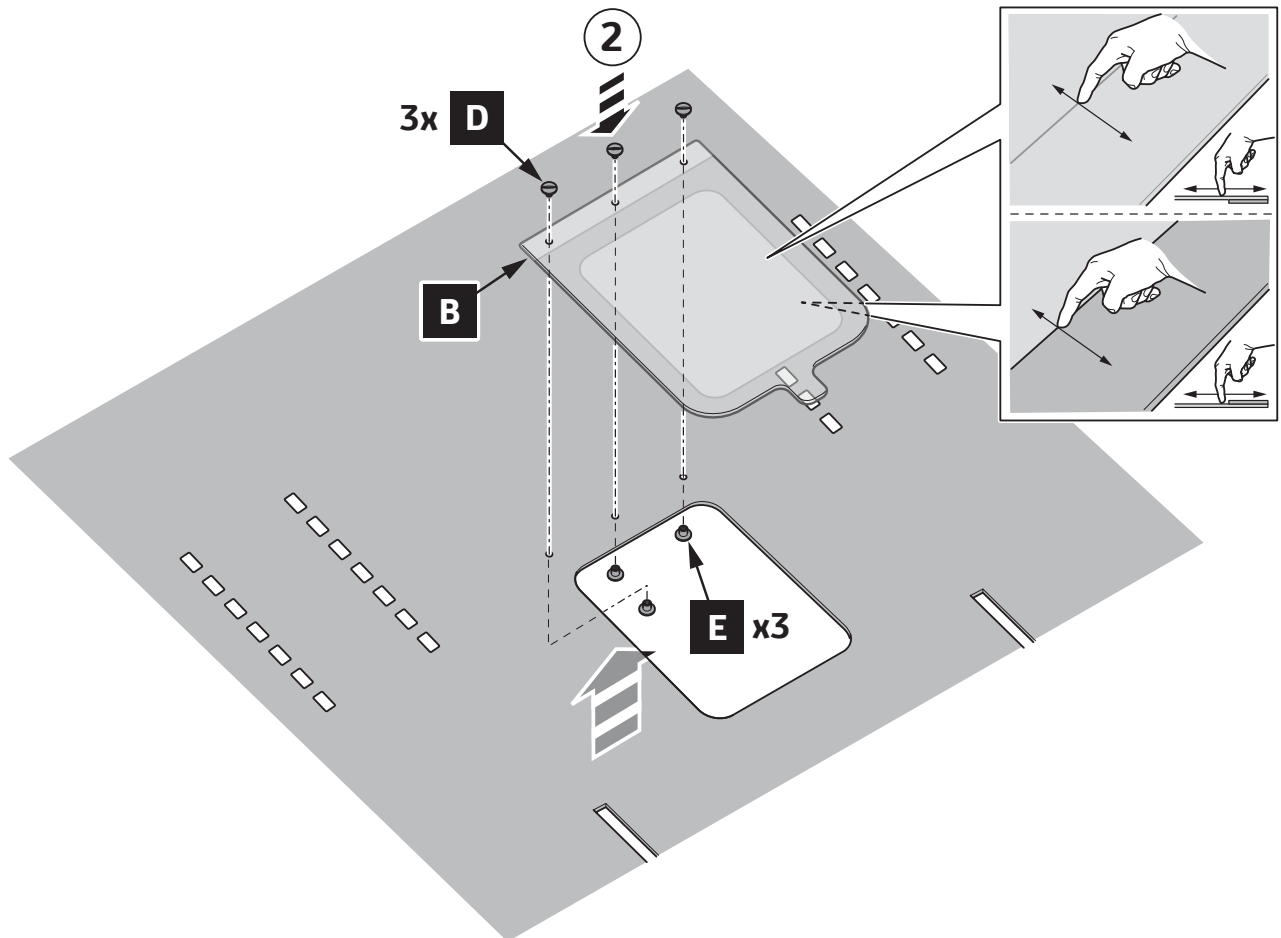
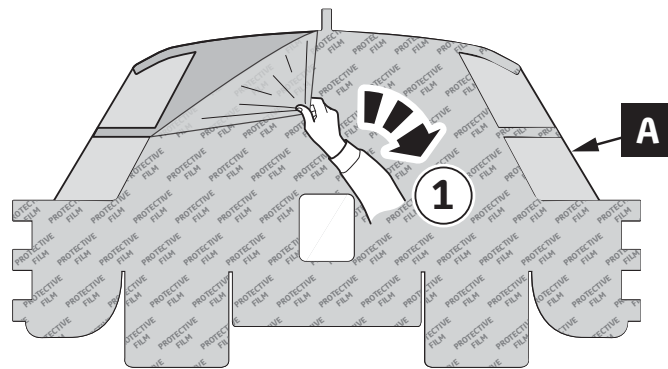
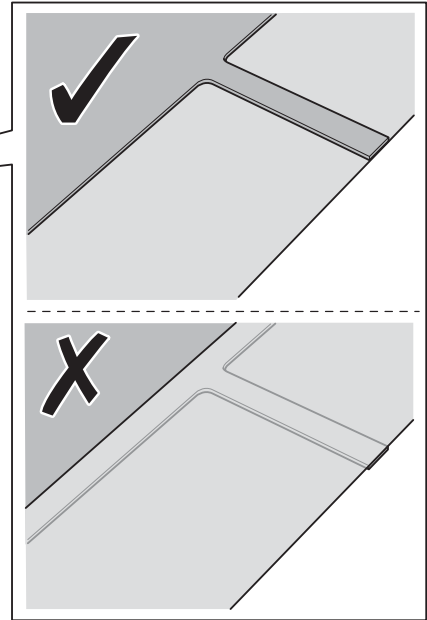
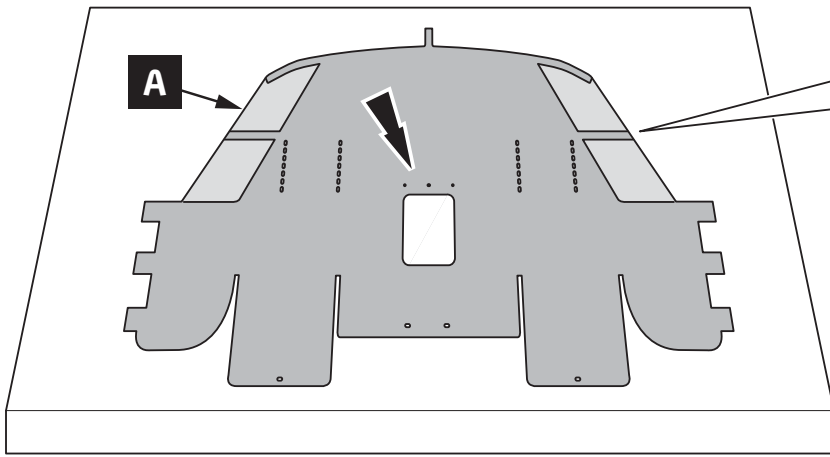

5

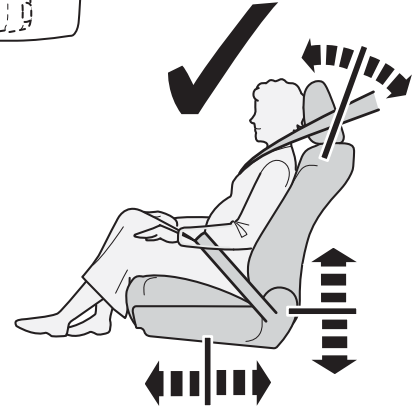
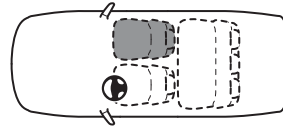
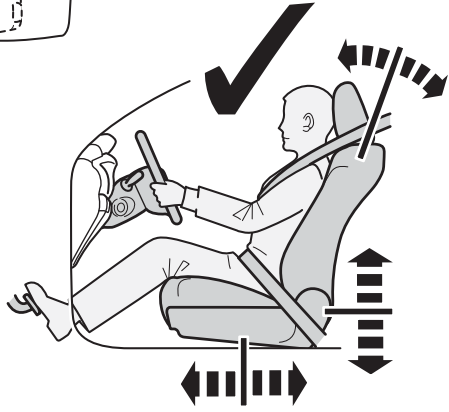
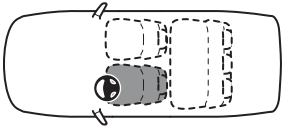

6

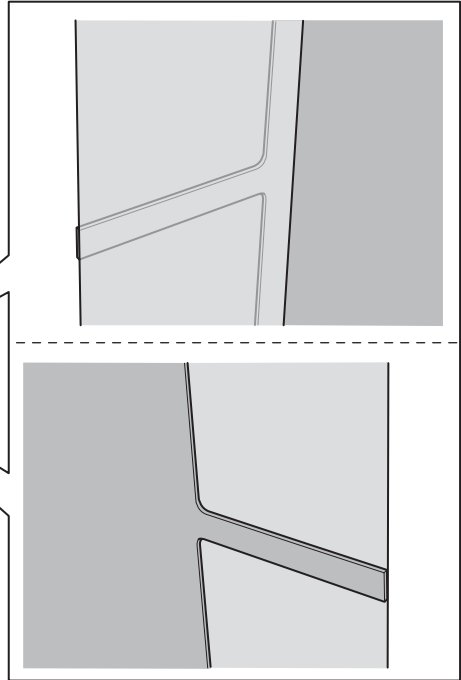
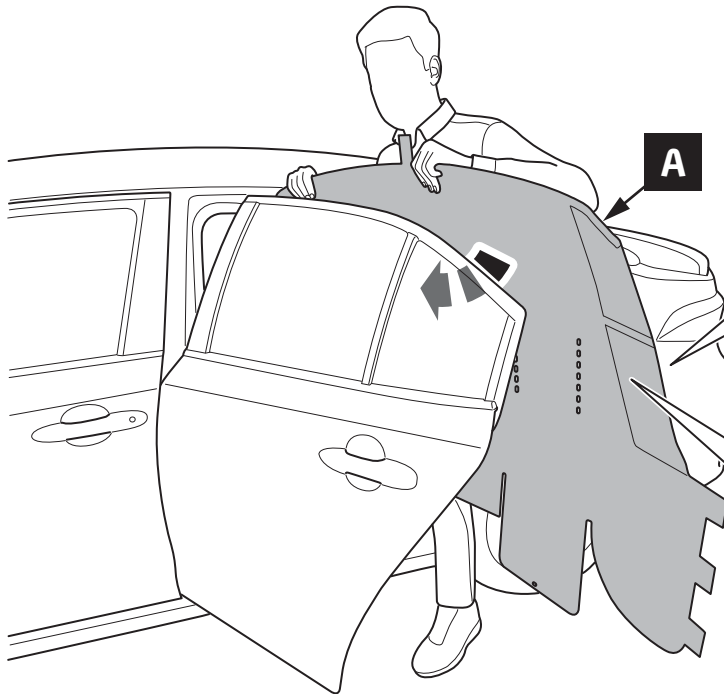

7

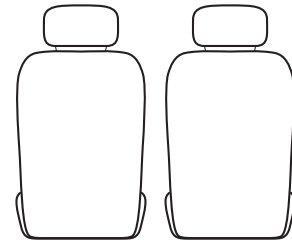
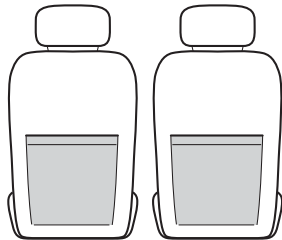

8

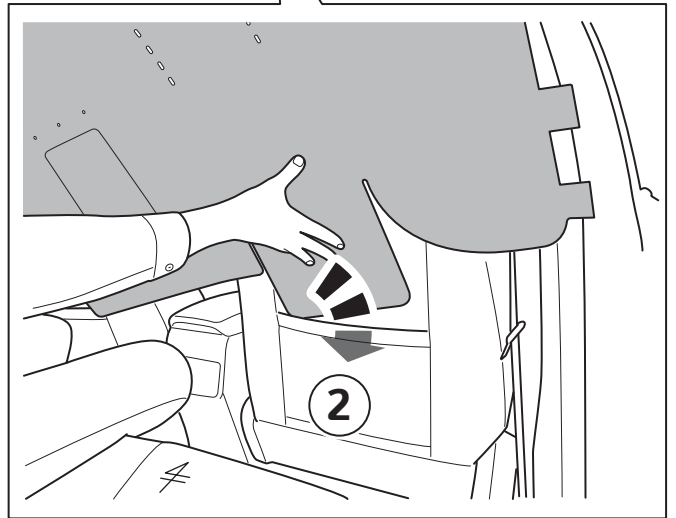
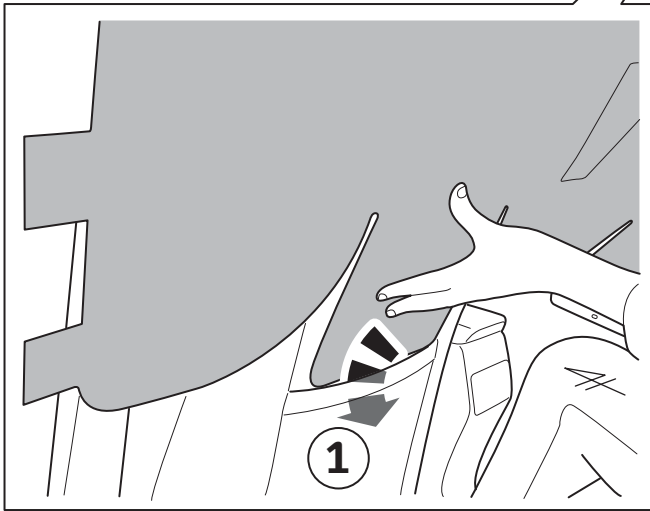
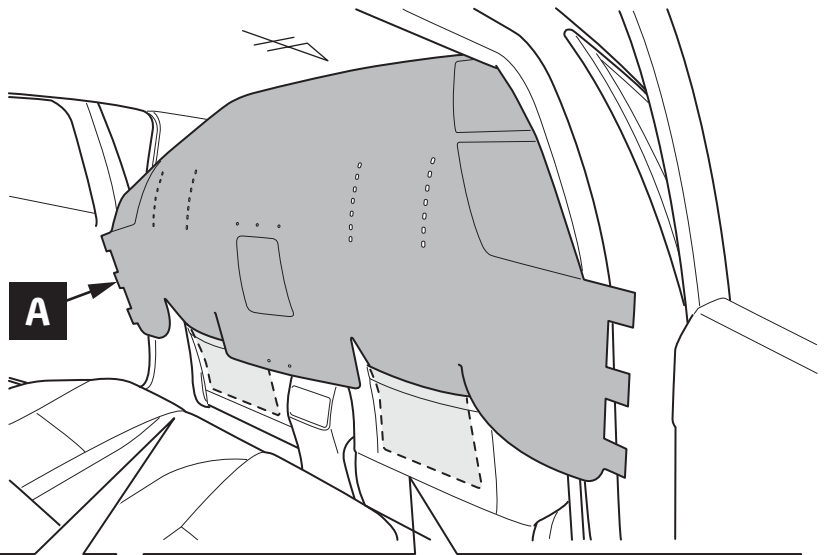

9

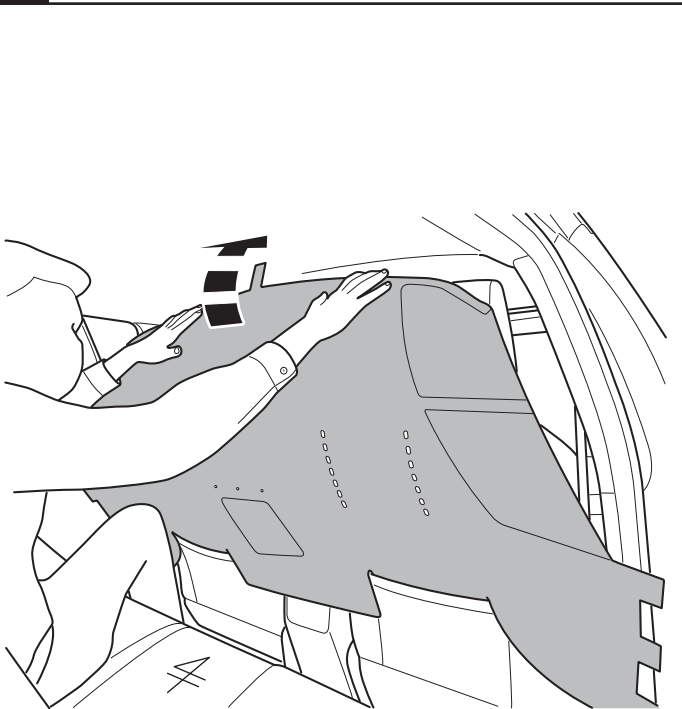

10

LHS=RHS

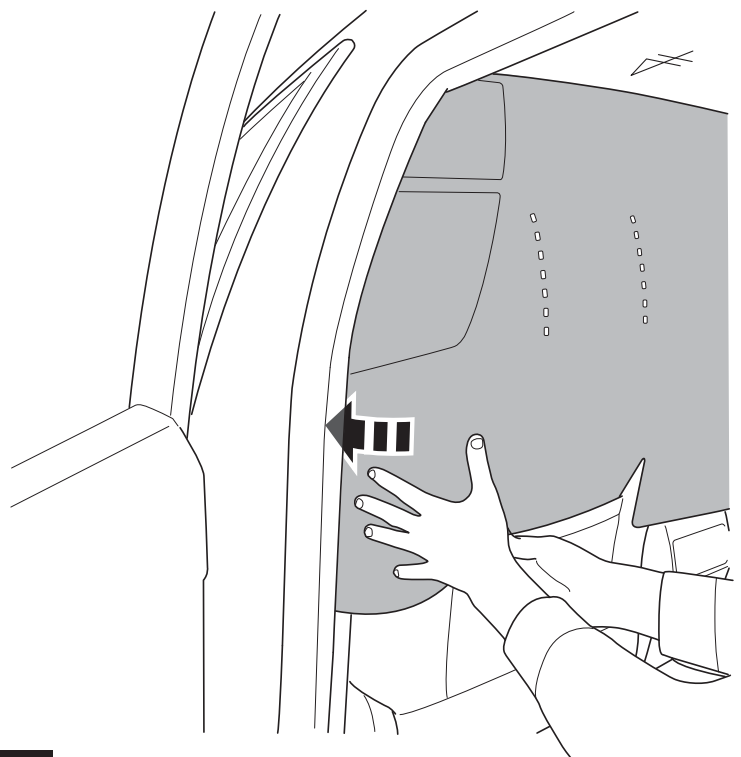

11

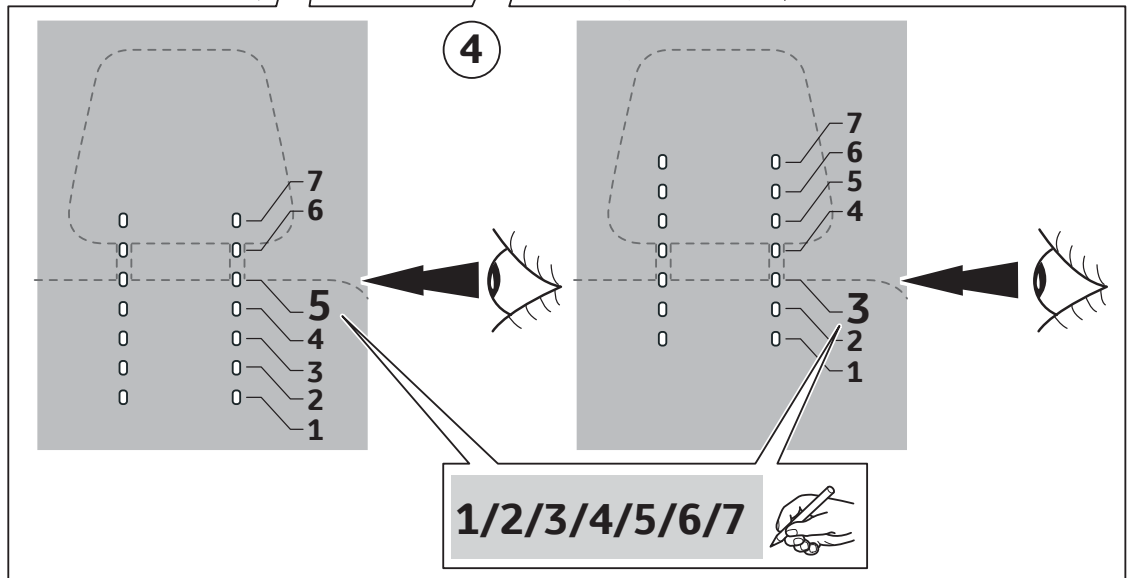
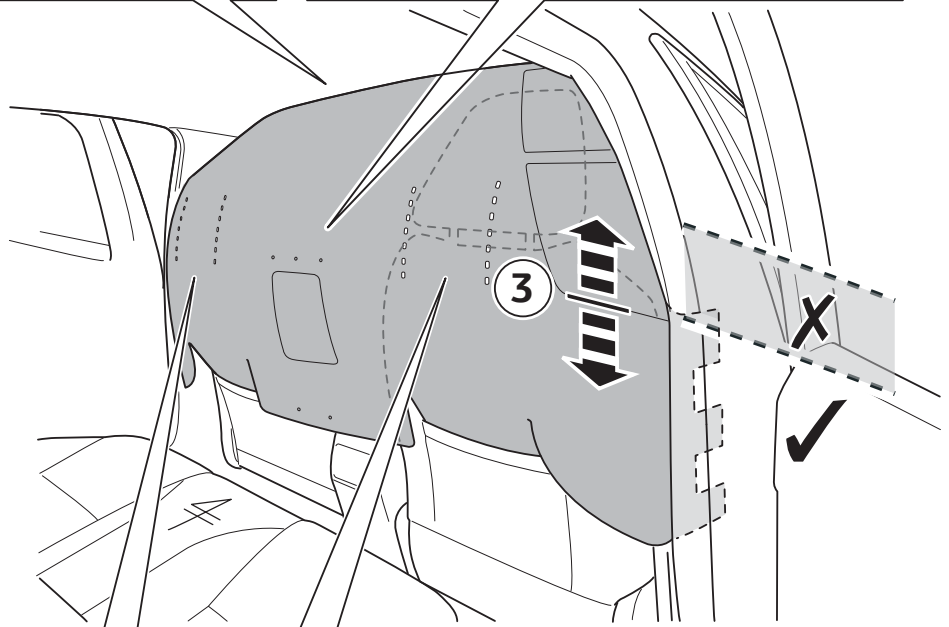
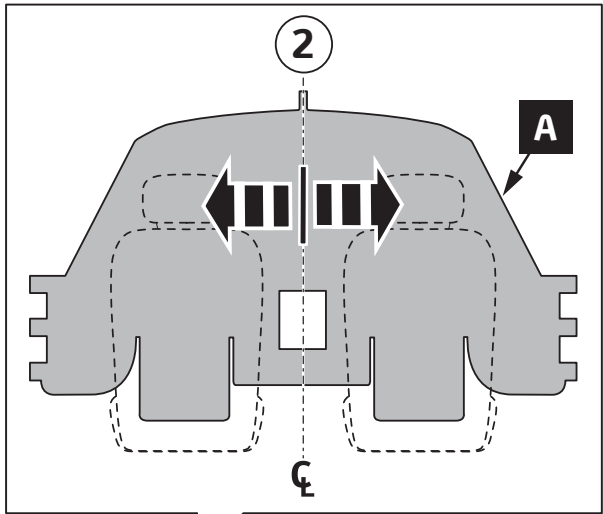
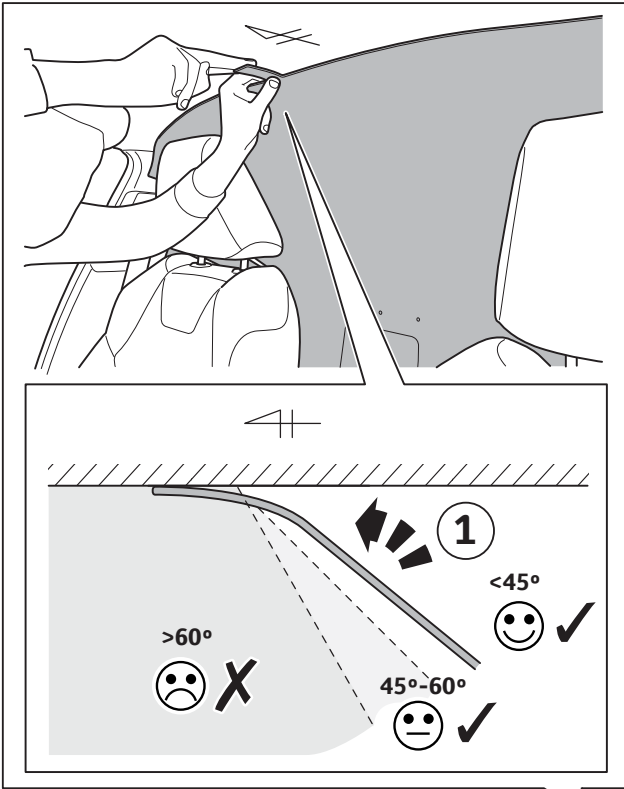

LHS=RHS

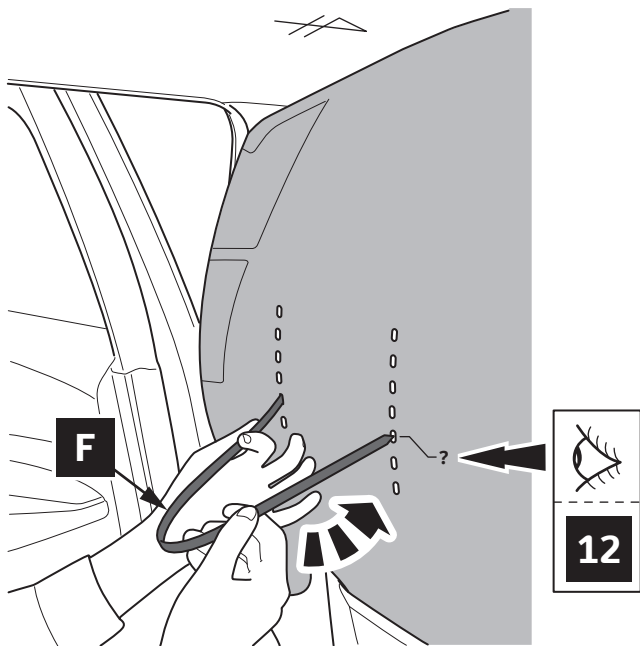

13

LHS=RHS

1

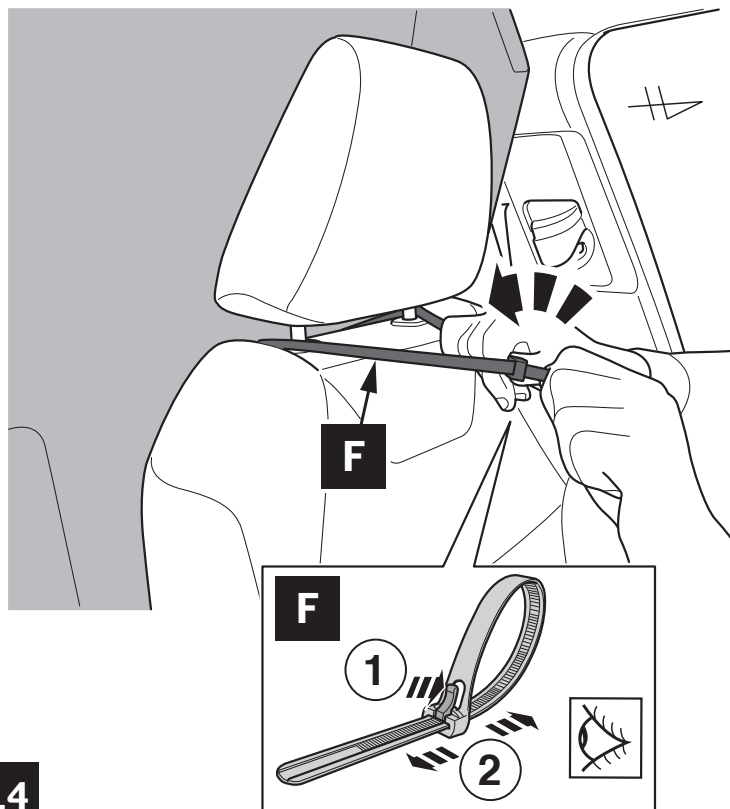

14

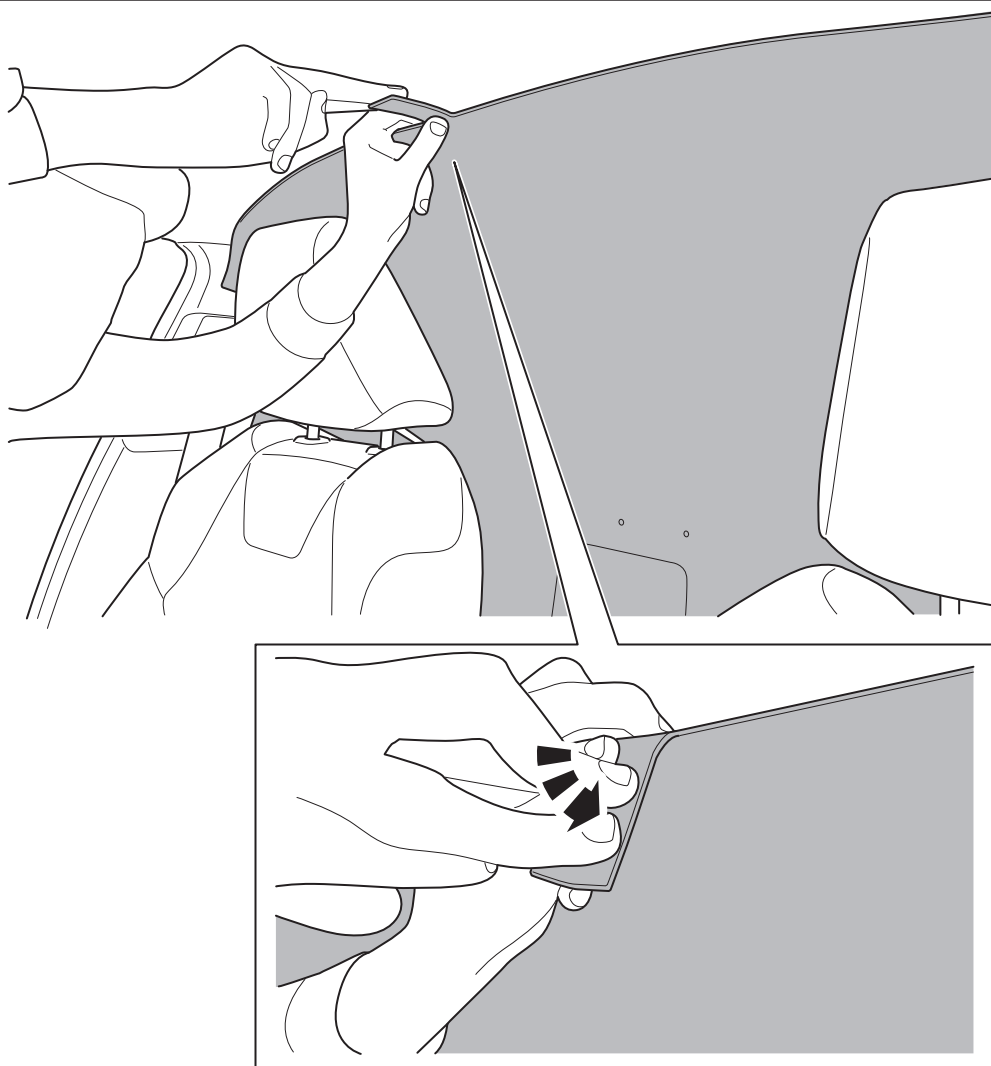

15

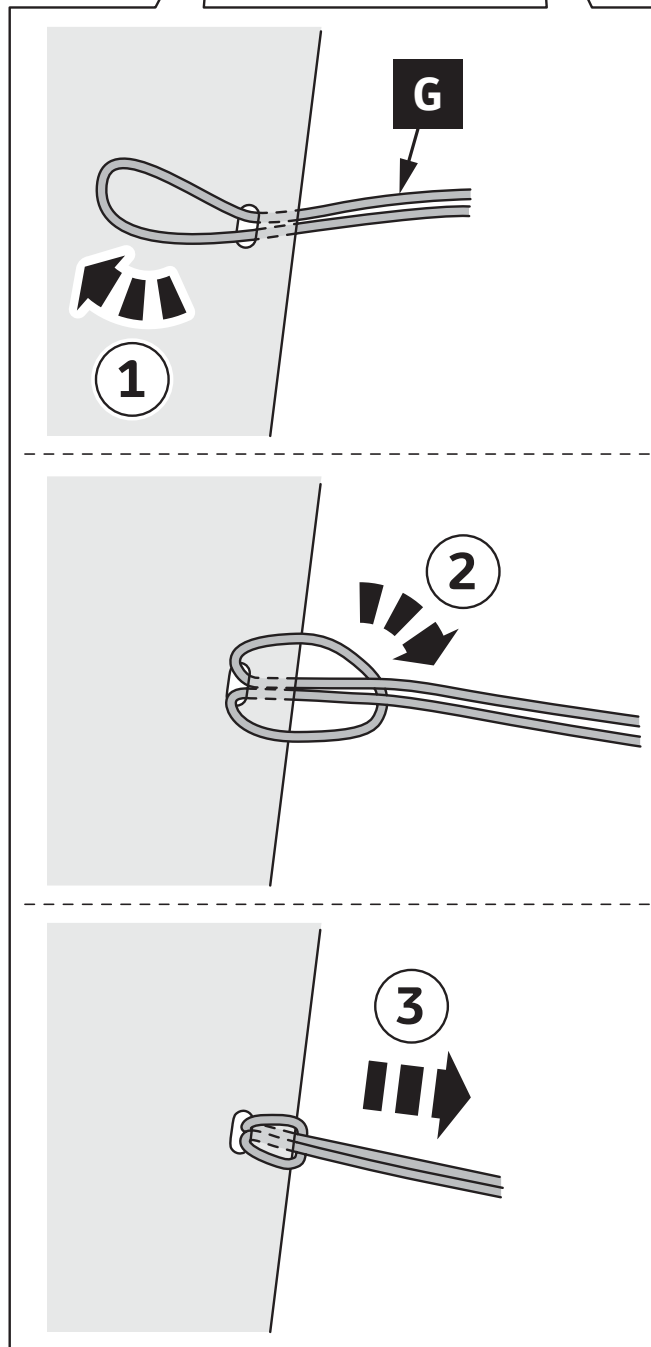
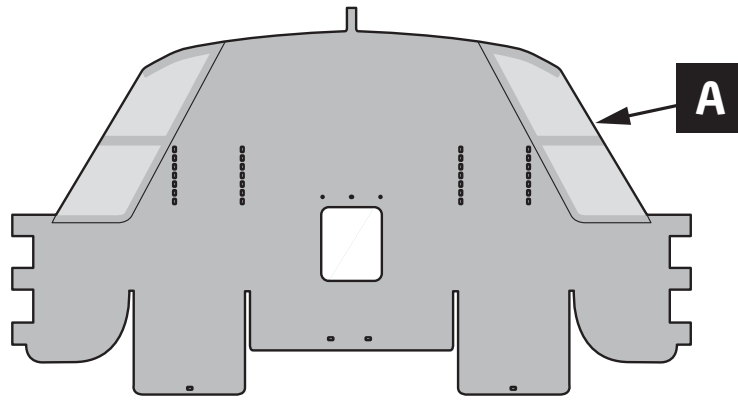

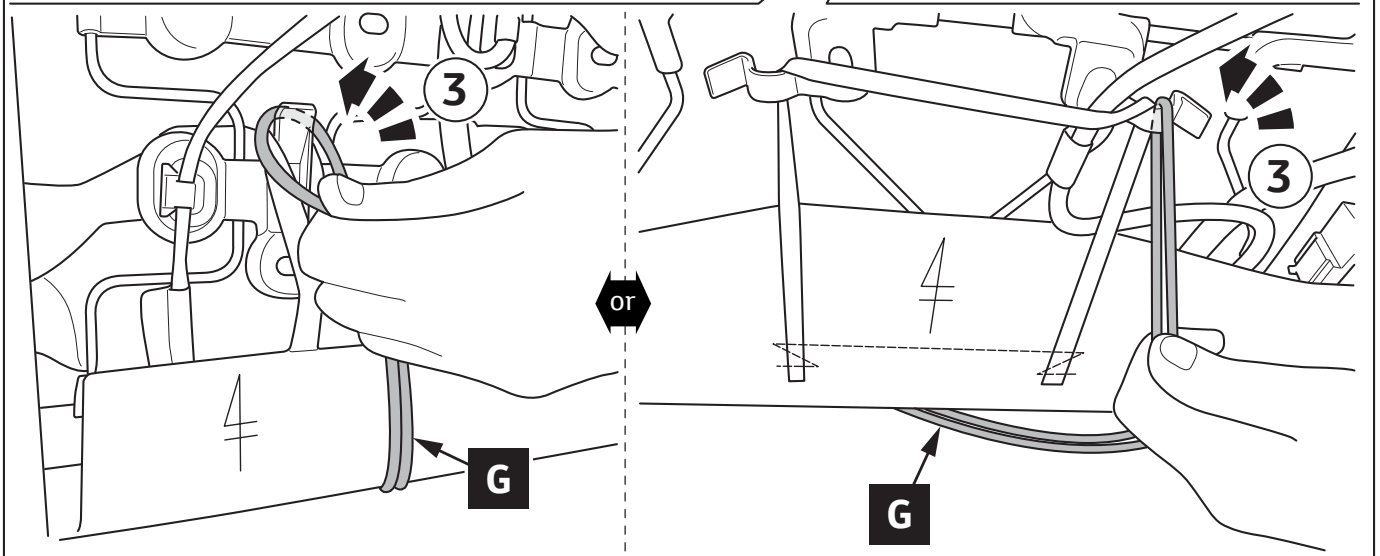
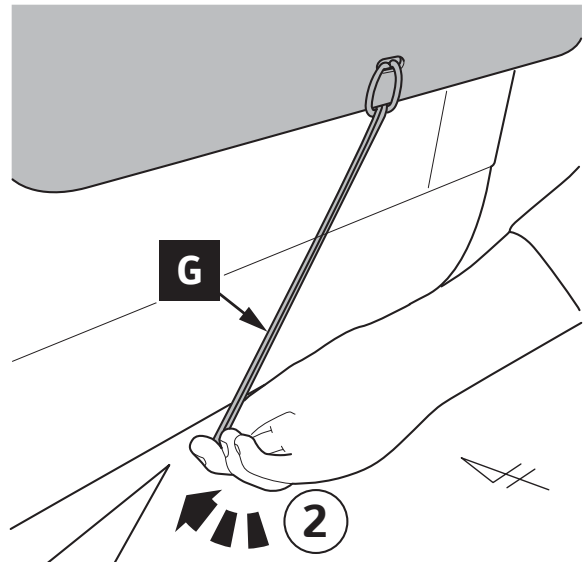
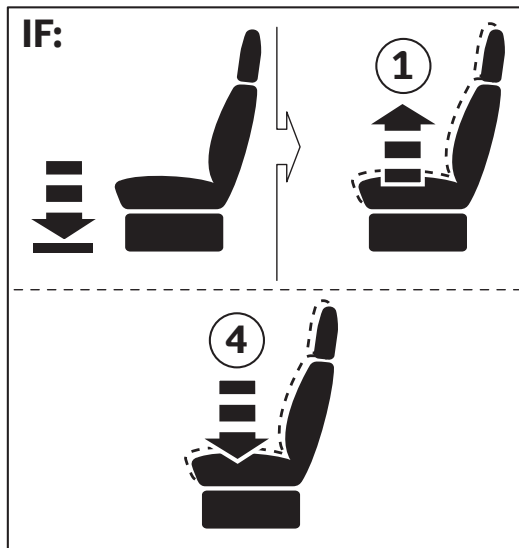
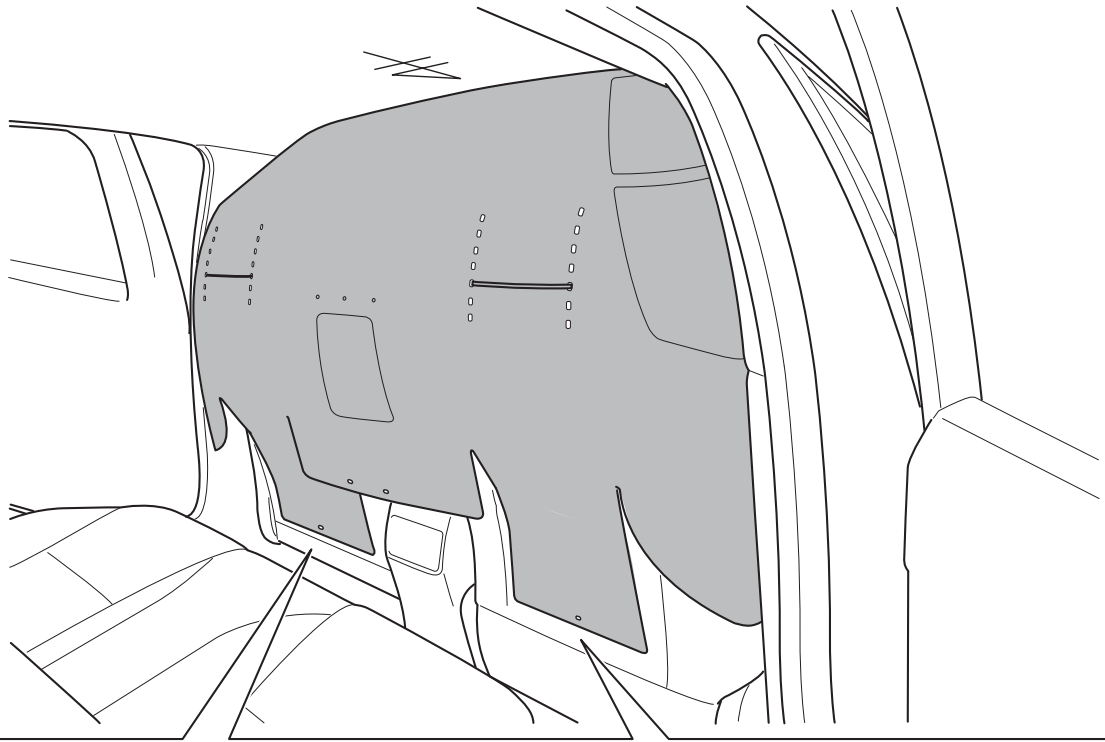

NOT INCLUDED - OPTIONAL

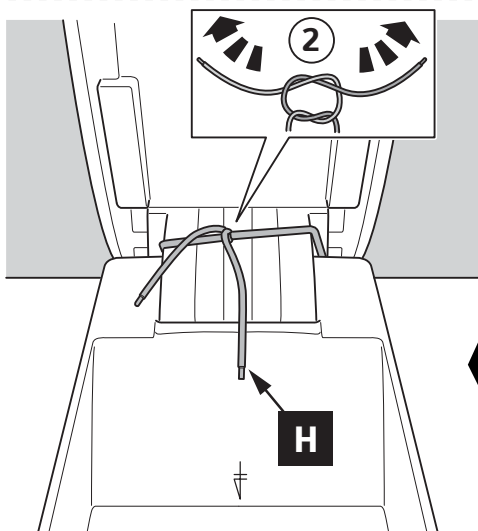
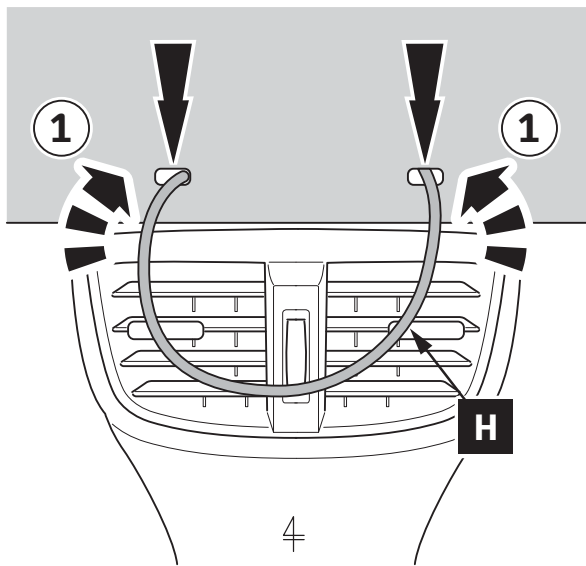
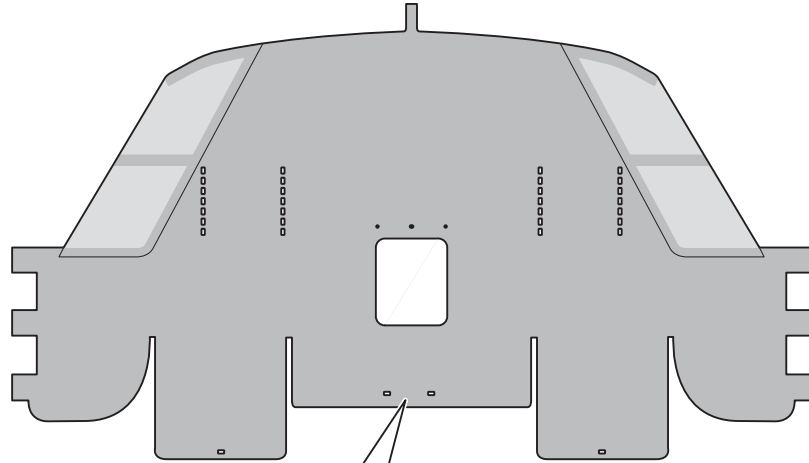
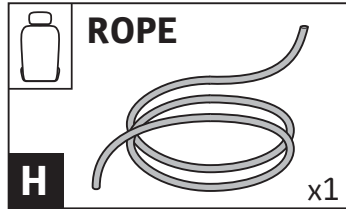

OR

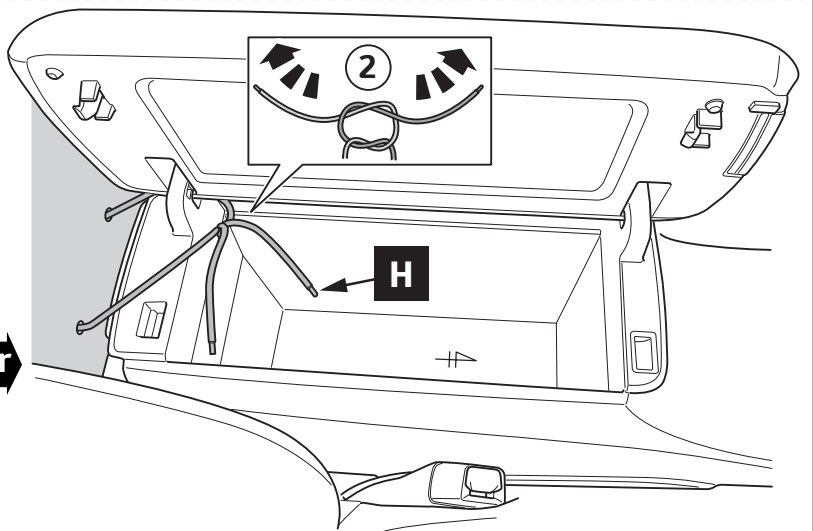

INFORMATION

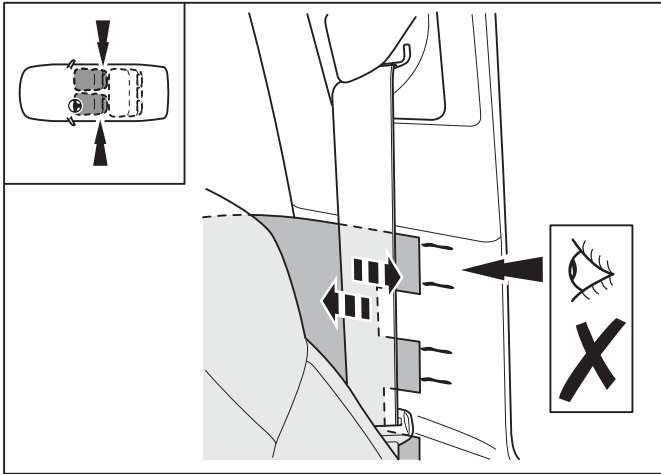

1

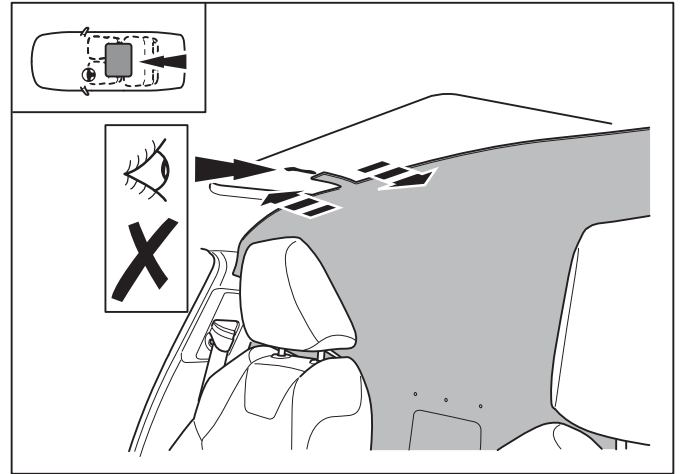
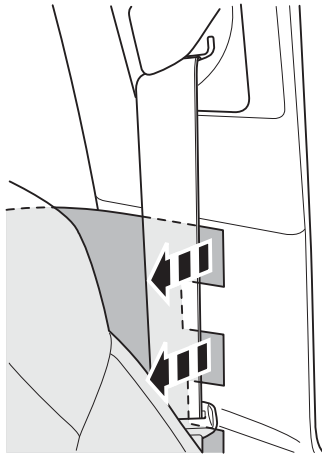

1

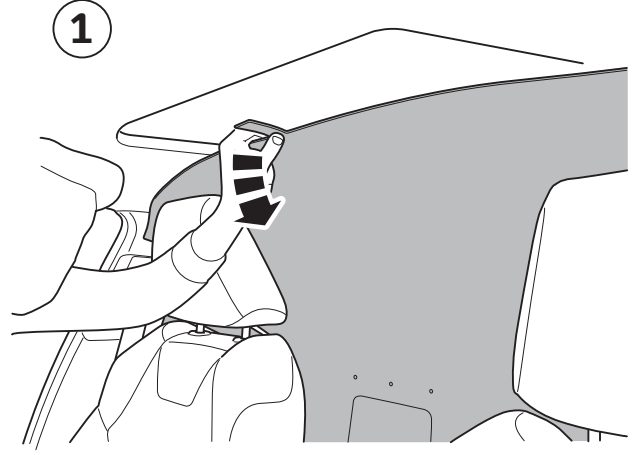

2

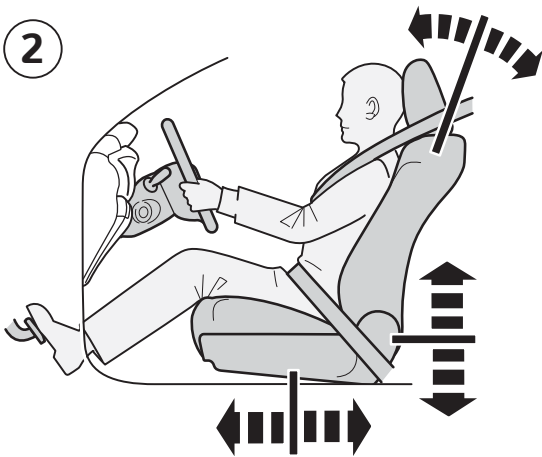

2

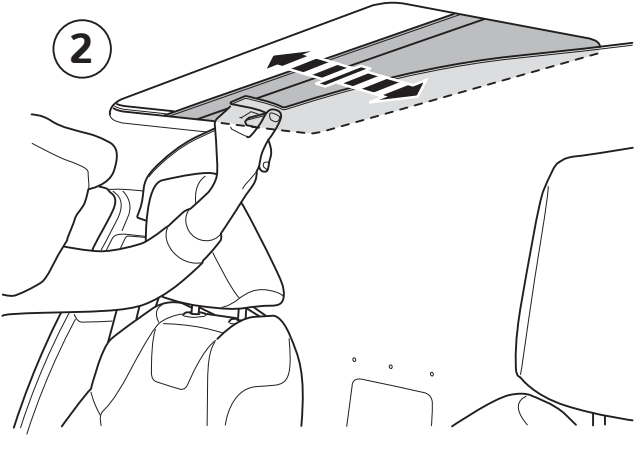

3

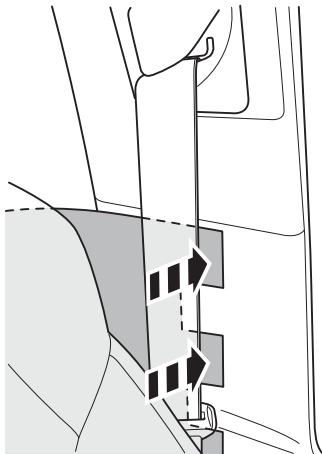

3

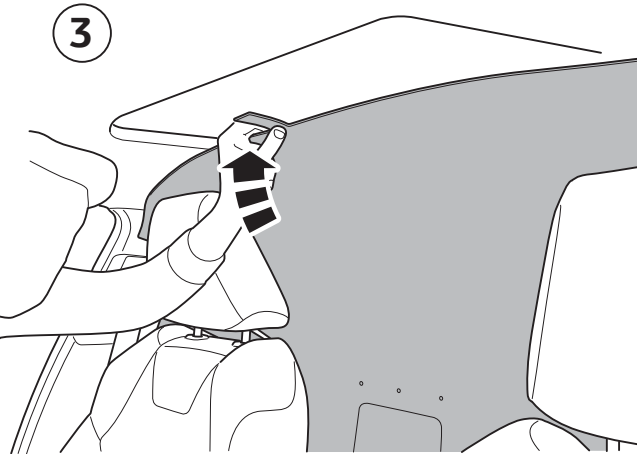

CHECK SHEET

Model/Year	Corolla (HB)	As from 2019/01
	Corolla (TS)	As from 2019/02
	Corolla (Sedan)	As from 2019/01
	Auris	As from 2015/05 - Until 2018/12
	Toyota C-HR	As from 2016/10
	Prius	As from 2015/12
	Prius Plug-in	As from 2016/09
	Camry	As from 2017/09
	UX	As from 2018/10
	UX/UX300e	As from 2020/08

Taxi Divider

VIN n°

DURING INSTALLATION

1

P/N = OK

AFTER INSTALLATION

1

= OK

= OK

2

= OK

Installation Date:

.. / .. / ..

Technician Name & Signature:

Stamp: