



**TOYOTA**

ALWAYS A  
**BETTER WAY**

# Toyota C-HR

## Scuff Plates

Installation Instructions

Model year: 2016/10  
Vehicle code: \*\*\*\*0\*-AH\*\*\*W  
Part number: PW382-10000

Manual reference number: AIM 004 114-0

# Revision record

Rev. No.	Date	Page	Picture	Update	New	Deleted steps

**PW382-10000**

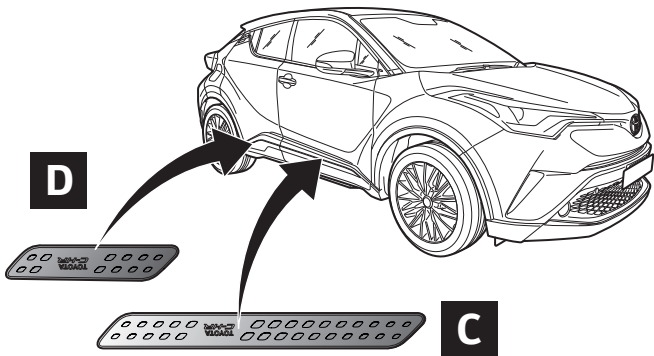

1x

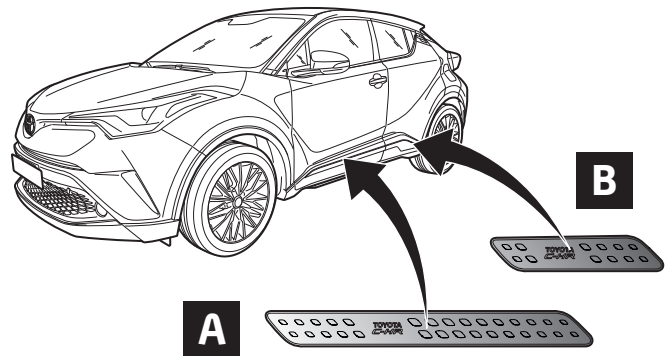

1x

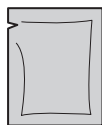
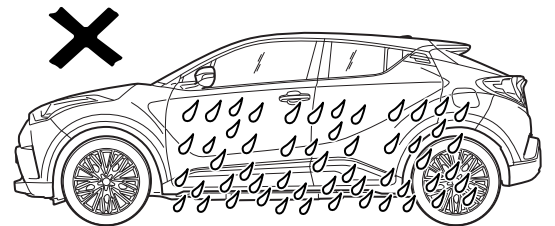
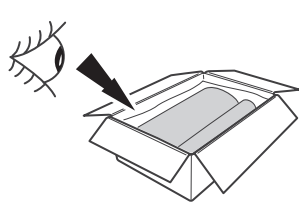
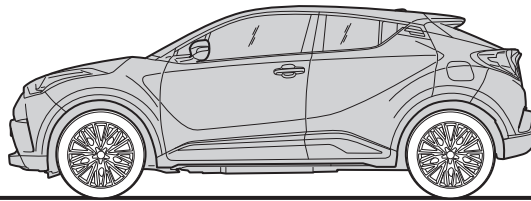
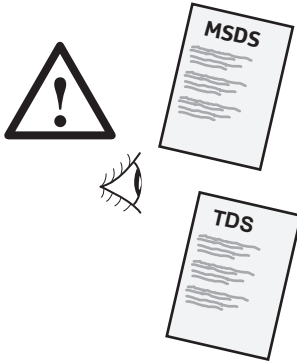

**3M**  
adhesion promoter  
PZ415-00000-00

1x



**CLEANER  
DEGREASER**

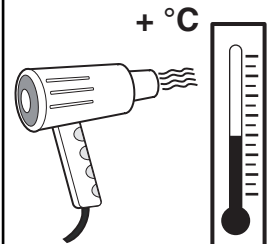
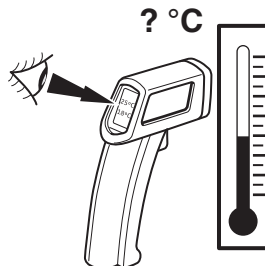

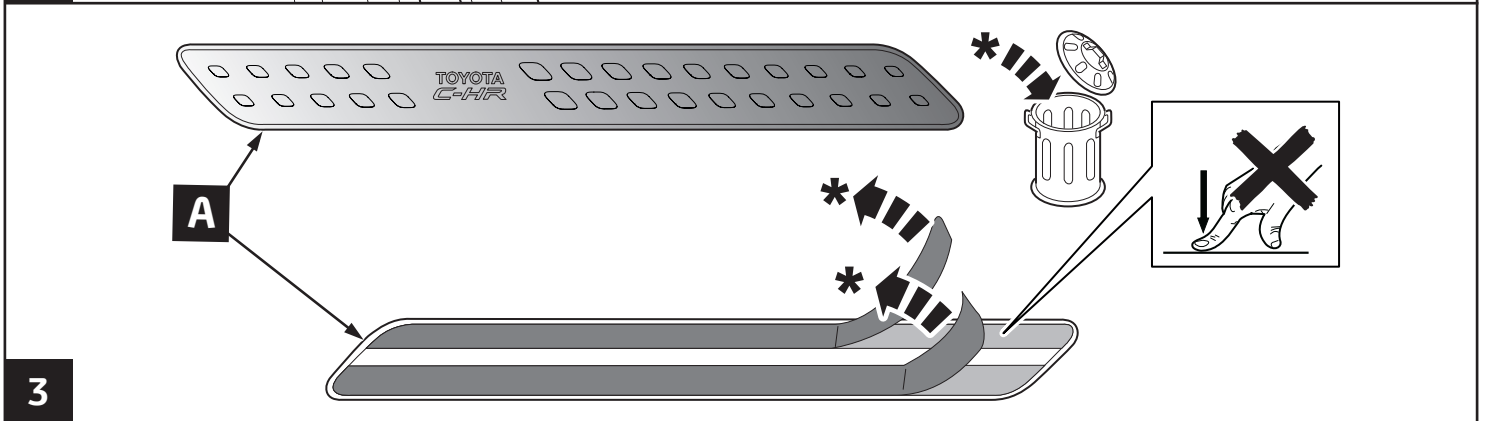
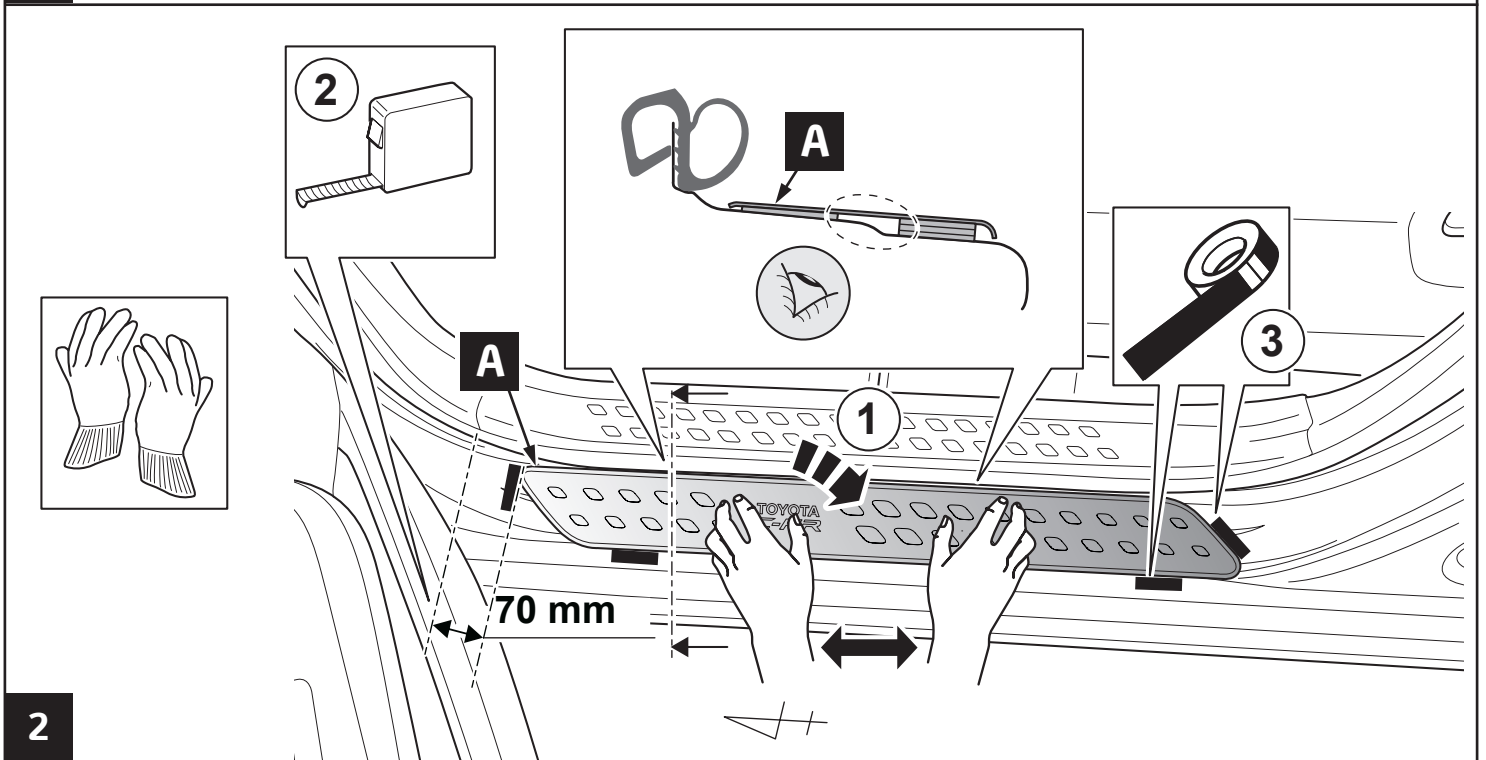
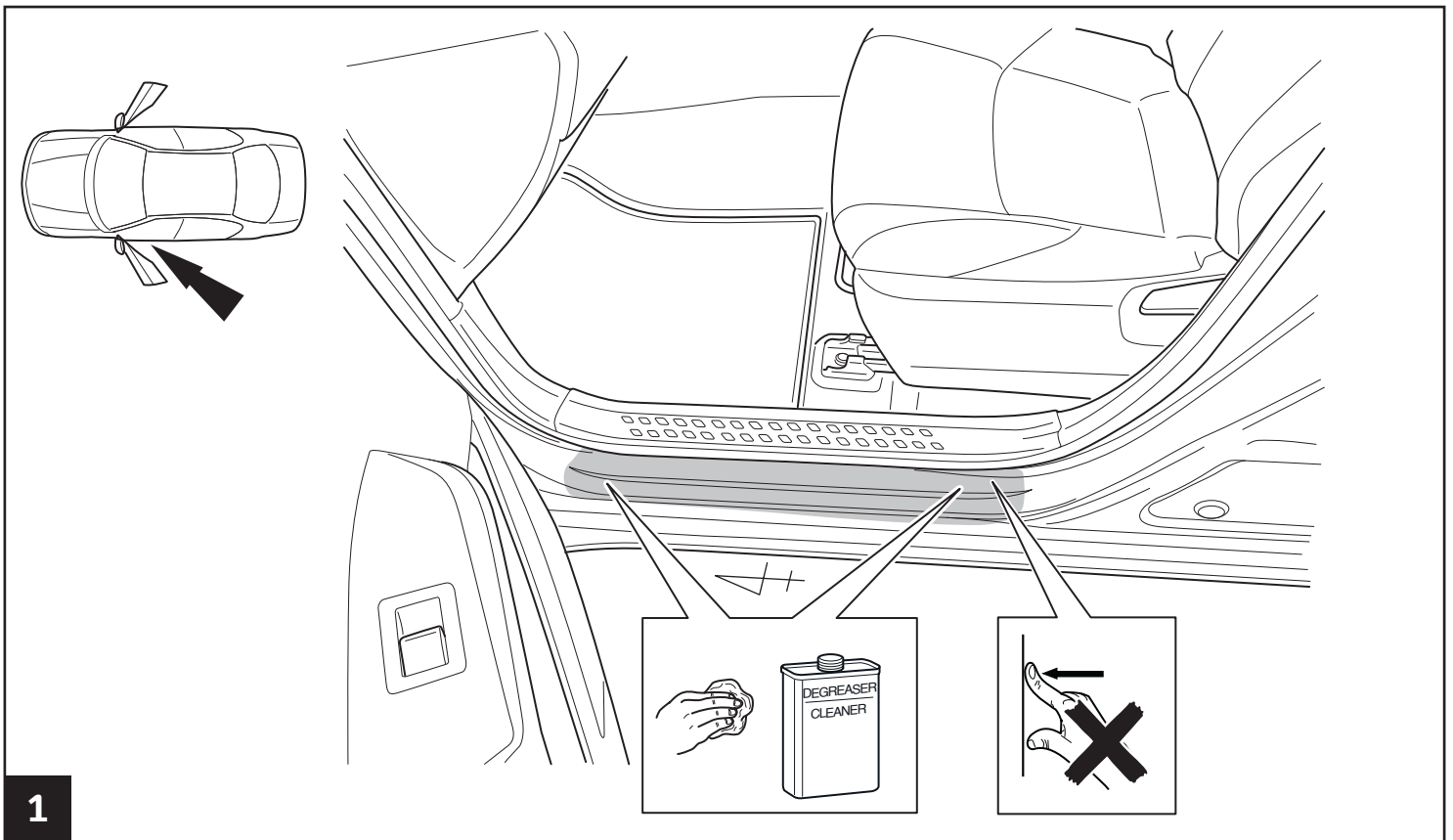

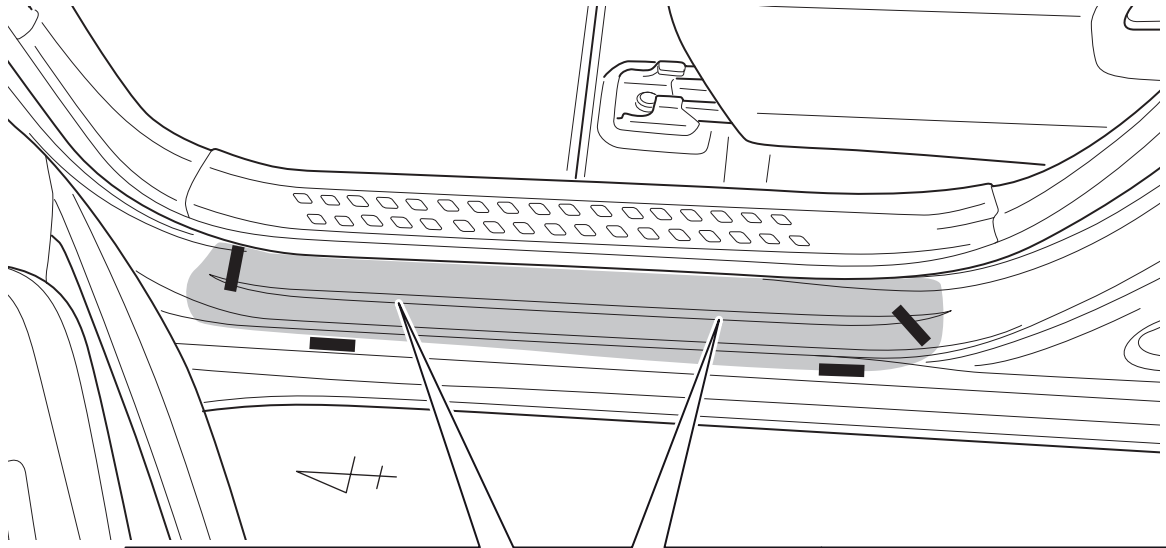

<p>1</p> <p>? °C</p>	<p>? &lt; 20°C → 2</p> <p>20°C &lt; ? &lt; 40°C → 5</p>	<p>2</p> <p>+ °C</p>
<p>3</p> <p>? °C</p>	<p>20°C &lt; ? &lt; 40°C → 5</p>	<p><b>INFO</b></p> <p>4 → 7</p> <p> ✓</p> <p> ✗</p>

4

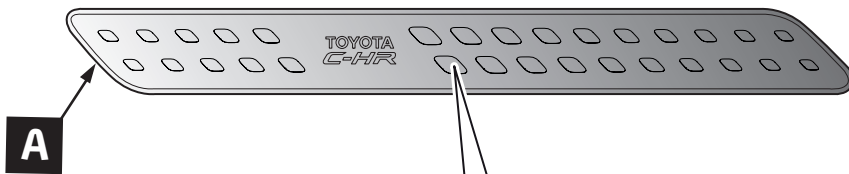

<p>1</p> <p>? °C</p>	<p>? &lt; 20°C → 2</p> <p>20°C &lt; ? &lt; 40°C → 6</p>	<p>2</p> <p>+ °C</p>
<p>3</p> <p>? °C</p>	<p>20°C &lt; ? &lt; 40°C → 6</p>	<p><b>INFO</b></p> <p>5 → 7</p> <p> ✓</p> <p> ✗</p>

5

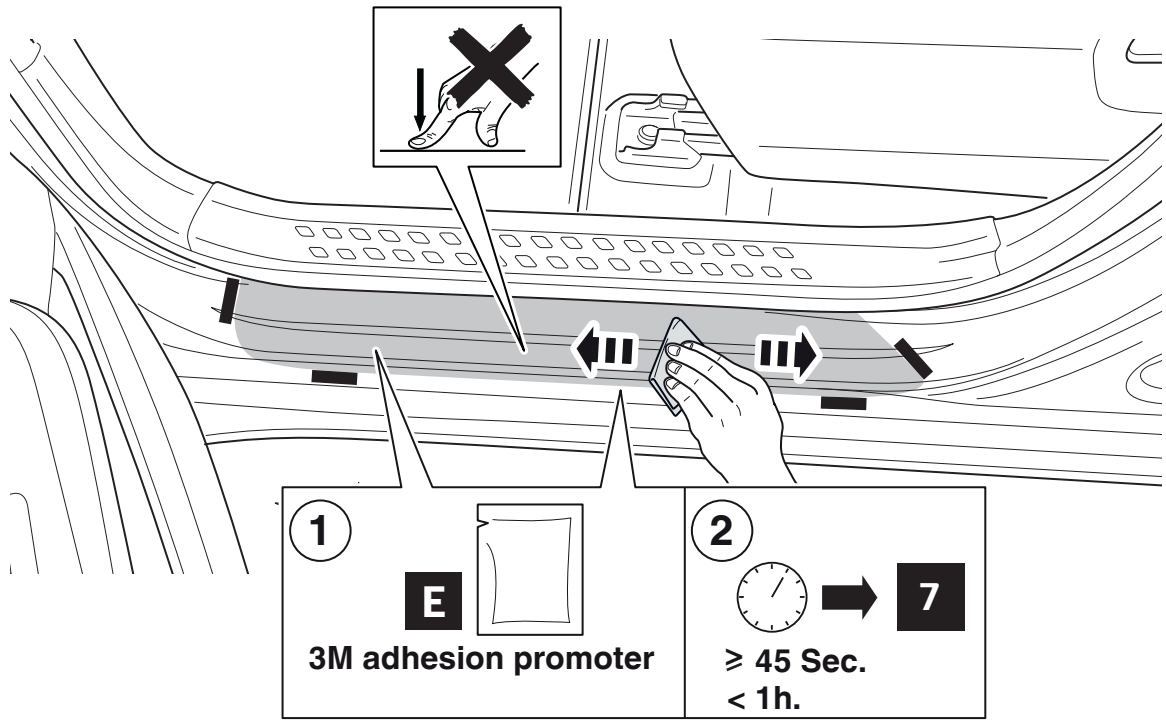

6

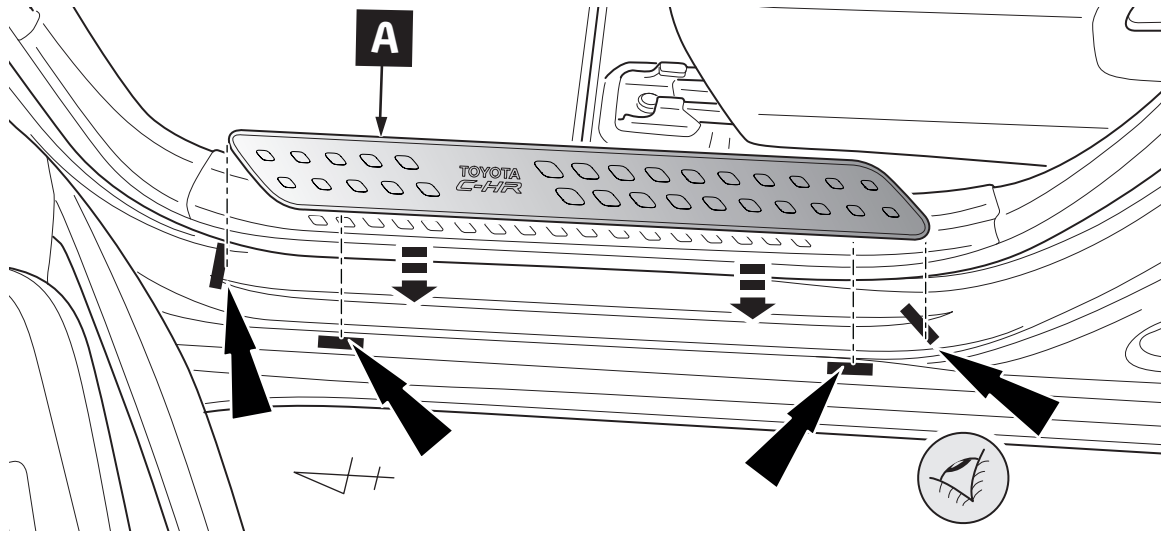
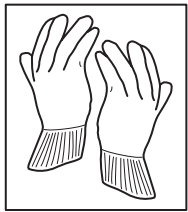

7

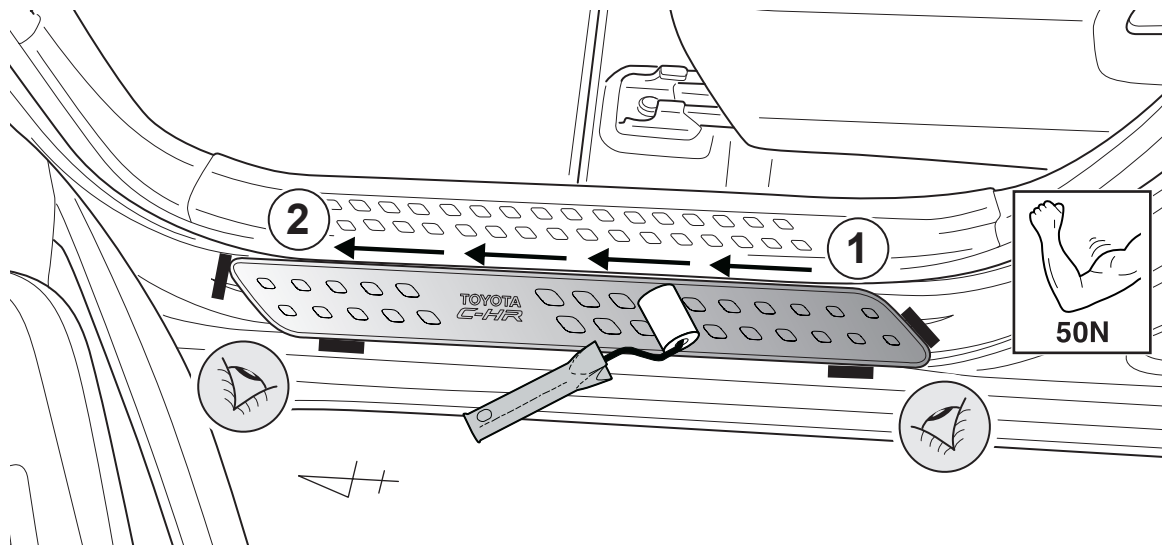

8

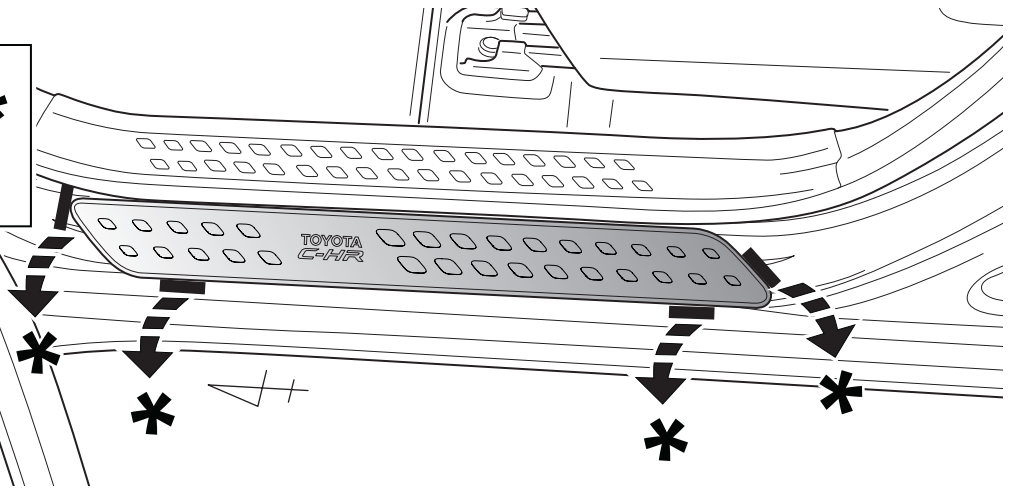
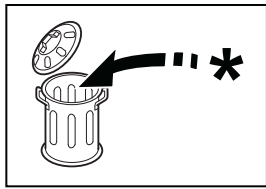

9

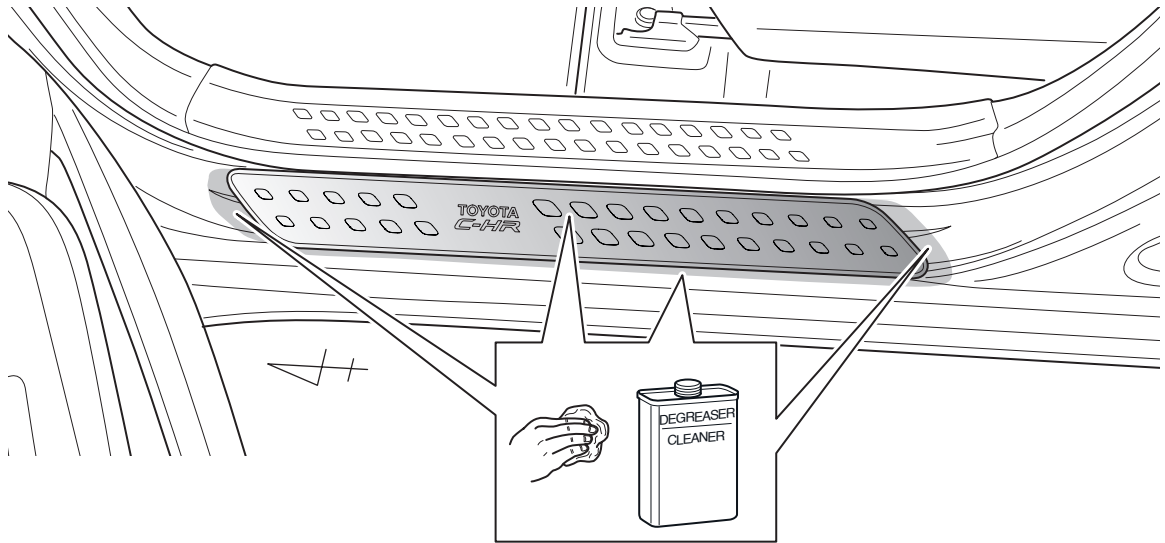



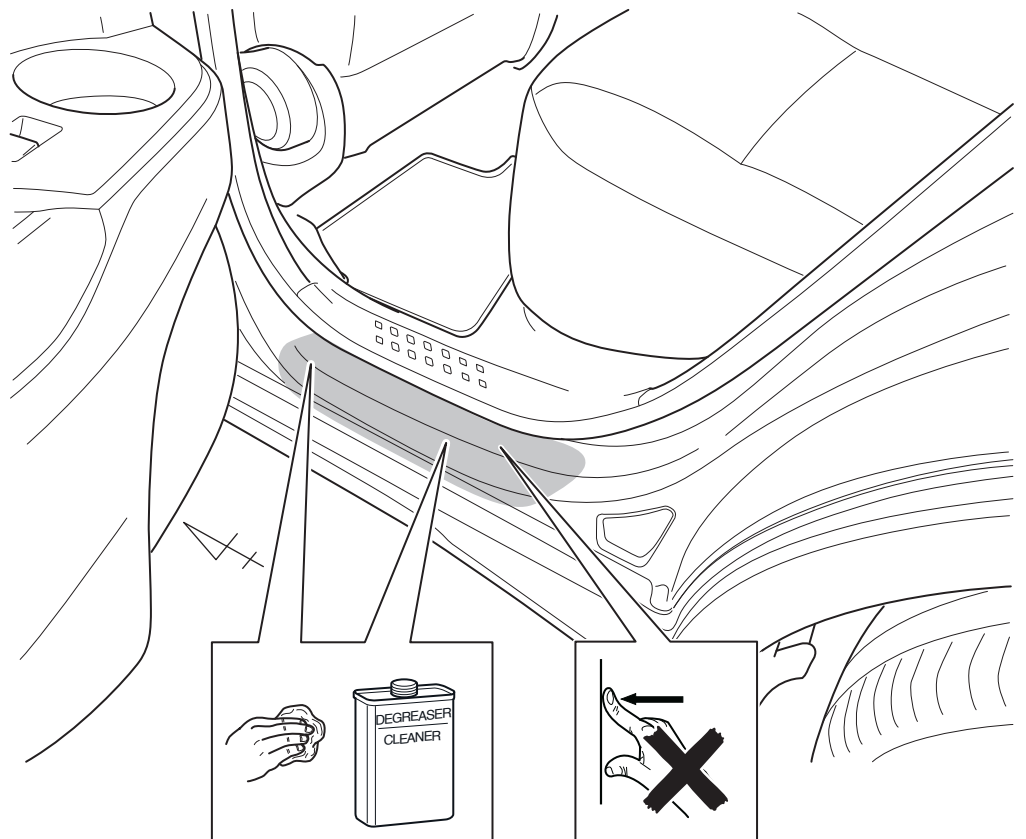
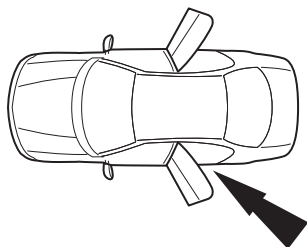

10

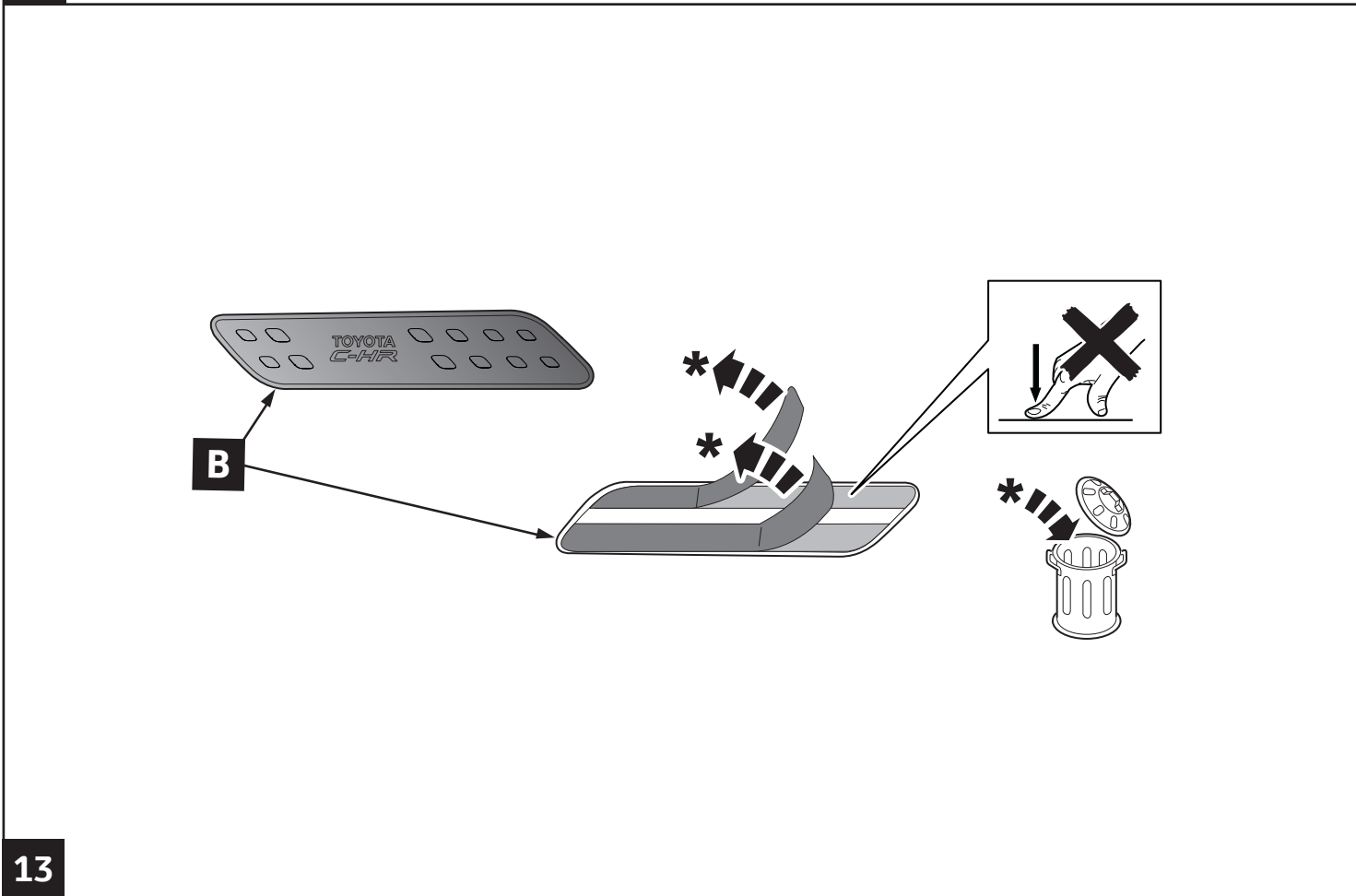
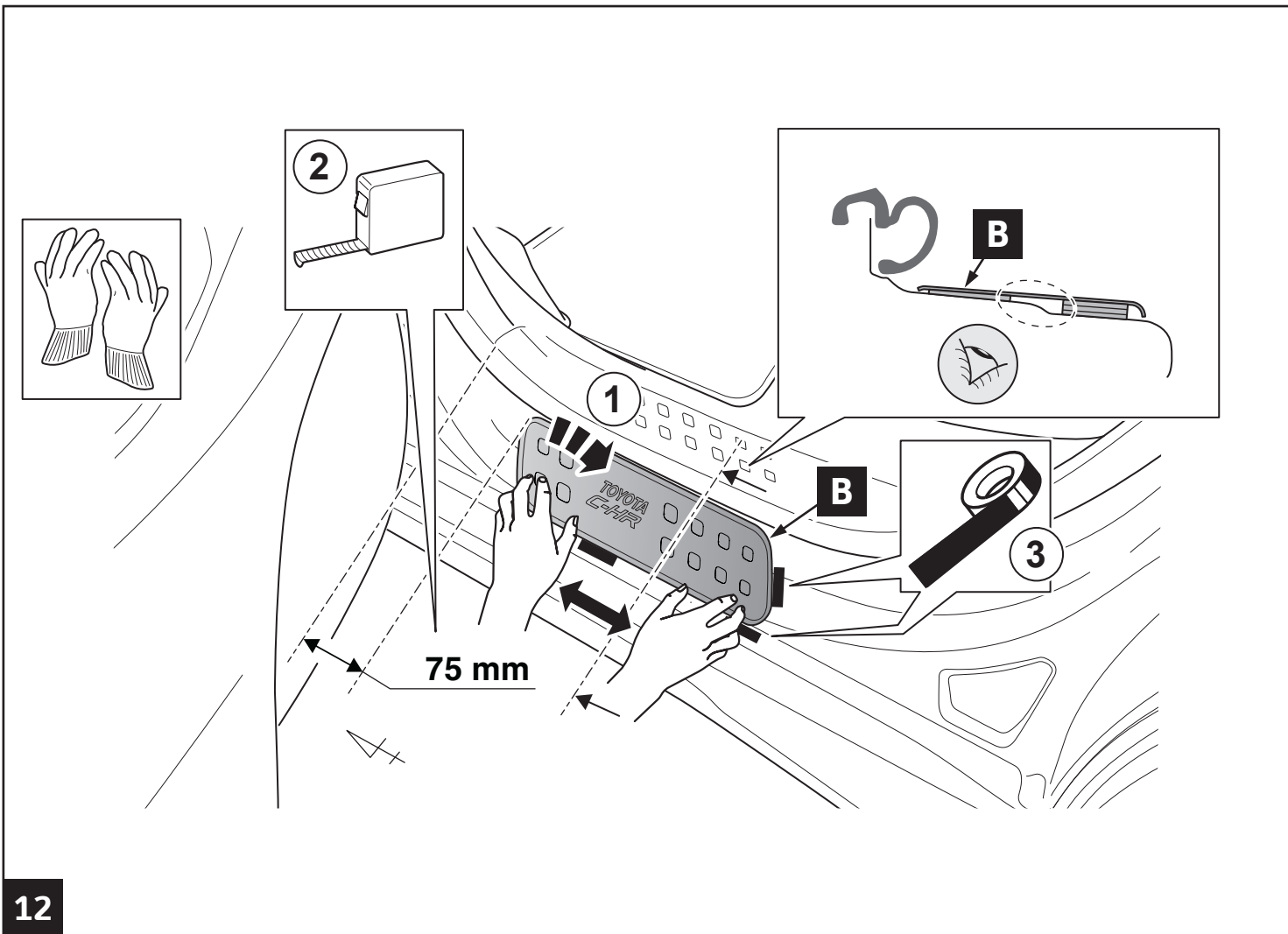

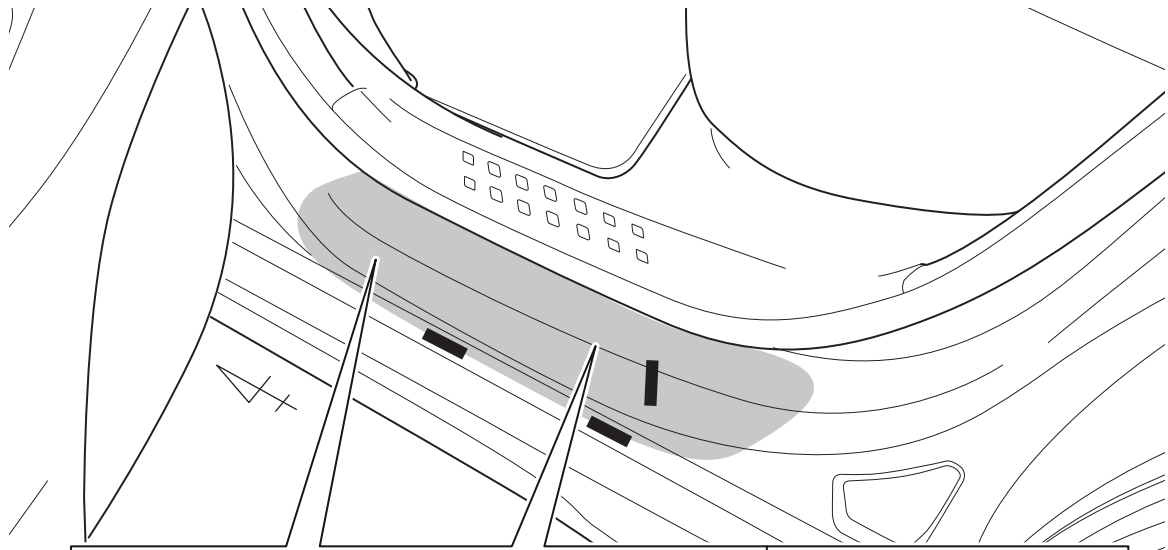
11

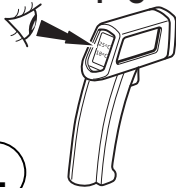
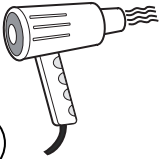
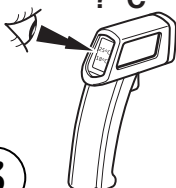







<p>①  ? °C</p> <p>? &lt; 20°C → ②</p> <p>20°C &lt; ? &lt; 40°C → 15</p>		<p>②  + °C</p>
<p>③  ? °C</p> <p>20°C &lt; ? &lt; 40°C → 15</p>		<p><b>INFO</b></p> <p> 14 → 17</p> <p> ✓</p> <p> ✗</p>

14

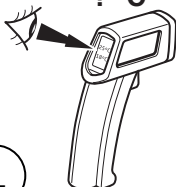
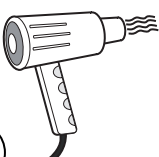
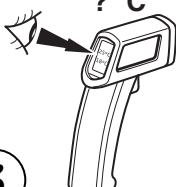

**B**

<p>①  ? °C</p> <p>? &lt; 20°C → ②</p> <p>20°C &lt; ? &lt; 40°C → 16</p>		<p>②  + °C</p>
<p>③  ? °C</p> <p>20°C &lt; ? &lt; 40°C → 16</p>		<p><b>INFO</b></p> <p> 15 → 17</p> <p> ✓</p> <p> ✗</p>

15



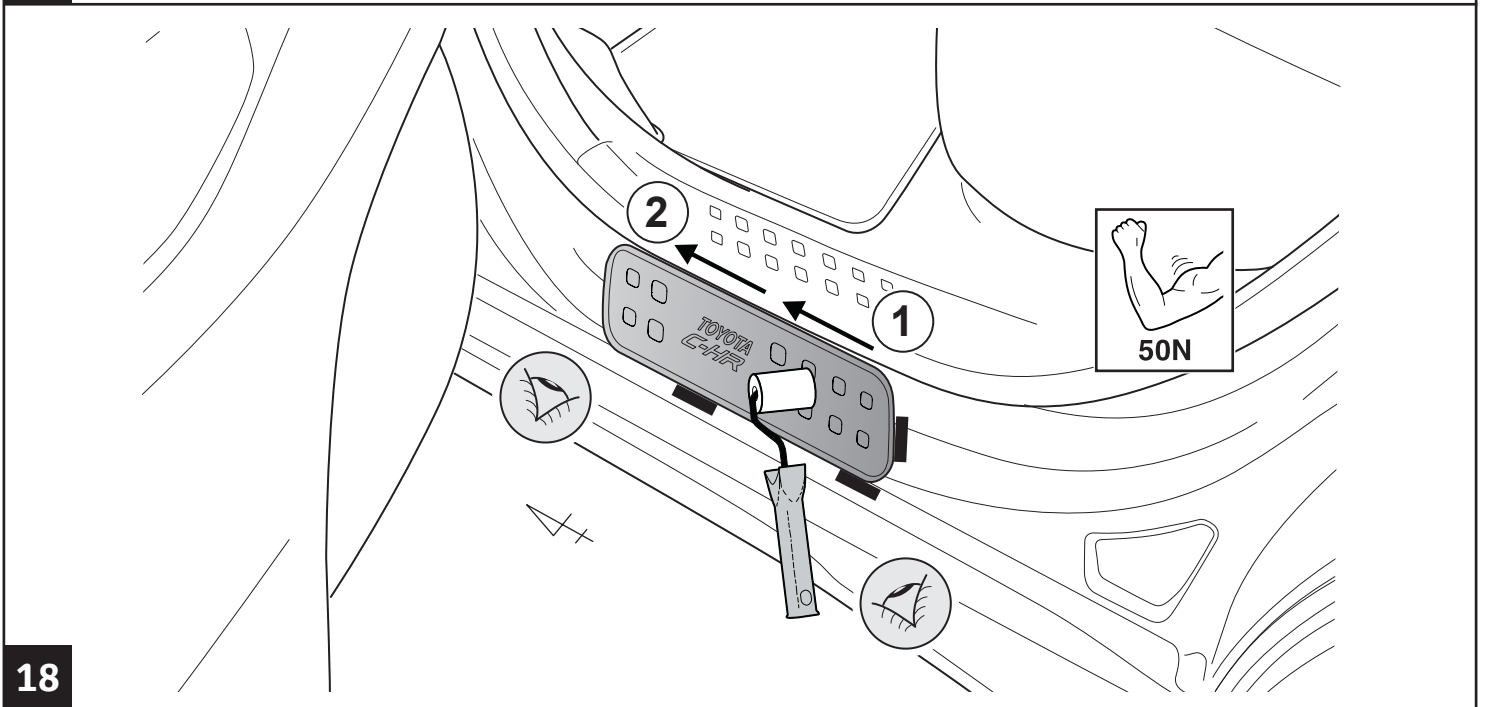
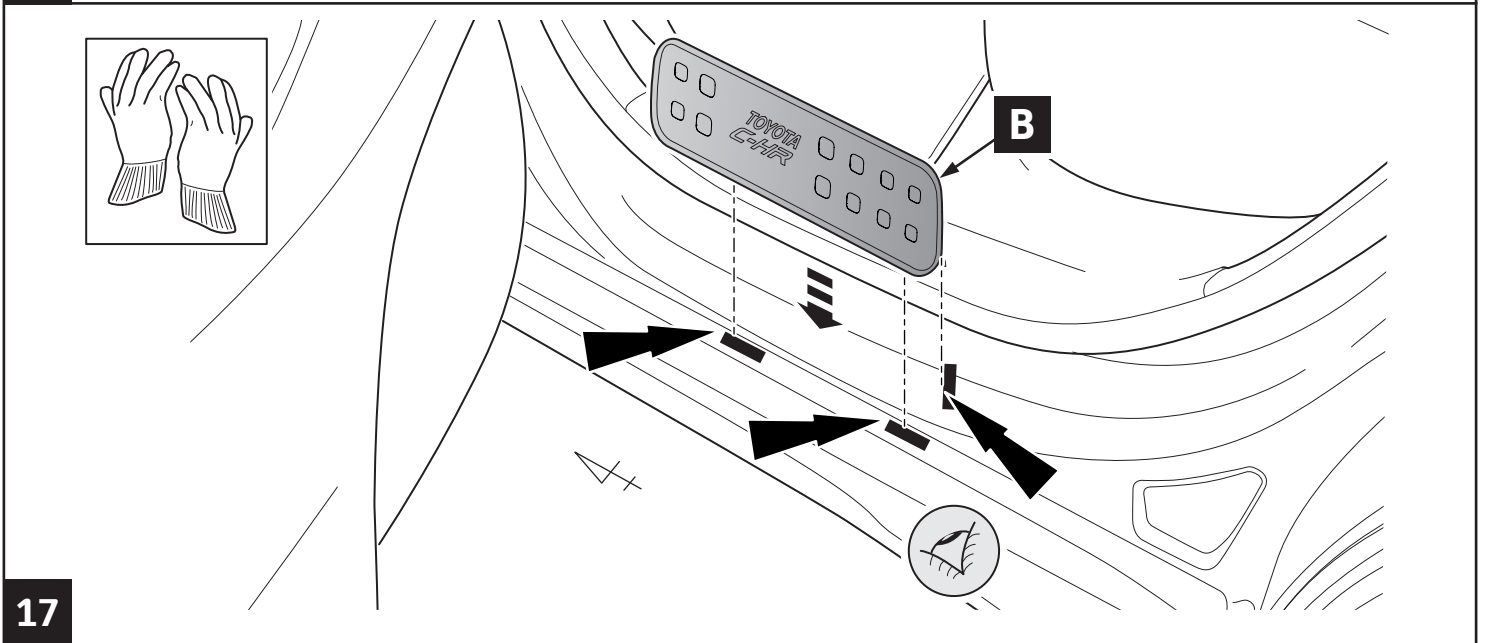
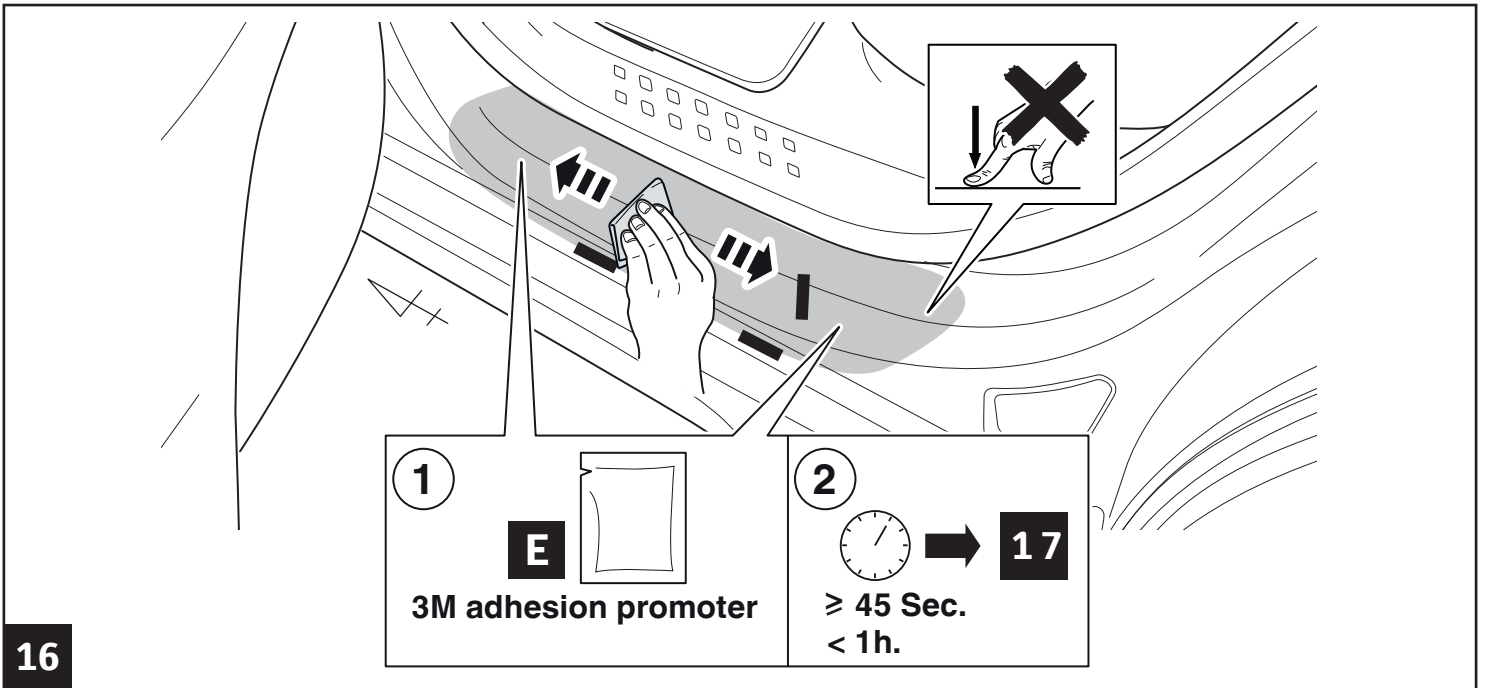

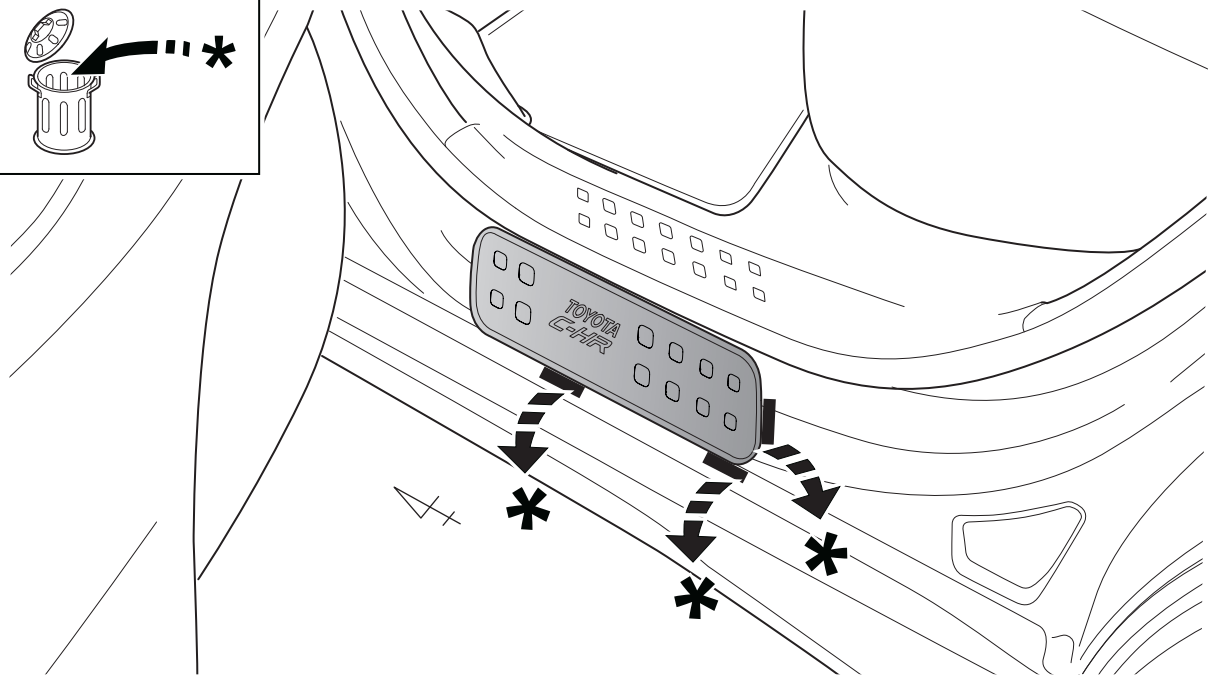
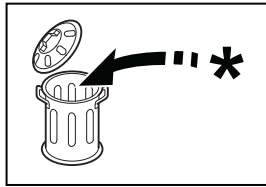

19

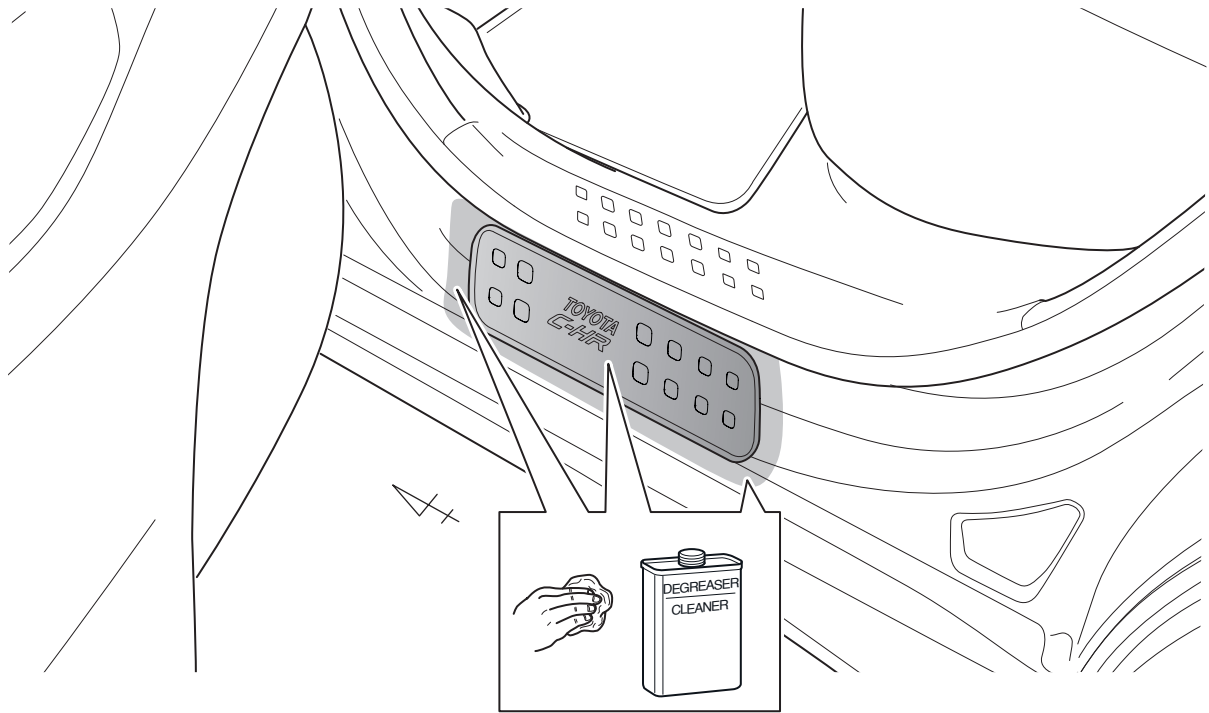

20

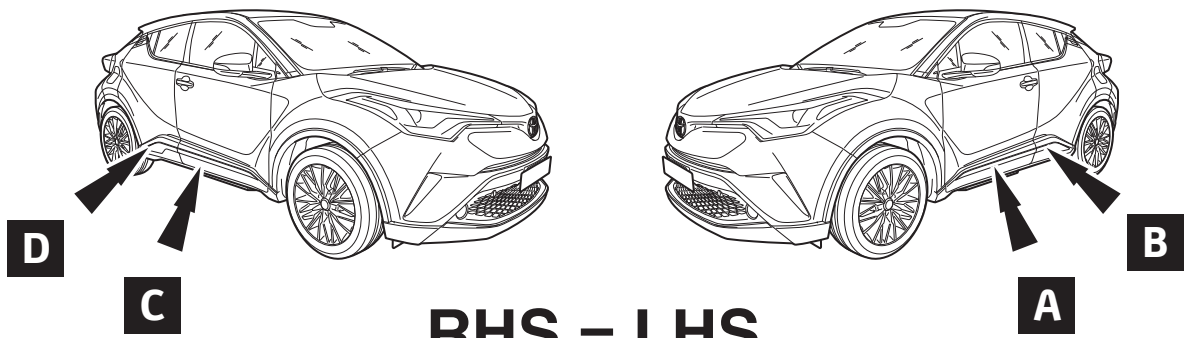

21

# CHECK SHEET



**TOYOTA**

Model / Year

**Toyota C-HR  
2016/10**

**Scuff Plates**

VIN n°

ALWAYS A  
BETTER WAY

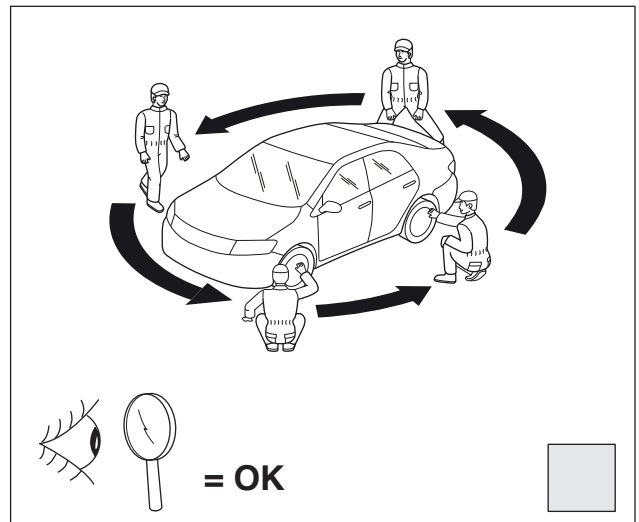
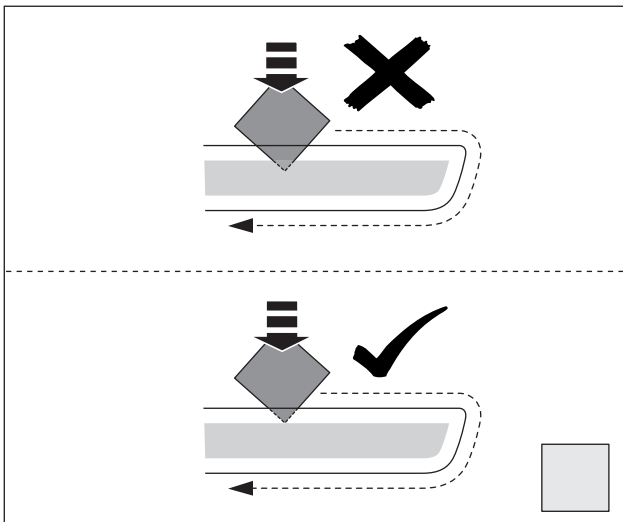
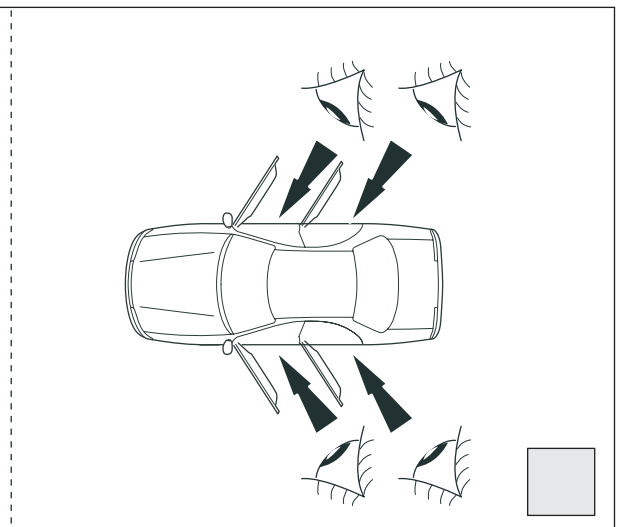
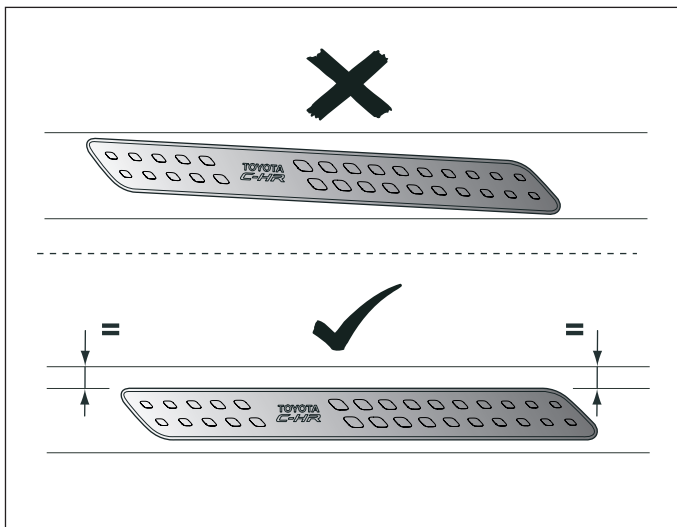
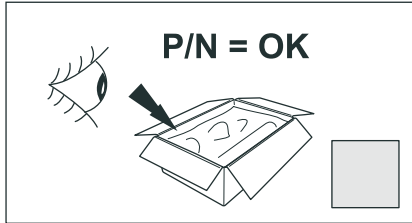

Installation Date:

... / ... / ...

Technician Name & Signature:

Stamp: