



**TOYOTA**

ALWAYS A  
**BETTER WAY**

# All Models

## Long Life Body Protector







Installation Instructions

Part number: PZ41A-BP001-80

Manual reference number: AIM 002 616-5

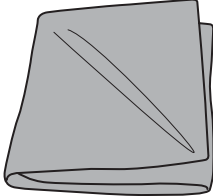
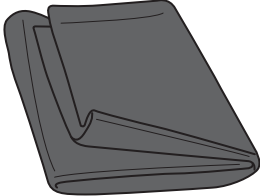
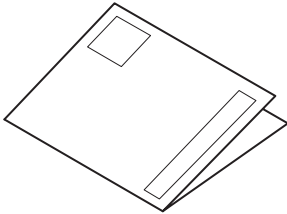
# Revision record

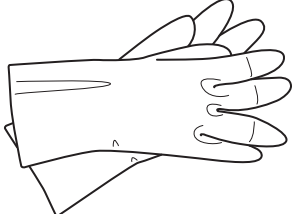
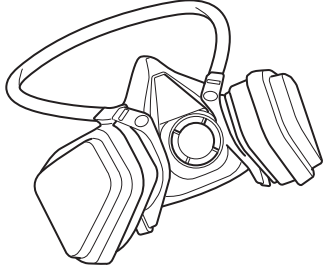
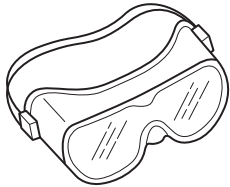
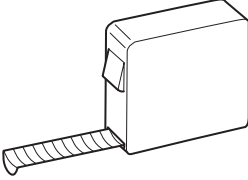
Rev. No.	Date	Page	Picture	Update	New	Deleted steps
3	13-05-2013	5	6	X		
4	13-03-2019	4-6	3, 5, 7, 10	X		
Rev. No.	Date	Page	Step	Remarks		
5	26-08-2019	7	11	Sticker update		

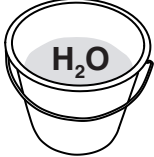
<p><b>A</b></p>  <p>1x</p>	<p><b>B</b></p>  <p>1x</p>	
<p><b>C</b></p>  <p>White</p> <p>1x</p>	<p><b>D</b></p>  <p>Yellow</p> <p>1x</p>	<p><b>E</b></p>  <p>Grey</p> <p>1x</p>
<p><b>F</b></p>  <p>1x</p>	<p><b>G</b></p>  <p>1x</p>	<p><b>H</b></p>  <p>1x</p>
		
 <p>(3x) Microfiber</p>		

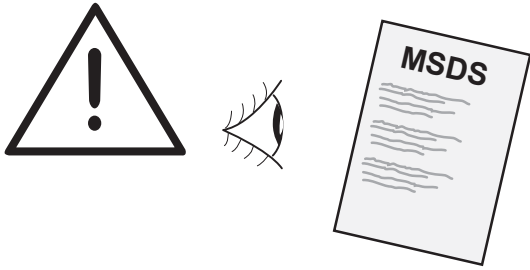

<http://your.msds.be>  
login: TMME  
password: MSDS

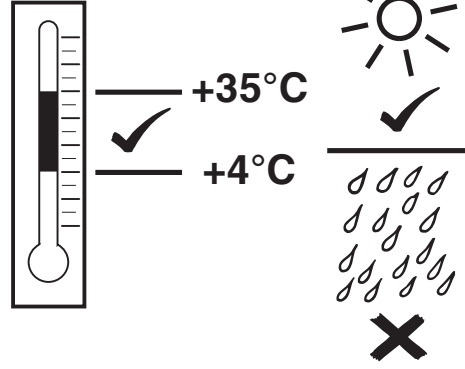

min.  
500 lx

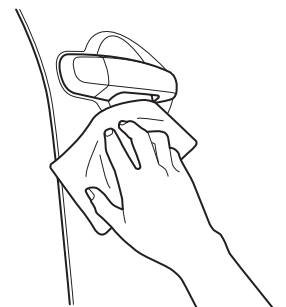
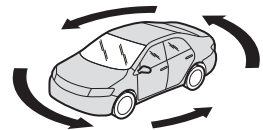
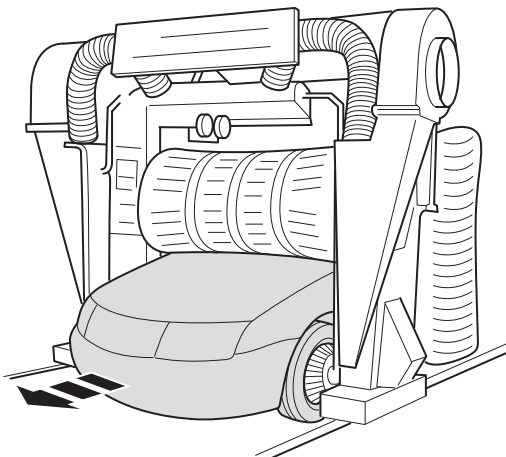
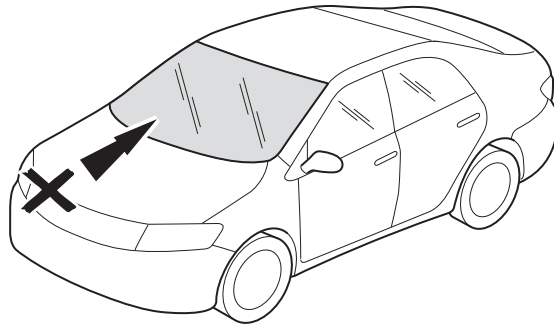
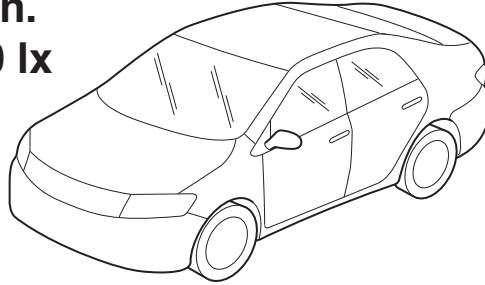
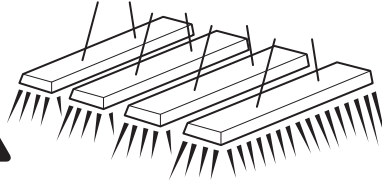

1

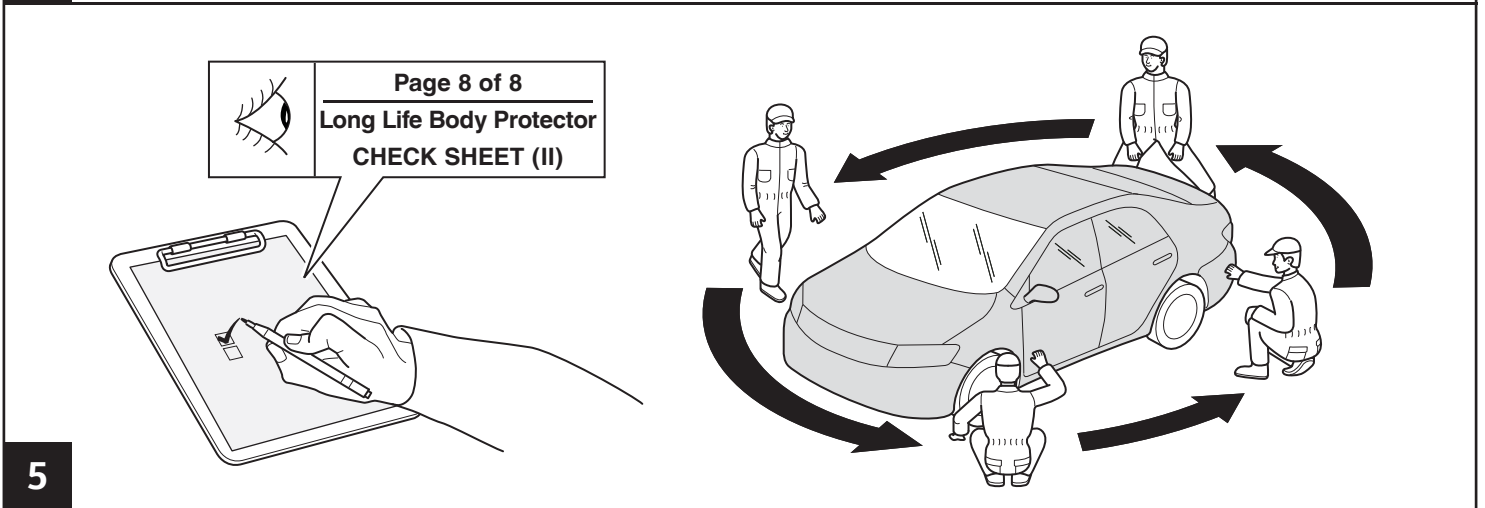
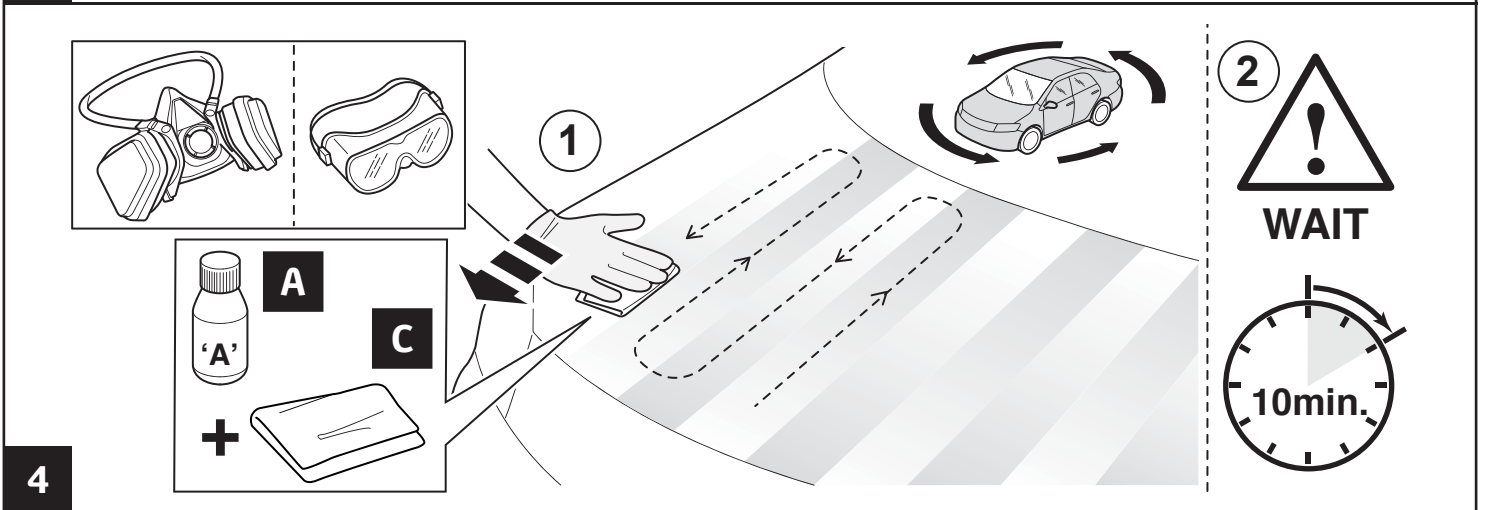
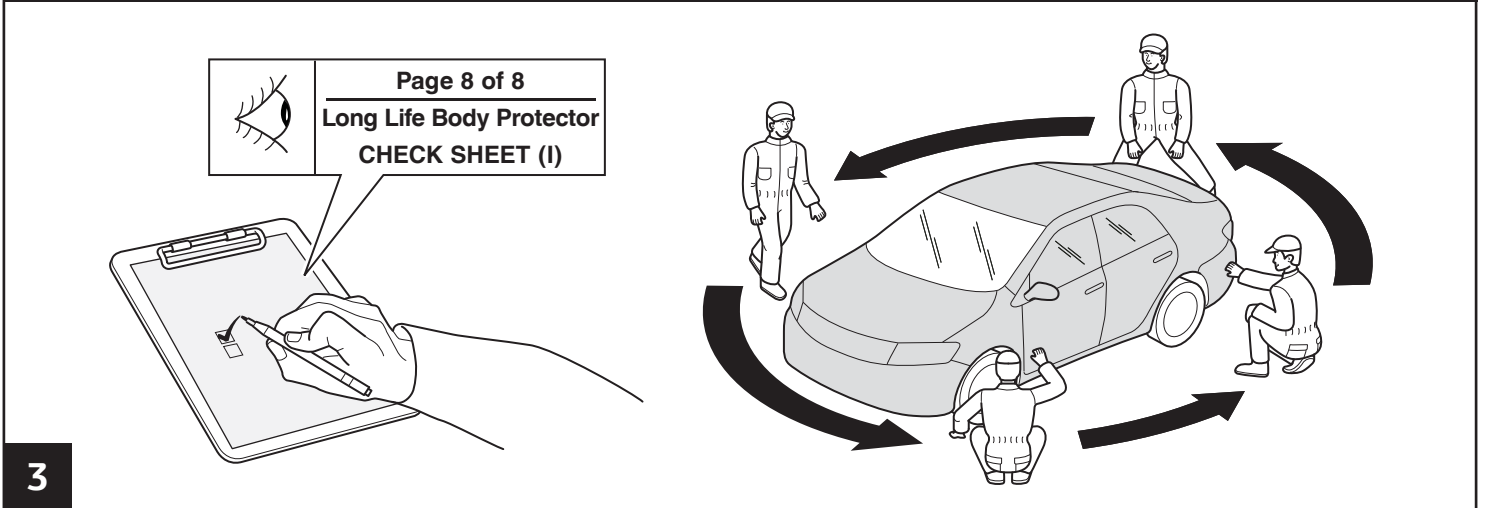
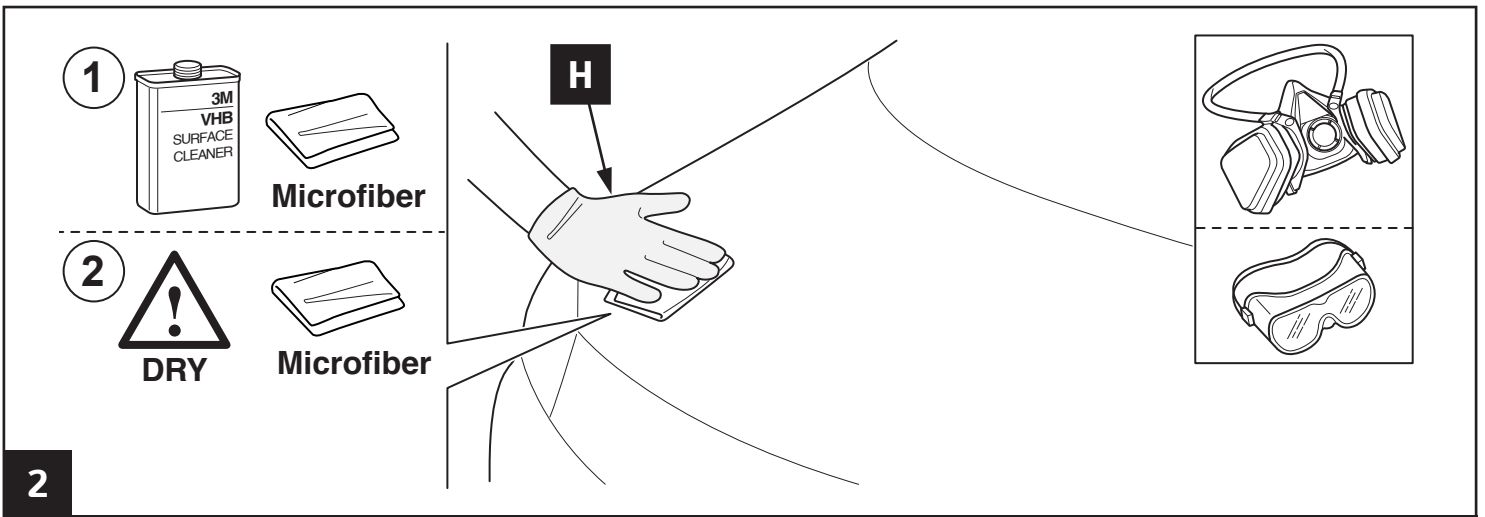

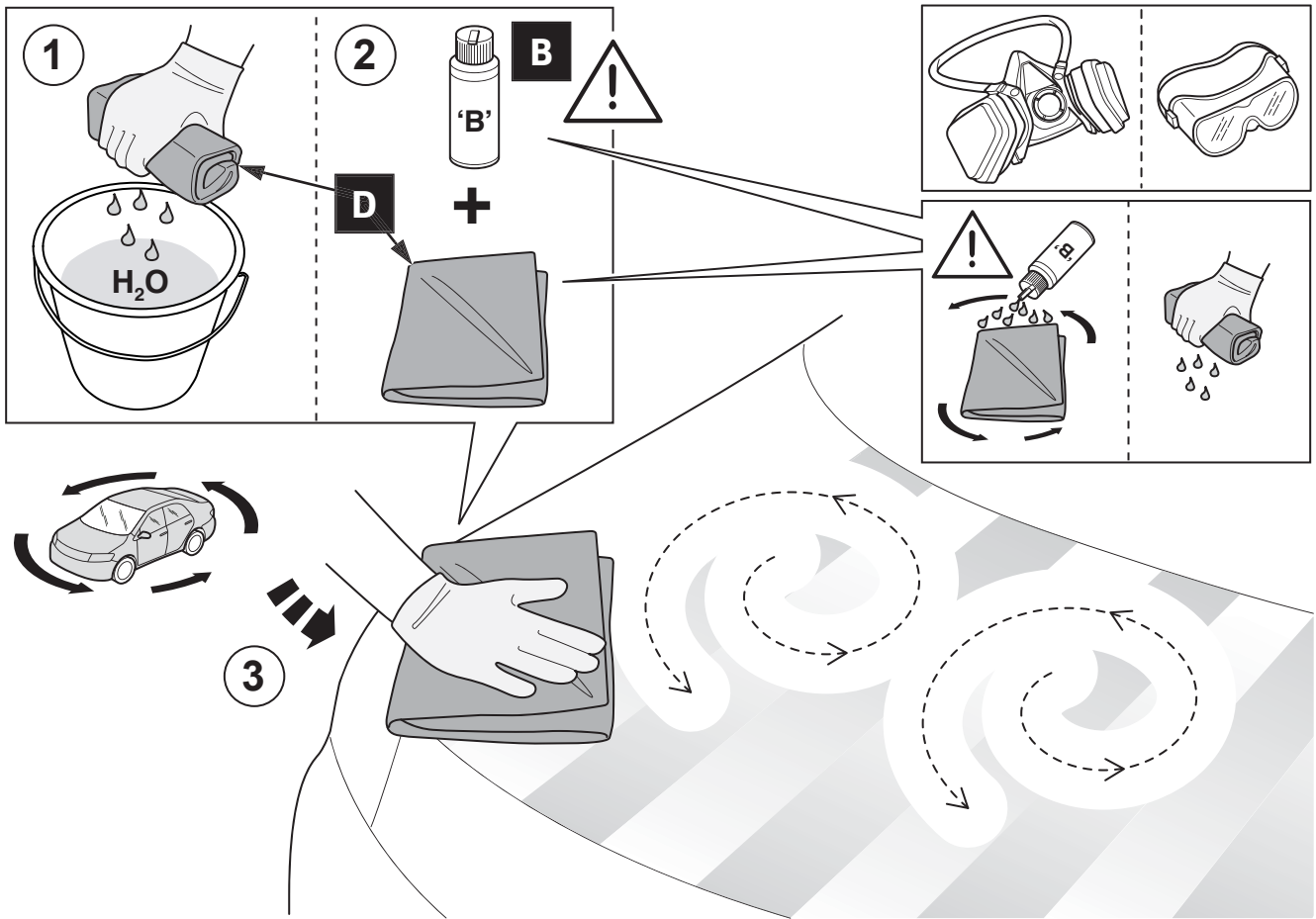

6

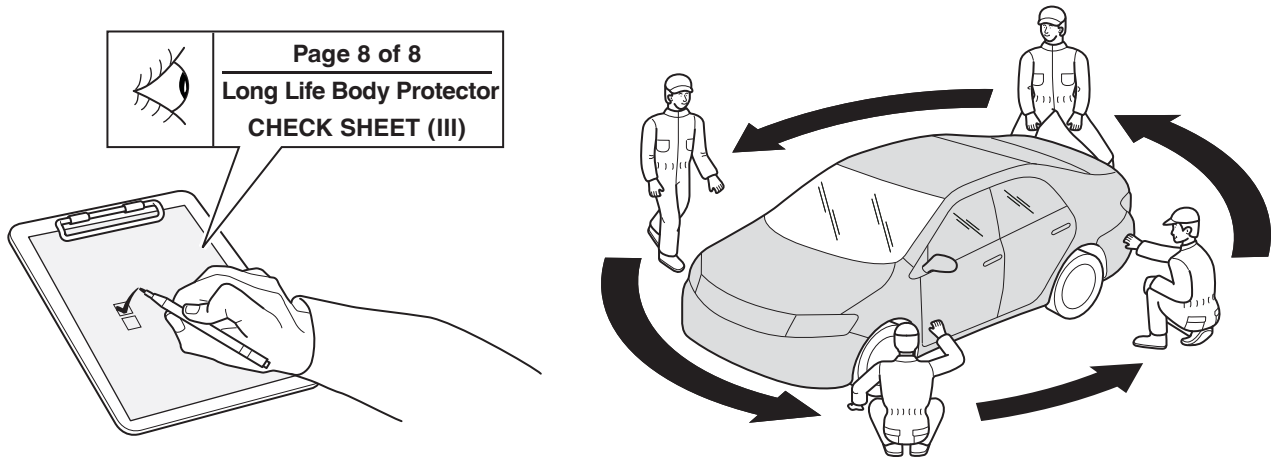

7

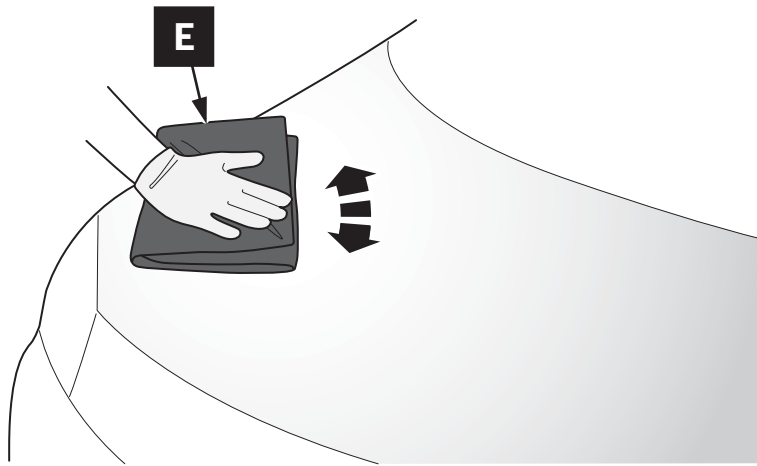

8

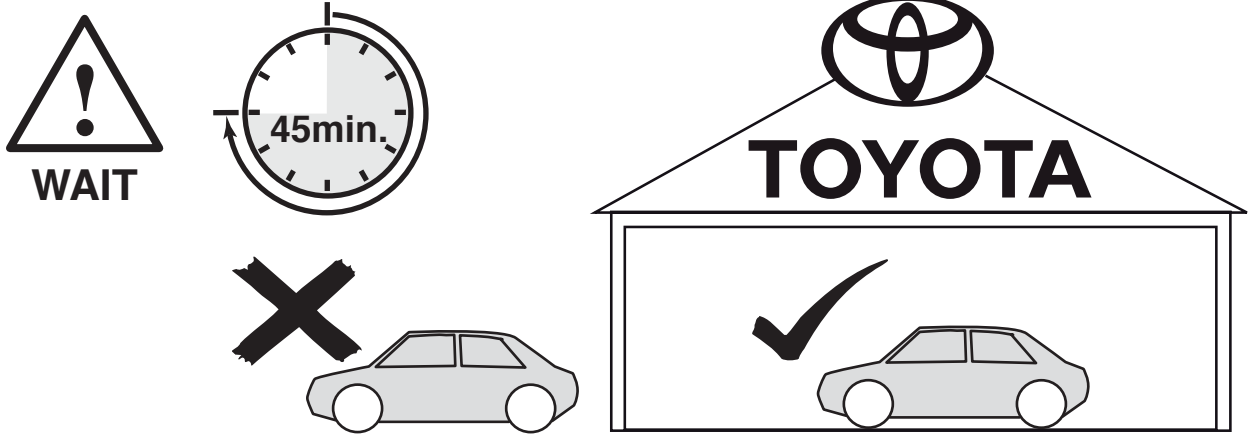

9

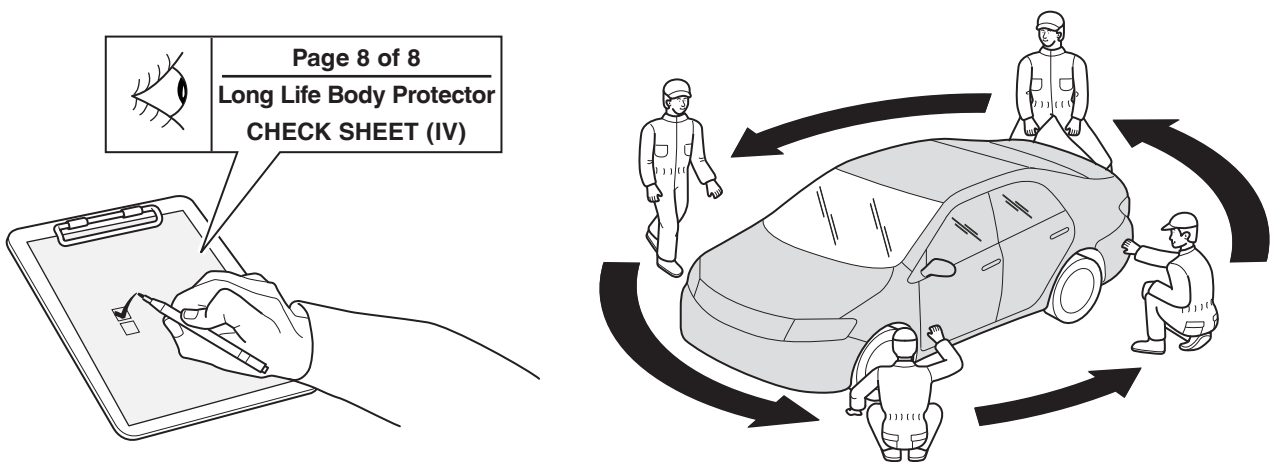

10

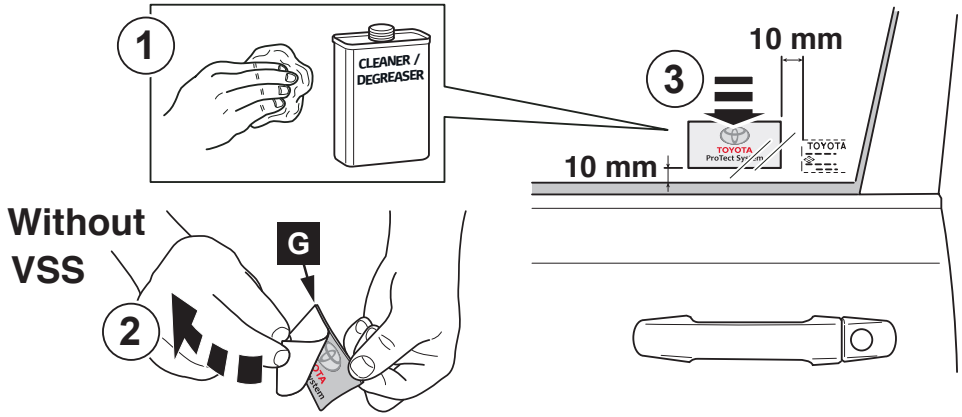
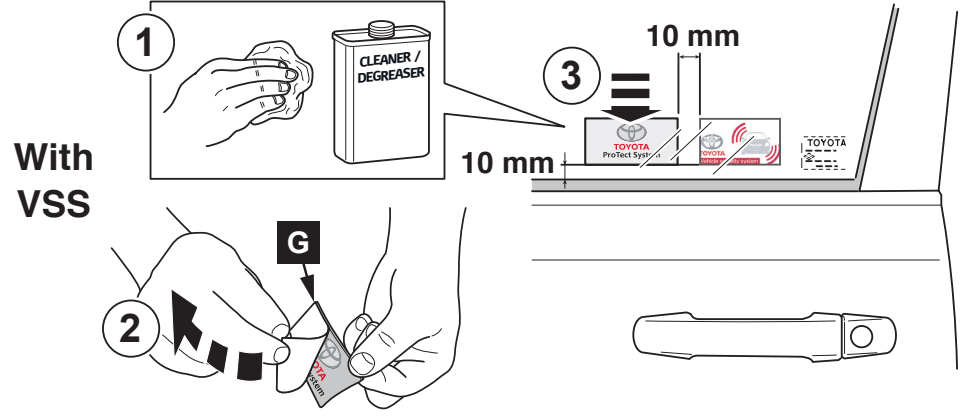
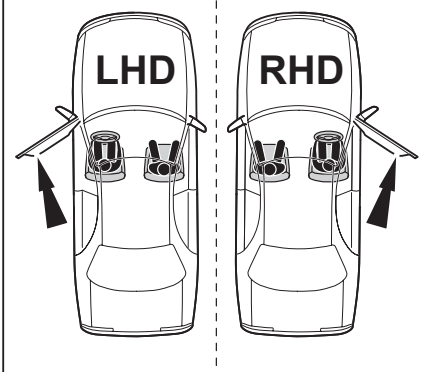
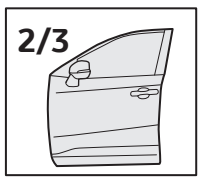
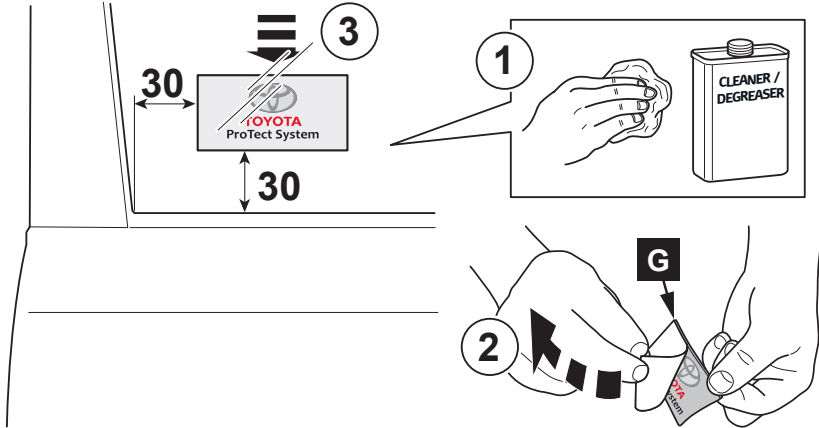
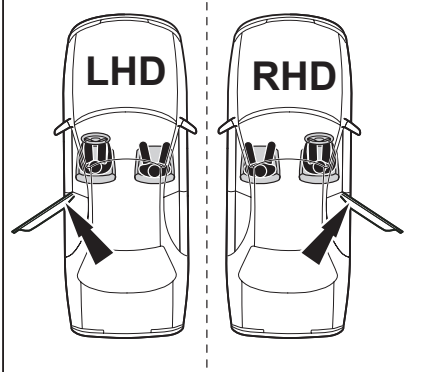
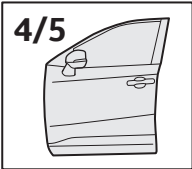

11

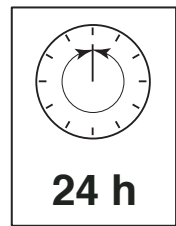
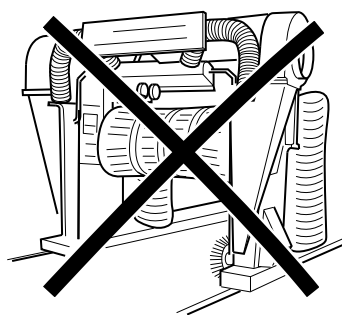

12



# Long Life Body Protector CHECK SHEET



Dealer Name \_\_\_\_\_  
 Technician \_\_\_\_\_  
 Date . . / . . / . . . .  
 VIN n°

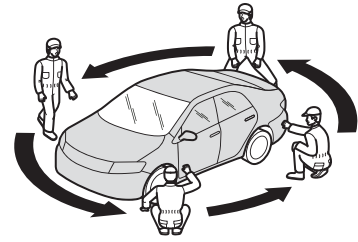

## I. After degrease

dry, no damage and clean

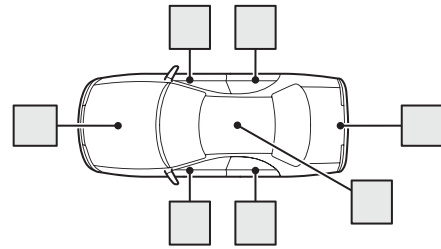

## II. After product 'A'

wipe traces on all areas

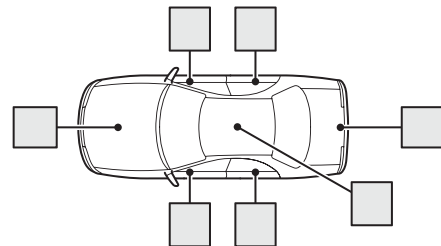
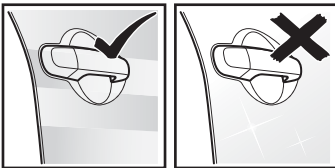

## III. After product 'B'

small drops on all areas

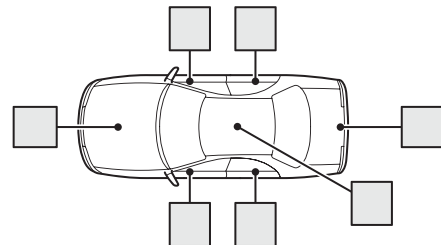
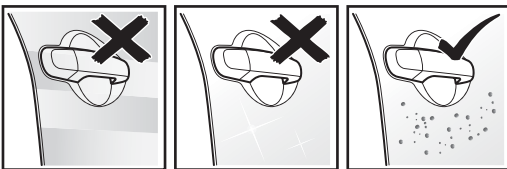

## VI. After wipe

smooth on all areas

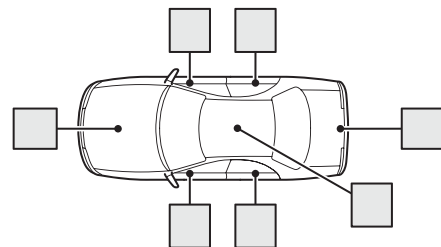

Signature

Stamp