



TOYOTA

ALWAYS A
BETTER WAY

RAV4 RAV4 Plug-in Hybrid

Side sills

Installation Instructions

Model year:	As from 2018/11 As from 2020/06 (Plug-in Hybrid)
Vehicle code:	*XA*5**-AN**BW
Part number:	PW156-42000-01 Side sills (Hexavalent Chromed) PW156-42000-24 Side sills (Trivalent Chromed)

Manual reference number: AIM 004 248-3

Revision record

Rev. No.	Date	Page	Picture	Update	New	Deleted steps
1	26.12.2018	3, 4, 13	Tools, 2, CS		Nm Value	
Rev. No.	Date	Page	Step	Remarks		
△ 2	22.07.2019	1		Katashiki for Russia added		
△ 3	06.02.2020	1, 13		Model year updated.		

PW156-42000-**

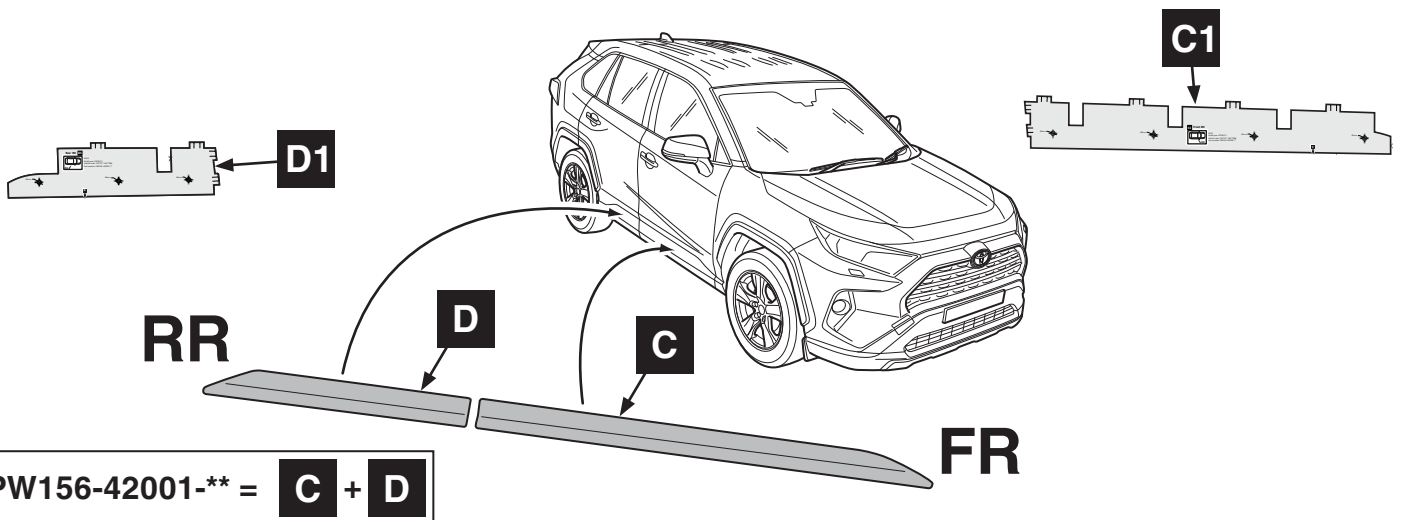
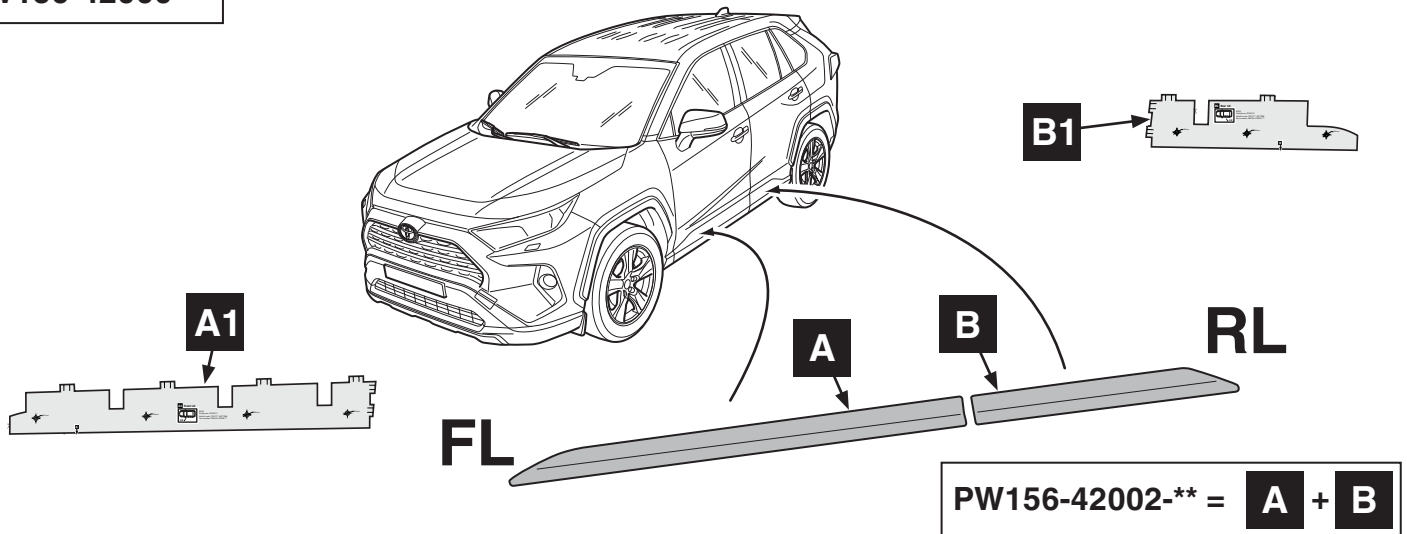

PZ415-00000-00

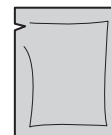





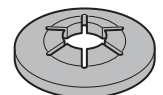





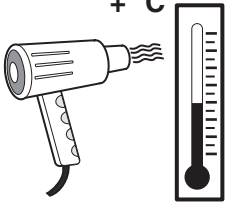

E

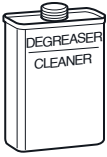
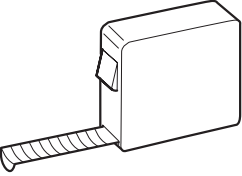
Adhesion promoter 2x

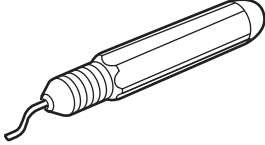
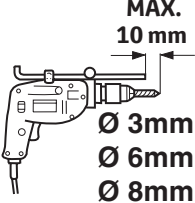
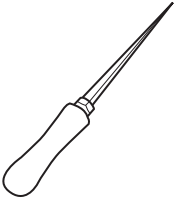

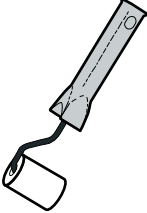
F

14x

 ? °C	 + °C	 10mm		  AIM 003 516-*
	 10mm		 MAX. 10 mm Ø 3mm Ø 6mm Ø 8mm	
				

INFO

Material Safety Data Sheet



Technical Data Sheet

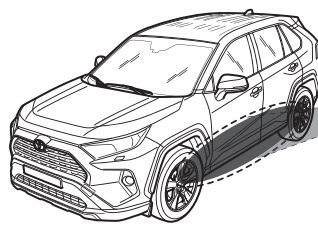

20°C - 40°C

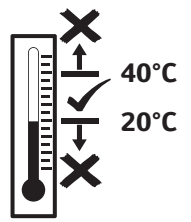
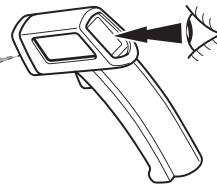

20°C - 40°C

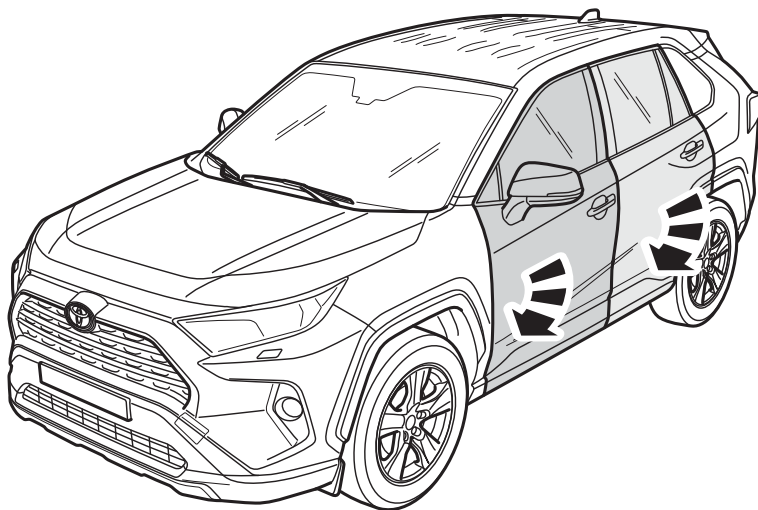
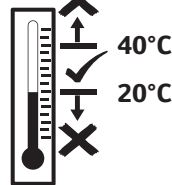
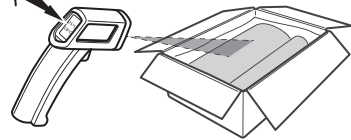

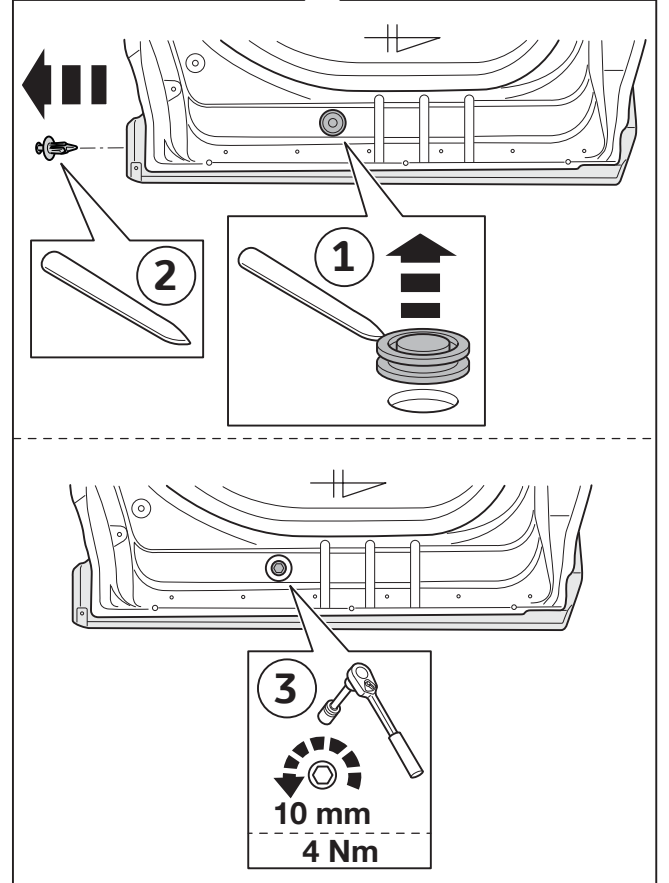
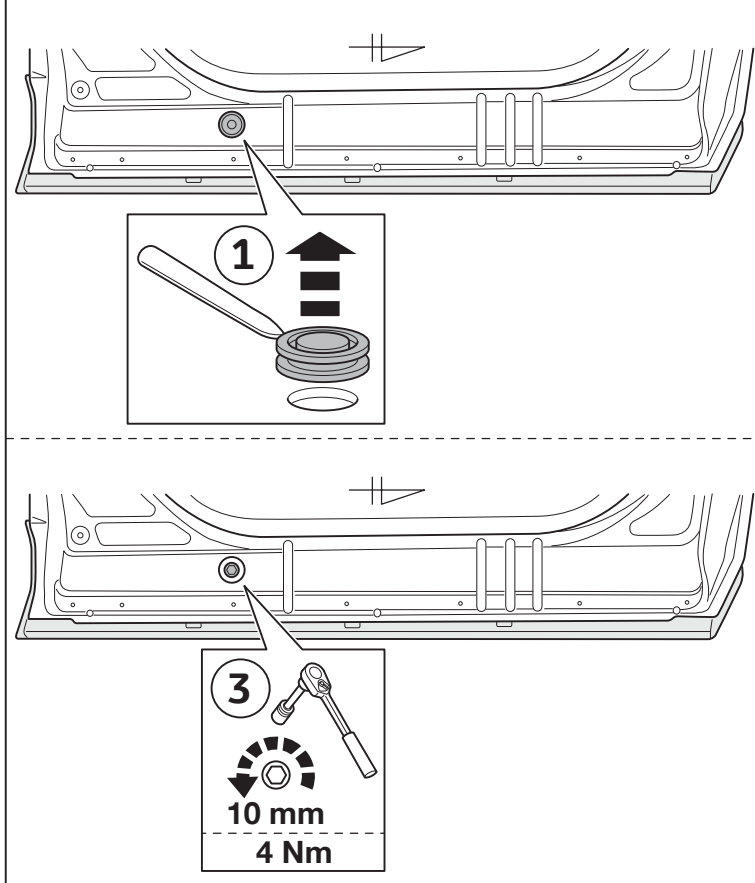
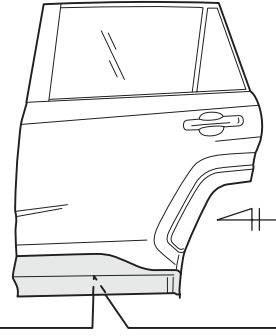
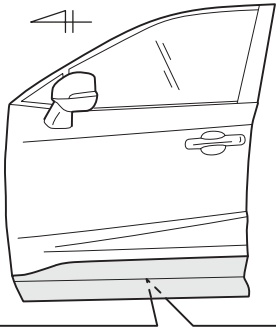

2

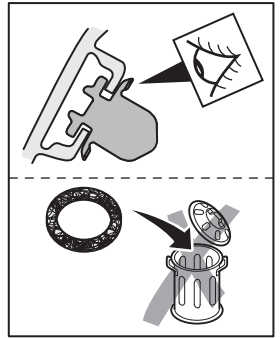
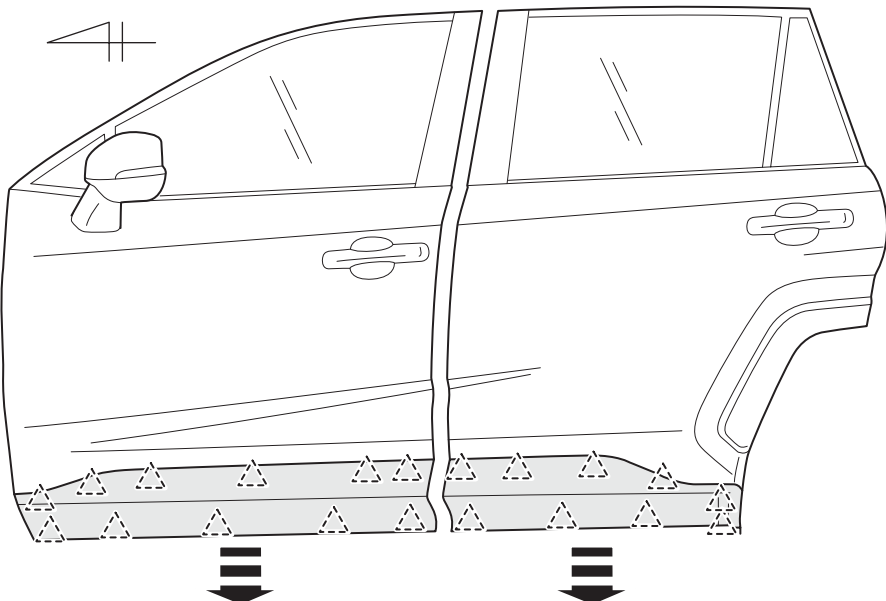
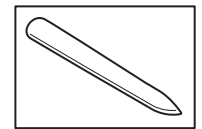
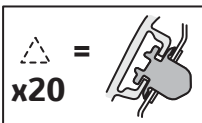

3

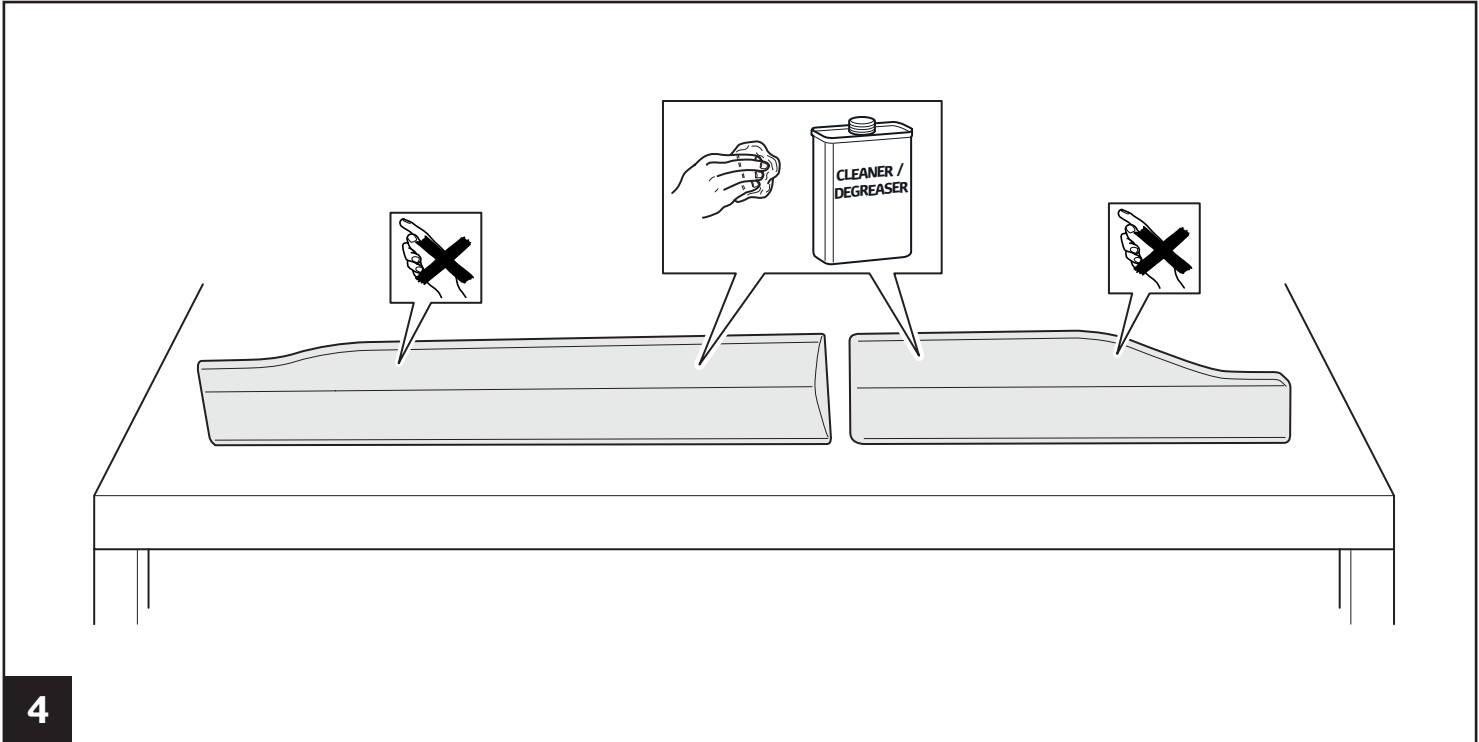



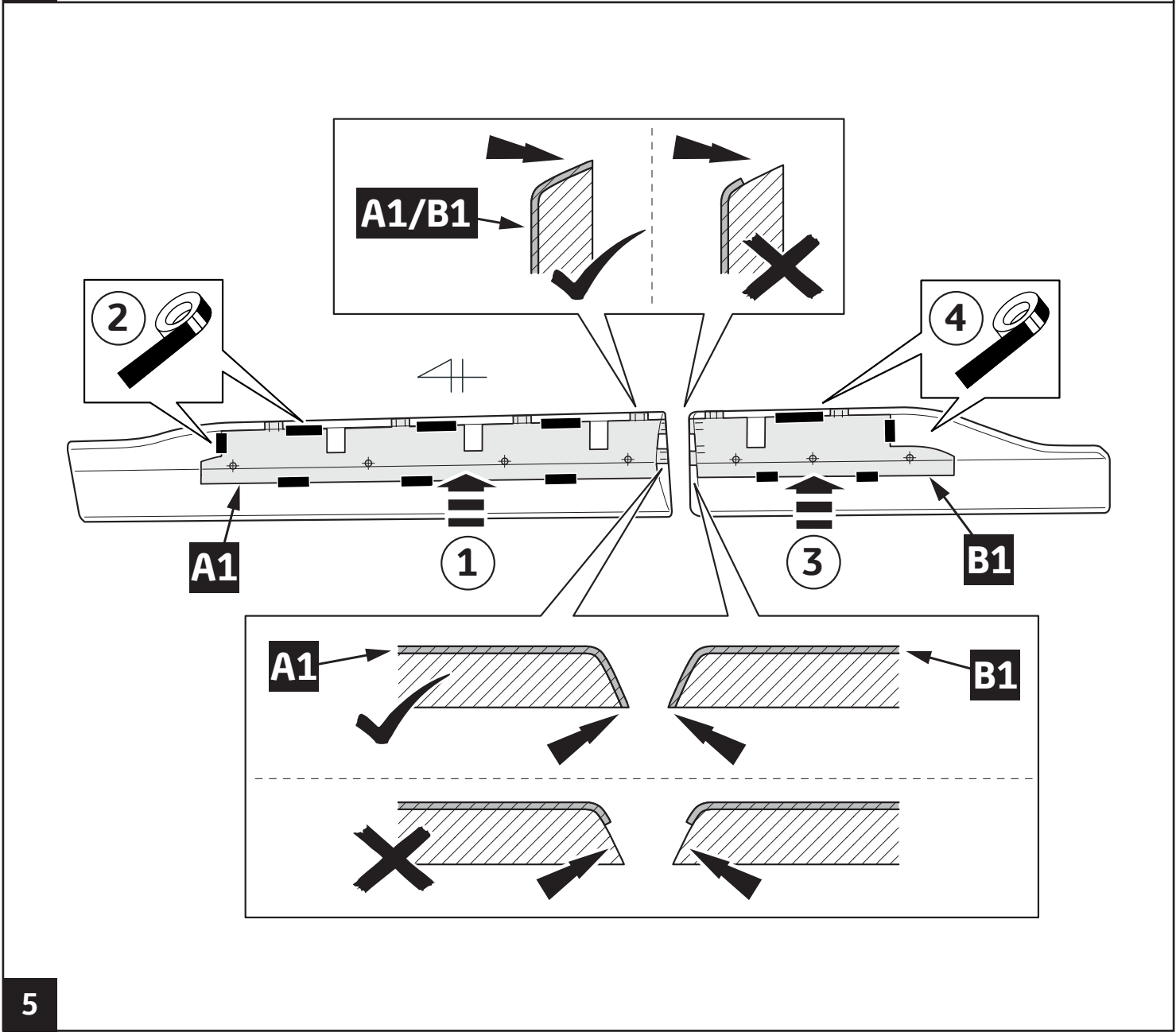

4

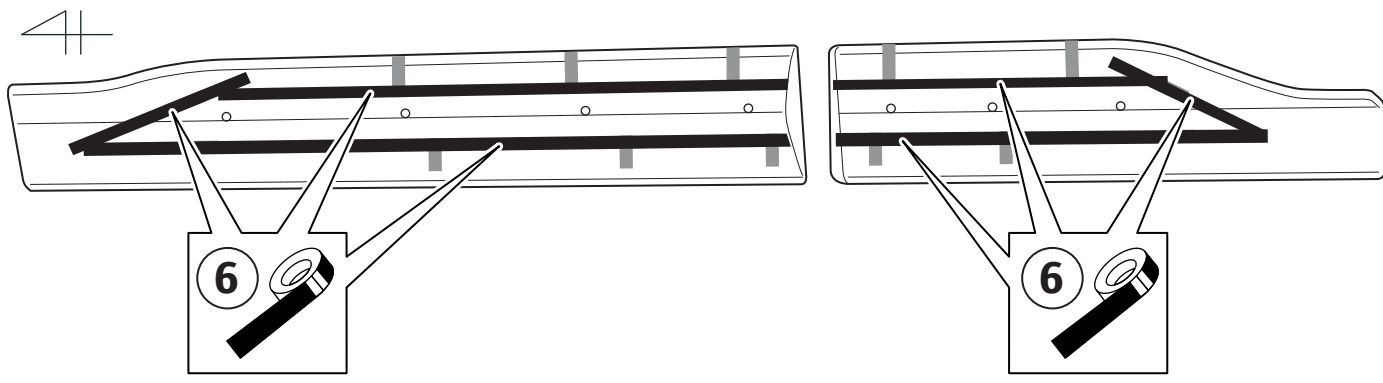
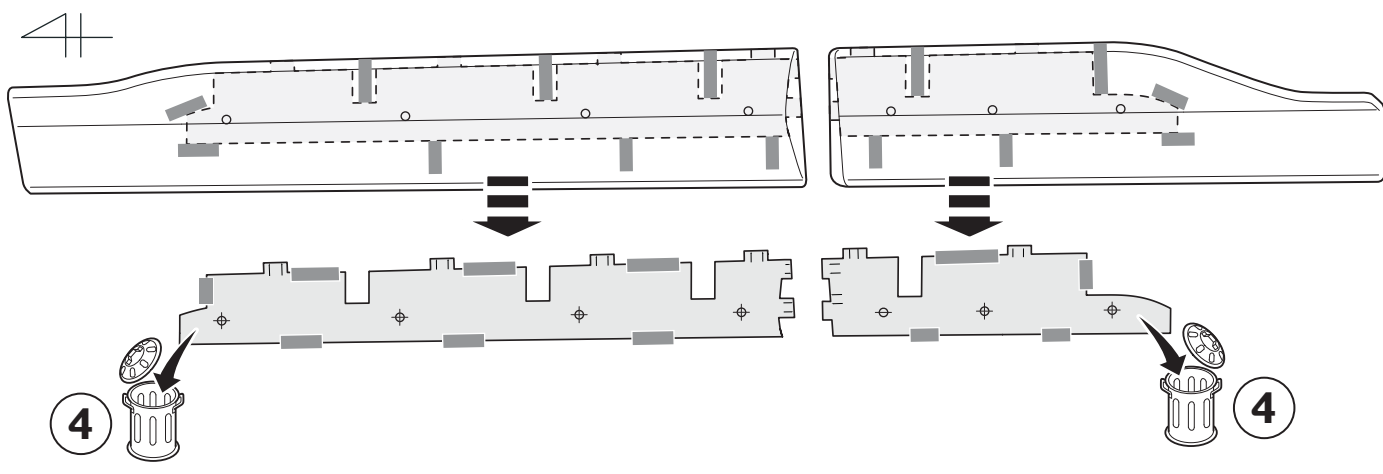
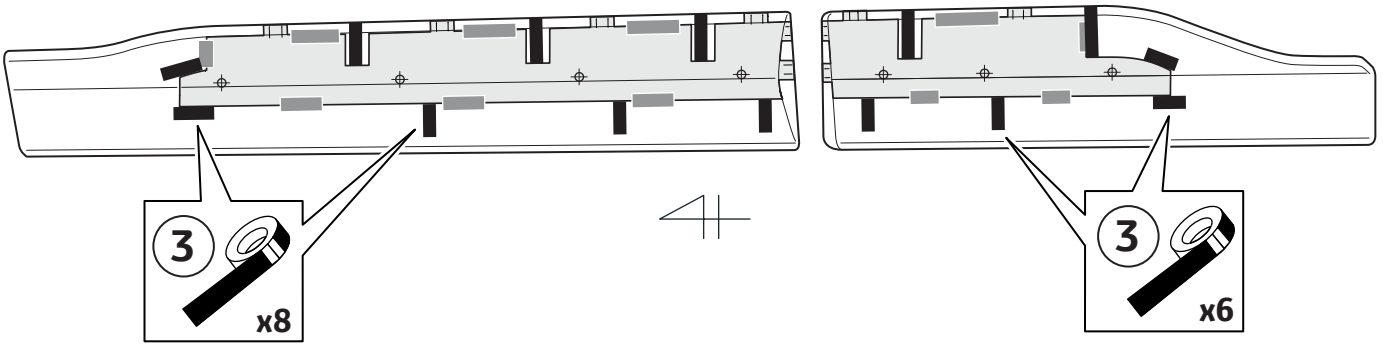
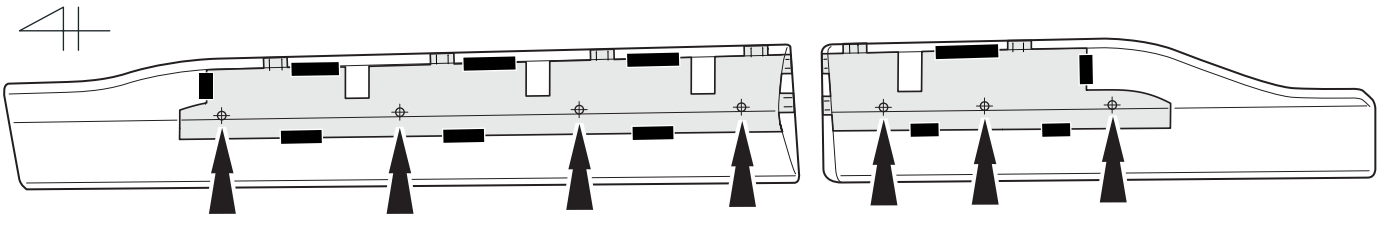
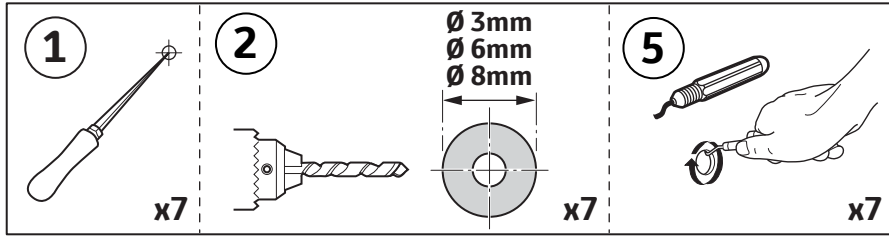
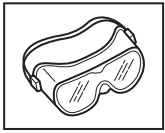

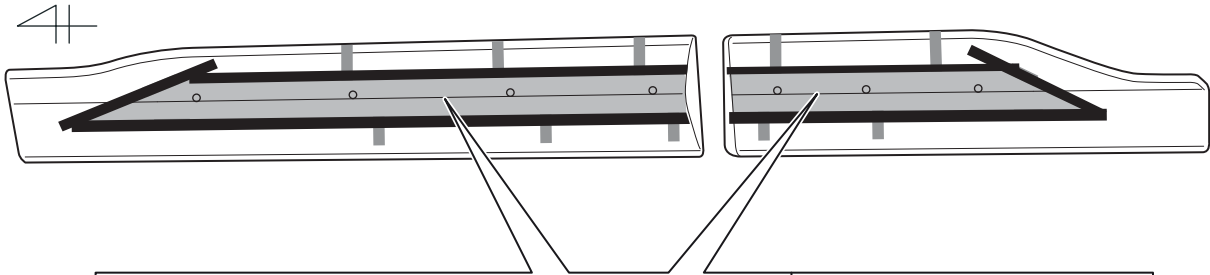
5

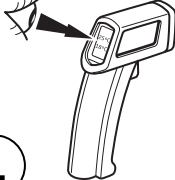
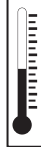
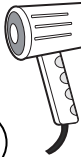
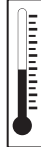
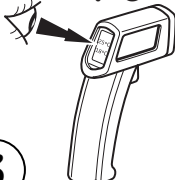
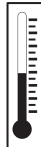





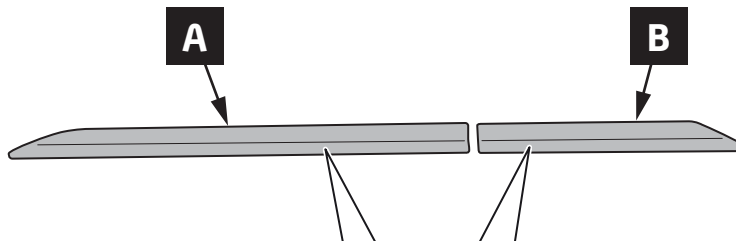

<p>①  ? °C</p> 	<p>< 20°C → ②</p> <p>20°C - 40°C → 8</p>	<p>②  + °C</p> 
<p>③  ? °C</p> 	<p>20°C - 40°C → 8</p>	<p>INFO</p>  <p>7 → 19</p>  

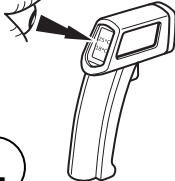
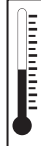
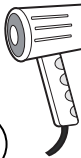
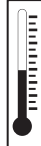
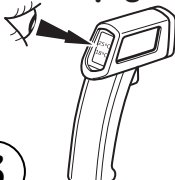
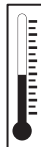
7



<p>①  ? °C</p> 	<p>< 20°C → ②</p> <p>20°C - 40°C → 9</p>	<p>②  + °C</p> 
<p>③  ? °C</p> 	<p>20°C - 40°C → 9</p>	<p>INFO</p>  <p>8 → 19</p>  

8

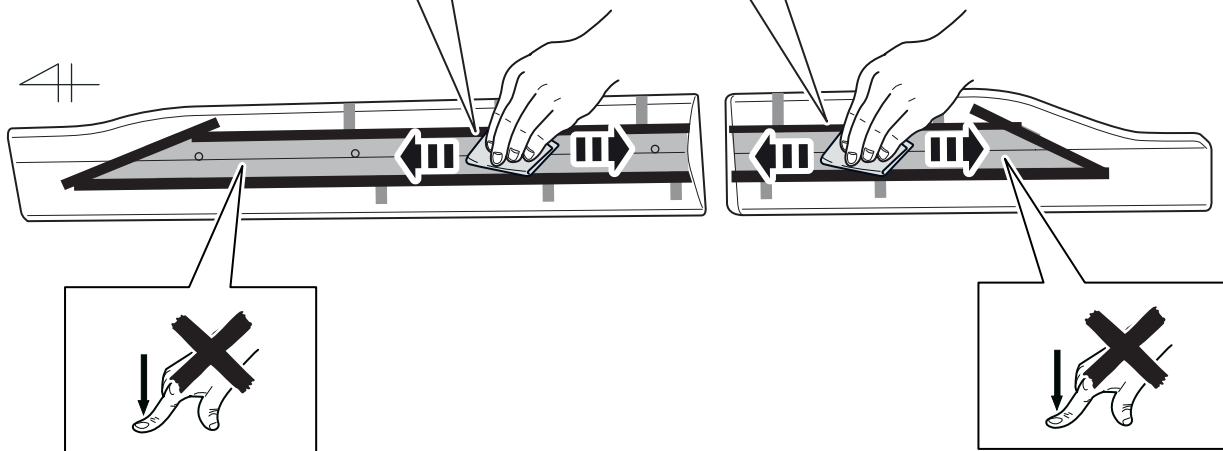
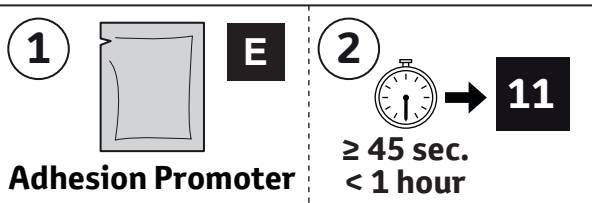

9

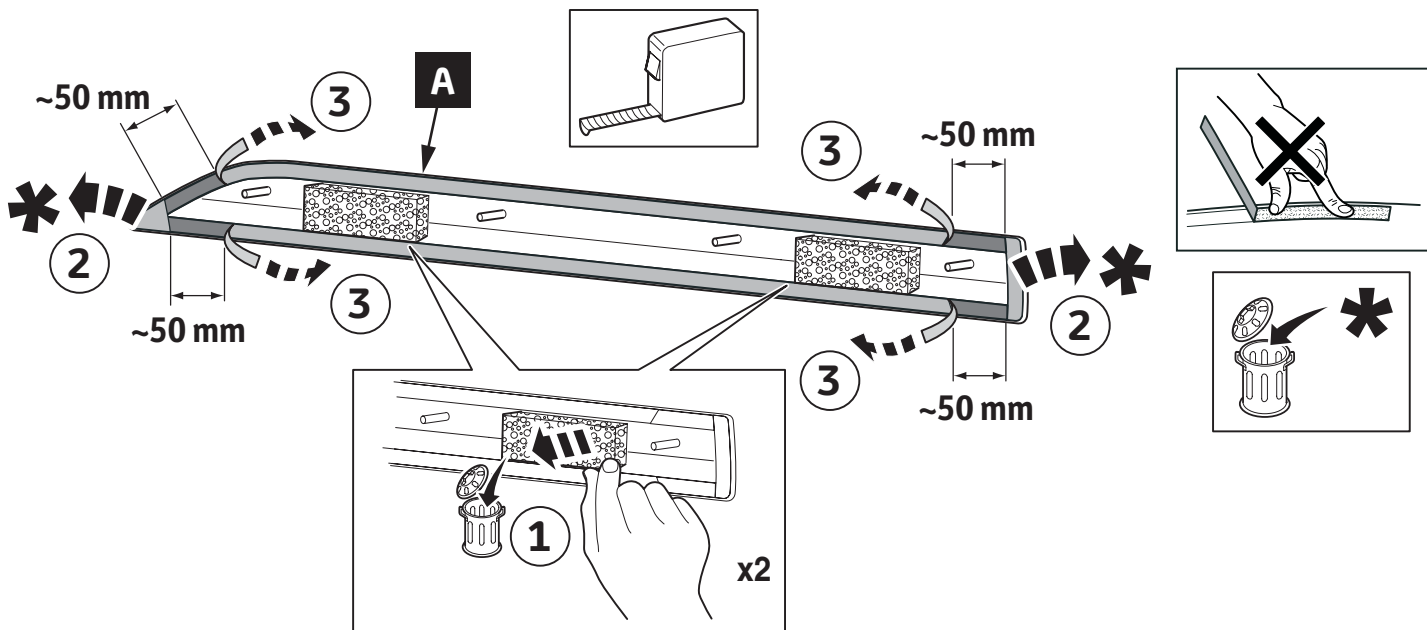

10

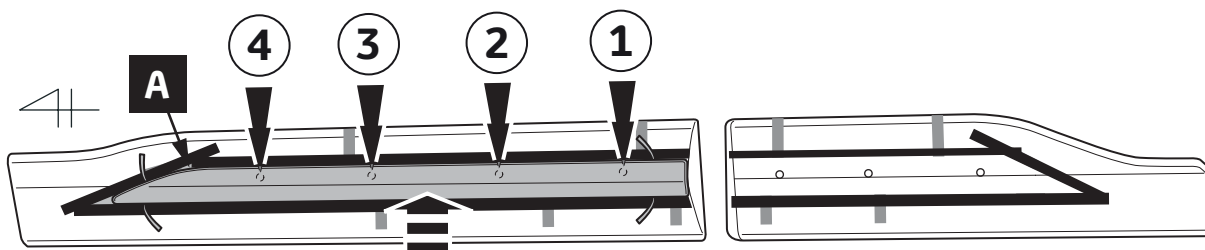

11

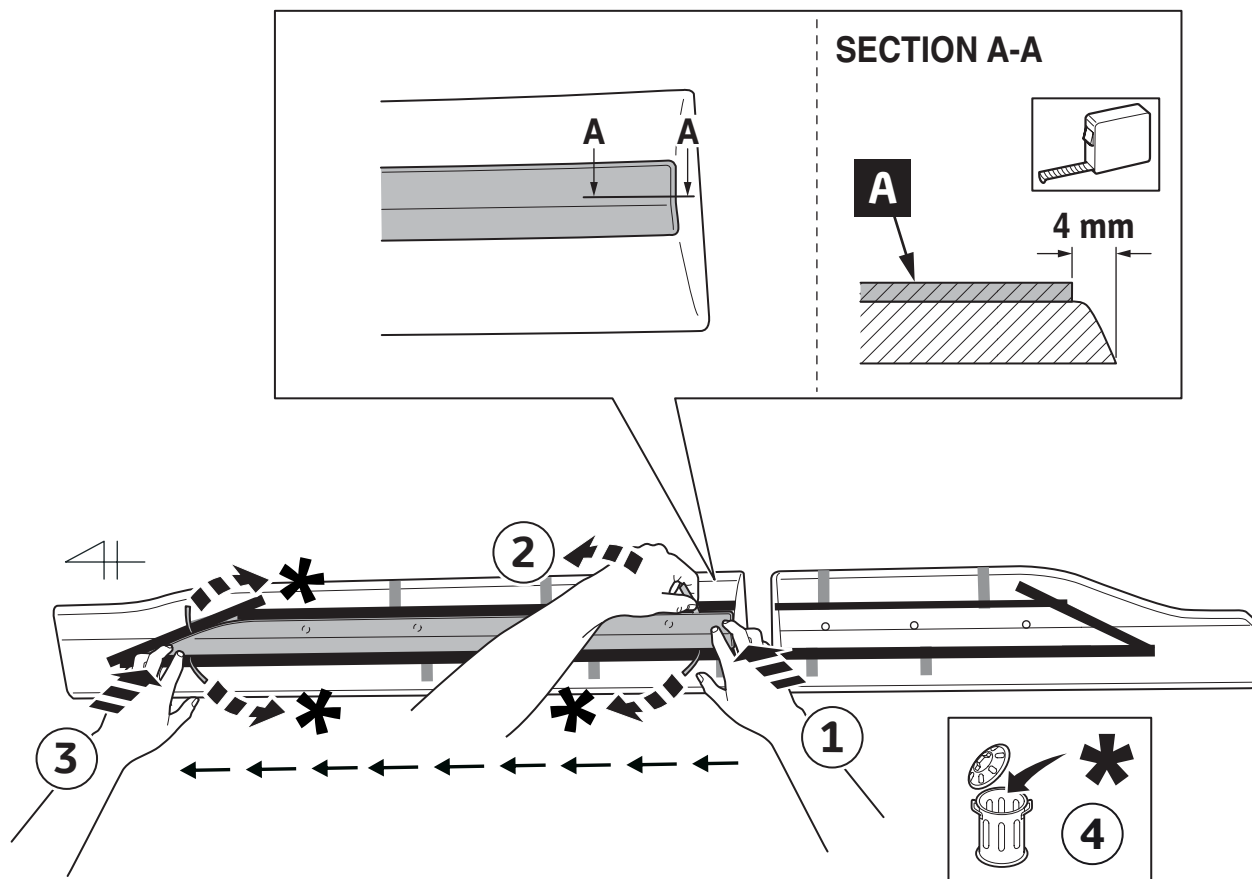

12

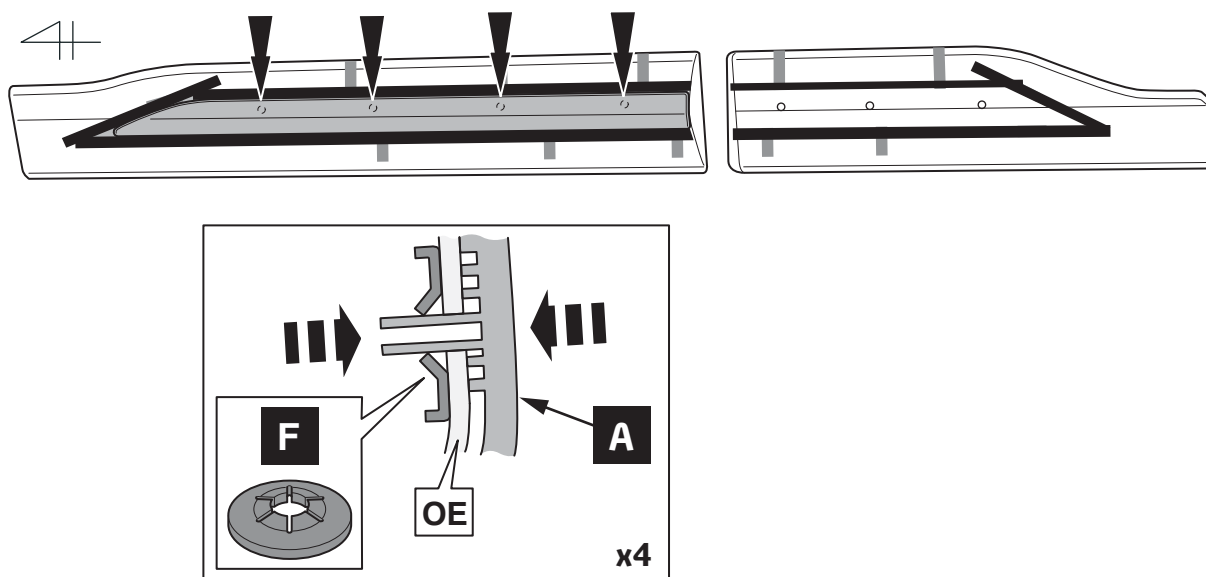

13

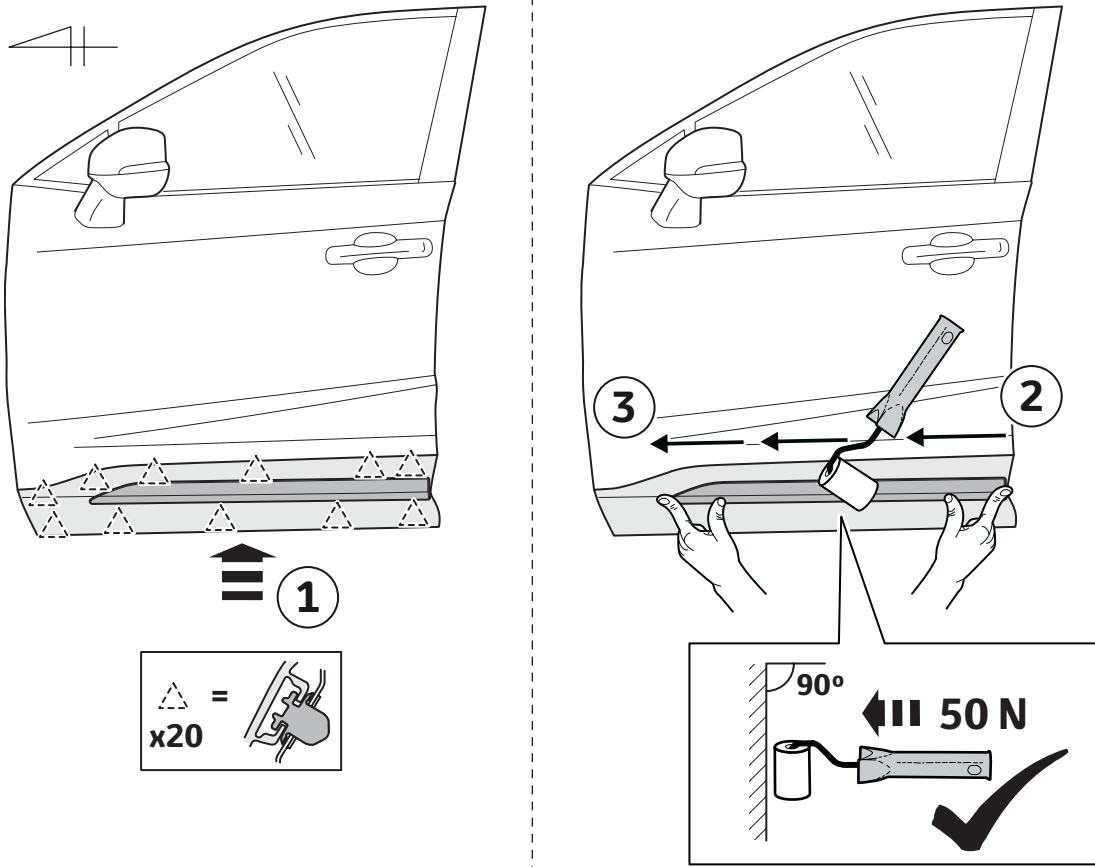

14

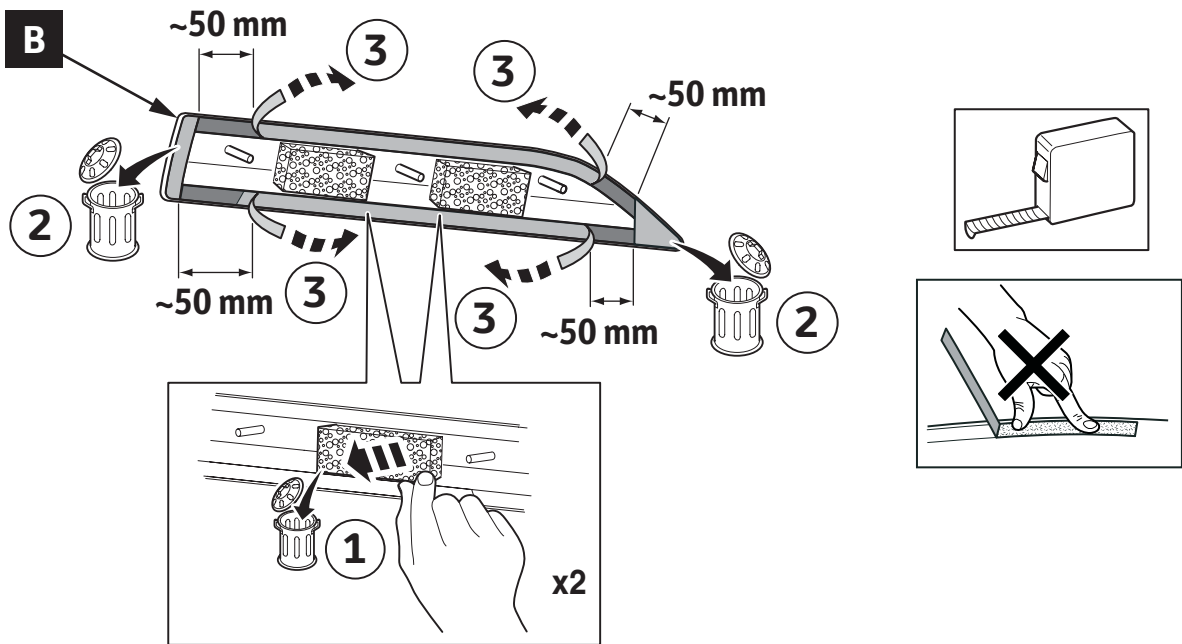

15

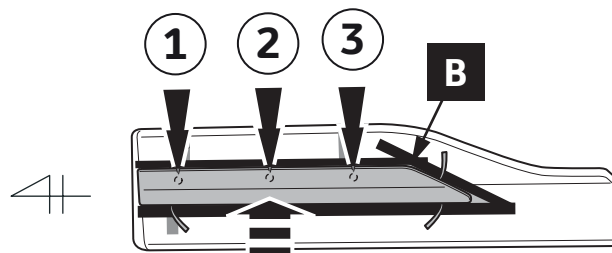

16

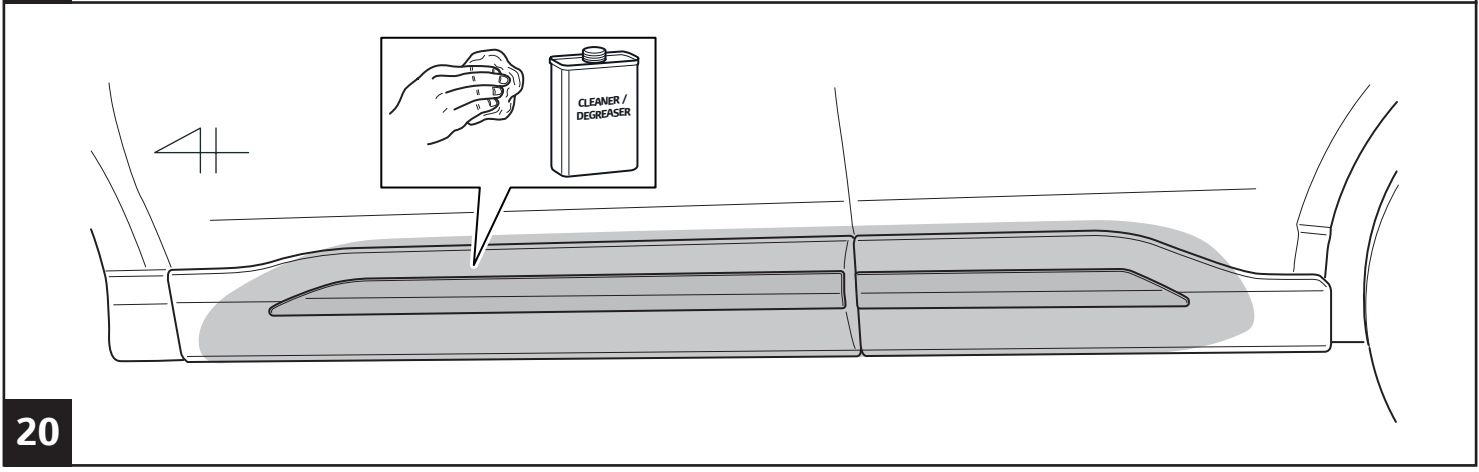
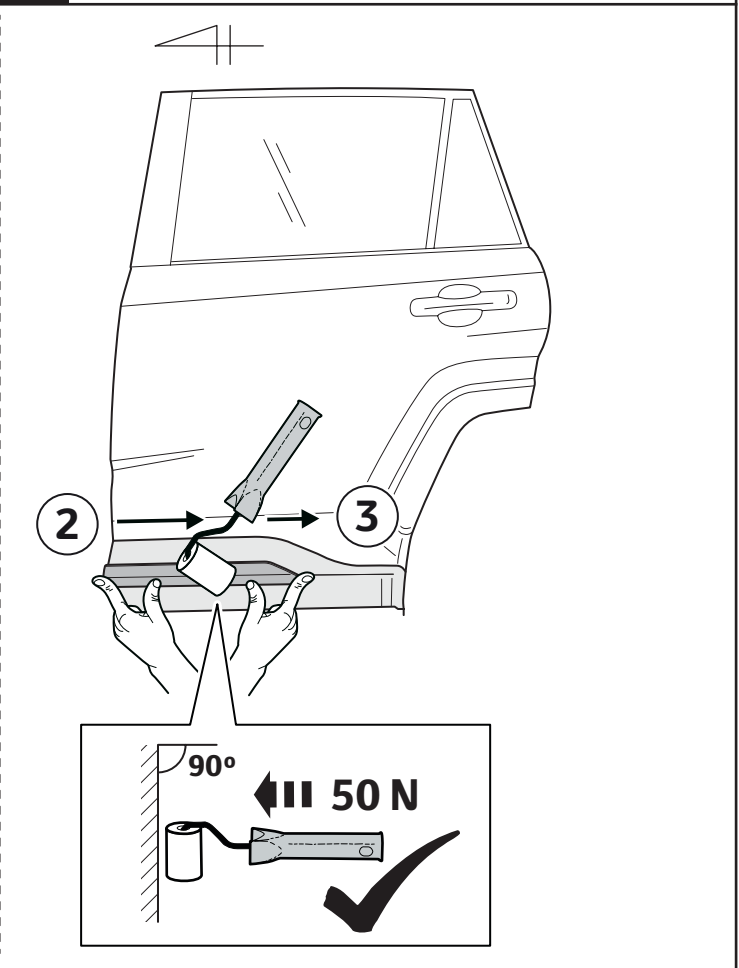
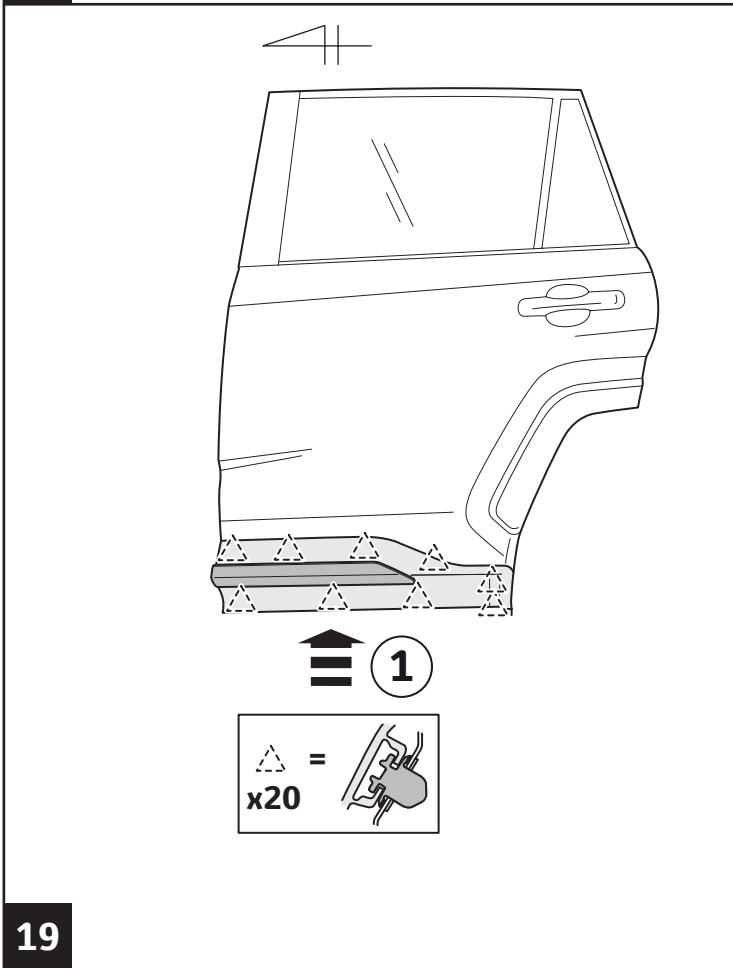
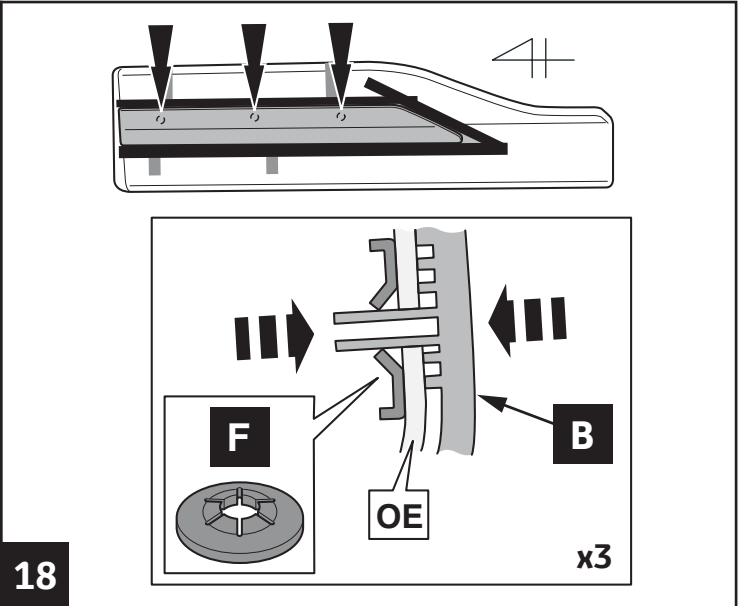
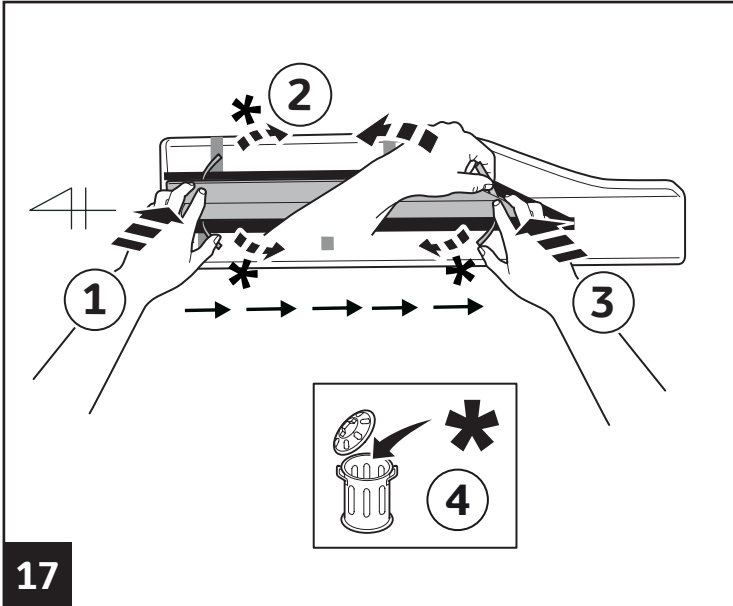

RHS = LHS

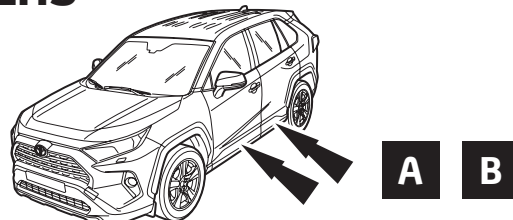
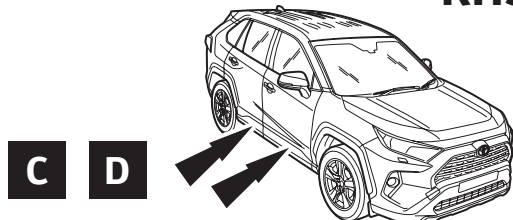

21

INFO

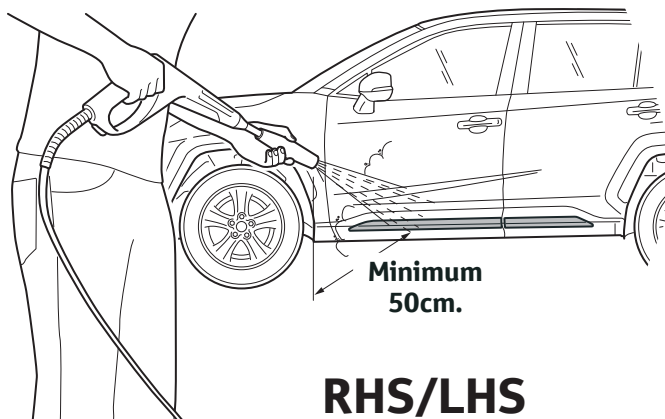
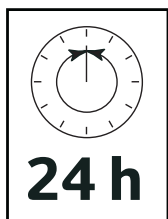
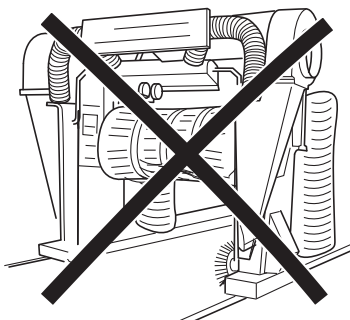
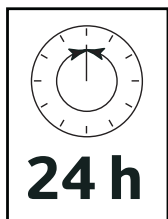
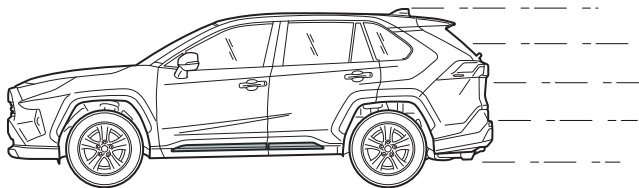
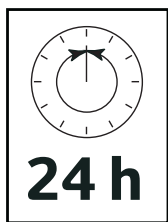



TOYOTA

CHECK SHEET

Page 1 of 1

Model/Year **RAV4 As from 2018/11**
RAV4 Plug-in Hybrid As from 2020/06 Side sills

VIN n°

ALWAYS A BETTER WAY

DURING INSTALLATION

1

P/N = OK

AFTER INSTALLATION

1

(4x)

4 Nm

Serial Number

2

LHS

RHS

3

4

= OK

Installation Date:
. . . / . . . /

Technician Name & Signature:

Stamp:

