



TOYOTA

ALWAYS A
BETTER WAY

Land Cruiser

Rear lamp chrome bezel

Installation Instructions

Model year: 2017/08
Vehicle code: **J150*-G**E**
Part number: 08176-60810

Manual reference number: AIM 004 138-0

Revision record

Rev. No.	Date	Page	Picture	Update	New	Deleted steps

08176-60810

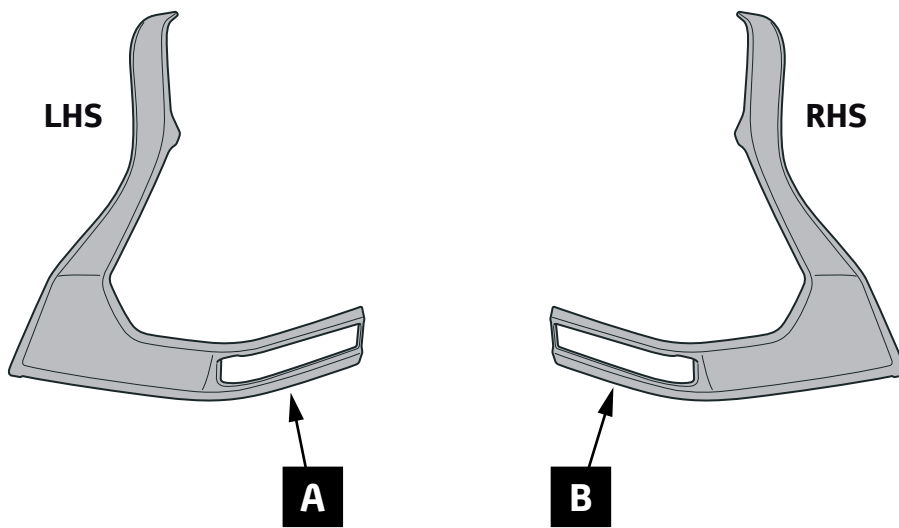

1x

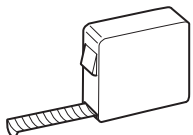



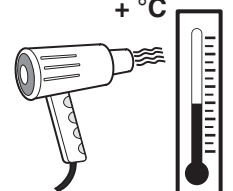
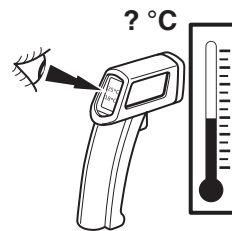
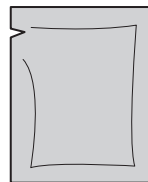

**(1x) PZ415-00000-00
3M Adhesion Promoter**

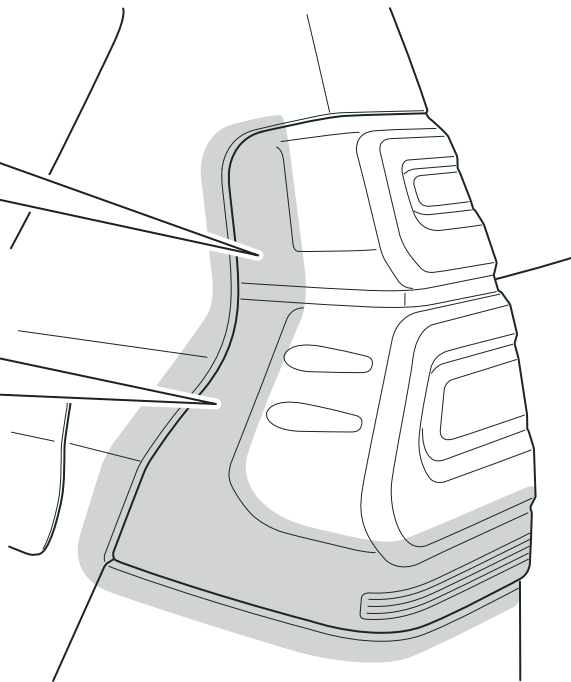
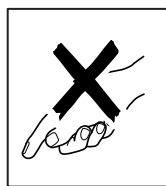
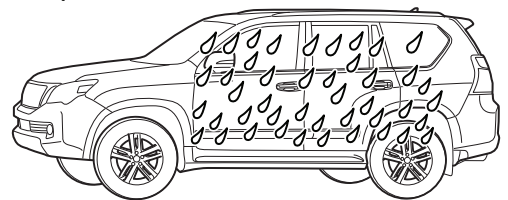
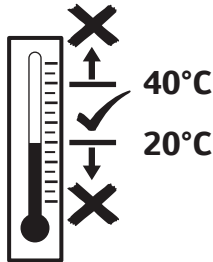
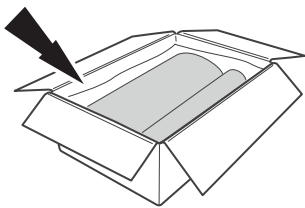
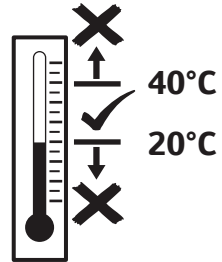
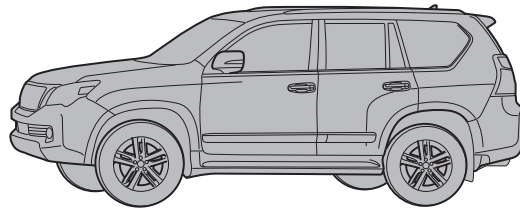

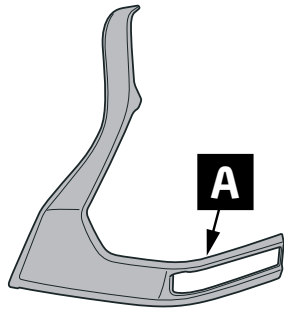
INFO

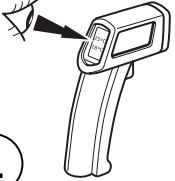
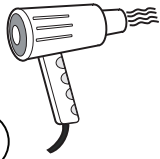
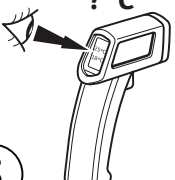





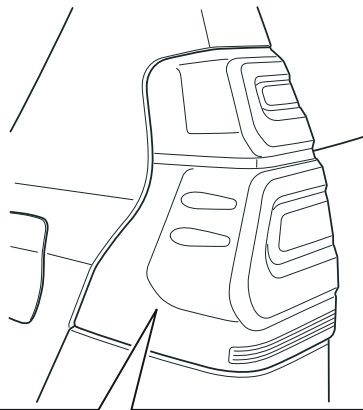

<p>①  ?°C</p>	<p>< 20°C → ②</p> <p>20°C < 40°C → ③</p>	<p>②  +°C</p>
<p>③  ?°C</p>	<p>20°C < 40°C → ③</p>	<p>INFO</p> <p> ② → ⑥</p> <p> ✓</p> <p> ✗</p>

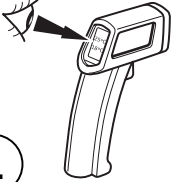
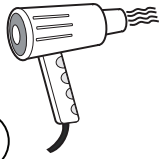
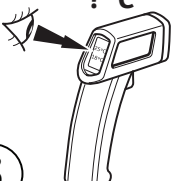

2

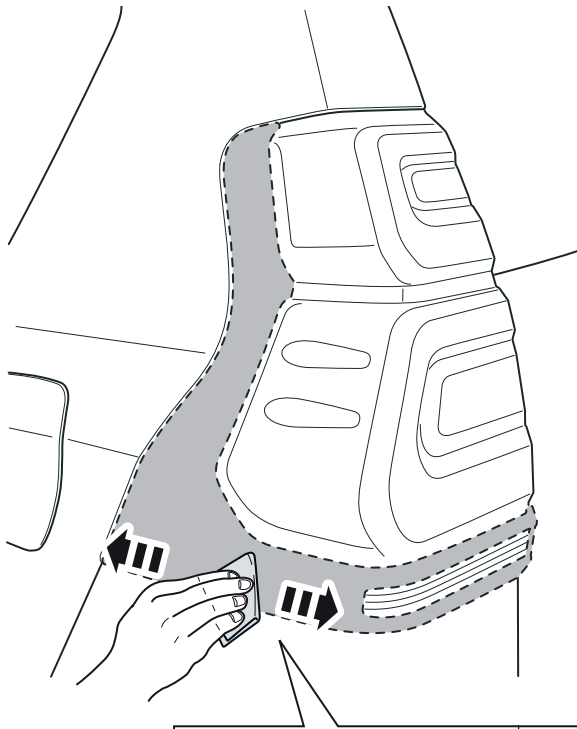

<p>①  ?°C</p>	<p>< 20°C → ②</p> <p>20°C < 40°C → ④</p>	<p>②  +°C</p>
<p>③  ?°C</p>	<p>20°C < 40°C → ④</p>	<p>INFO</p> <p> ③ → ⑥</p> <p> ✓</p> <p> ✗</p>

3

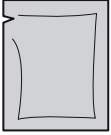

1  Adhesion Promoter	2  ≥ 45 sec.	6
---	--	----------

4

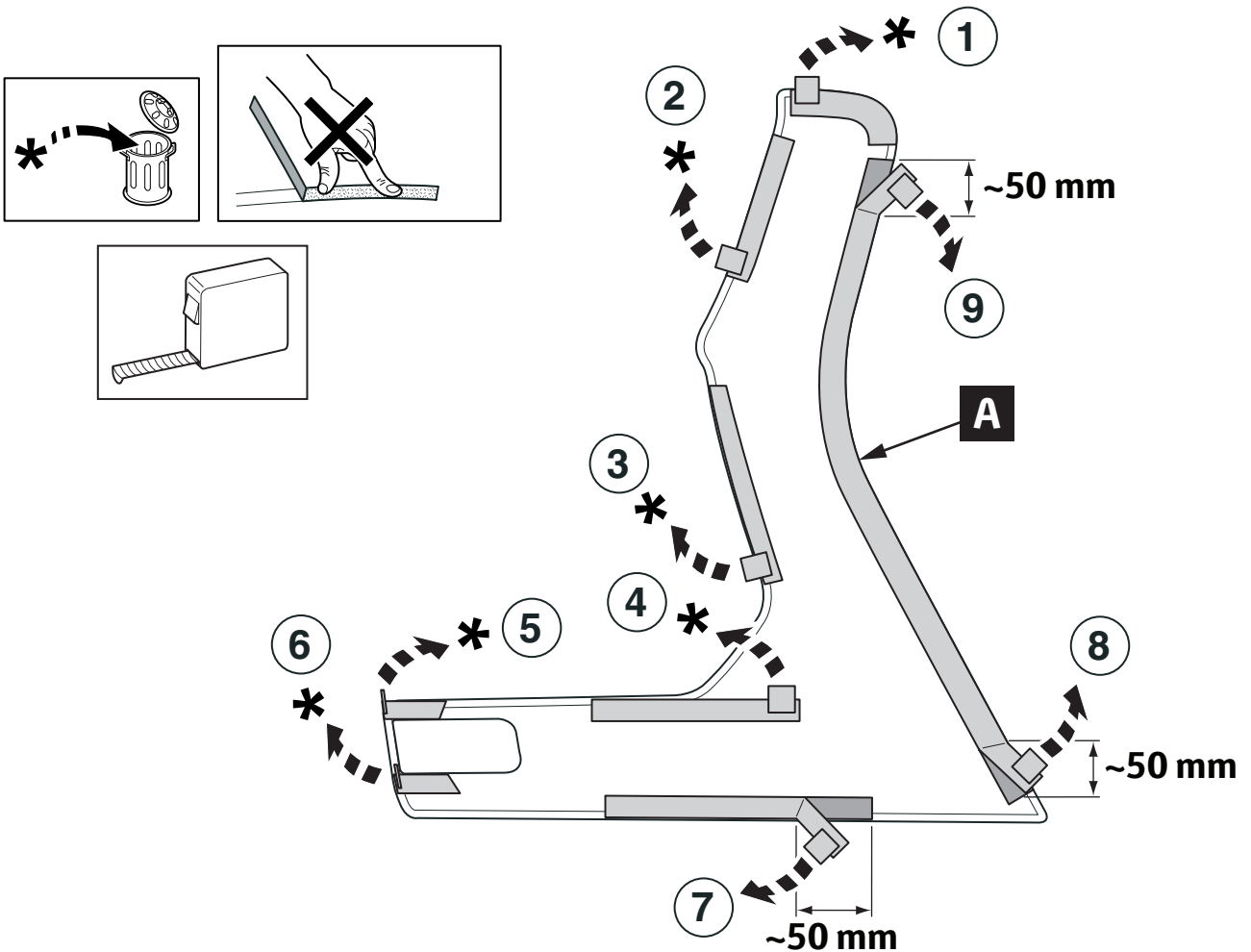

5

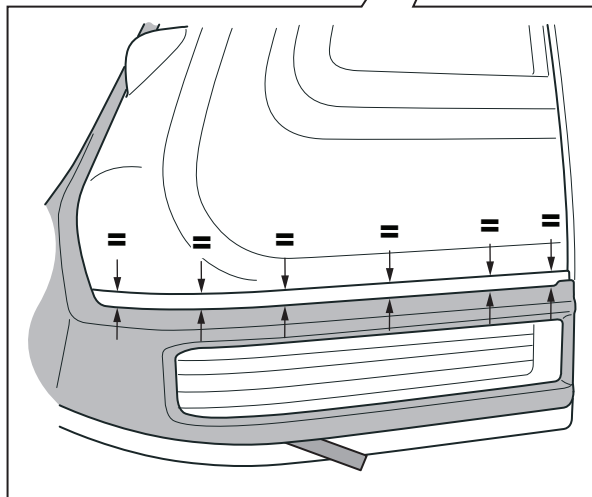
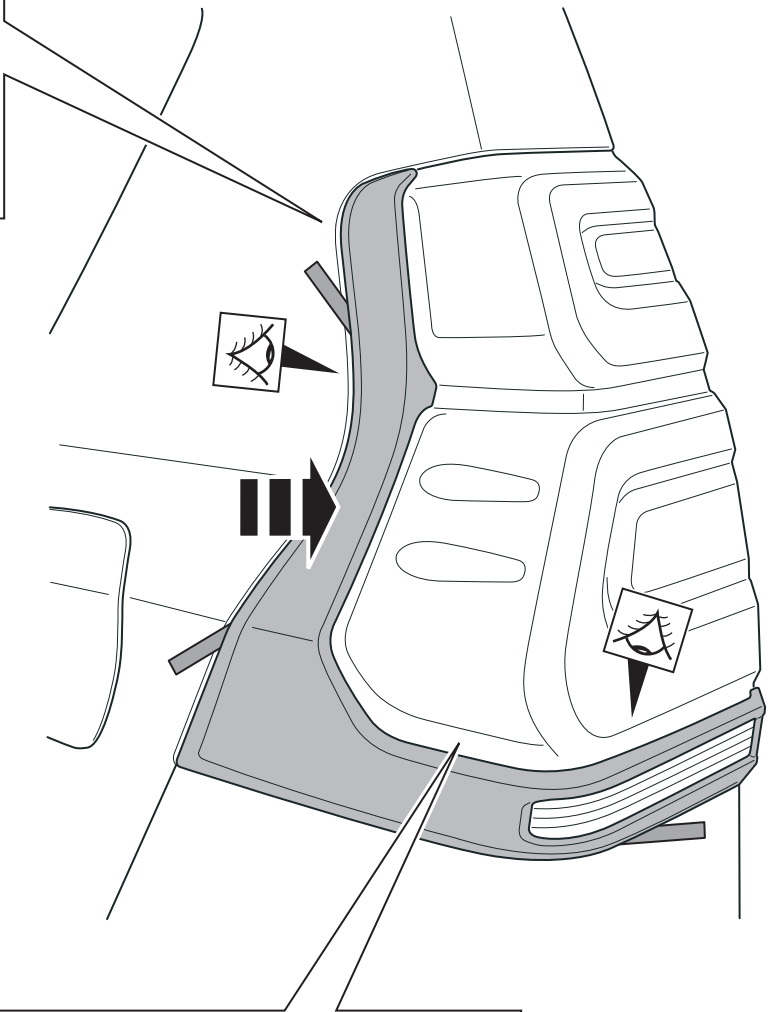
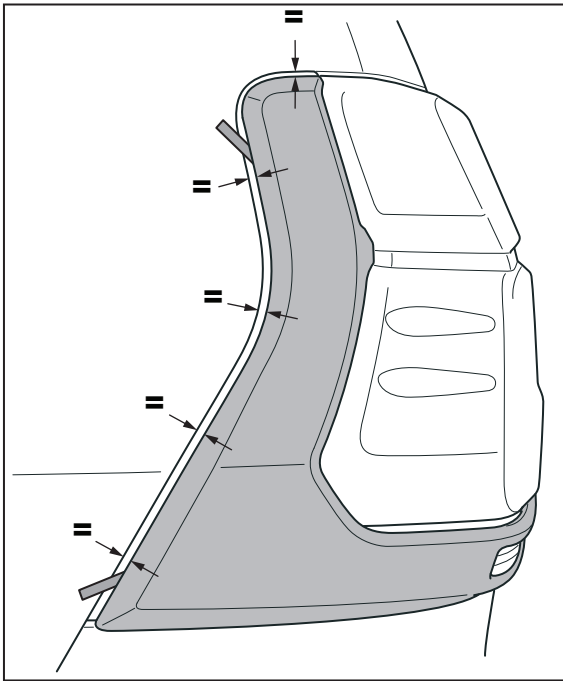

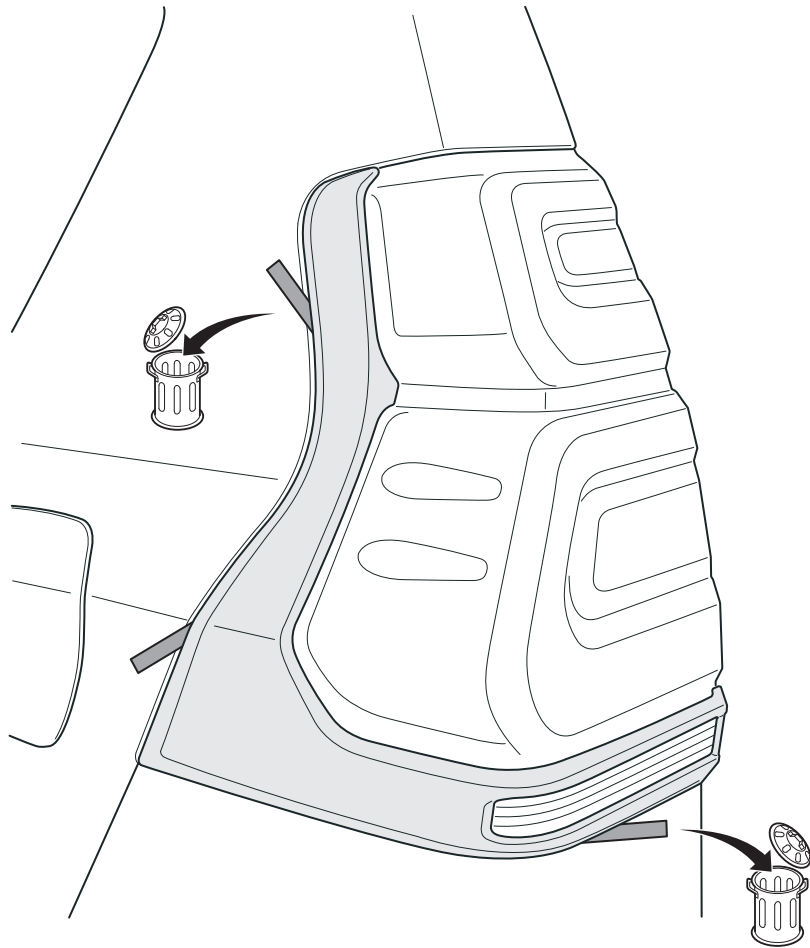

7

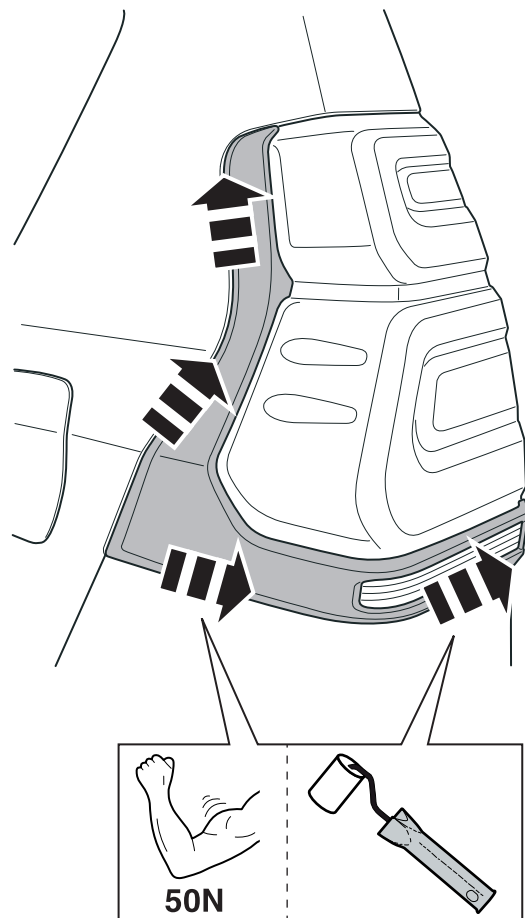

8

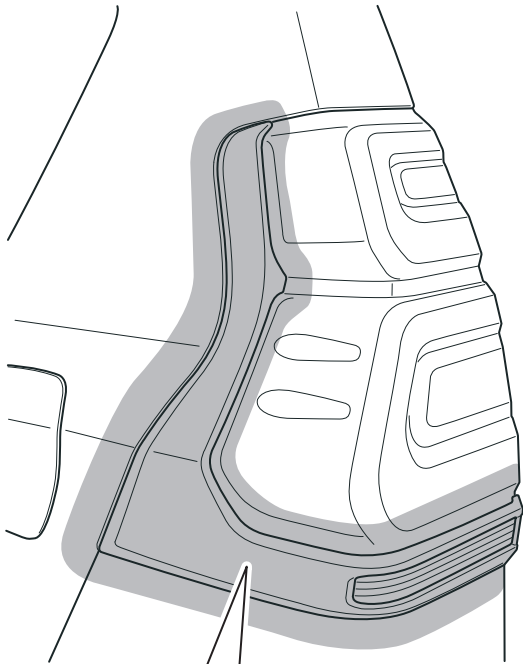

9

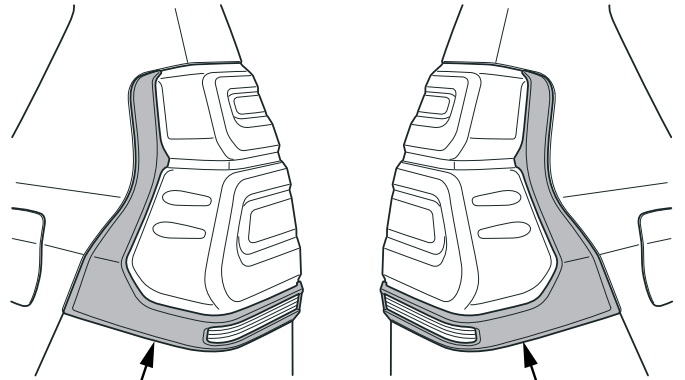

10

INFO

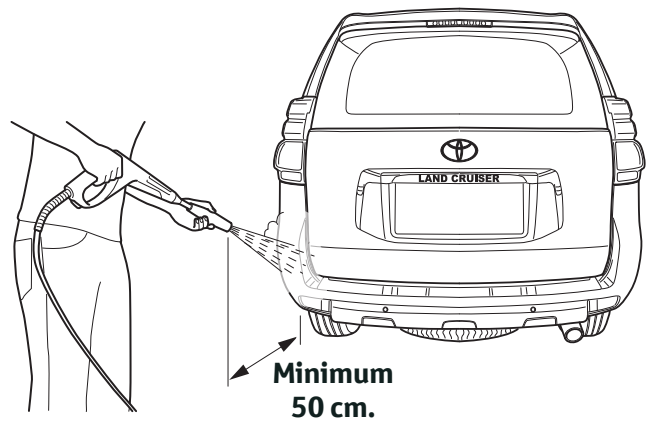
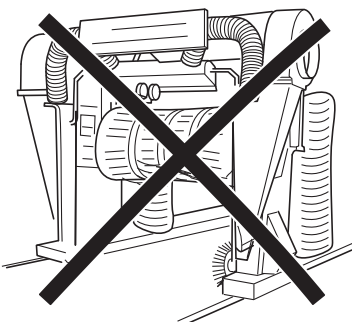
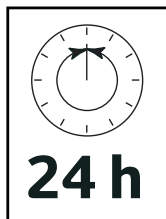
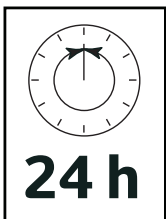
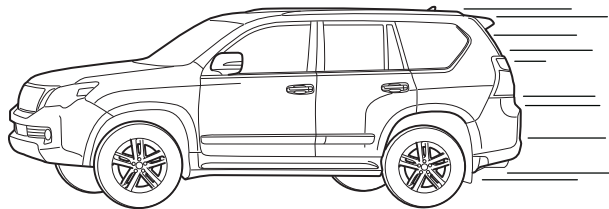
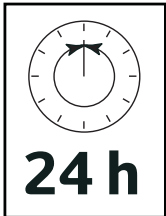

CHECK SHEET



TOYOTA

Model / Year **Land Cruiser**
2017/08

Rear lamp chrome bezel

VIN n°

ALWAYS A
BETTER WAY

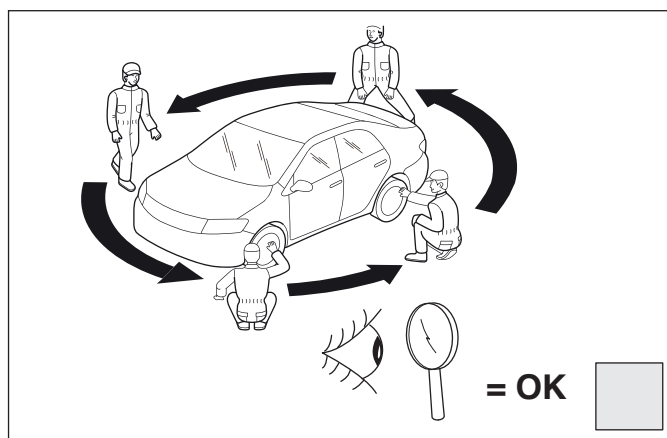
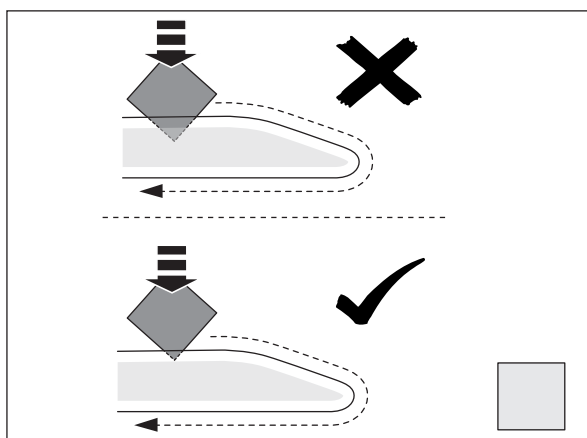
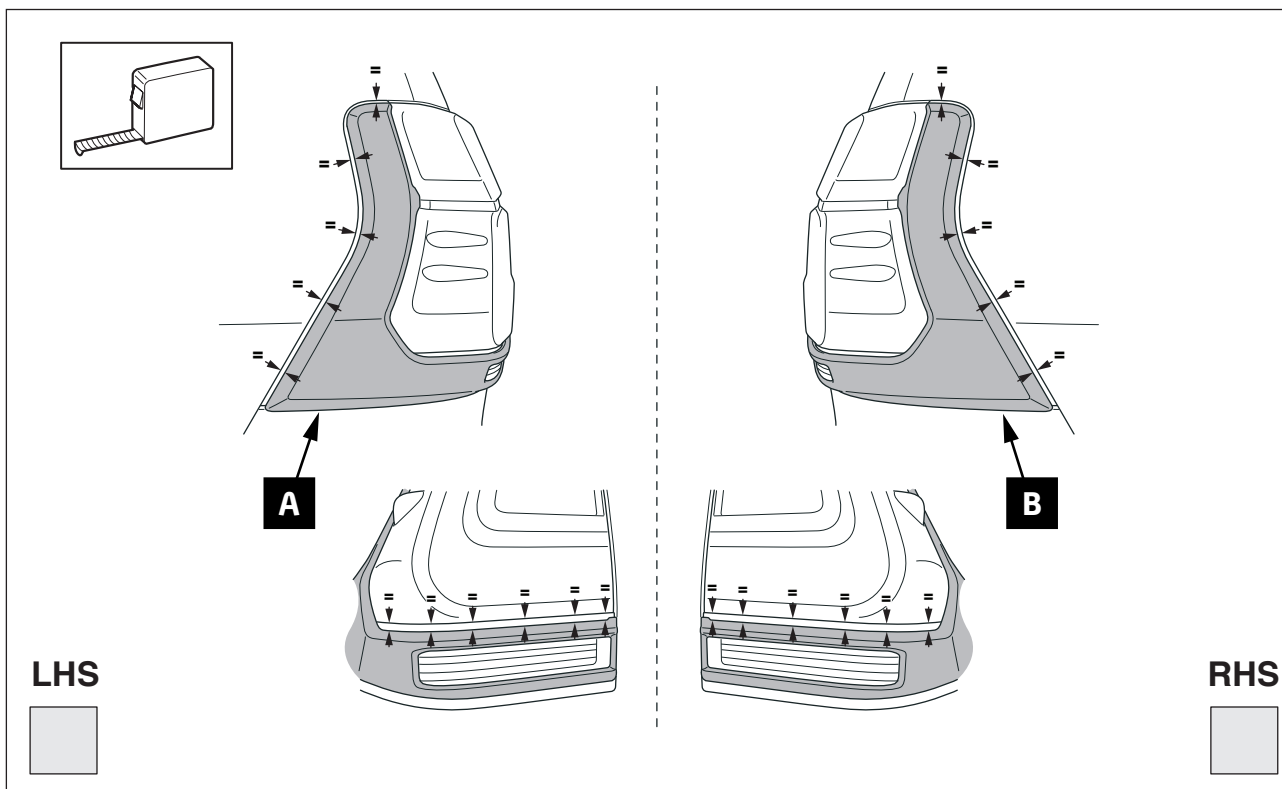
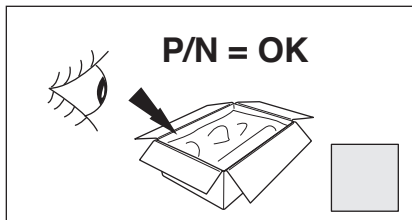

Installation Date:
... / ... / ...

Technician Name & Signature:

Stamp: