



TOYOTA

ALWAYS A
BETTER WAY

Hilux

Wind deflector

Installation instructions

Model year: as from 2015/06

Vehicle code: GUN1***-D***HW
GUN1***-D***XW











Part number: PC162-0K003

Manual reference number: AIM 003 603 - 1

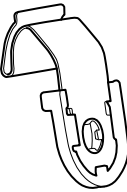
Revision Record

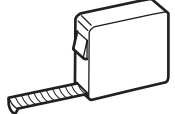
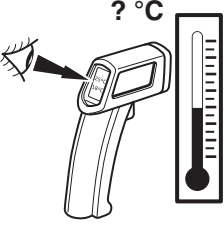
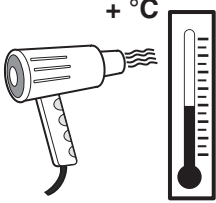
Rev. No.	Date	Page	Step	Remarks
①	09.03.20	1		Model year updated & vehicle code added
①	09.03.20	2		Kit & tools updated
①	09.03.20	3-10	1-5, 8-14	Info & steps updated
①	09.03.20	5, 6, 9	6, 7, 15	Steps added
①	09.03.20	15	C/S	CheckSheet updated

PC162-0K003

A	 PC162-0K00B	1x	B	 PC162-0K00D	1x
C	 PC162-0K00A	1x	D	 PC162-0K00C	1x
E				PC162-0K00G	8x
					
				PZ415-00000-00  3M adhesion promoter 4298 UV	
				  AIM 003-516-*	



Material Safety Data Sheet

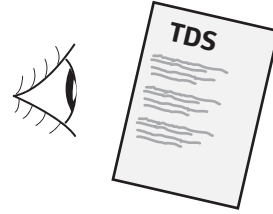

Technical Data Sheet

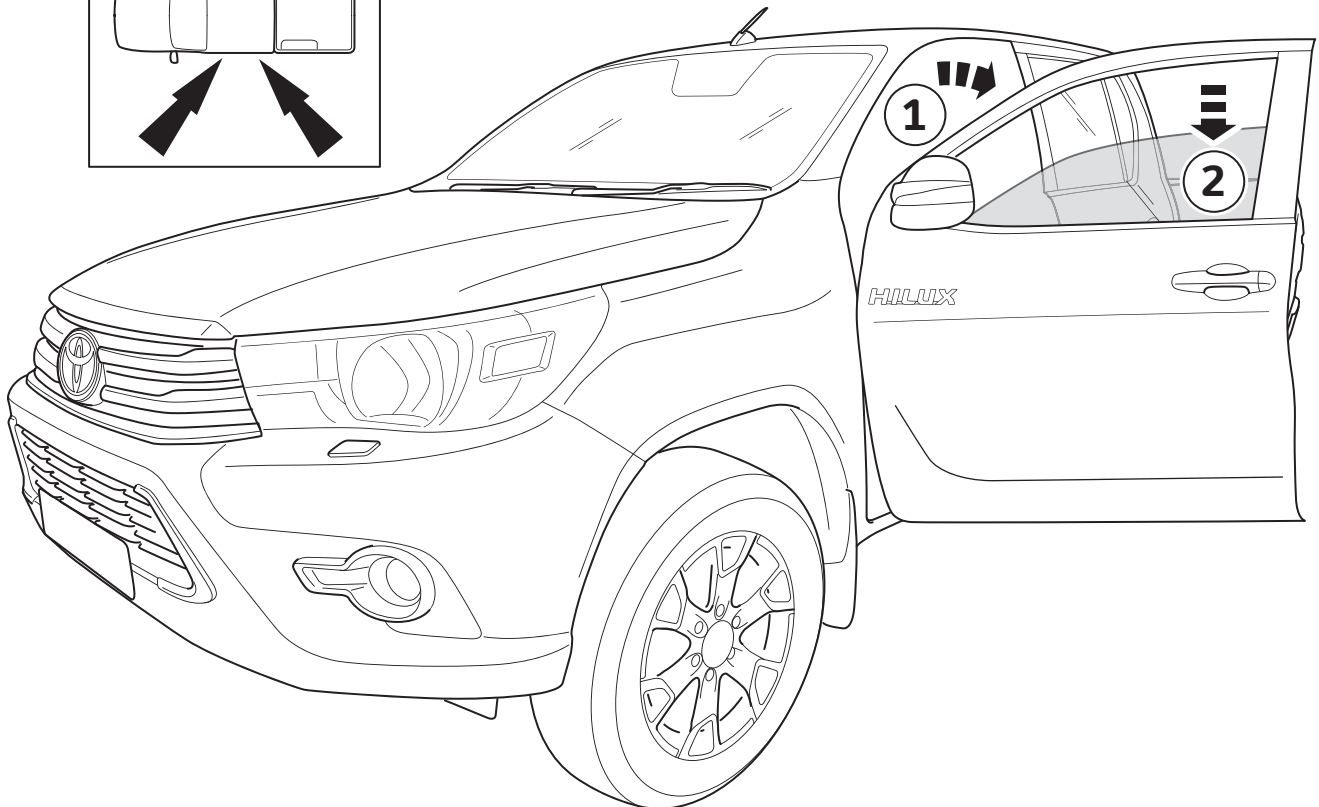
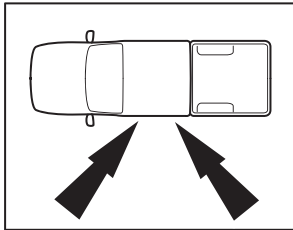
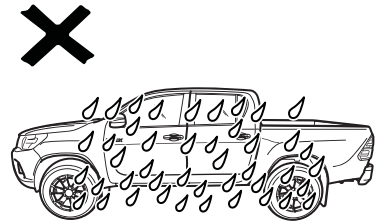
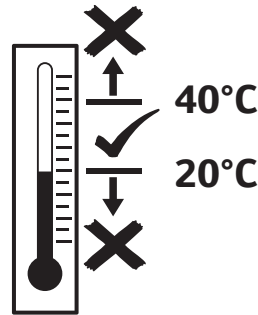
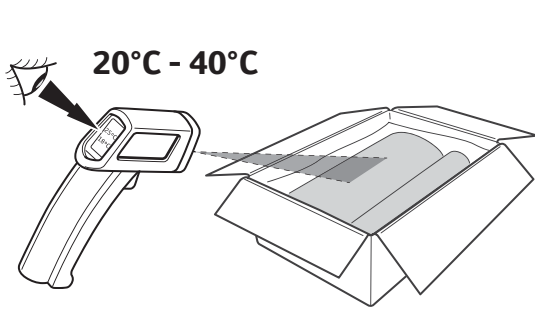
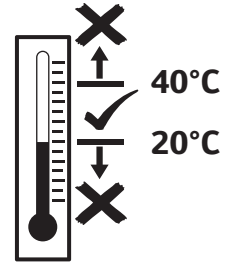
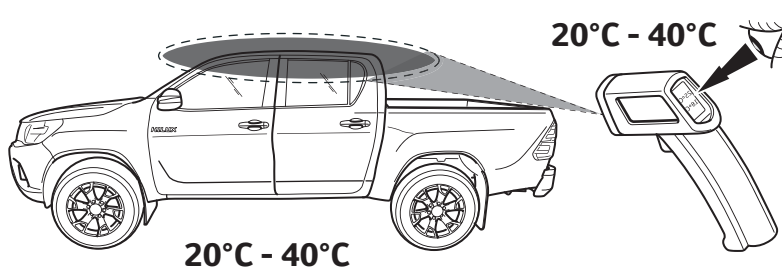

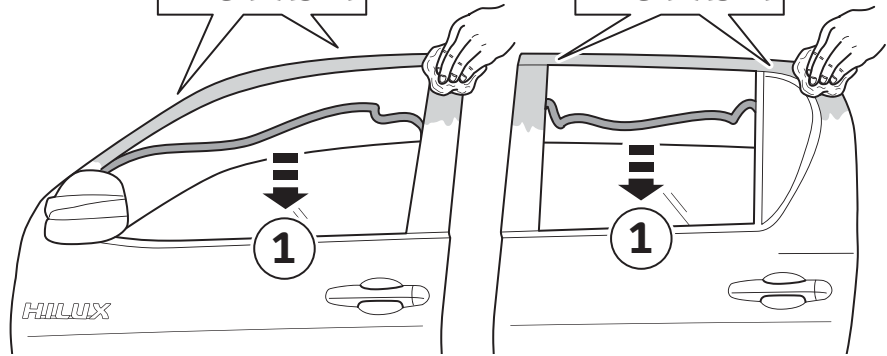
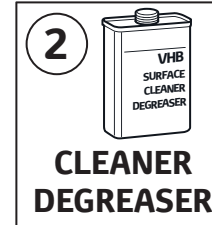
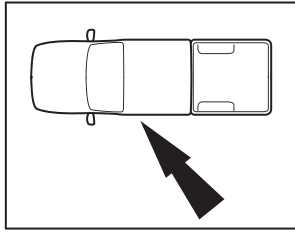

2

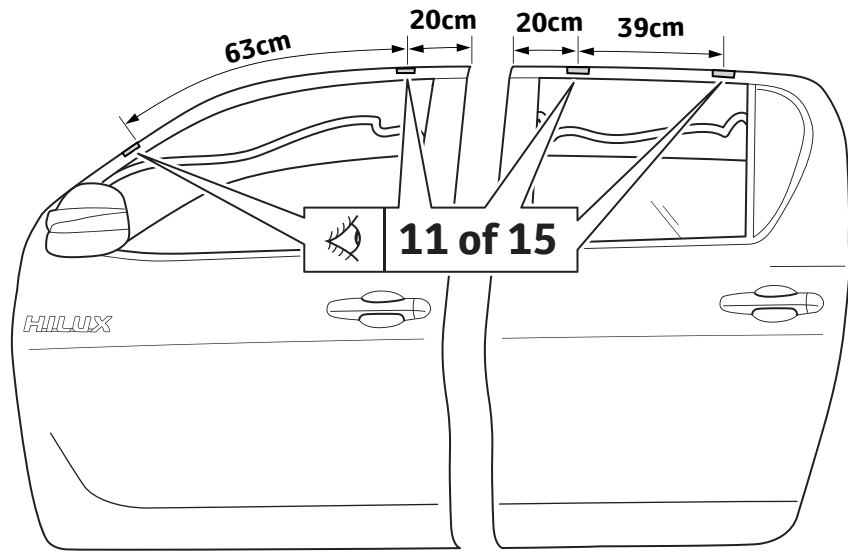
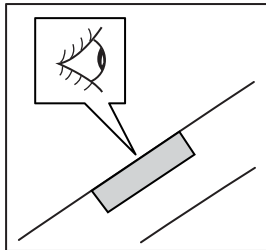
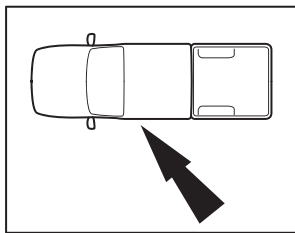

3

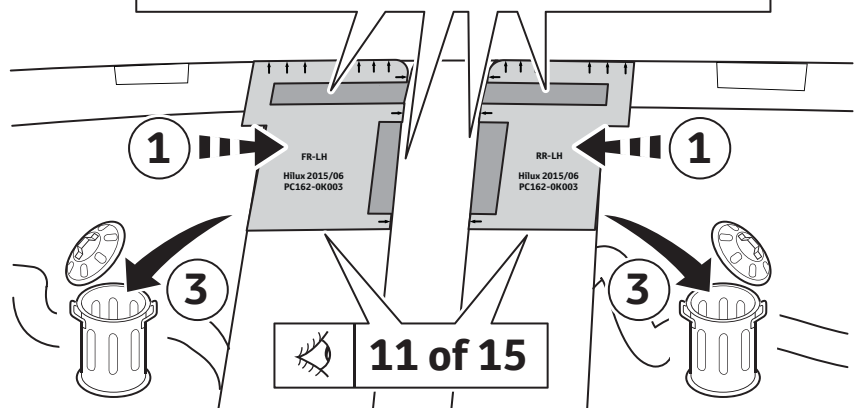
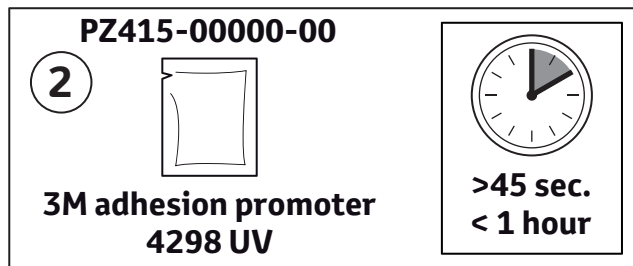
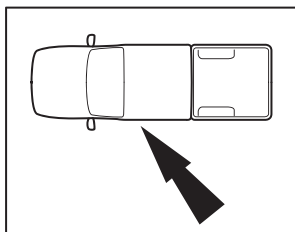

4

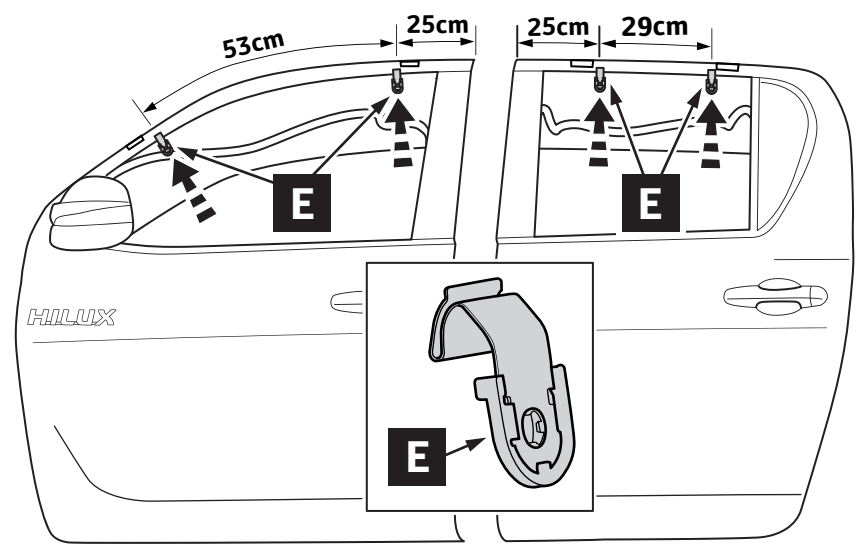
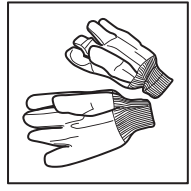
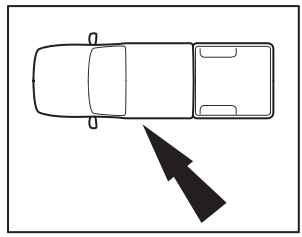

5

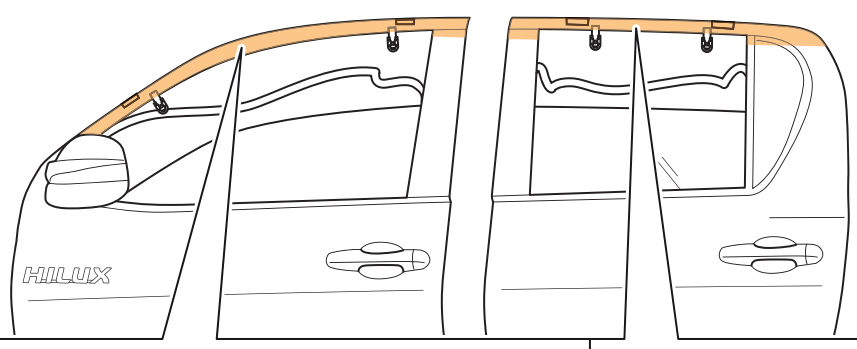

<p>1</p> <p>? °C</p>	<p>< 20°C → 2</p> <p>20°C - 40°C → 7</p>	<p>2</p> <p>+ °C</p>
<p>3</p> <p>? °C</p>	<p>20°C - 40°C → 7</p>	<p>INFO</p>

6

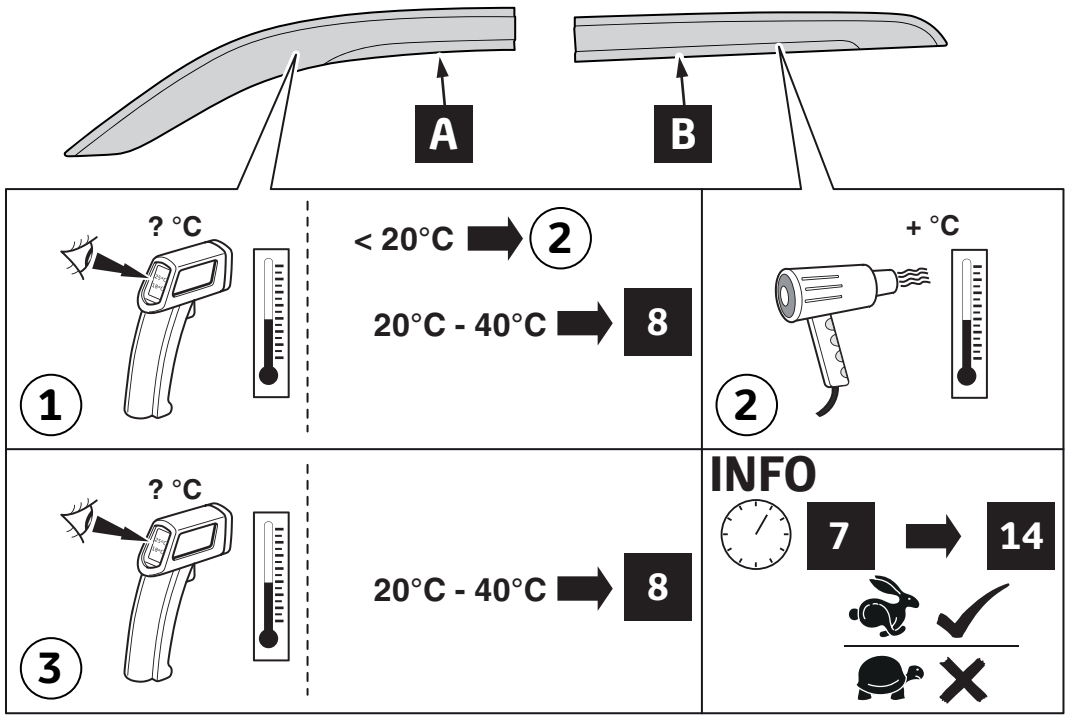

7

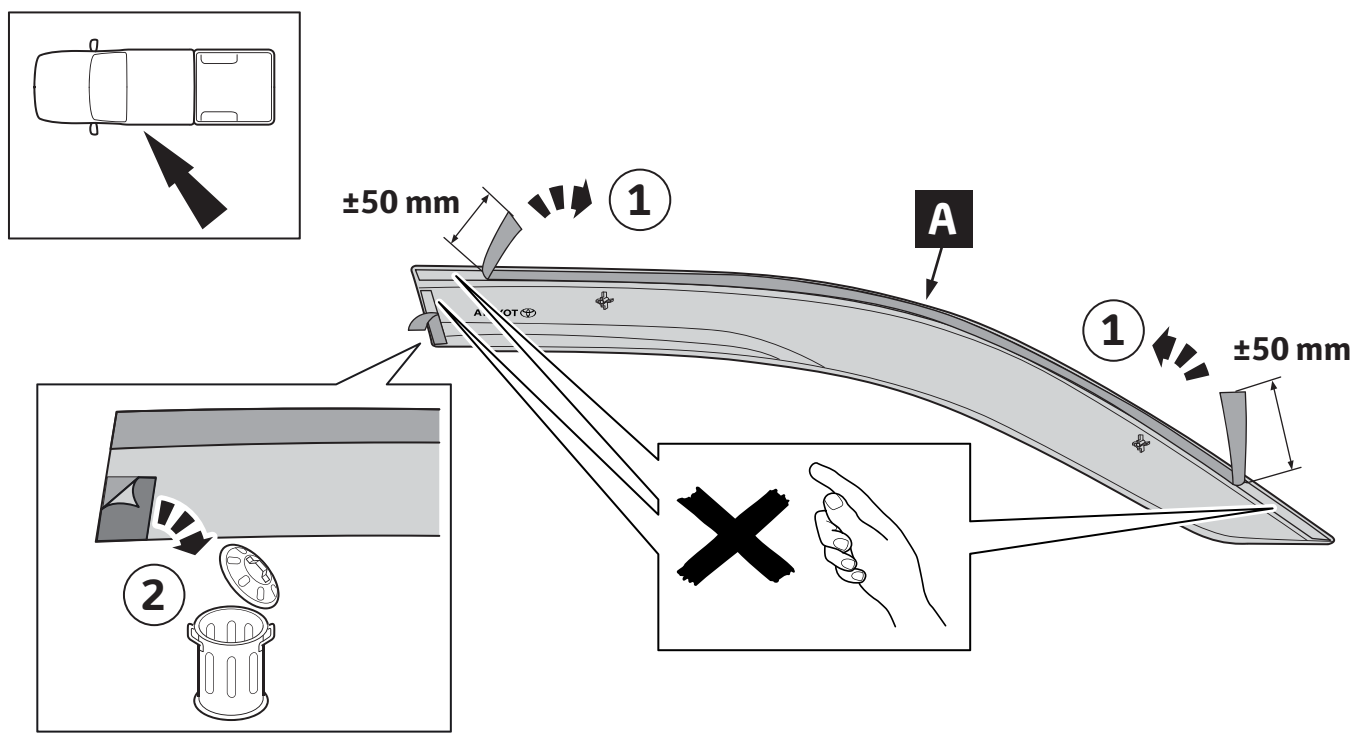

8



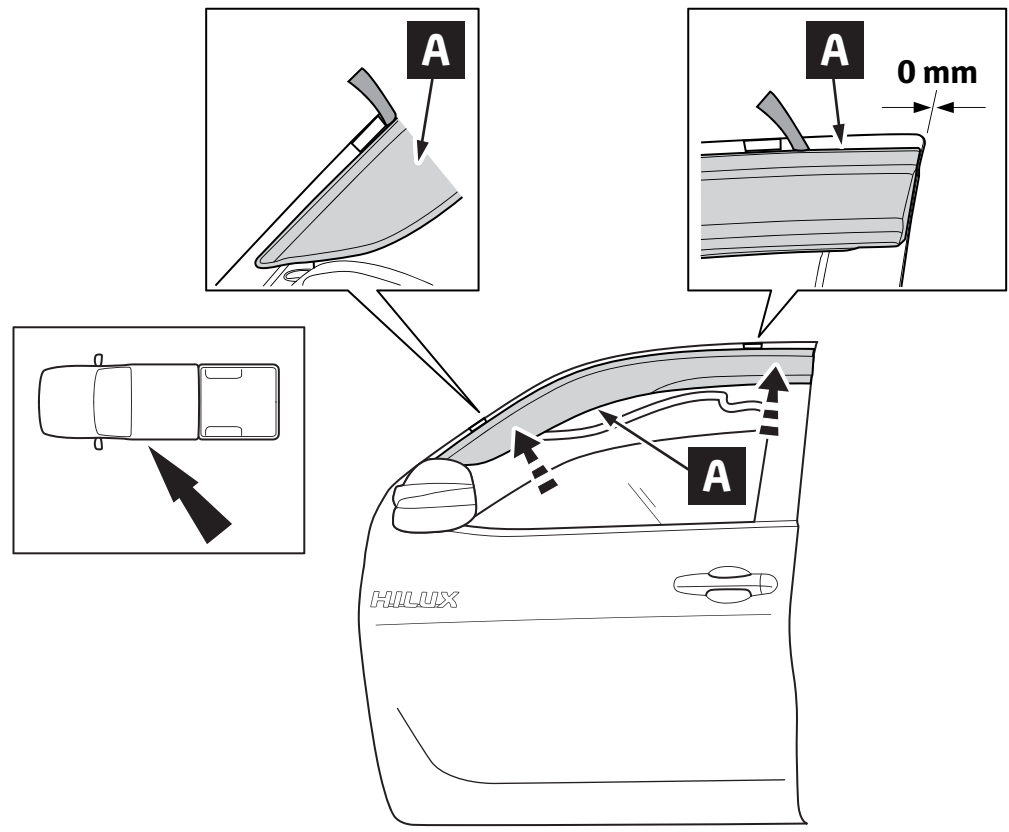

9

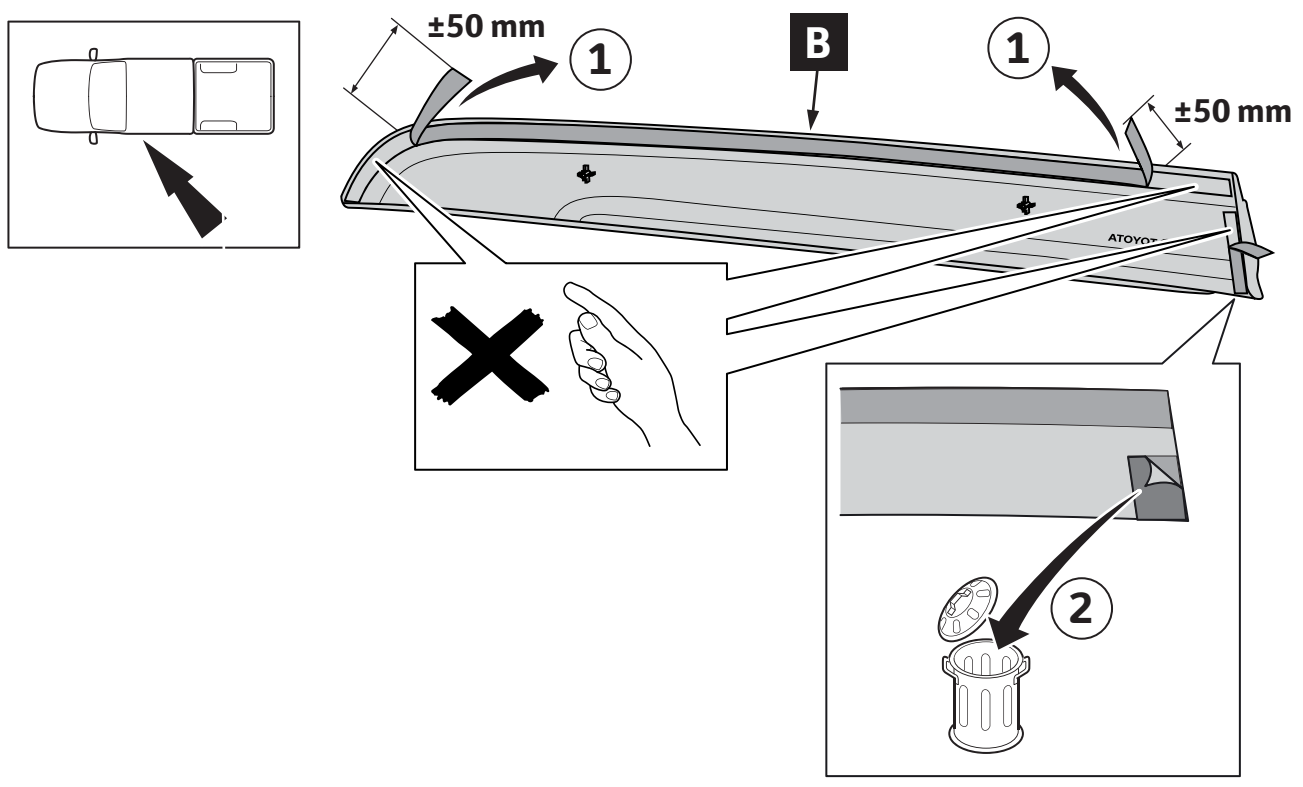

10

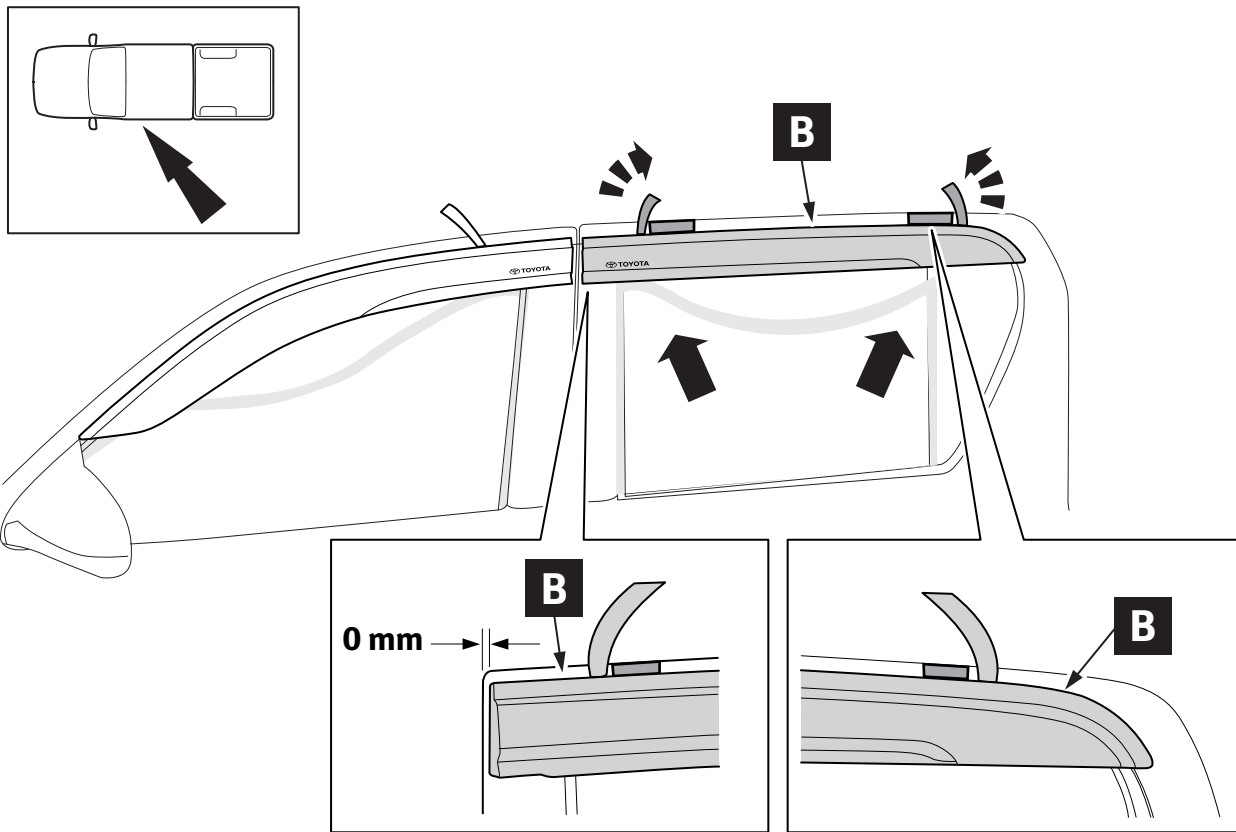

11

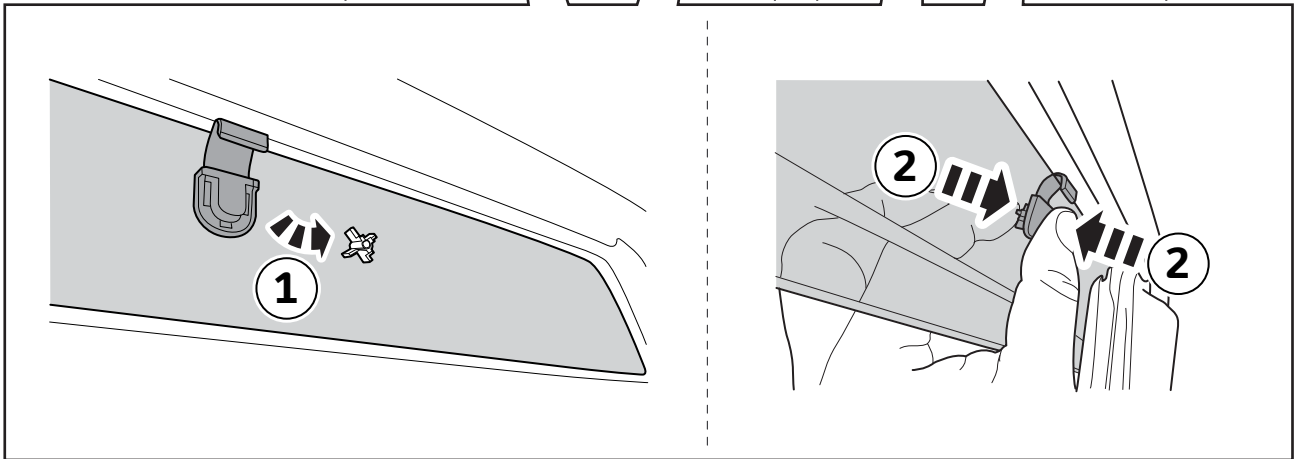
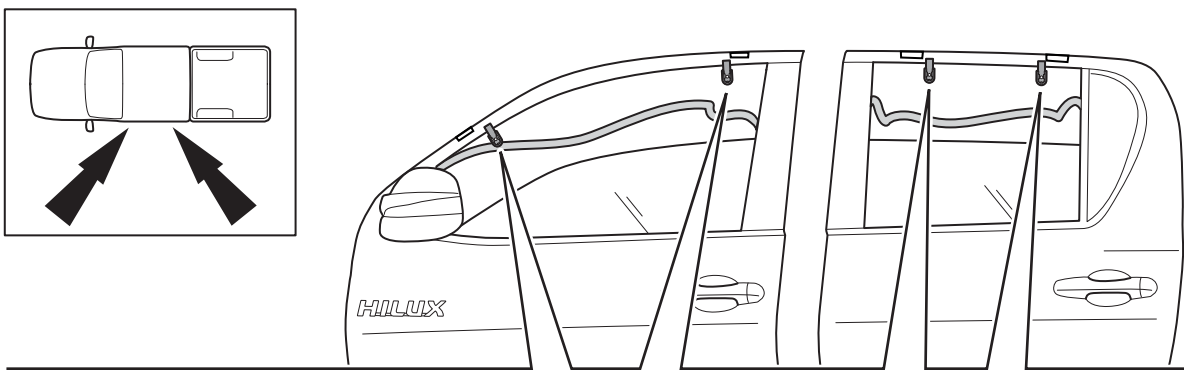

12

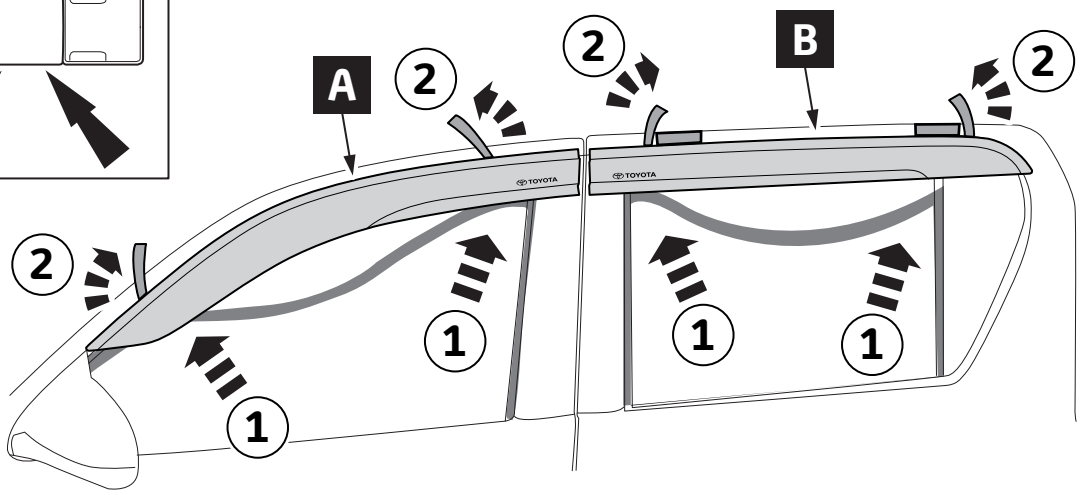
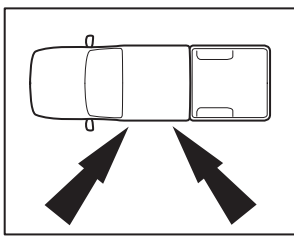

13

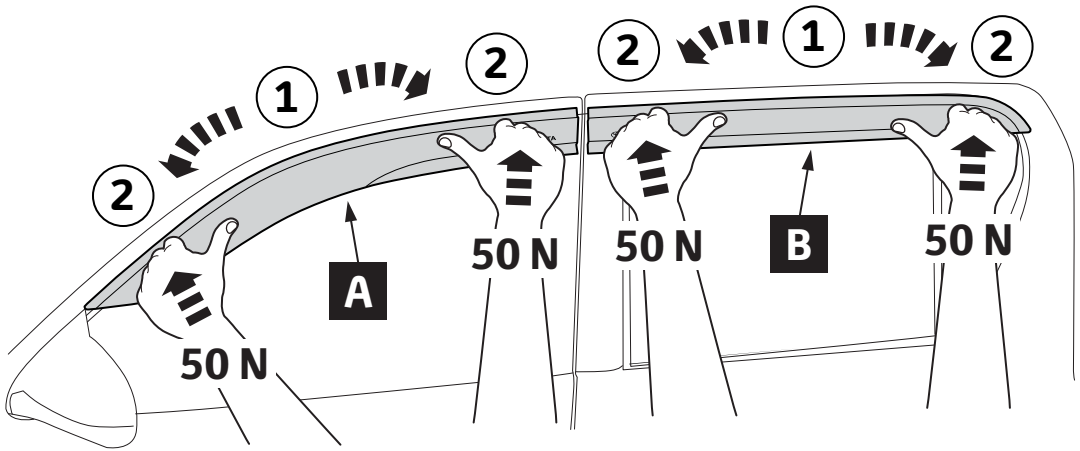
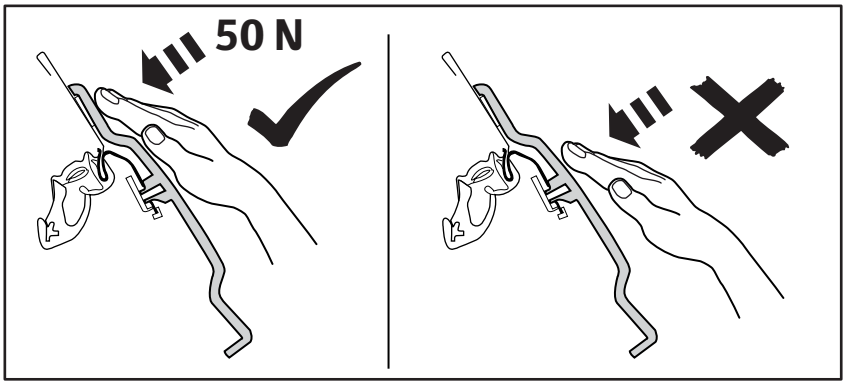
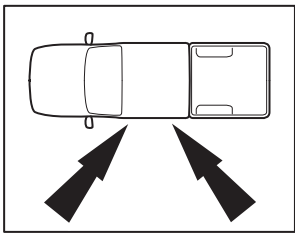

14

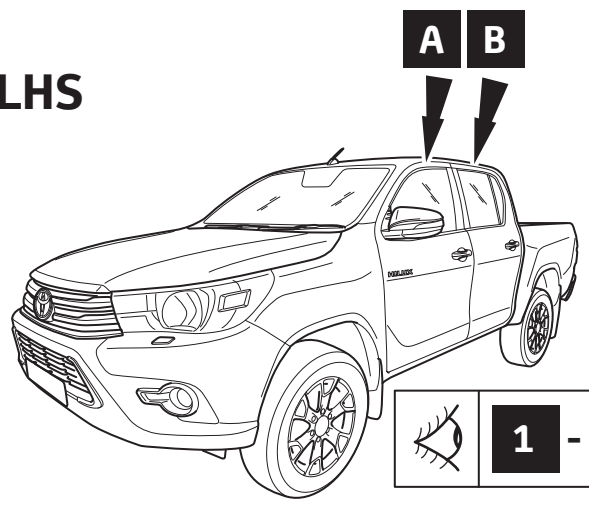
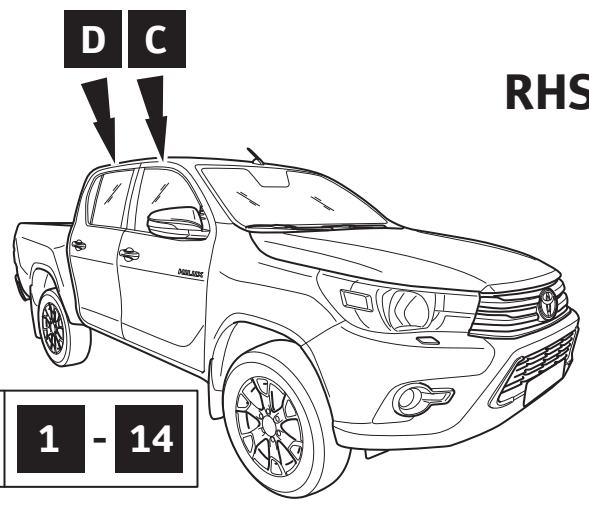

RHS = LHS



1 - 14



1 - 14

15



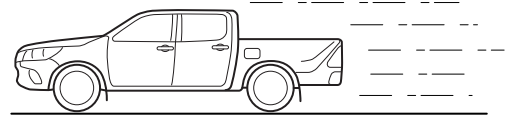
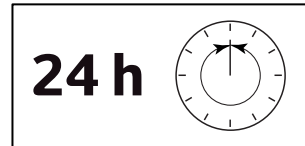
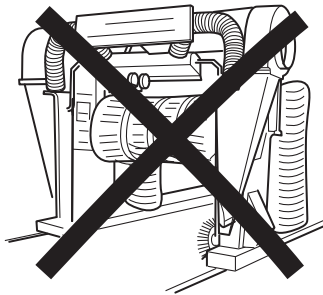
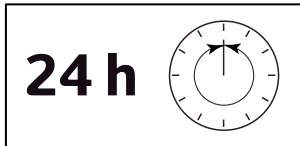
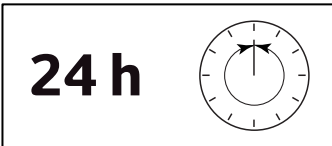

Max. 90 Km/h

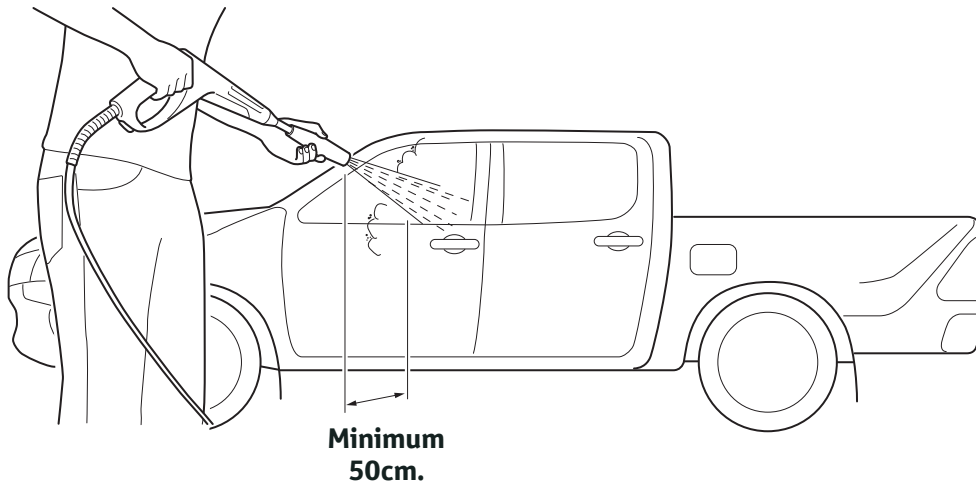

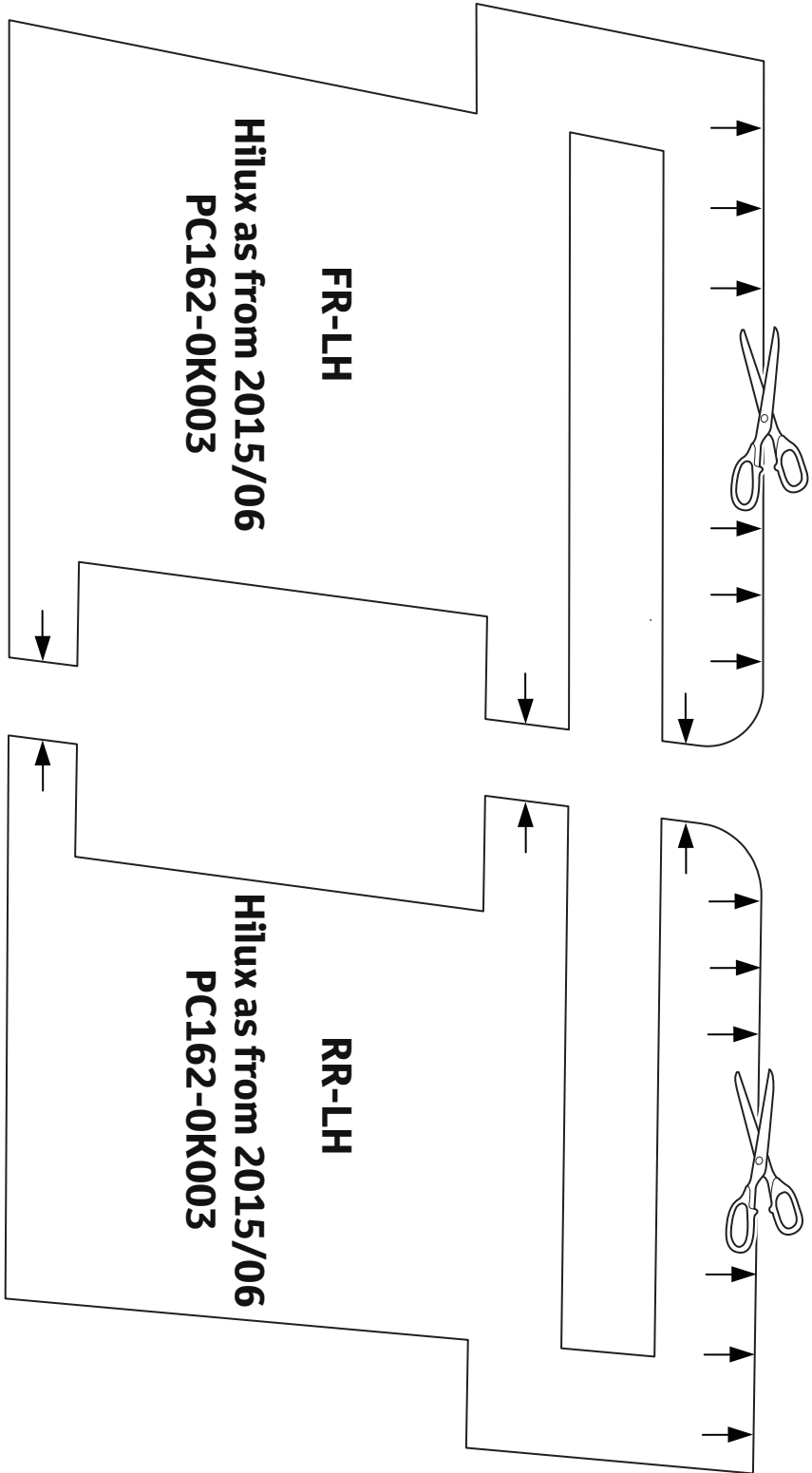
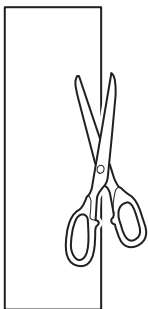
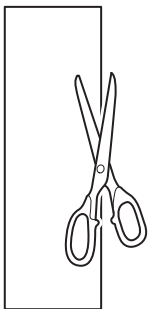
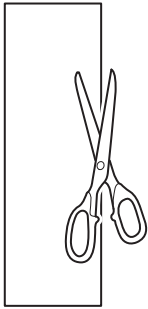
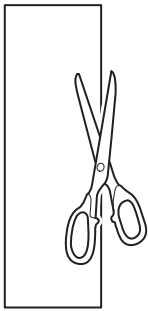

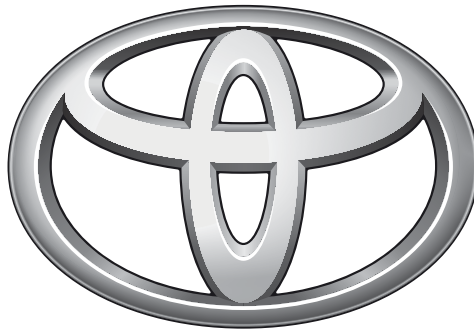

CHECK

Print 100%
Check with Rulers
before use.



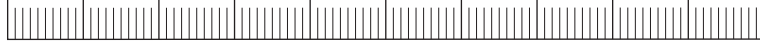

TOYOTA

0 10 20 30 40 50 60 70 80 90 100

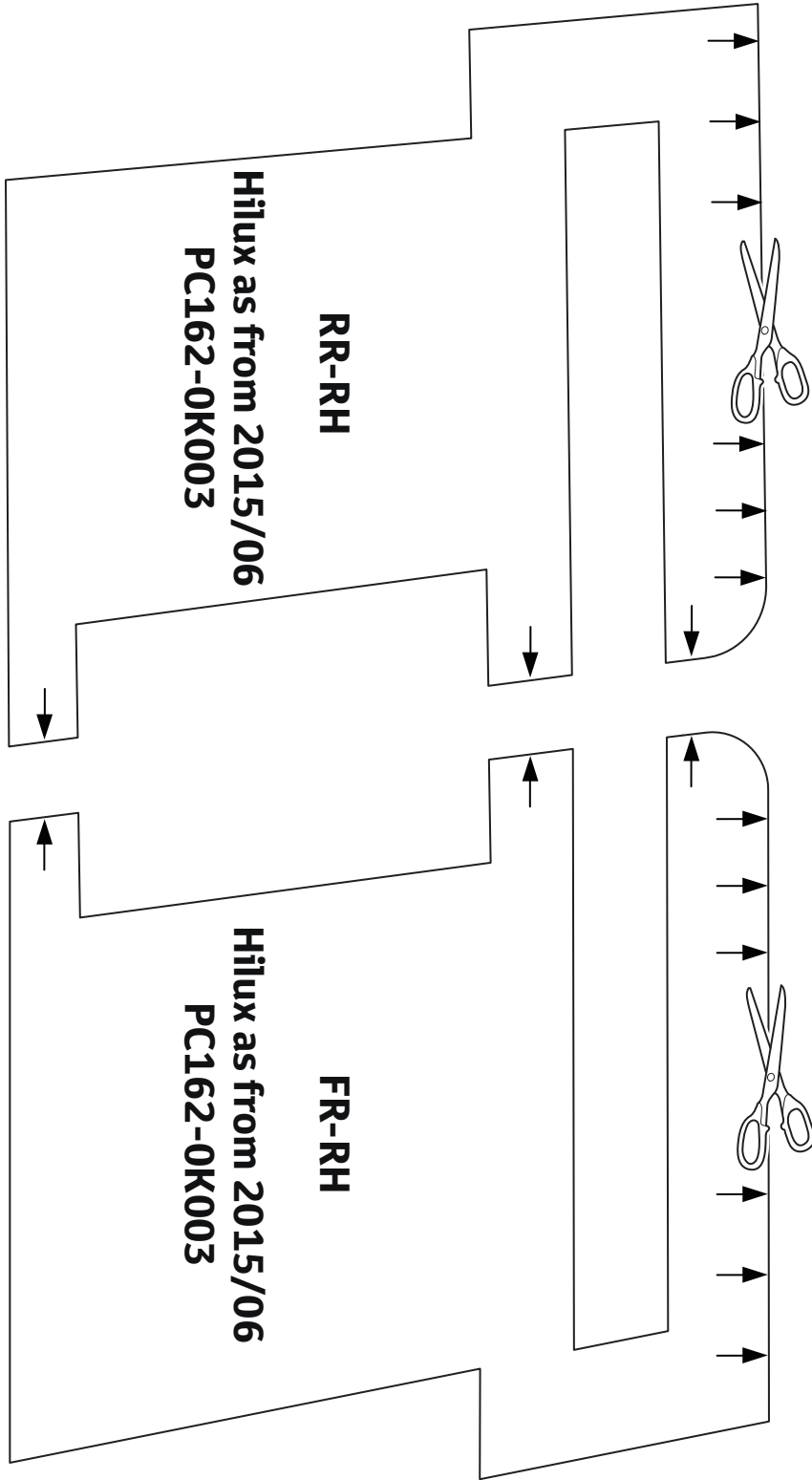

100 96 88 80 70 60 50 40 30 20 10 0



CHECK

Print 100%
 Check with Rulers
 before use.

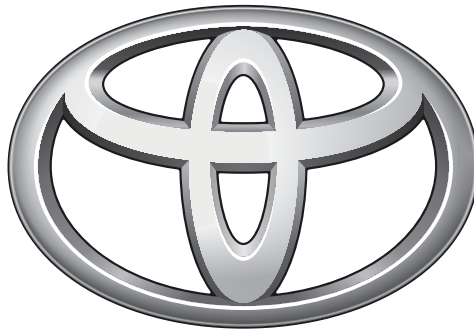

TOYOTA

CHECK SHEET Page 1 of 1



TOYOTA

ALWAYS A
BETTER WAY

Model / Year Hilux **Wind deflectors**
as from 2015/06

VIN n°

DURING INSTALLATION

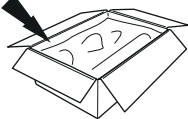
1  **P/N = OK** 

AFTER INSTALLATION

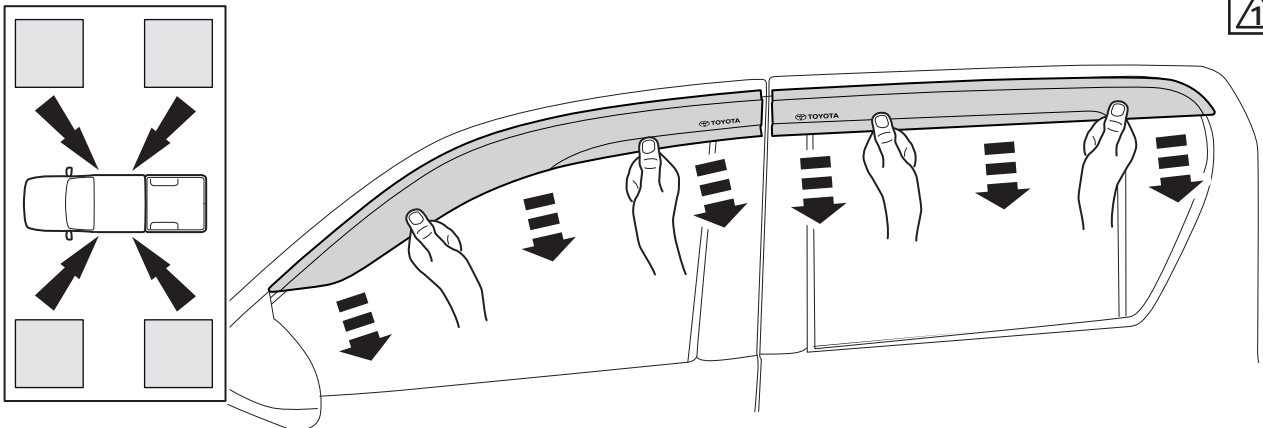
1 

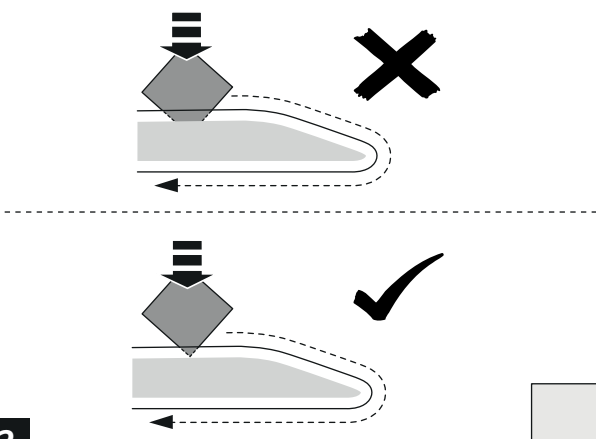
2 

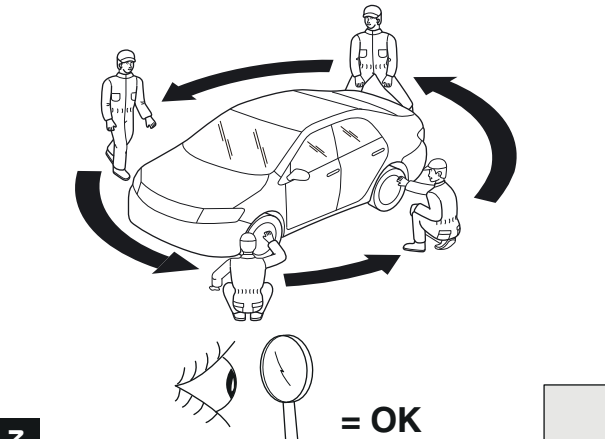
3 

Installation Date:
... / ... / ...

Technician Name & Signature:

Stamp:

