



**TOYOTA**

ALWAYS A  
**BETTER WAY**

# Corolla

## Roof Protection Film

Installation Instructions

Model year: As from 2019/05

Vehicle code:  
NRE210\*-D\*\*\*ZW  
ZWE211\*-DHX\*BW  
MZEH12\*-DHX\*BW  
MZEA11\*-DE\*\*BW  
ZRE210L-DE\*\*PW  
ZWE21\*\*-DE\*\*\*W

Part number: PW17A-02000

Manual reference number: AIM 006 065-1

# Revision record

Rev. No.	Date	Page	Step	Remarks
△ <sub>1</sub>	04.12.2020	1		Vehicle codes added.
△ <sub>1</sub>	04.12.2020	3, 4	Info, 2, 3	Temperature range updated

## PW17A-02000



**A**

1x

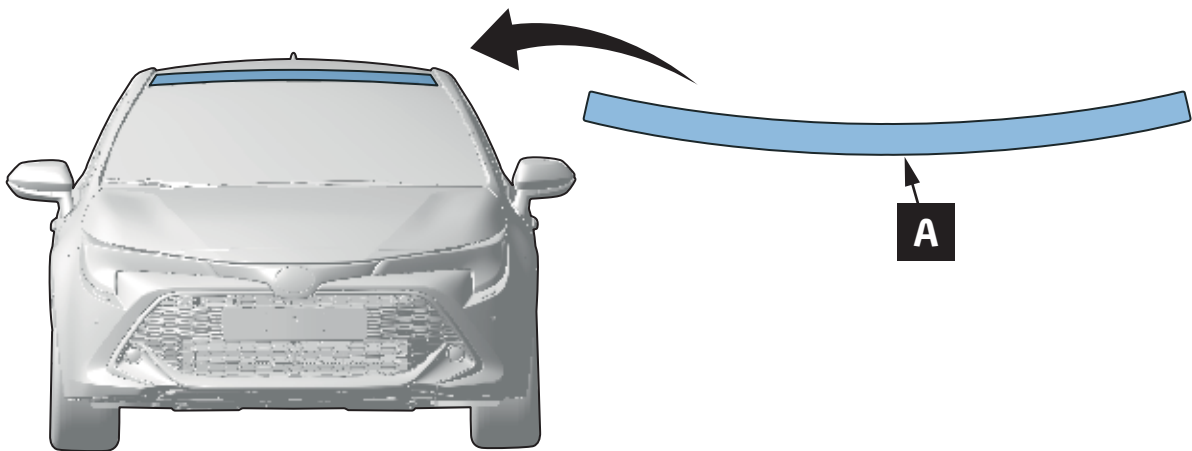

  
**3M Gold squeegee + Low friction sleeve  
NOT INCLUDED**

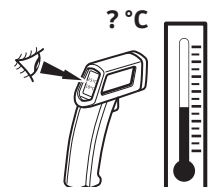
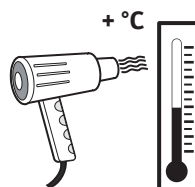

**INFO**



**Material Safety Data Sheet**



**Technical Data Sheet**

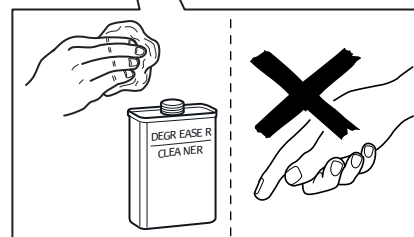
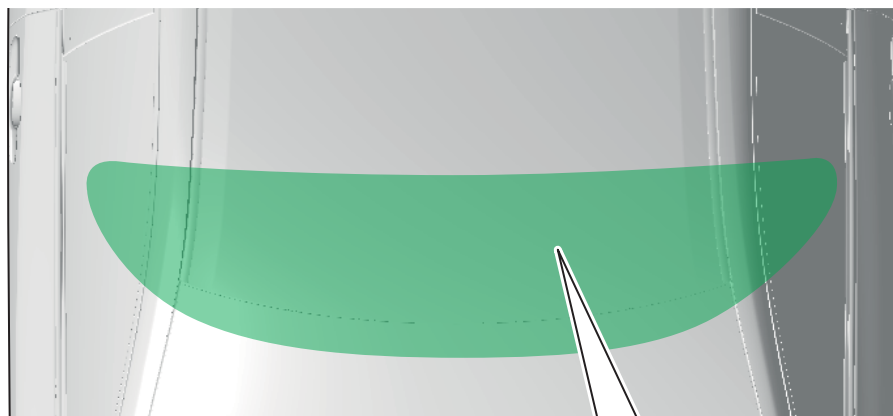
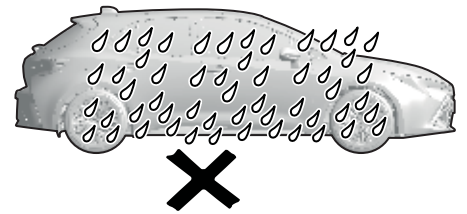
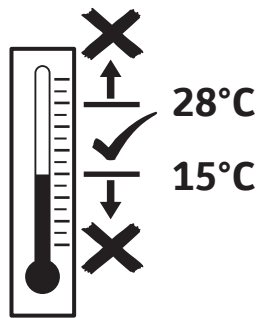
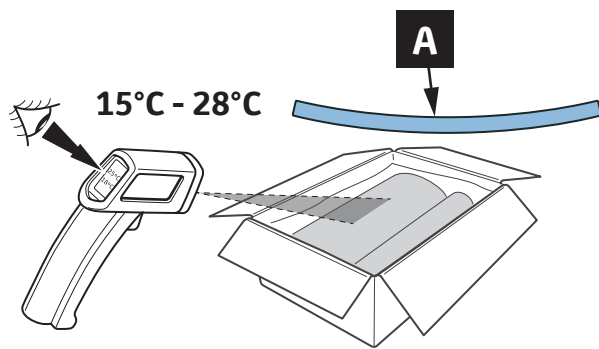
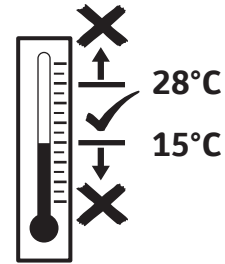
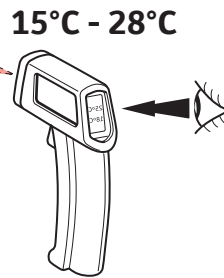
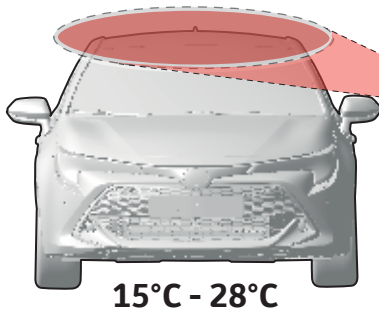

**1**

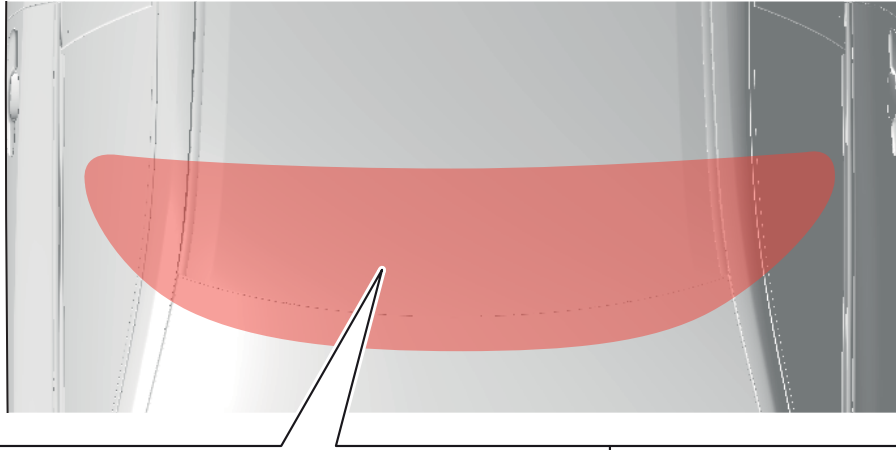

<p>1</p>	<p>? °C</p> <p>&gt; 15°C → 2</p> <p>15°C - 28°C → 3</p>	<p>2</p> <p>+ °C</p>
<p>3</p>	<p>? °C</p> <p>15°C - 28°C → 3</p>	<p>INFO</p>

2

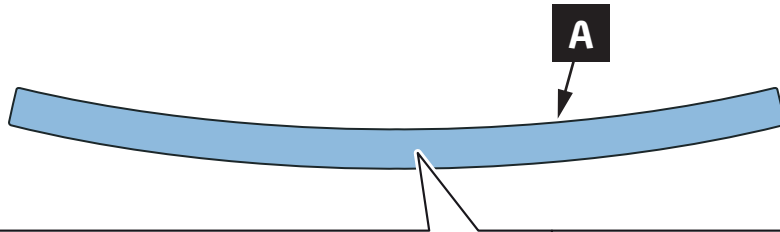

<p>1</p>	<p>? °C</p> <p>&gt; 15°C → 2</p> <p>15°C - 28°C → 4</p>	<p>2</p> <p>+ °C</p>
<p>3</p>	<p>? °C</p> <p>15°C - 28°C → 4</p>	<p>INFO</p>

3

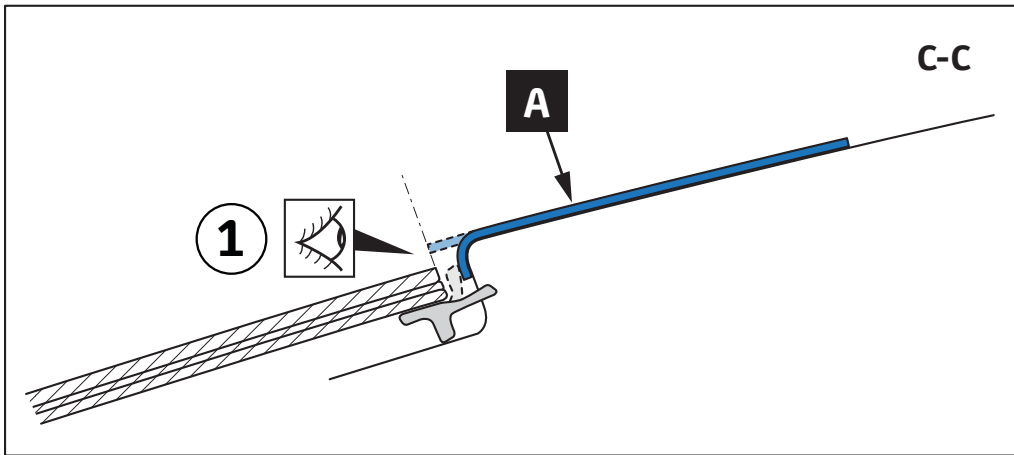
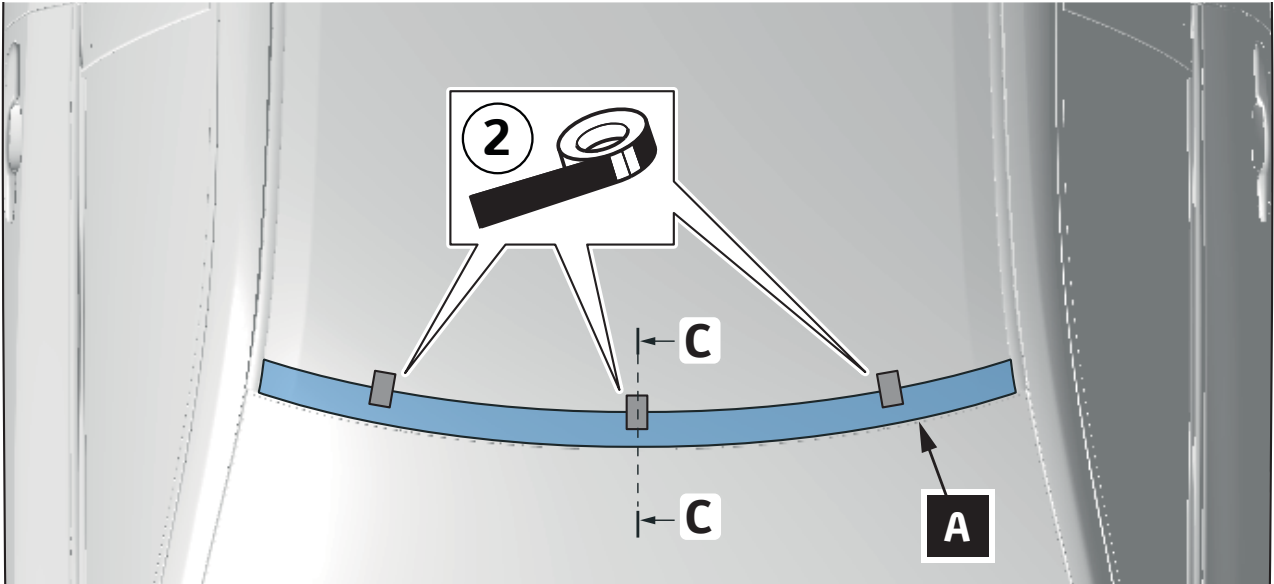

4

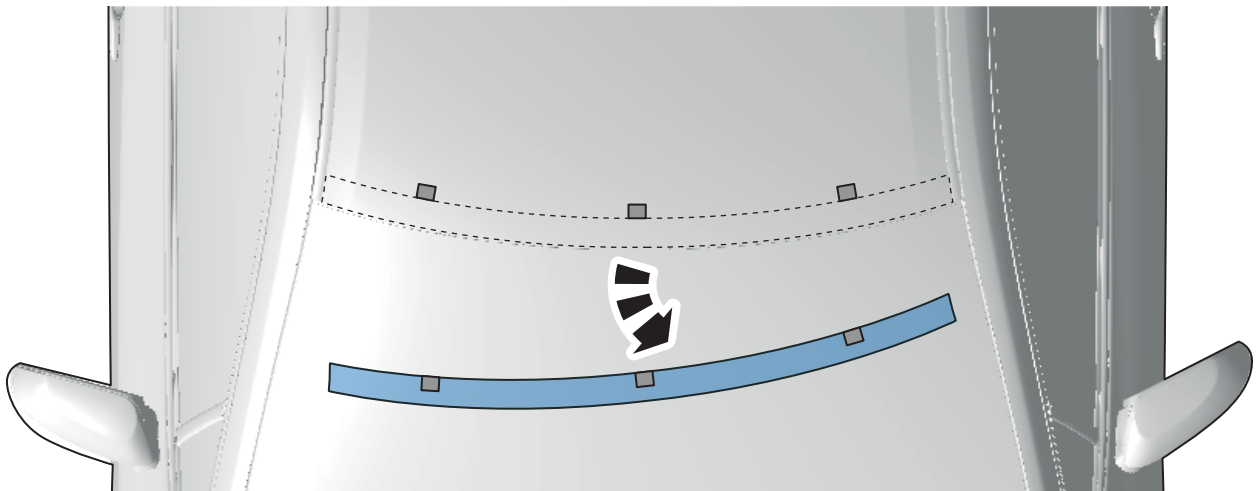

5

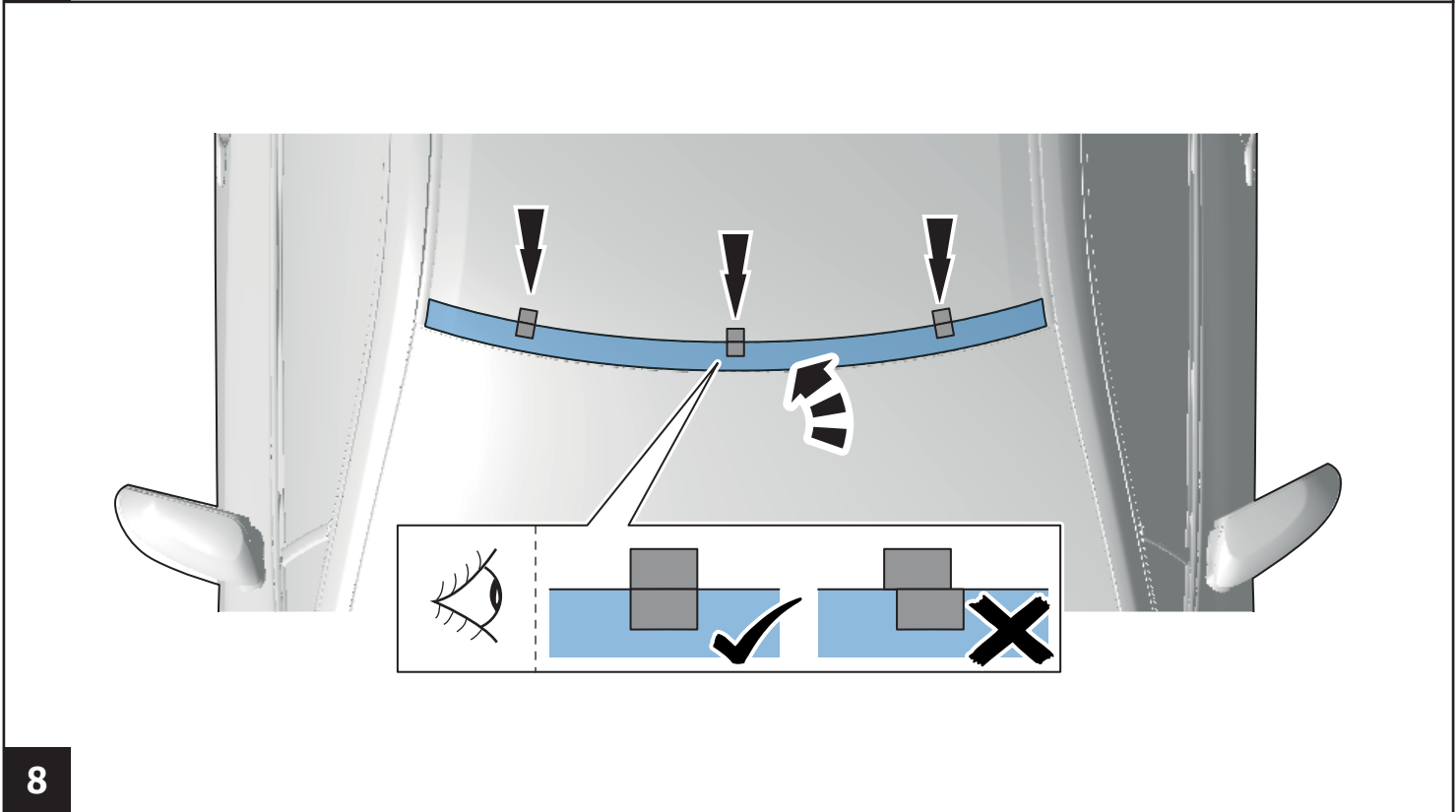
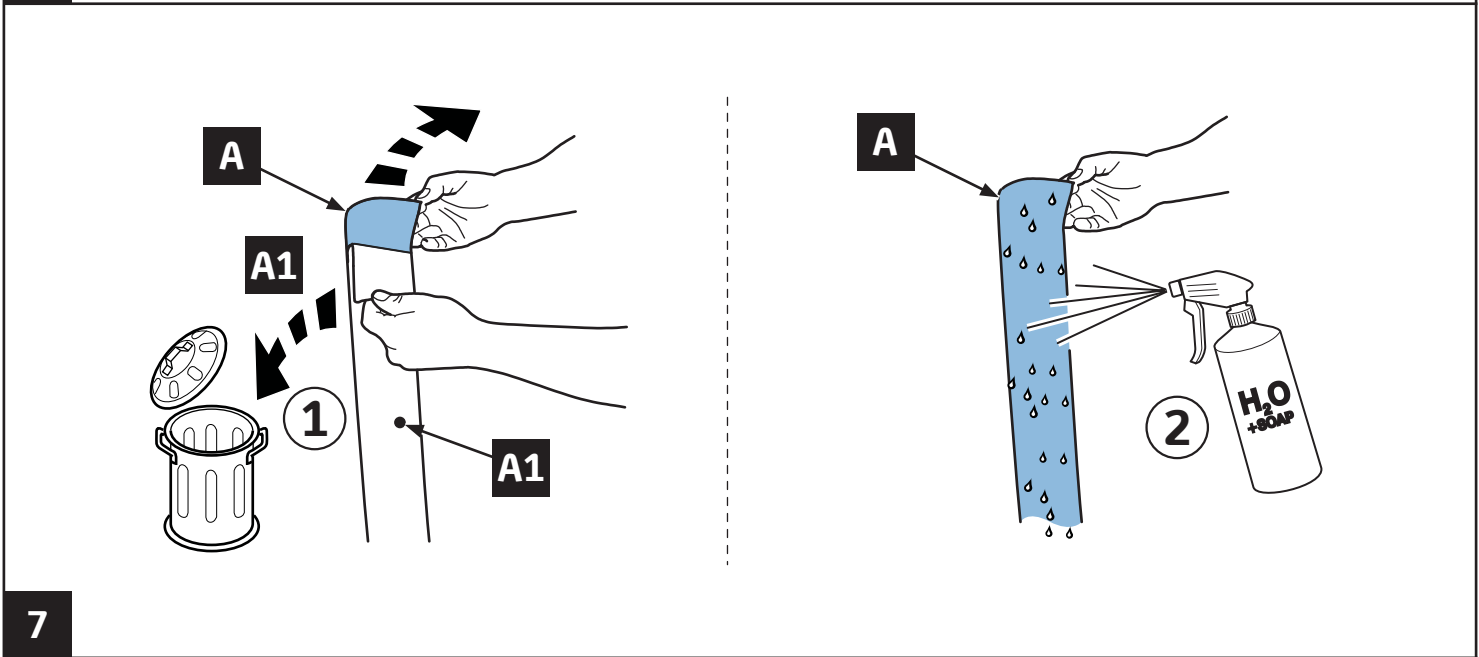
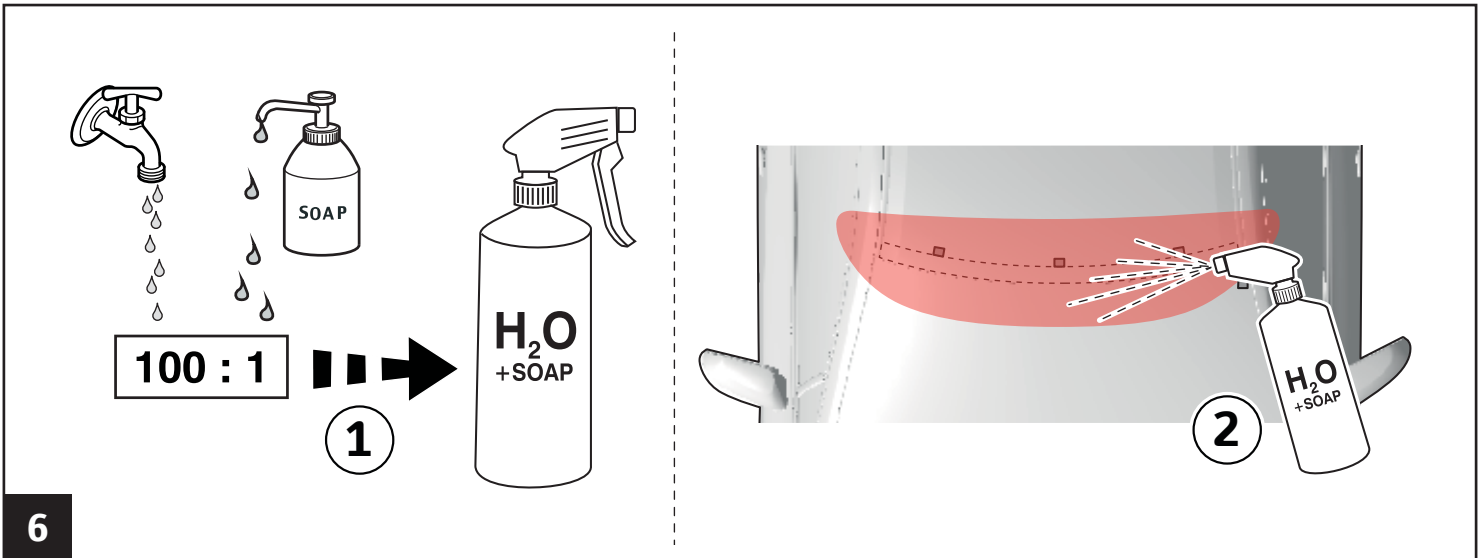

  
**3M Gold squeegee + Low friction sleeve**

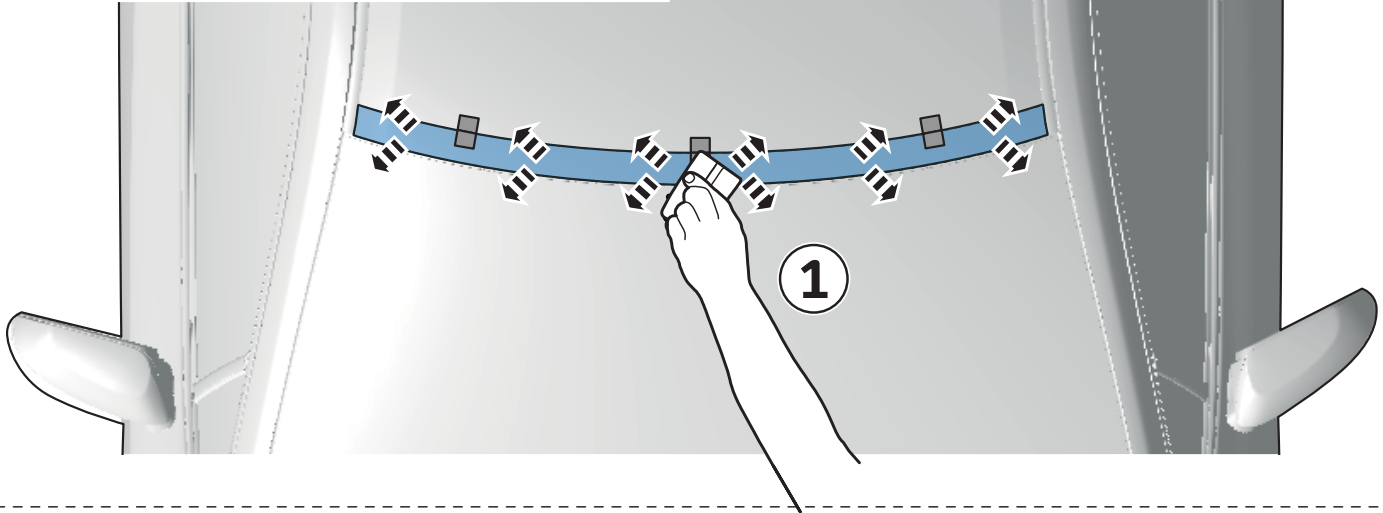

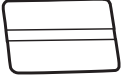
  
**3M Gold squeegee**

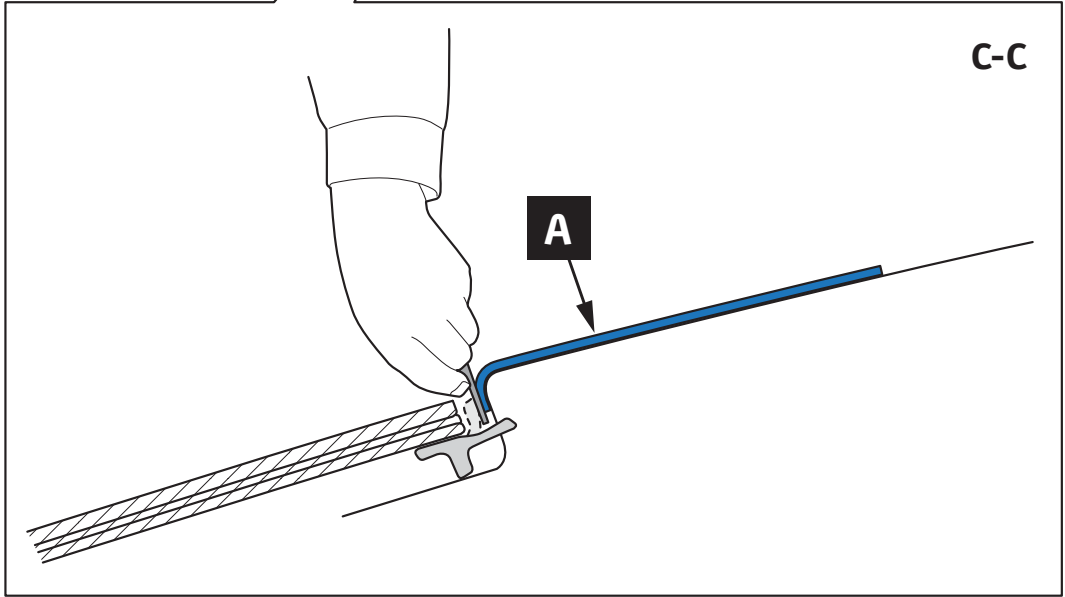
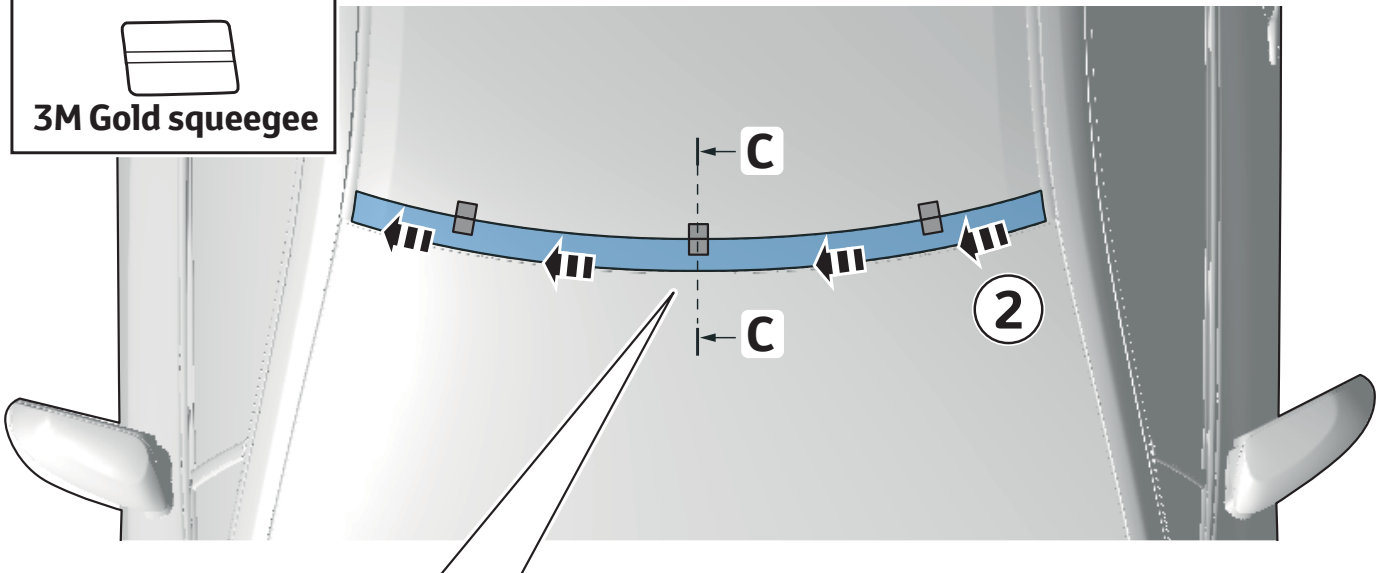

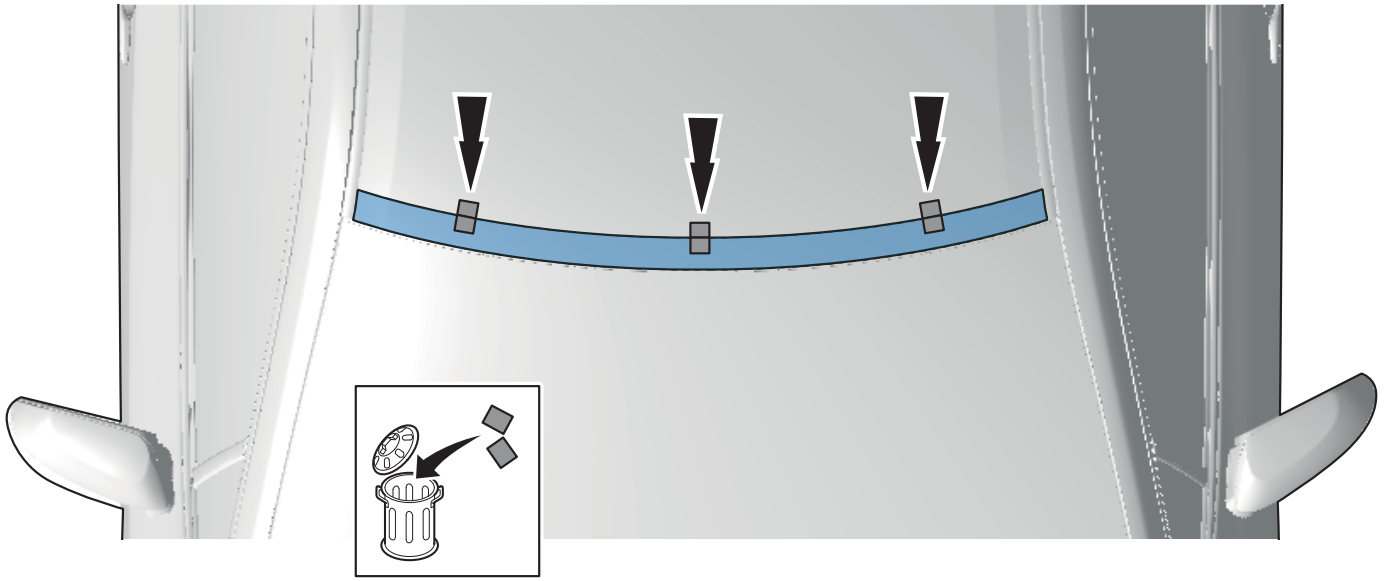

10

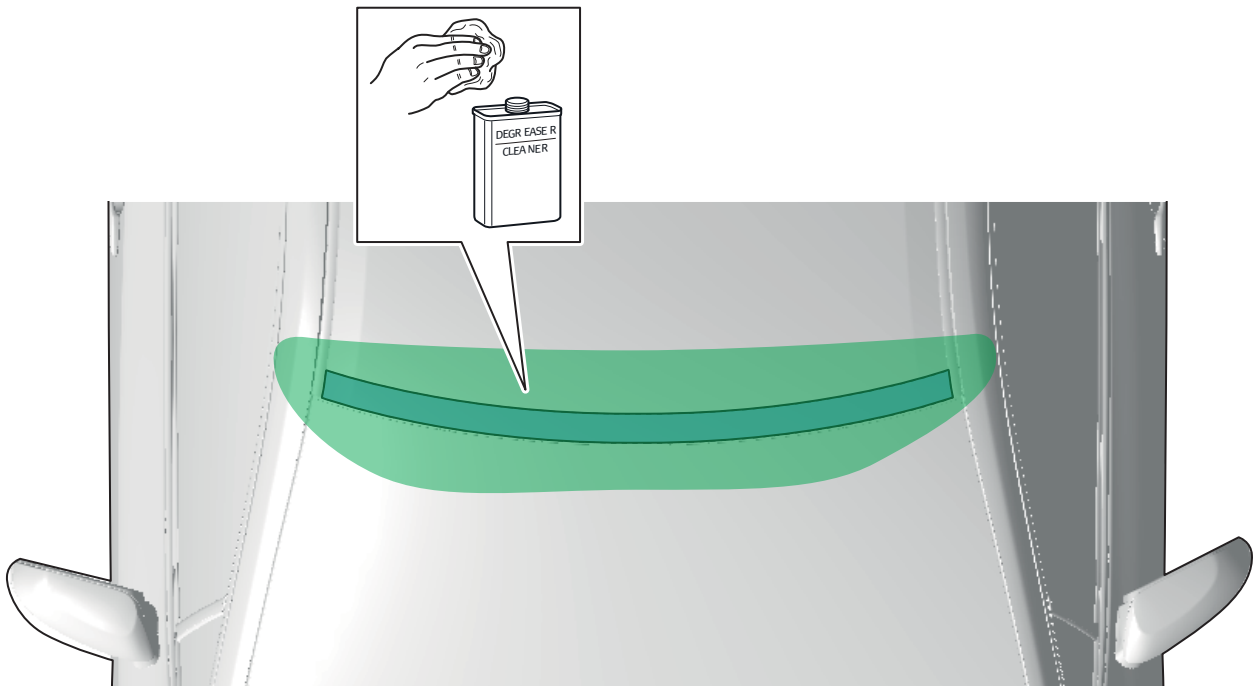

11



**INFO**

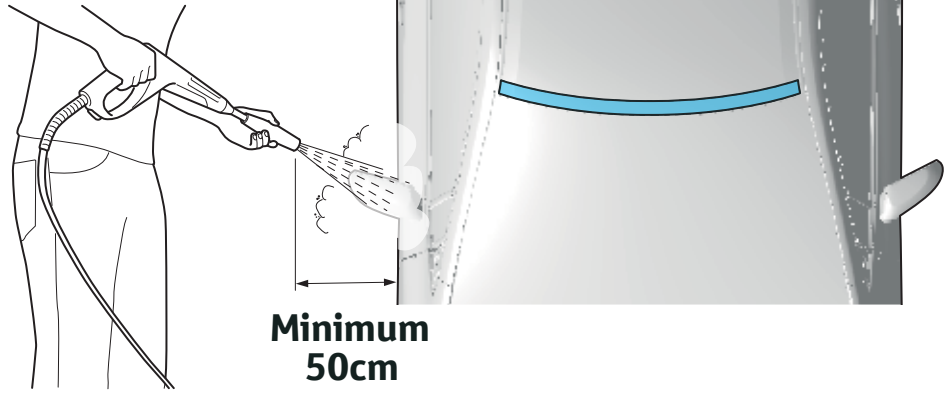
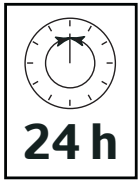
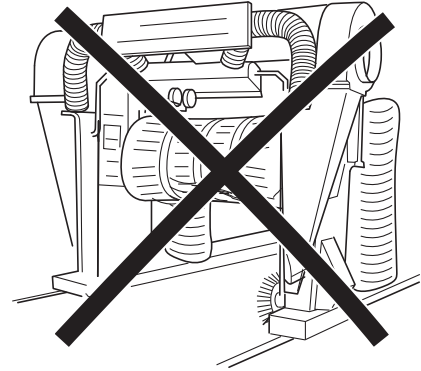
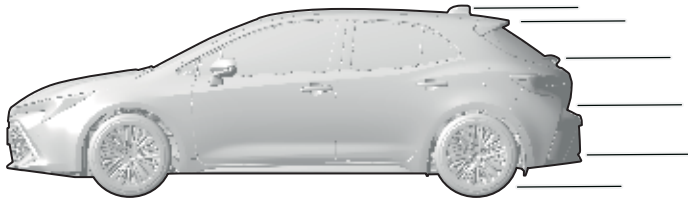
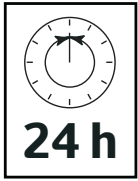



TOYOTA

# CHECK SHEET

Page 1 of 1

Model/Year

Corolla  
As from 2019/05

Roof Protection Film

VIN n°

ALWAYS A  
BETTER WAY

## DURING INSTALLATION

**1**

P/N = OK

**2**

= OK

## AFTER INSTALLATION

**1**

= OK

Installation Date:

. . / . . / . . . .

Technician Name & Signature:

Stamp:

