



TOYOTA

ALWAYS A
BETTER WAY

Auris

Mudflaps

Installation Instructions

Model year: 2012/10, 2015/05

Vehicle code: **E18**-DH***W

Part number: 53008-02010

Manual reference number: AIM 002 666-1

Revision record

| Rev. No. | Date | Page | Picture | Update | New | Deleted steps |
|----------|----------|------|---------|------------|-----|---------------|
| 1 | 15-01-15 | 1+7 | | Model year | | |
| | | | | | | |
| | | | | | | |
| | | | | | | |
| | | | | | | |
| | | | | | | |

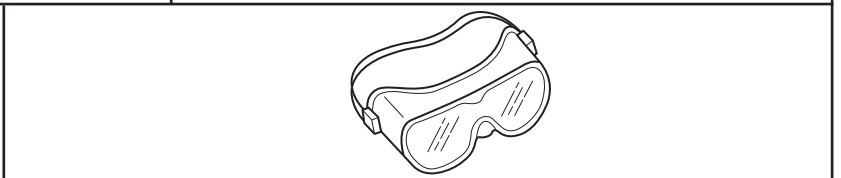
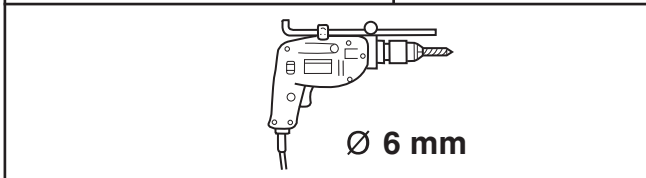
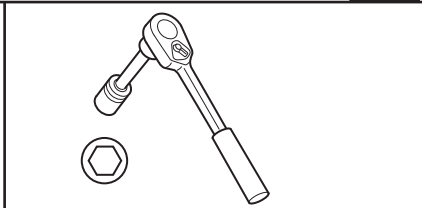
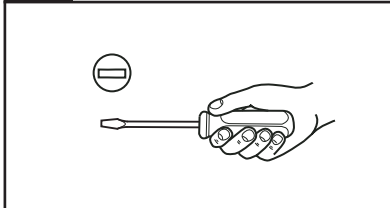
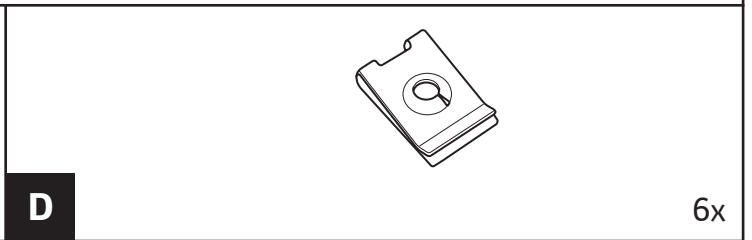
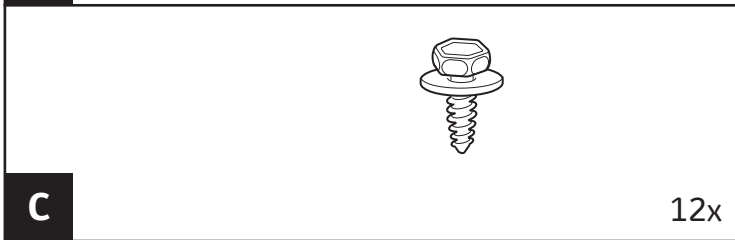
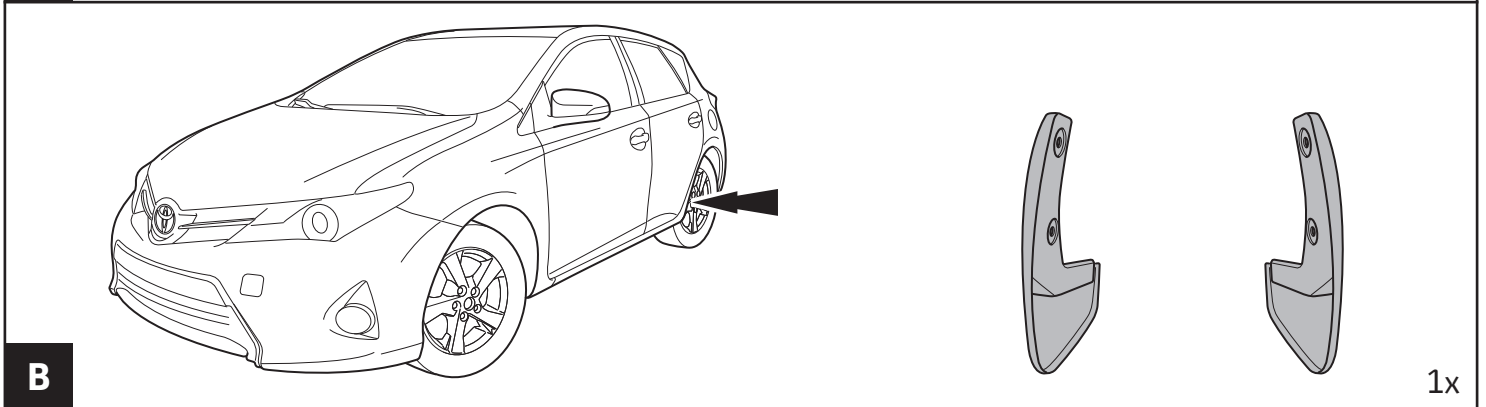
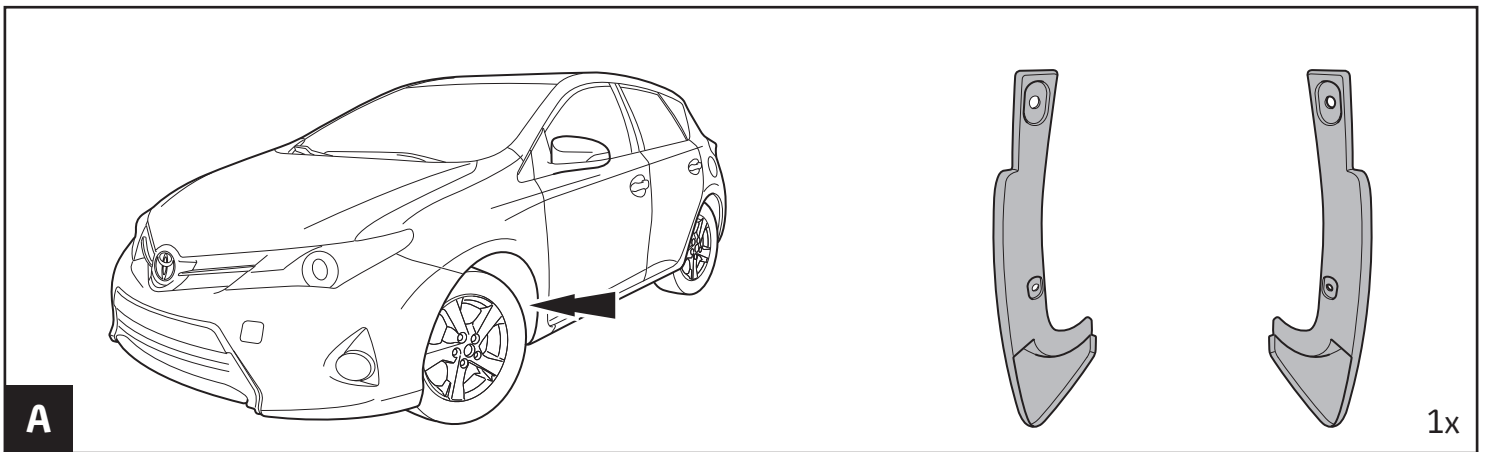

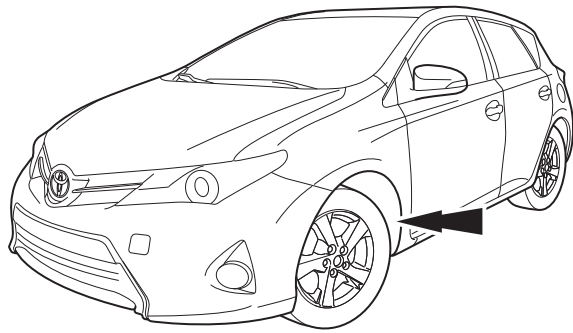
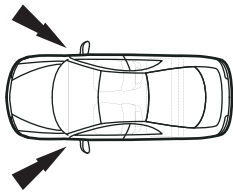

1

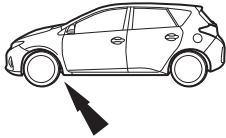
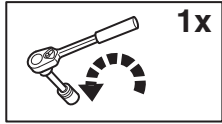

L+R

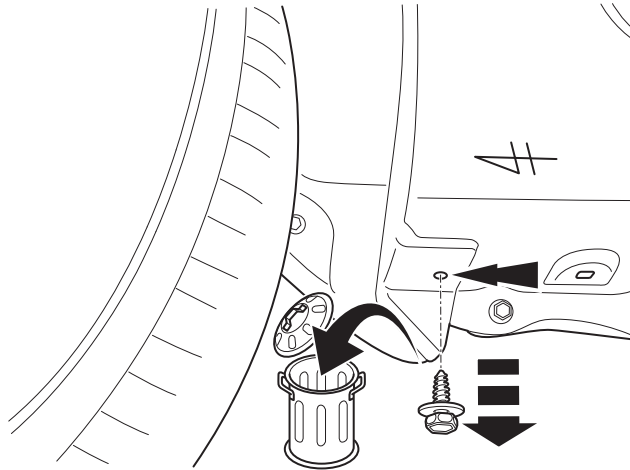

2

L+R

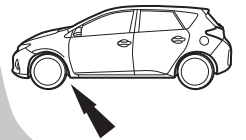
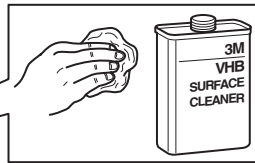

3

L+R

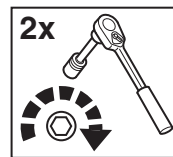
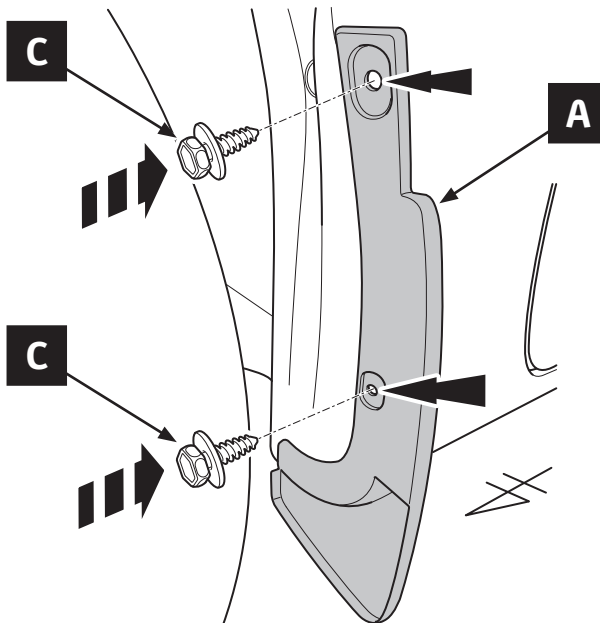

4

L+R

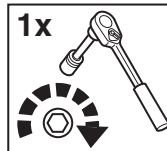

A

C

5

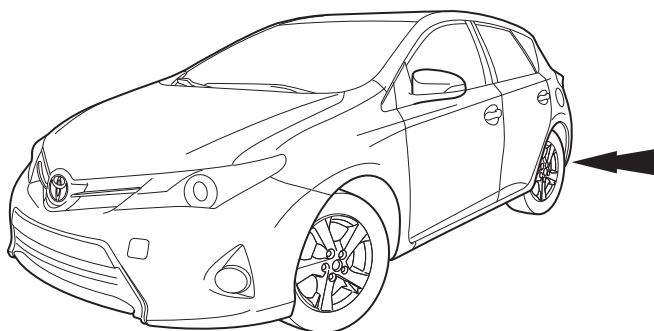
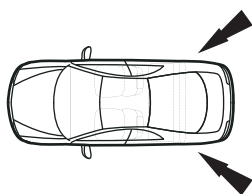

6

L+R



7

L+R

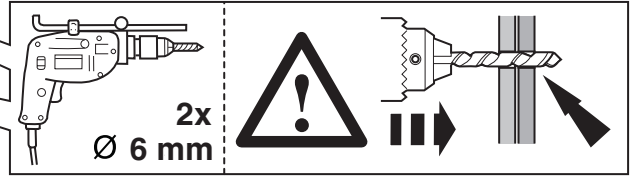
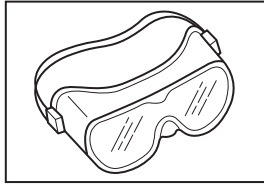

8

L+R

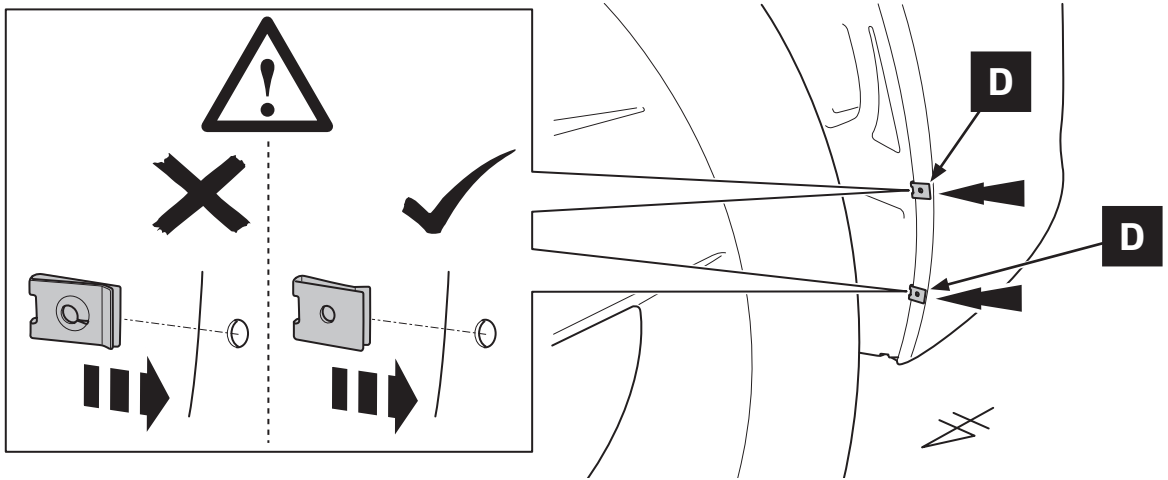

9

L+R

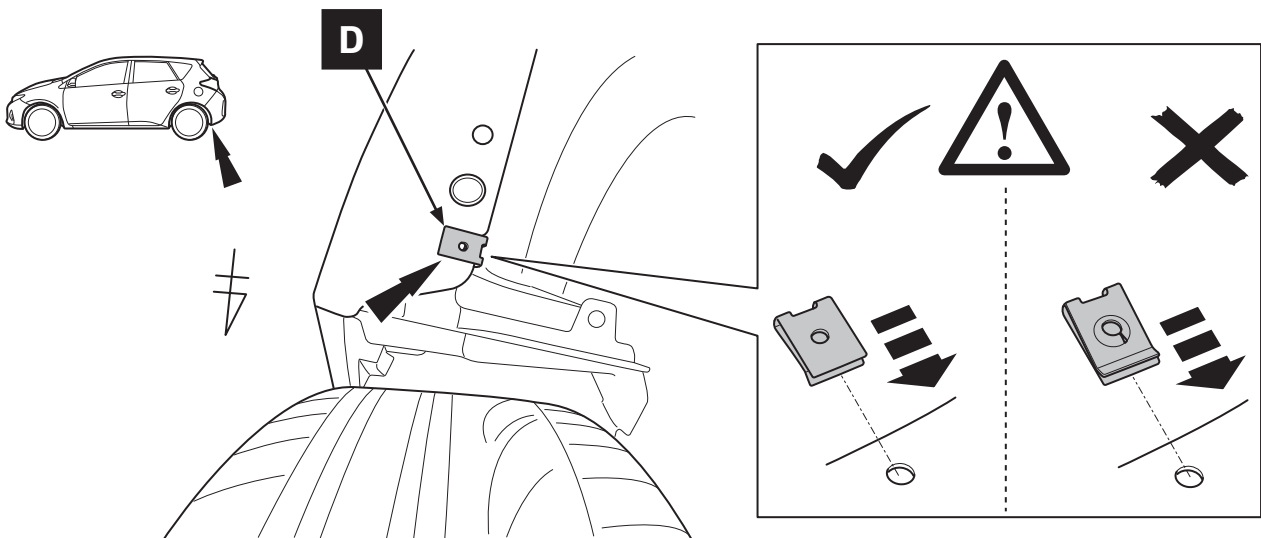

10

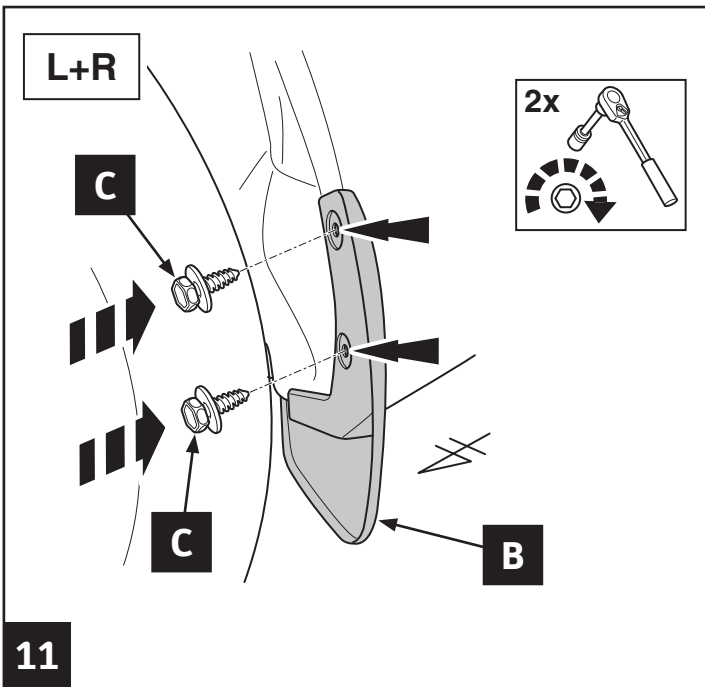

11

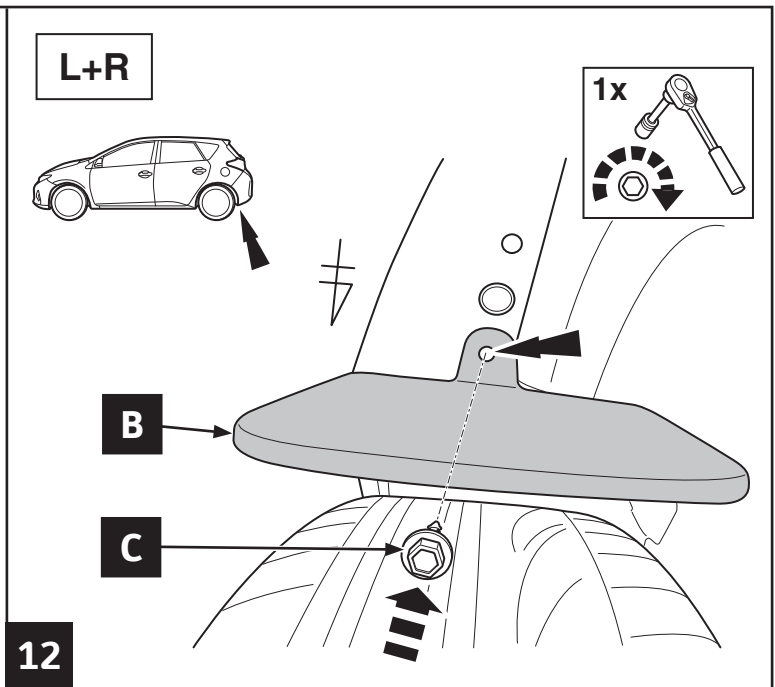

12

CHECK SHEET



TOYOTA

Model / Year **Auris** Mud Flaps - Front & Rear
 2012/10, 2015/05

VIN n°

ALWAYS A BETTER WAY

P/N = OK

LH = RH

LH = RH

= OK

Installation Date:
 . . / . . /

Technician Name & Signature:

Stamp: