



**TOYOTA**

ALWAYS A  
BETTER WAY

# Corolla (TS & 2.0L)

Towbar wiring kit 13-pin

Towbar wiring kit 7-pin

Installation Instructions

Model year:	2019/02	
Vehicle code:	NRE210*-DW**ZW, ZWE211*-DWX*BW, MZEH12*-DWX*BW	
Part number:	PW5D0-02570	13 Pin
	PW5D0-02569	7 Pin

Manual reference number: AIM 006 087-1

# DISCLAIMER

**EN**

- Expert Fitment Required.
- Disconnect the battery earth cable.
- To avoid damage to the wiring harness, ensure contact with sharp edges is prevented.
- Install parts as shown on illustrations.
- Re-connect battery.
- Re-fit panels, ensure that the wiring harness and other components are neatly and securely located.

**ES**

- Montaje sólo por el concesionario.
- Desconectar el cable de masa de la batería.
- A efectos de evitar desperfectos en el aislamiento del cable, hay que evitar el contacto con aristas cortantes.
- Montar las piezas tal como se indica en las figuras.
- Vuelva a conectar la batería.
- Volver a colocar los paneles; preste atención a que el mazo del cable y las demás piezas tengan la posición correcta y precisa.

**IT**

- E' necessario in officina specializzata.
- Staccare il cavo di massa dalla batteria
- Allo scopo di evitare danni all'isolazione dei cavi, evitare di metterli a contatto con spigoli acuti.
- Montare le parti secondo quanto rilevabile delle illustrazioni.
- Riconnettere la batteria.
- Rimettere in posizione i pannelli; far ben attenzione che il fascio di cavi e le altre parti siano state posizionate con esattezza e nella dovuta maniera.

**NL**

- Montage door vakman nodig.
- Massakabel van accu losmaken.
- Ter vermijding van beschadiging van de isolatie van de elektrokit dient contact met scherpe kanten te worden vermeden.
- Delen overeenkomstig afbeelding monteren.
- Accu weer aansluiten.
- Panelen weer monteren; let erop, dat de kabelboom en andere delen correct en netjes gepositioneerd worden.

**NO**

- Nødvendig med montering fra fagvegverksted.
- Klem jordkabelen av batteriet.
- For å unngå skader på kabelisoleringen må berøring av skarpe kanter unngås.
- Monter alle deler i henhold til illustrasjonene.
- Tilkoppl batteriet igjen.
- Monter panelene igjen, og pass på at kabelbunten og andre deler er anbrakt ordentlig og på riktig sted.

**FI**

- Asennus tarpeen merkikorkijaamossa.
- Erotta maadoitusjohto akusta
- Pidä huoli myös siitä, että kaapelointi on korin kiinnityksen myötäinen ja kiinnitetty huolellisesti muihin liikkuviin osiin.
- Asenna osat kuvien mukaan.
- Kytke akku takaisin.
- Aseta paneelit paikalleen; tarkista, että kaapelointi ja muut osat ovat asianmukaisesti ja tarkalleen paikoillaan.

**DE**

- Montage durch Fachwerkstatt erforderlich.
- Massekabel von Batterie abklemmen.
- Zur Vermeidung von Beschädigungen an der Isolierung ist Berührung mit scharfen Kanten zu vermeiden.
- Teile gemäß Abbildung montieren.
- Batterie wieder anschließen.
- Paneele wieder anbringen; achten Sie darauf, dass der Kabelbaum und andere Teile ordnungsgemäß und genau positioniert sind.

**FR**

- Montage par spécialiste nécessaire.
- Débrancher le câble de masse de la batterie.
- Eviter tout contact avec des arêtes vives afin de ne pas endommager l'isolation des câbles.
- Monter les pièces selon les figures.
- Reconnecter la batterie.
- Remettre le panneau; veillez à ce que le faisceau et les autres pièces soient positionnés correctement et avec la précision requise.

**PT**

- Especialista em montagem requerido.
- Separe o cabo de terra do acumulador.
- Para não se danificar a isolação dos cabos, é conveniente evitar-se contacto com arestas afiadas.
- Monte as partes conforme ilustrado.
- Recolocar a bateria
- Tornar a colocar os painéis; verificar se a árvore de cabos e outras peças estão na posição exacta e prescrita.

**DA**

- Montage ved professionelt værksted påkrævet.
- Stelkabel fjernes fra batteri.
- Berøring med skarpe kanter skal undgås for at undgå beskadigelse af kabelisoleringen.
- Dele skal monteres i henhold til illustrationer.
- Tilslut batteri igen.
- Paneler fastgøres igen; vær opmærksom på, at kabelsamlingen og andre dele placeres korrekt og præcist.

**SV**

- Verkstadsmontage erfordras.
- Lossa stomkabeln från batteriet.
- För att förhindra skador på ledningarnas isolation skall berøring med vassa kanter undvikas.
- Montera detaljerna enligt figurerna
- Anslut batteriet igen.
- Sätt tillbaka panelerna igen; kontrollera noga att ledningsmattan och andra detaljer ligger på rätt plats.

**CS**

- Montáž ve specializované dílně nutná.
- Odpojte zemnicí kabel od baterie.
- Zabraňte tomu, aby se kabely poškodily tím, že jsou položeny na ostrých hranách.
- Montujte části podle vyobrazení
- Opět připojte baterii.
- Opět připevněte panely; dbejte na to, aby svazek kabelů a ostatní části byly uloženy na správném místě.

# DISCLAIMER

**HU**

- A szereléshez szakműhely kell.
- Húzza le az akkumulátor testkábéljét.
- A kábelbiztosítás megsérülésének elkerülésére ügyeljen arra, hogy a kábel ne juthasson érintkezésbe éles peremű alkatrészekkel.
- Az alkatrészeket az ábrák szerint szerelje be.
- Ismét csatlakoztassa az akkumulátort.
- Szerelje vissza a fedőlapokat, ügyeljen arra, hogy a ábelek és a többi alkatrészek pontosan a számukra kijelölt helyen maradjanak.

**EL**

- Η τοποθέτηση να γίνει MONO από εξουσιοδοτημένο συνεργείο
- Αποσυνδέστε το καλώδιο της γείωσης από την μπαταρία
- Για να αποφευχθούν φθορές στη μόνωση των καλωδίων, βεβαιωθείτε ότι αυτά δεν έρχονται σε επαφή με αιχμηρά σημεία
- Τοποθετήστε τα εξαρτήματα σύμφωνα με τα σχέδια
- Συνδέστε πάλι την μπαταρία
- Τοποθετήστε πάλι τα διάφορα πλαίσια – ΠΡΟΣΟΧΗ: η πλεξούδα καθώς και τα υπόλοιπα εξαρτήματα να τοποθετηθούν οργανωμένα, με ασφάλεια και σύμφωνα με τους κανονισμούς

**TR**

- Uzmanın takması gereklidir.
- Akü toprak kablosunu ayırın.
- Kablo demetinin hasar görmemesi için, sivri objelerle temasın engellenmesini sağlayın.
- Parçaları çizimlerde gösterildiği gibi takın.
- Aküyü tekrar bağlayın.
- Panoları tekrar takın, kablo demeti ve diğer komponentlerin tam ve sıkıca yerleşmesini sağlayın.

**ET**

- Paigaldada spetsialisti poolt.
- Võtke massikaabel aku küljest lahti.
- Juhtmestiku kahjustamise vältimiseks hoidke juhtmed eemal teravatest servadest.
- Paigaldage osad vastavalt joonistele.
- Ühendage aku.
- Paigaldage kattepaneelid; veenduge, et juhtmestik ja muud osad on paigutatud korrektselt ning kindlalt.

**LT**

- Būtina, kad sumontuotų specialistas.
- Atjunkite akumulatoriaus įžeminimo laidą.
- Tam, kad išvengtumėte įvado apgadinimo, saugokite, kad laidai nesiliestų prie aštrių briaunų.
- Sumontuokite dalis taip, kaip pavaizduota iliustracijoje.
- Prijunkite akumuliatorių.
- Į vietas įdėkite skydelius, patikrinkite, ar laidų šarvai ir kiti komponentai yra savo vietose ir gerai pritvirtinti.

**SL**

- Potrebna je strokovna montaža.
- Odklopite ozemljitveni kabel akumulatorja.
- Da preprečite poškodbe kablskega snopa, preprečite stik z ostrimi robovi.
- Dele namestite, kot je prikazano na slikah.
- Ponovno priklonite akumulator.
- Ponovno montirajte panele in zagotovite, da so kablски snop in druge komponente nameščene varno.

**PL**

- Konieczny montaż przez warsztat specjalistyczny.
- Odłączyć przewód masy od akumulatora.
- Dla zapobieżenia uszkodzeniu izolacji chronić przed zetknięciem z ostrymi krawędziami.
- Zamontować części zgodnie z rysunkiem.
- Ponownie podłączyć akumulator.
- Na powrót osadzić osłony; zadbać aby wiązka kablowa i inne części były właściwie i dokładnie ułożone.

**RU**

- Монтаж должны выполнять специалисты в мастерской
- Отсоединить заземляющий кабель аккумулятора
- Во избежание повреждений изоляции кабеля не допускать соприкосновения с острыми углами
- Монтировать части согласно иллюстрации
- Снова подключить аккумулятор
- Установить панель, проверить правильность и точность расположения кабелей и других частей.

**BG**

- Изисква се поставяне от специалист.
- Откачете заземляващия кабел на акумулатора.
- За избягване на повреди по кабелния сноп се уверете, че няма контакт с остри ръбове.
- Монтирайте частите според показаното на илюстрацията.
- Свържете отново акумулатора.
- Поставете отново панелите, уверете се, че кабелният сноп и останалите компоненти са разположени подредено и надеждно.

**LV**

- Nepieciešami īpaši saliekamie elementi.
- Atvienojiet akumulatora zemējuma vadu.
- Lai nesabojātu elektroinstalāciju, nepieskarieties tai ar asiem priekšmetiem.
- Uzstādiet detaļas, kā parādīts attēlos.
- Pievienojiet akumulatoru.
- Uzlieciet paneļus, raugieties, lai elektroinstalācija un citas daļas būtu kārtīgi un stingri nofiksētas.

**RO**

- Este necesară instalarea de către un specialist.
- Deconectați cablul de împământare a bateriei.
- Pentru a evita deteriorarea cablajului, evitați contactul cu muchiile ascuțite.
- Montați componentele așa cum este prezentat în figuri.
- Reconectați bateria
- Reinstalați panourile, aveți grijă de plasarea îngrijită și în condiții de siguranță a cablajului și a celorlalte componente.

**SK**

- Vyžaduje sa profesionálne vybavenie.
- Odpojte zemniaci vodič akumulátora.
- Káblové zväzky sa nesmú dotýkať ostrých okrajov, aby sa nepoškodili.
- Dielce založte tak, ako je znázornené na obrázkoch.
- Znovu zapojte akumulátor.
- Založte panely a uistite sa, že káblové zväzky a iné dielce sú bezpečne a prehľadne uložené.

# WIRE COLOUR TABLE

	EN	DE	ES	FR	IT	PT	NL	DA	NO	SV	FI	CS
<b>L</b>	Blue	Blau	Azul	Bleu	Blu	Azul	Blauw	Blå	Blå	Blå	Sininen	Modrá
<b>B</b>	Black	Schwarz	Negro	Noir	Nero	Preto	Zwart	Sort	Sort	Svart	Musta	Černá
<b>BR</b>	Brown	Braun	Marrón	Marron	Marrone	Castanho	Bruin	Brun	Brun	Brun	Ruskea	Hnědá
<b>DL</b>	Dark blue	Dunkelblau	Azul oscuro	Bleu foncé	Blu scuro	Azul-escuro	Donkerblauw	Mørkeblå	Mørkeblå	Mörkblå	Tummansininen	Tmavomodrá
<b>DG</b>	Dark green	Dunkelgrün	Verde oscuro	Vert foncé	Verde scuro	Verde-escuro	Donker-groen	Mørkegrøn	Mørkegrønn	Mörkgrön	Tummanvihreä	Tmavozelená
<b>G</b>	Green	Grün	Verde	Vert	Verde	Verde	Groen	Grøn	Grønn	Grön	Vihreä	Zelená
<b>GR</b>	Grey	Grau	Gris	Gris	Grigio	Cinzeno	Grijs	Grå	Grå	Grå	Harmaa	Šedá
<b>LB</b>	Light blue	Hellblau	Azul claro	Bleu clair	Blu chiaro	Azul-claro	Lichtblauw	Lyseblå	Lyseblå	Ljusblå	Vaaleansininen	Bleděmodrá
<b>LG</b>	Light green	Hellgrün	Verde claro	Vert clair	Verde chiaro	Verde-claro	Lichtgroen	Lysegrøn	Lysegrønn	Ljusgrön	Vaaleanvihreä	Světlezelená
<b>NO</b>	Natural colour	Naturfarben	Color natural	Nature	Colori naturali	Cores naturais	Naturel	Naturfarvet	Naturfarger	Naturfärger	Luonnonväri	Přírodní barva
<b>O</b>	Orange	Orange	Naranja	Orange	Arancione	Laranja	Oranje	Orange	Orange	Orange	Oranssi	Oranžová
<b>P</b>	Pink	Rosa	Rosa	Rose	Rosa	Rosa	Rosé	Rosa	Rosa	Rosa	Rosa	Růžová
<b>R</b>	Red	Rot	Rojo	Rouge	Rosso	Vermelho	Rood	Rød	Rød	Röd	Punainen	Červená
<b>PU</b>	Purple	Purpur	Púrpura	Pourpre	Rosso porpora	Púrpura	Paars	Purpur	Purpur	Purpur	Purppura	Purpurová
<b>SB</b>	Sky blue	Himmelblau	Azul cielo	Bleu ciel	Celeste	Azul-céu	Hemelsblauw	Himmelblå	Himmelblå	Himmelsblå	Taivaansininen	Blankytná
<b>T</b>	Yellow brown	Gelbbraun	Amarillo-marrón	Marron-jaune	Giallomarrone	Castanho-amarelado	Geelbruin	Gulbrun	Gulbrun	Gulbrun	Keltaisenruskea	Žlutohnědá
<b>W</b>	White	Weiß	Blanco	Blanc	Bianco	Branco	Wit	Hvid	Hvit	Vit	Valkoinen	Bílá
<b>Y</b>	Yellow	Gelb	Amarillo	Jaune	Giallo	Amarelo	Geel	Gul	Gul	Gul	Keltainen	Žlutá
<b>V</b>	Violet	Violett	Violeta	Violet	Viola	Violeta	Violet	Violet	Fiolett	Violett	Violett	Fialová

	HU	PL	EL	RU	TR	BG	ET	LV	LT	RO	SL	SK
<b>L</b>	Kék	Niebieska	Μπλε	Синий	Mavi	Синьо	Sinine	Zils	Mėlyna	Albastru	Modra	Modrá
<b>B</b>	Fekete	Czarna	Μαύρο	Чёрный	Siyah	Черно	Must	Melns	Juoda	Negru	Črna	Čierna
<b>BR</b>	Barna	Brazowa	Καφέ	Коричневый	Kahverengi	Καφάβο	Pruun	Brūns	Ruda	Maro	Rjava	Hnedá
<b>DL</b>	Sötétkék	Granatowa	Σκούρο Μπλε	Тёмно-синий	Koyu mavi	Тъмносиньо	Tume-sinine	Tumši zils	Tamsiai mėlyna	Albastru inchis	Temno modra	Tmavomodrá
<b>DG</b>	Sötétzöld	Ciemnozielona	Σκούρο Πράσινο	Тёмно-зелёный	Koyu yesil	Тъмноезелено	Tumeroheline	Tumši zaļš	Tamsiai žalia	Verde inchis	Temno zelena	Tmavozelená
<b>G</b>	Zöld	Zielona	Πράσινο	Зелёный	Yeşil	Зелено	Roheline	Zaļš	Žalia	Verde	Zelena	Zelená
<b>GR</b>	Szürke	Szara	Γκρι	Серый	Gri	Сиво	Hall	Pelėks	Pilka	Gri	Siva	Sivá
<b>LB</b>	Világoskék	Jasniebieska	Ανοχτό Μπλε	Голубой	Acik mavi	Светлосиньо	Helesinine	Gaiši zils	Šviesiai mėlyna	Albastru deschis	Svetlo modra	Svetlomodrá
<b>LG</b>	Világoszöld	Jasnozielona	Ανοχτό Πράσινο	Светло-зелёный	Acik yesil	Светлозелено	Heleroheline	Gaiši zaļš	Šviesiai žalia	Verde deschis	Svetlo zelena	Svetlozelená
<b>NO</b>	Természetes színű	Barwy naturalne	Φυσικό Χρώμα	Телесный	Nötr	Естествен цвят	Vārvtu	Dabiska krāsa	Natūrali spalva	Culoare naturală	Naravna barva	Přírodní farba
<b>O</b>	Narancs	Pomarańczowa	Πορτοκαλί	Оранжевый	Turuncu	Оранжево	Oranž	Oranžs	Oranžinė	Portocaliu	Oranžna	Oranžová
<b>P</b>	Rózsaszín	Różowa	Ροζ	Розовый	Pembe	Розово	Roosa	Rozā	Rožinė	Roz	Roza	Růžová
<b>R</b>	Piros	Czerwona	Κόκκινο	Красный	Kırmızı	Червено	Punane	Sarkans	Raudona	Roșu	Rdeča	Červená
<b>PU</b>	Biborvörös	Purpurowa	Πορφυρό	Пурпурный	Mor	Пурпурно	Tumerupane	Purpursarkans	Purpurinė	Mov	Škrlatna	Purpurová
<b>SB</b>	Égszínkék	Bękitna	Γαλάζιο	Небесно-голубой	Gök mavisi	Небесносиньо	Taevasinine	Debeszils	Žydra	Azuriu	Nebesno modra	Azürová
<b>T</b>	Sárgásbarna	Żółto-brązowa	Κτρινοκαφέ	Жёлто-коричневый	Sarı kahverengi	Жълтокафяво	Kollanepruun	Dzeltenbrūns	Gelsvai ruda	Galben-maró	Rumeno java	Žltohnědá
<b>W</b>	Fehér	Biała	Λευκό	Белый	Beyaz	Бяло	Valge	Balts	Balta	Alb	Bela	Biela
<b>Y</b>	Sárga	Żółta	Κίτρινο	Жёлтый	Sarı	Жълто	Kollane	Dzeltens	Geltona	Galben	Rumena	Žltá
<b>V</b>	Ibolyakék	Fioletowa	Μωβ	Фиолетовый	Menekşe	Виолетово	Lilla	Violetš	Violetinė	Violet	Vijolična	Fialová



# PW5D0-02570 (13 Pin)

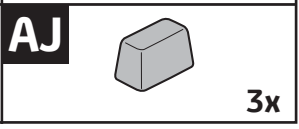
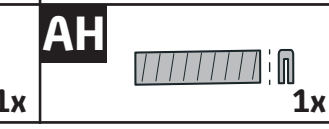
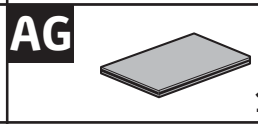
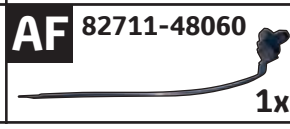
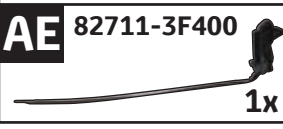
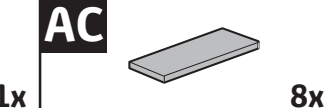
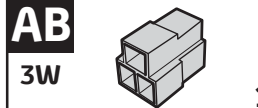
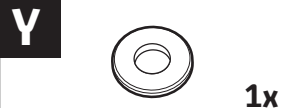
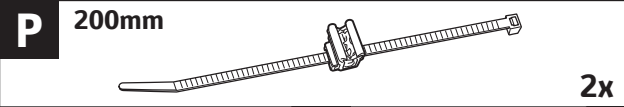
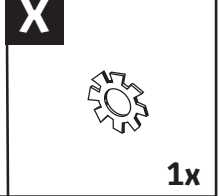
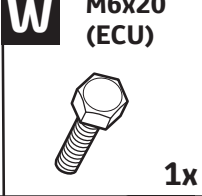
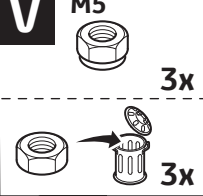
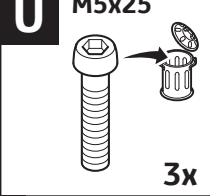
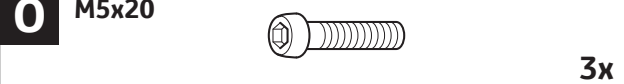
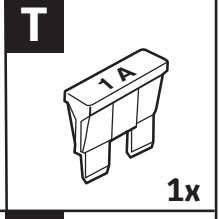
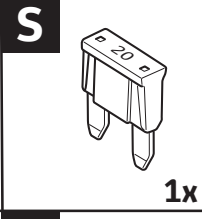
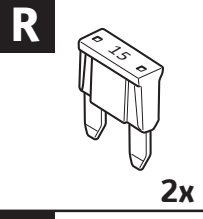
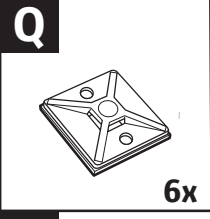
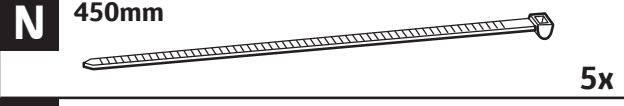
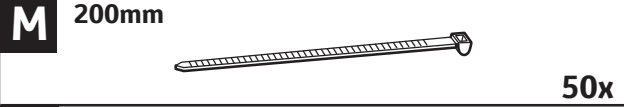
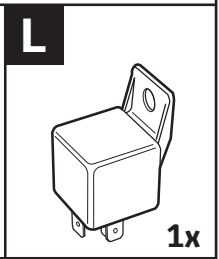
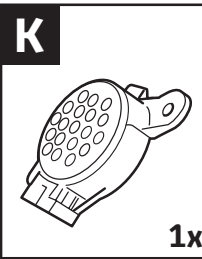
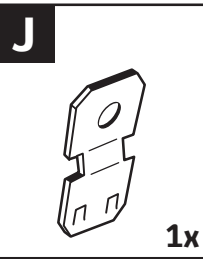
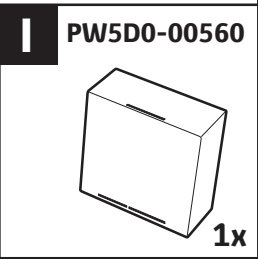
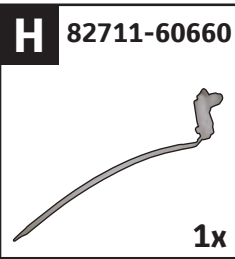
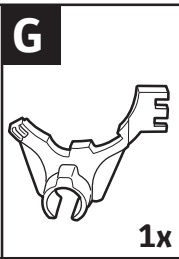
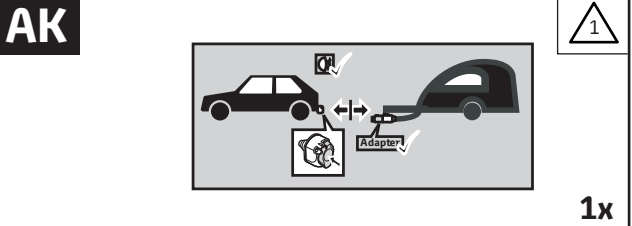
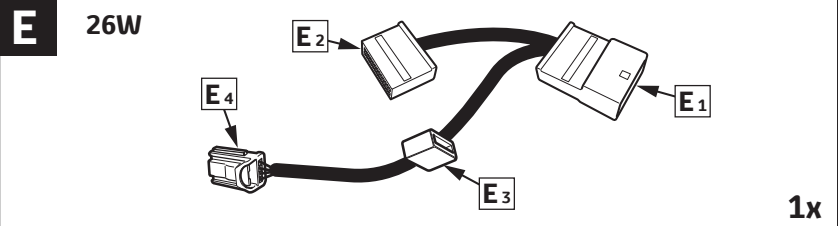
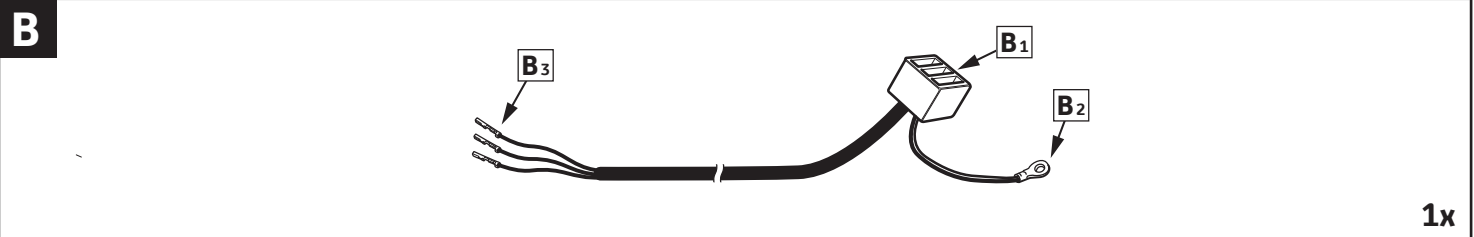
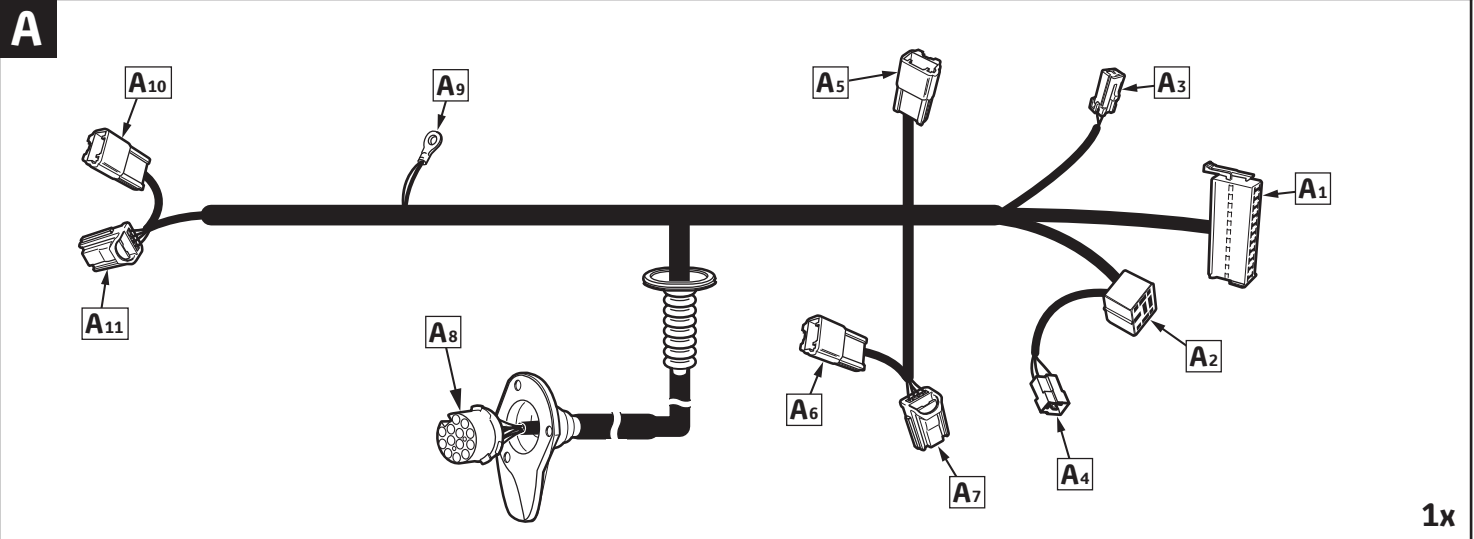

# PW5D0-02569 (7 Pin)

**A**

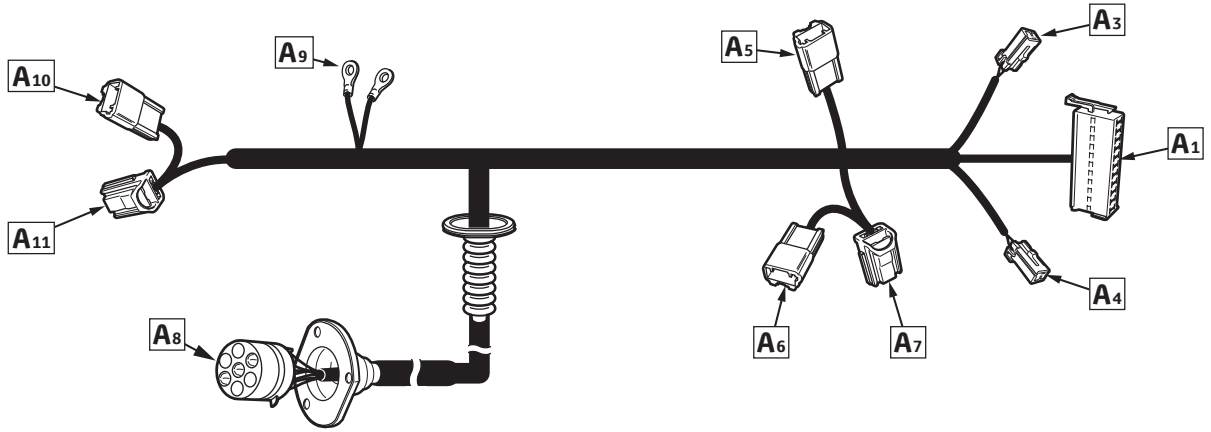

**B**

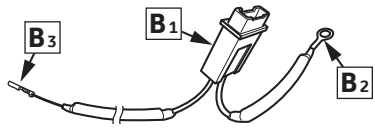

1x

**E**

26W

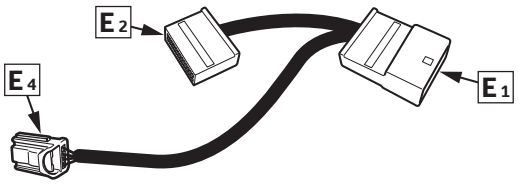

1x

**AK**

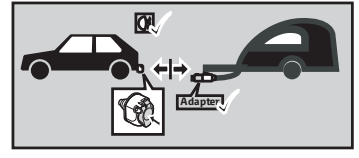

1x

**F**



1x

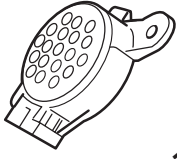

1x

M5x25

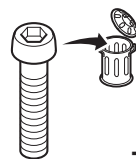

3x

M5



3x



3x

**I**

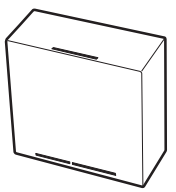

PW5D0-00560 1x

**AC**

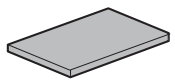

8x

**Y**



1x

**J**



1x

**W**



1x

**Z**



1x

**X**



1x

**O**

M5x20

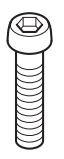

3x

**AB**

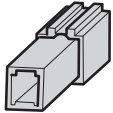

1x

**AJ**



1x

**Q**

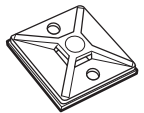

6x

**S**

20A

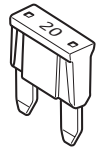

1x

**M**

200mm



50x

**N**

450mm



5x

**P**

200mm

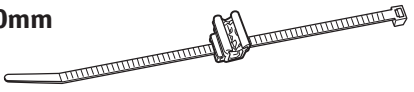

2x

**O**

540mm



4x

**AF**

82711-48060



1x

**AE**

82711-3F400



1x

**H**

82711-60660



1x

**AG**

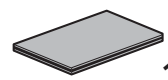











1x

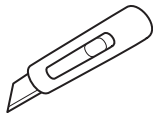
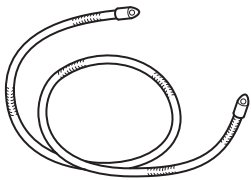
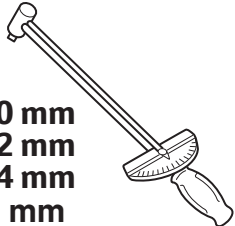
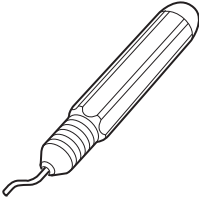

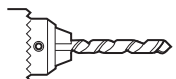
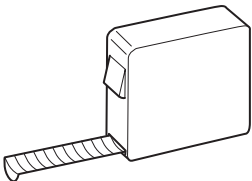
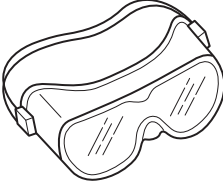

**AD**

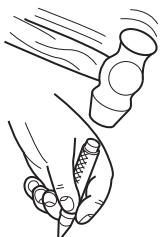

M6x16 (EARTH)

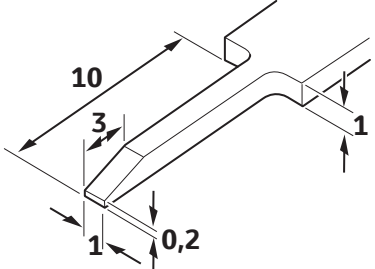
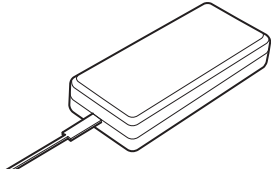

1x

 <p>10 mm 12 mm 14 mm</p>			
 <p>10 mm 12 mm 14 mm 4 mm</p>			
 <p>Ø 2 mm Ø 35 mm</p>			 <p>Soap</p>
 <p>PVC - Tape</p>	 <p>Masking - Tape</p>		 <p>MIN. 500 LUX</p>

 <p><b>A:PRIMER</b> <b>B:ACTIVATOR</b></p> <p>A: Dupont® refinish etching primer B: Dupont® refinish activator</p> <p>or</p> <p>A: Stadox® Etching Adhesion Primer 020 16167 B: Stadox® Etching Adhesion Activator 020 16168</p> <p>or</p> <p>A: Sikken® primer surfacer EP II B: Sikken® primer surfacer EP II Hardener</p>	 <p>CAVITY WAX</p>   <p>DEGREASER CLEANER</p> <p>AIM 003-516-*</p>	<p><b>Reference:</b></p>  <p>10 3 1 1 0,2</p> <p>(mm) PZ415-0JGB9-00</p> 
--	---	--

<h1 style="text-align: center;">INFORMATION</h1>	
  <p><b>Material Safety Data Sheet</b></p>	 <p><b>Technical Data Sheet</b></p>



# WIRE HARNESS OVERVIEW

2.0

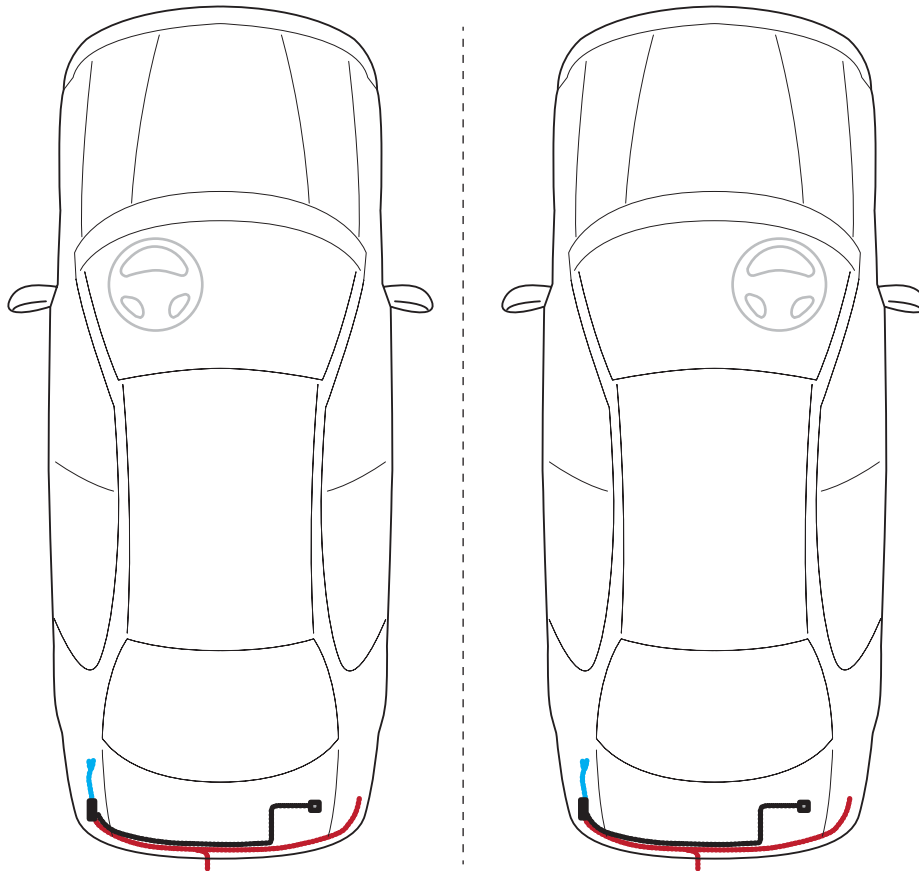

=  XX mm	=	=
=  XX mm	=	=
=	=	=
=  TXX	=	= START

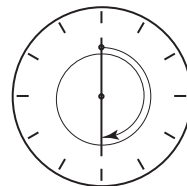
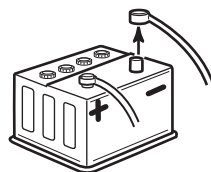
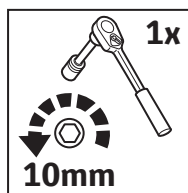

1

○ = 9x 

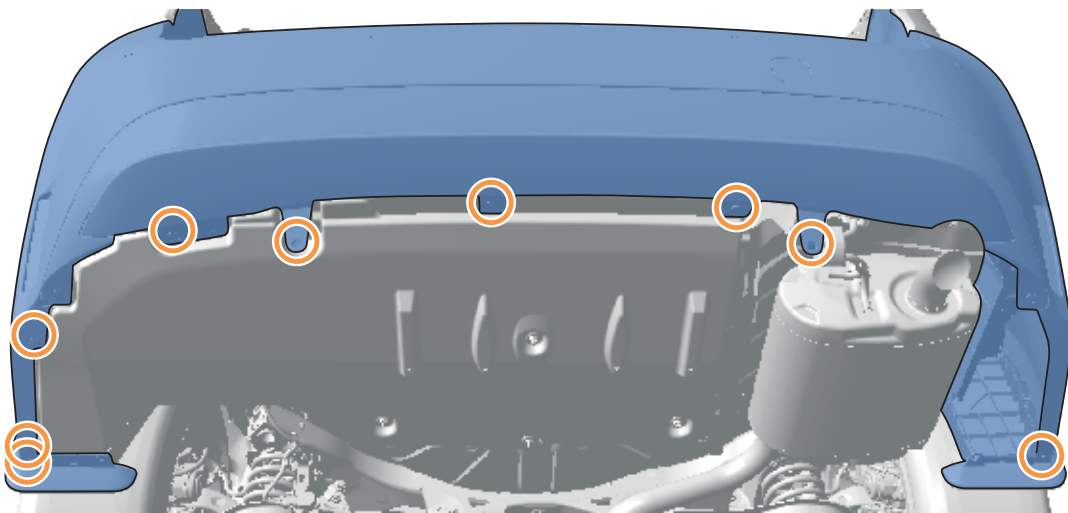

2

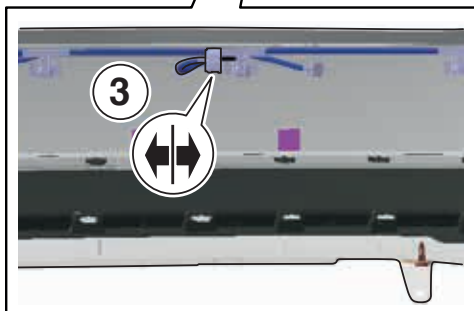
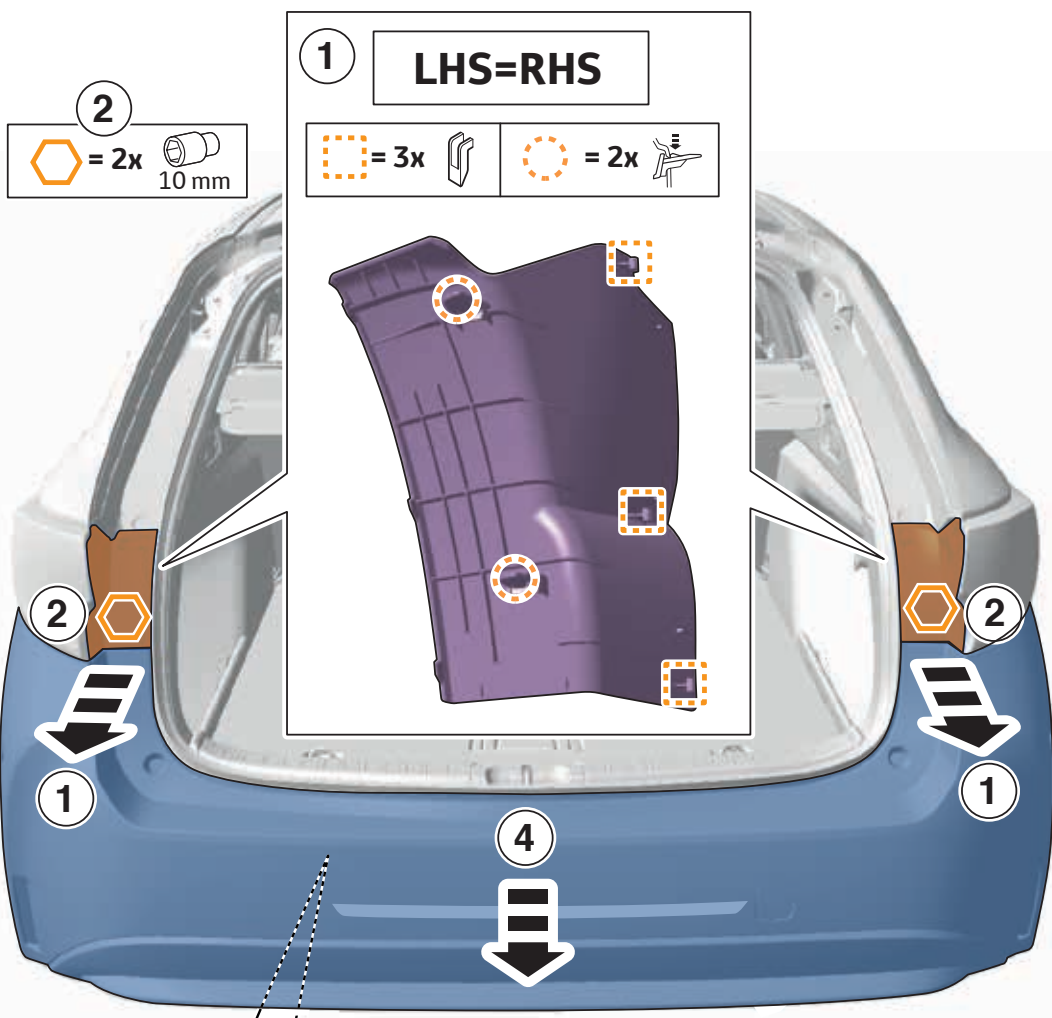

3

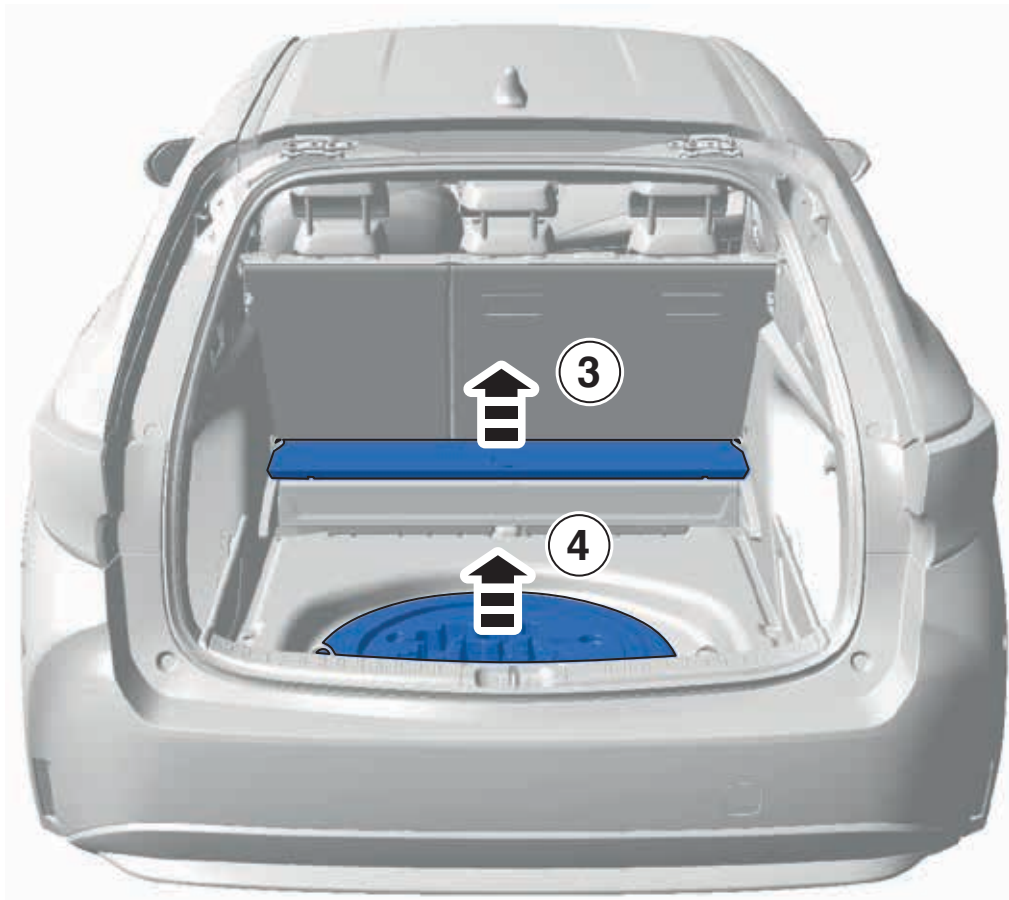

4

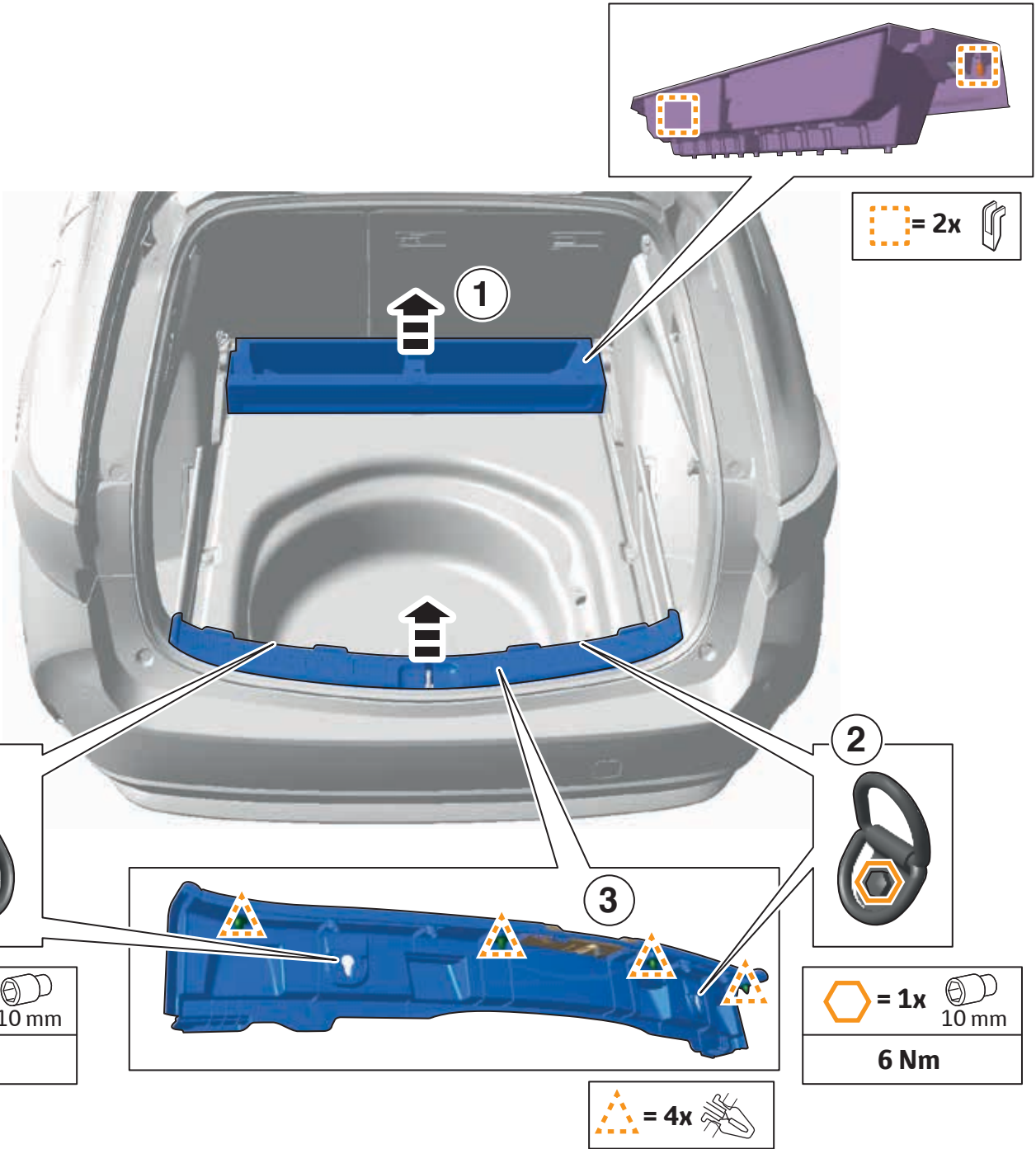

5

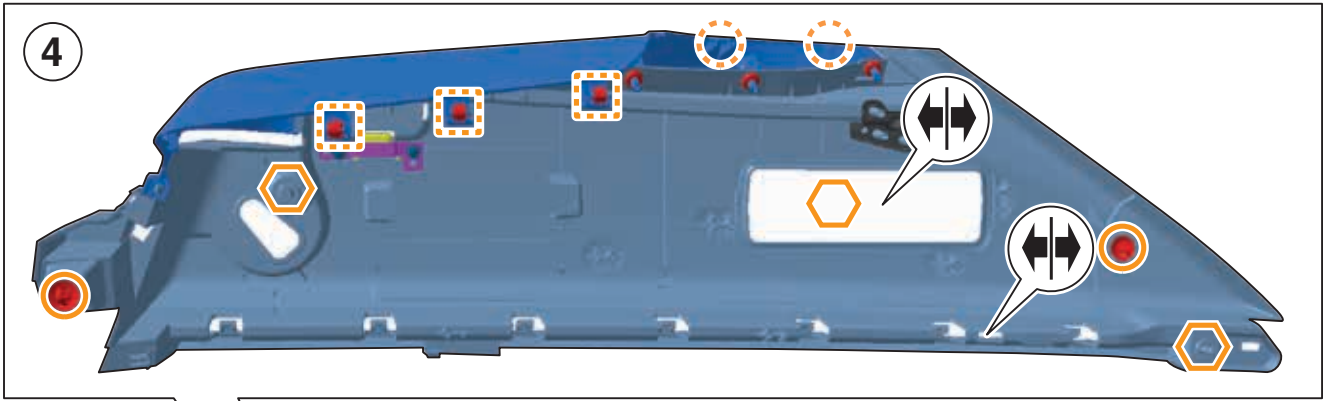

= 3x	= 2x	= 3x	= 2x
------	------	------	------

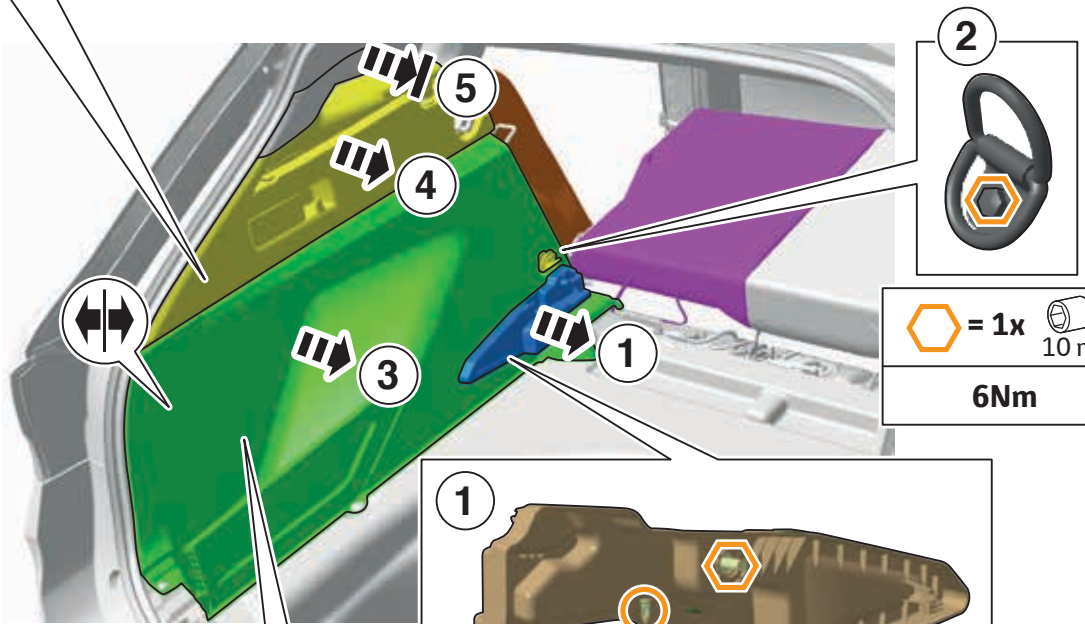

= 1x
<b>6Nm</b>

= 1x	= 1x
------	------

**LHS=RHS**

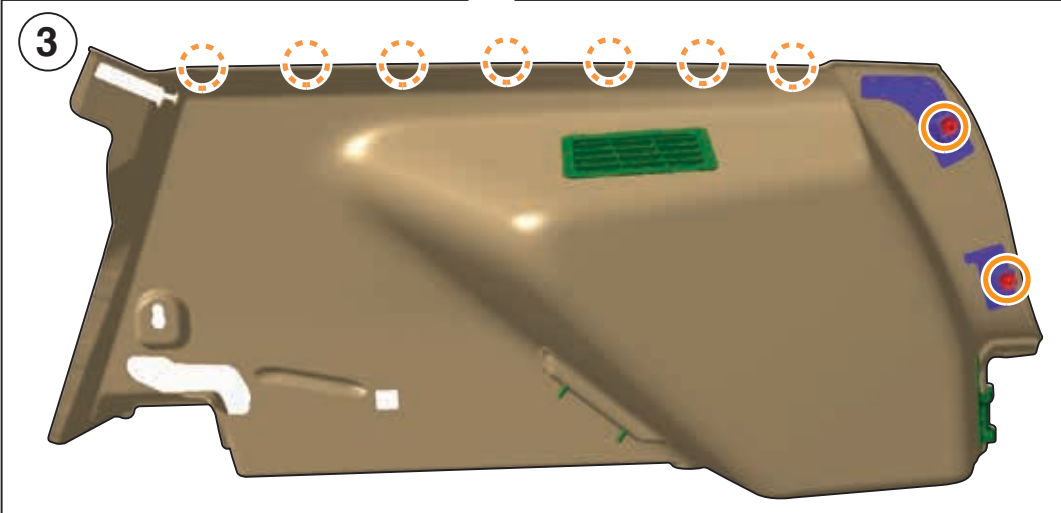

= 7x	= 2x
------	------

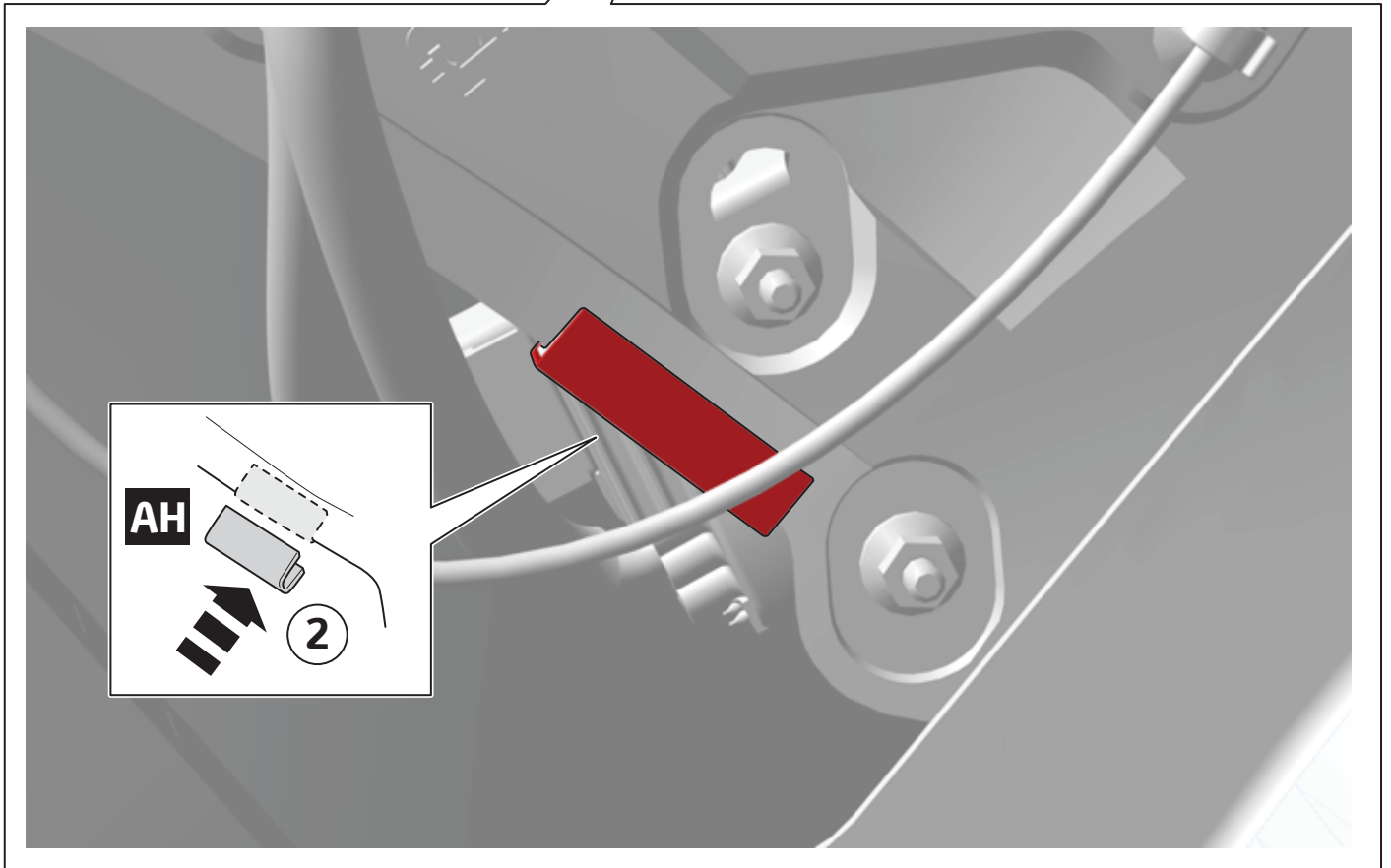
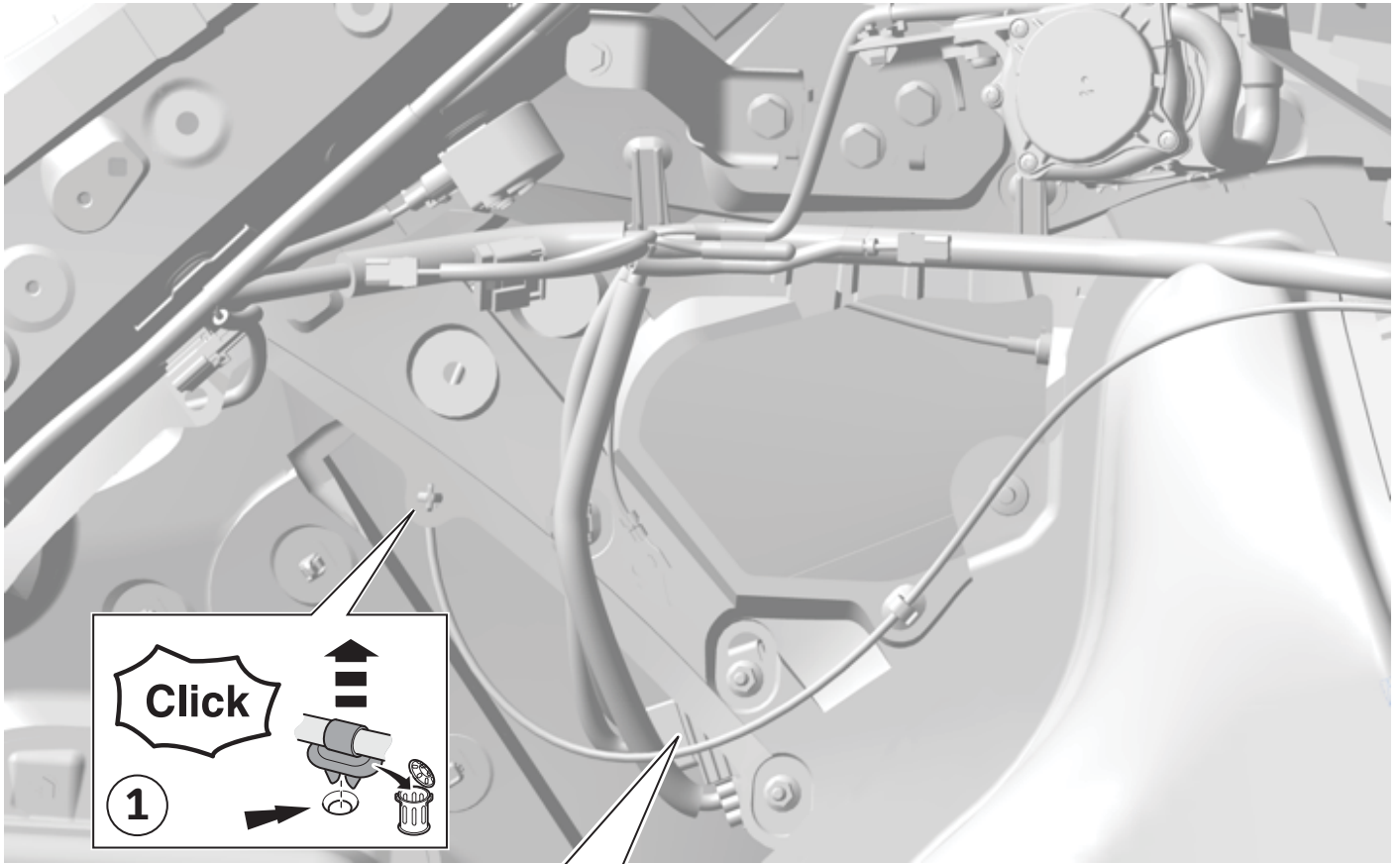

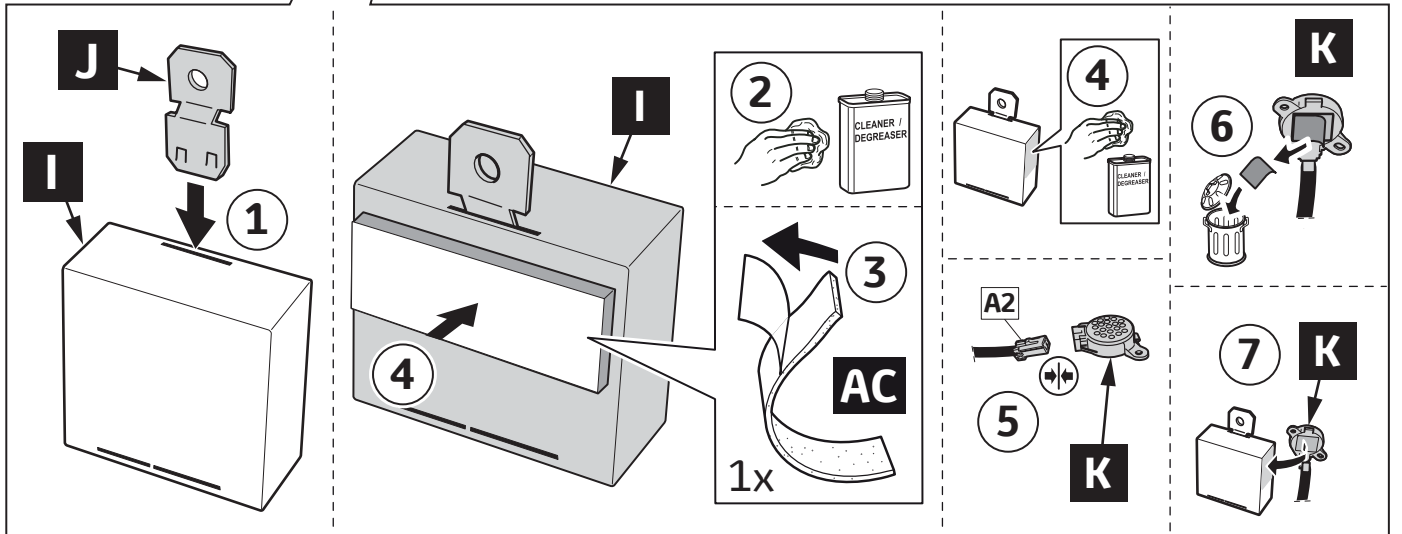
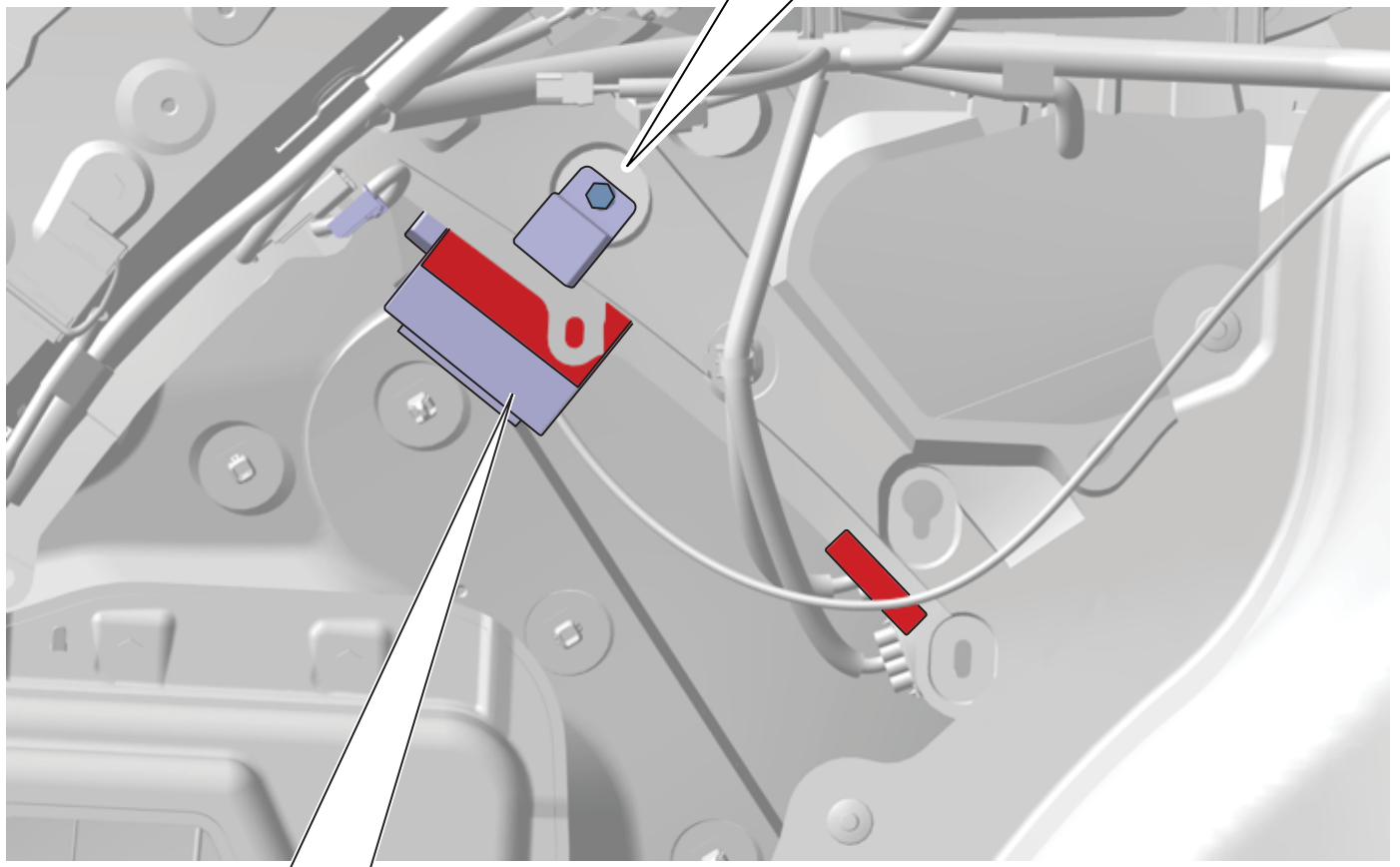
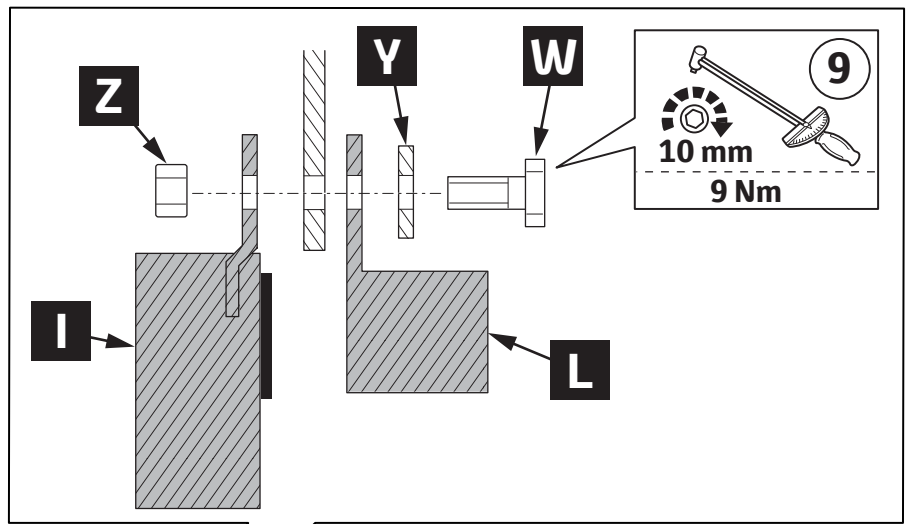
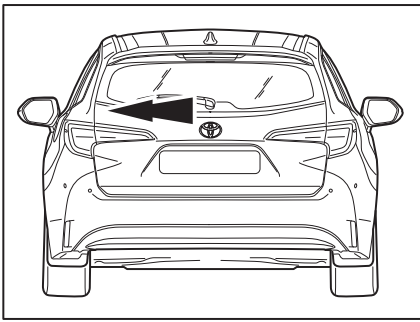

8

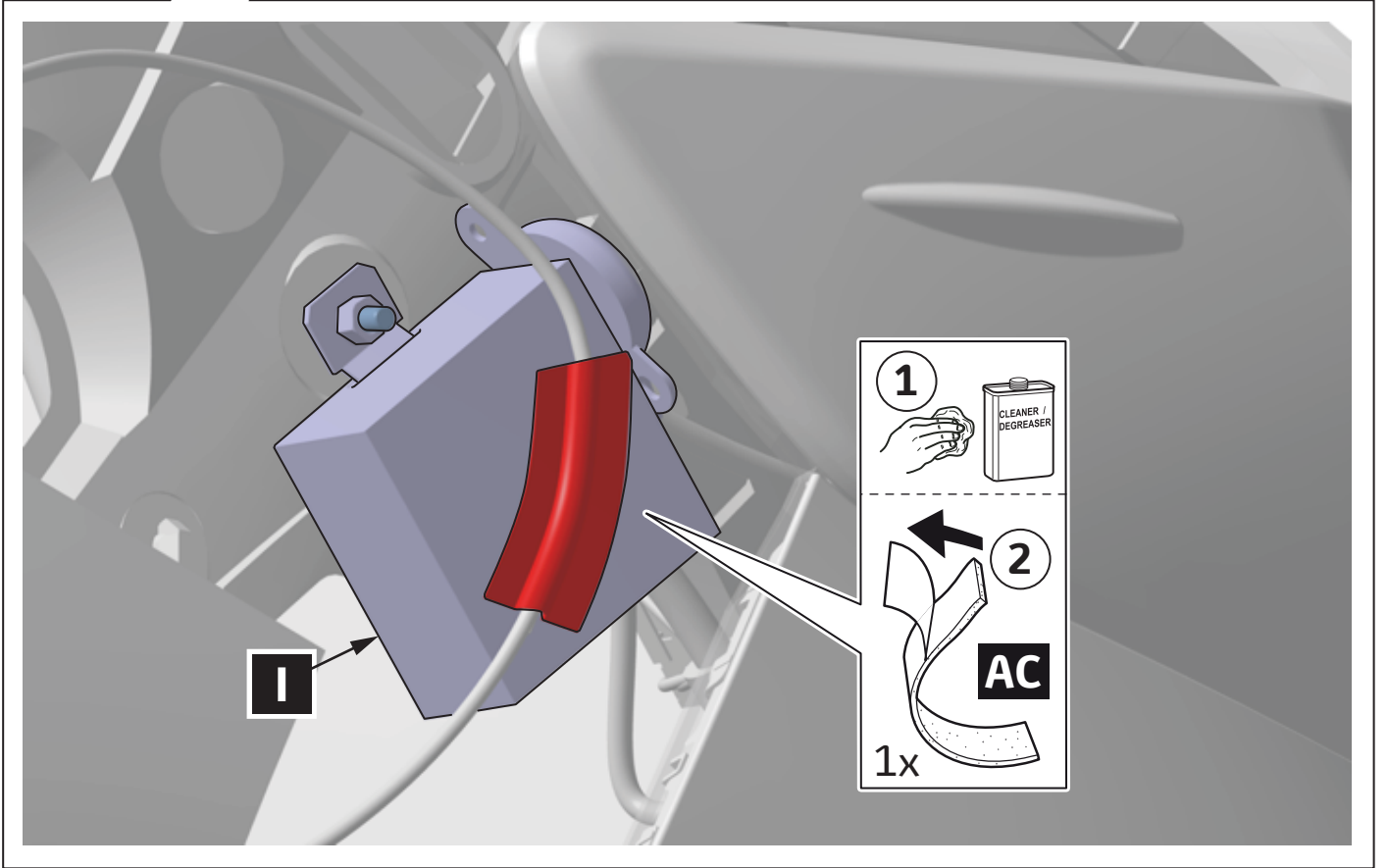
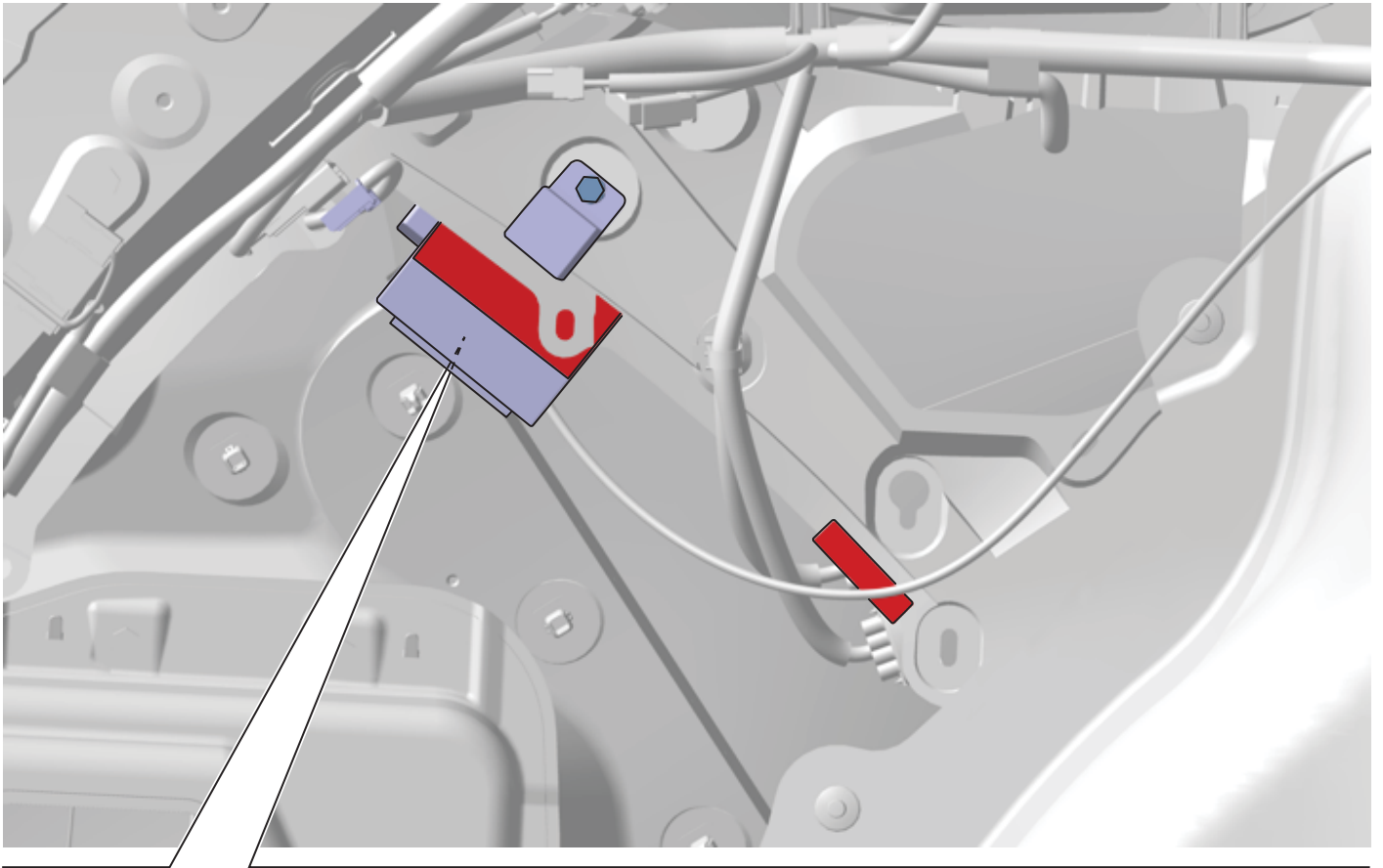

9



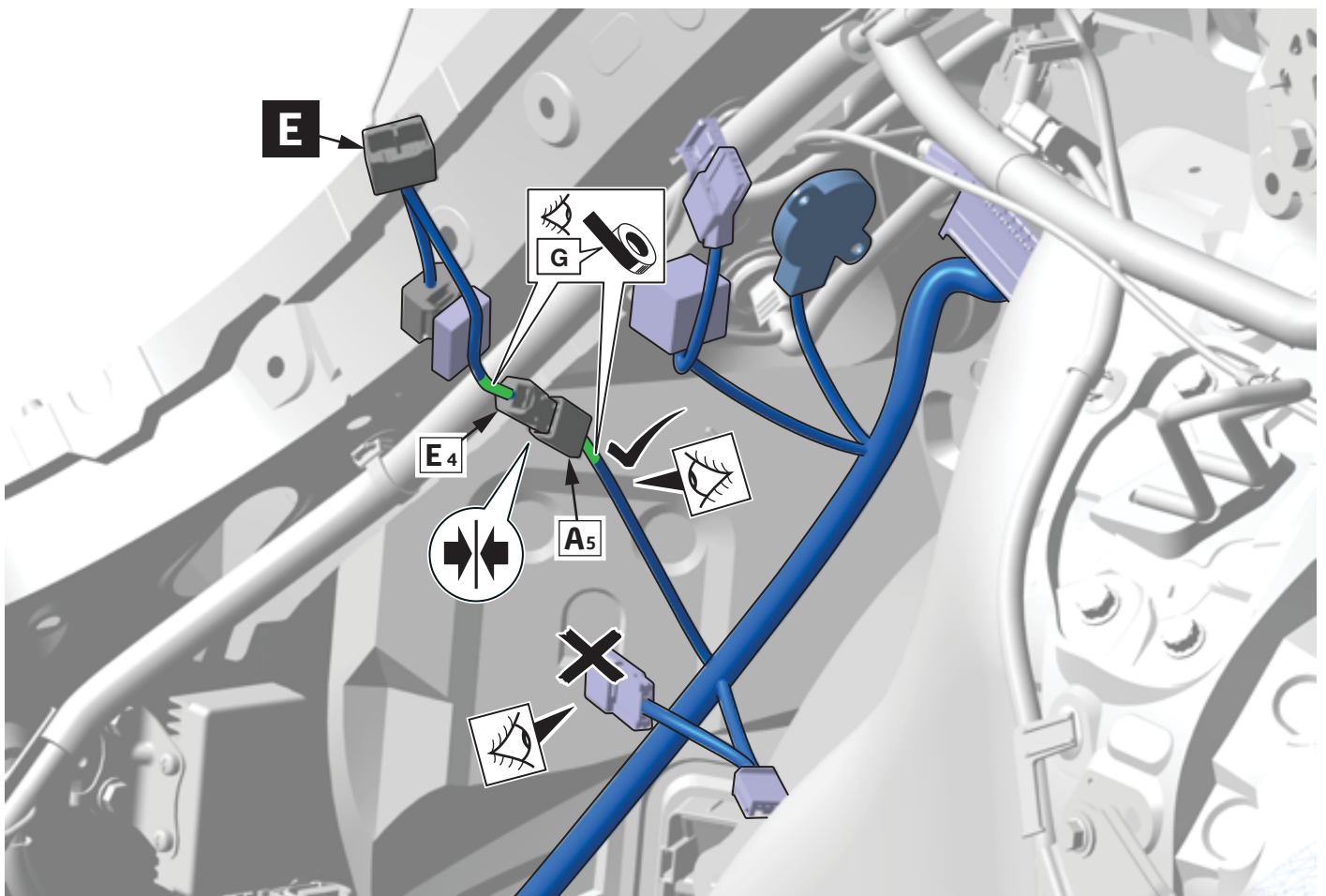
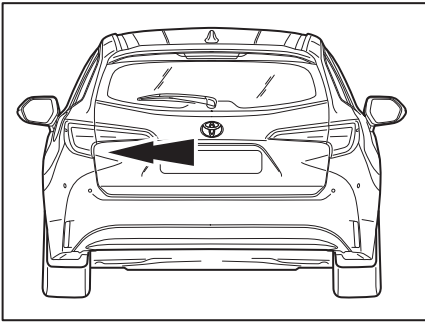

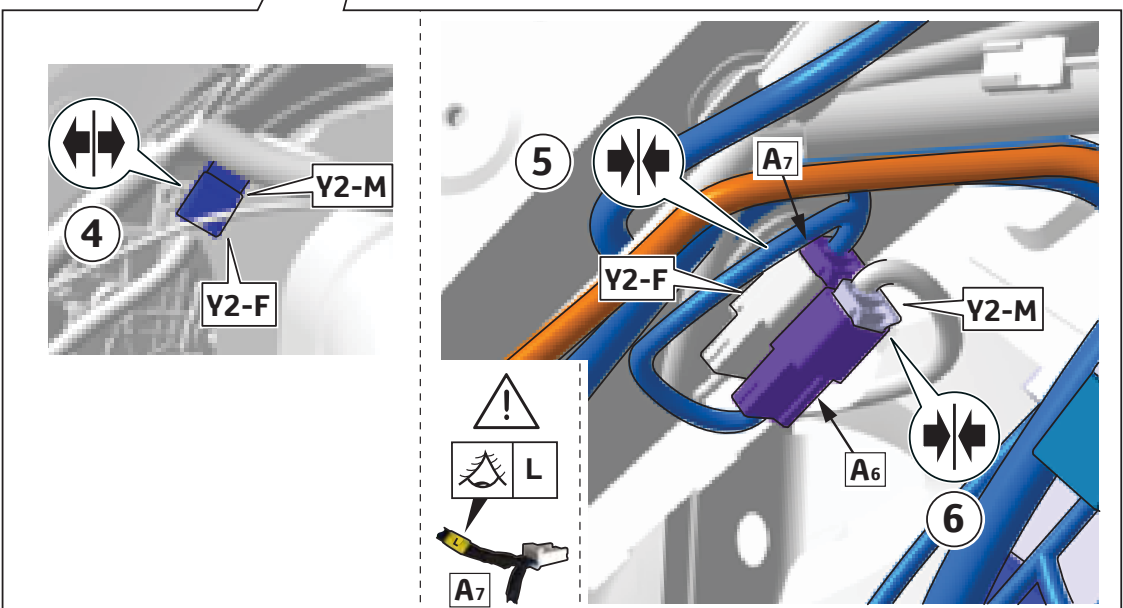
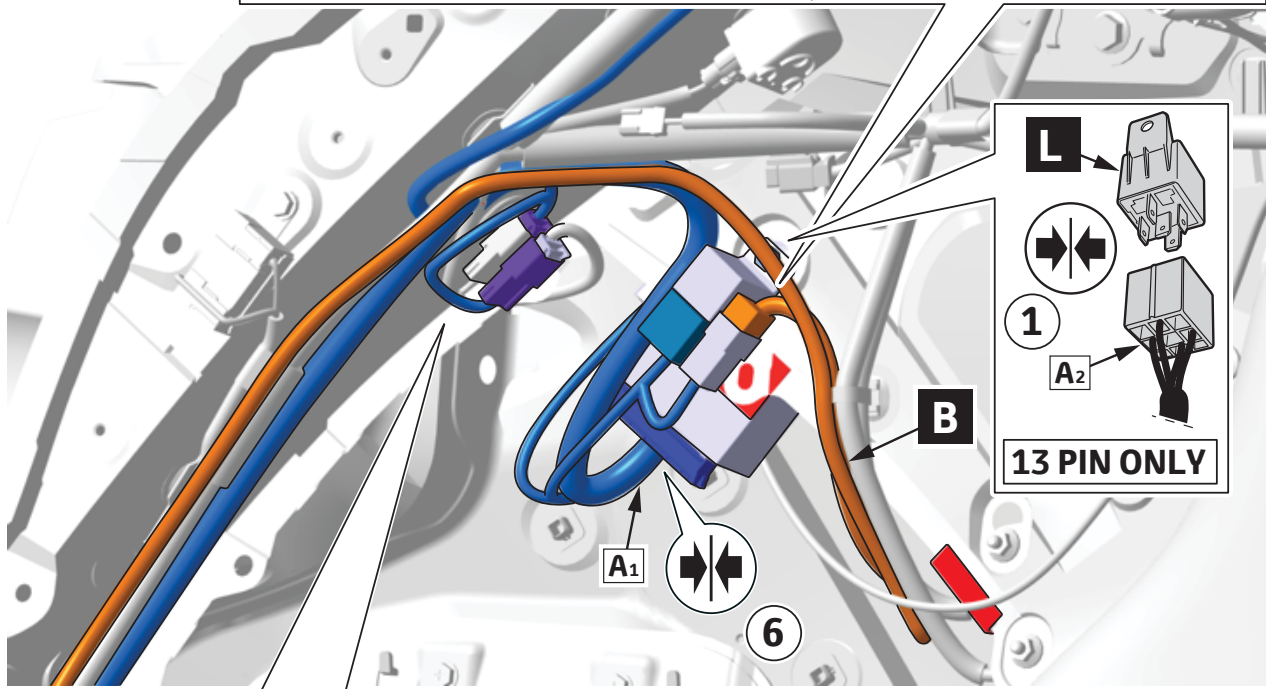
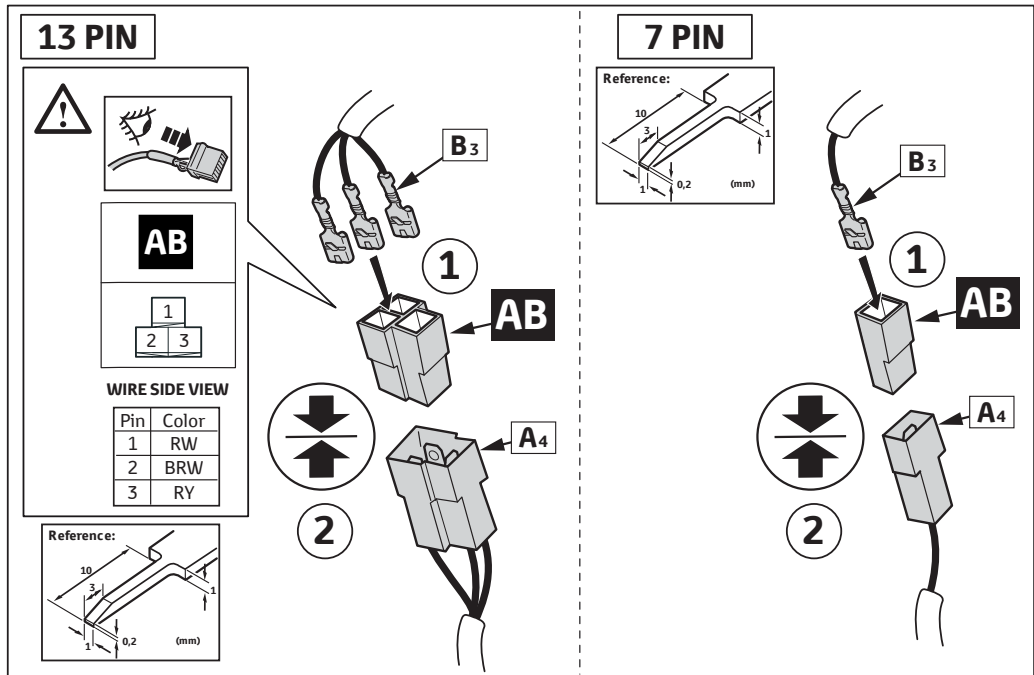

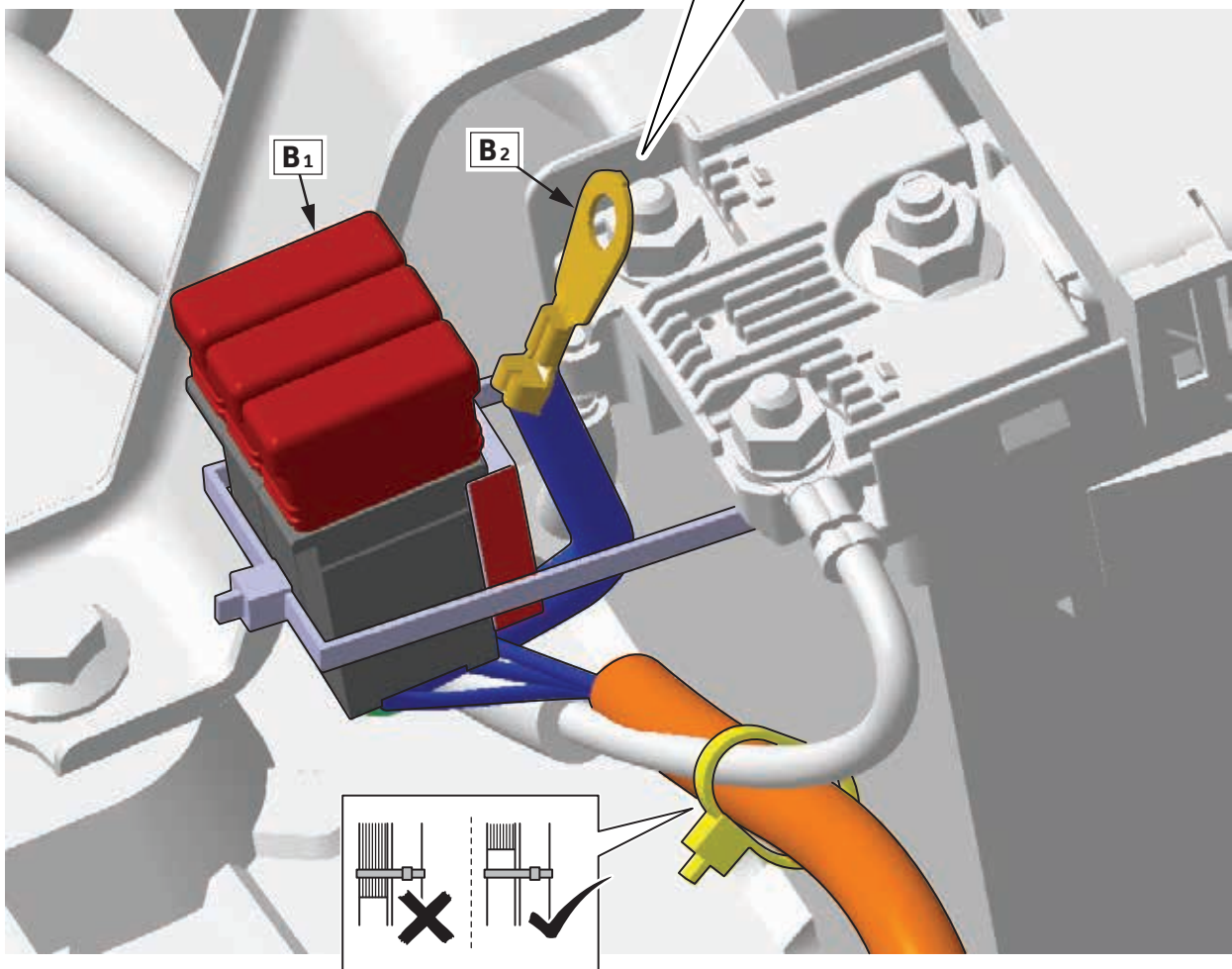
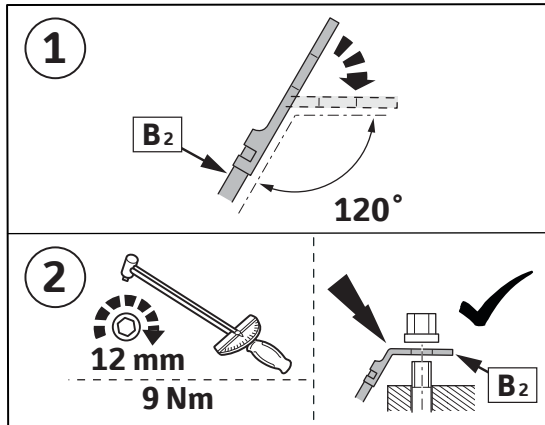

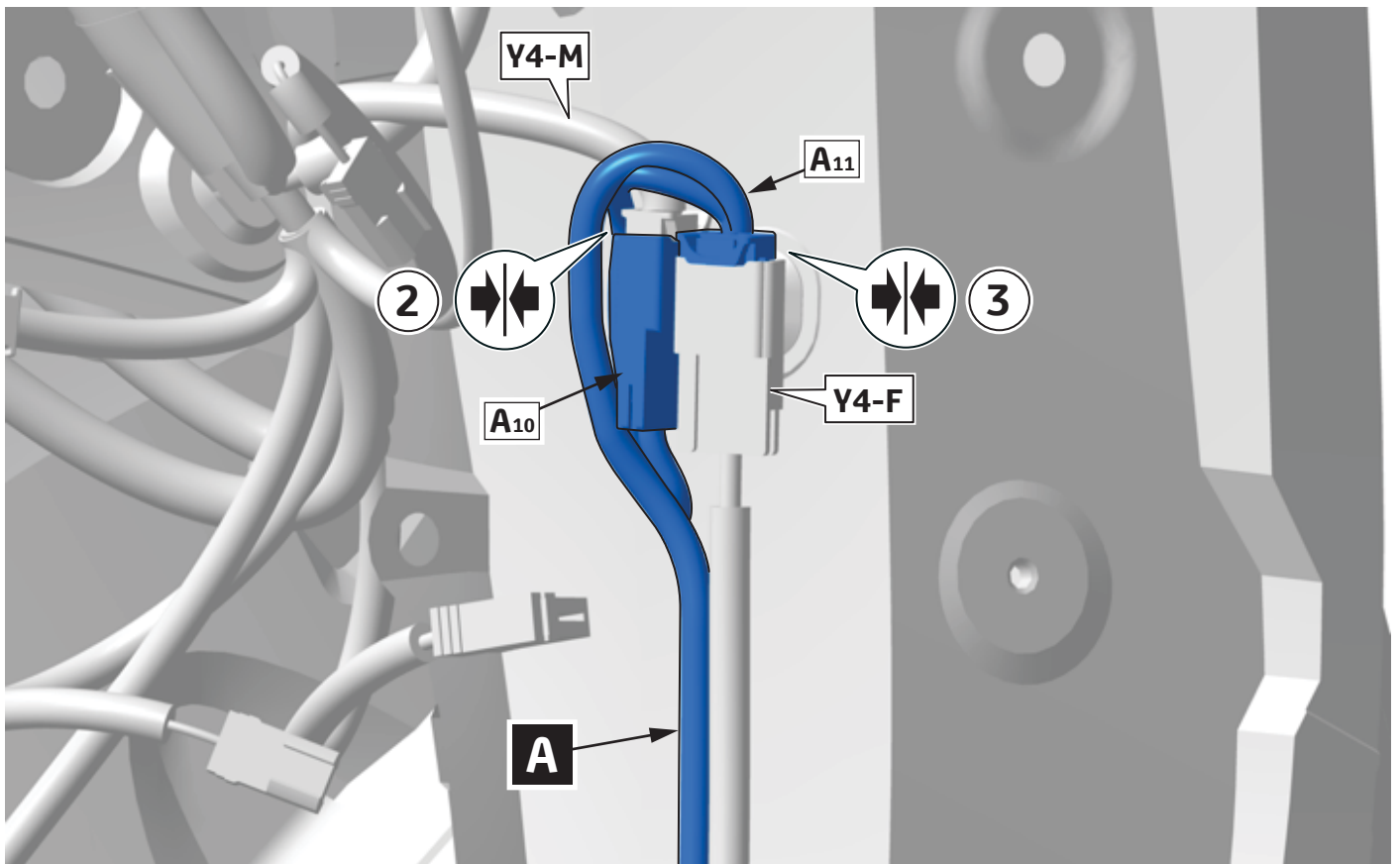
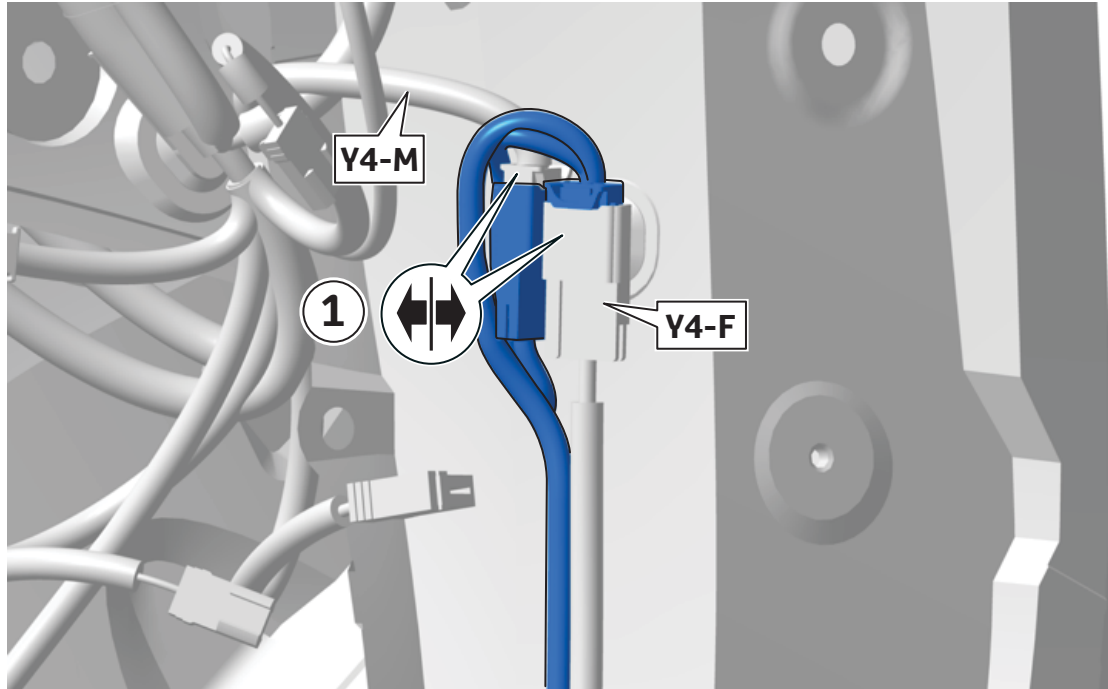
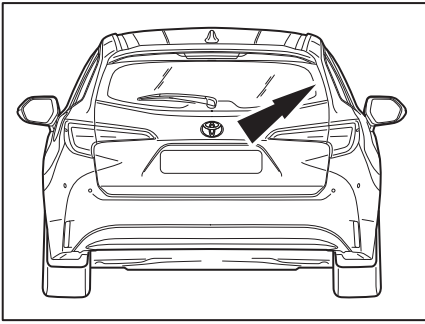

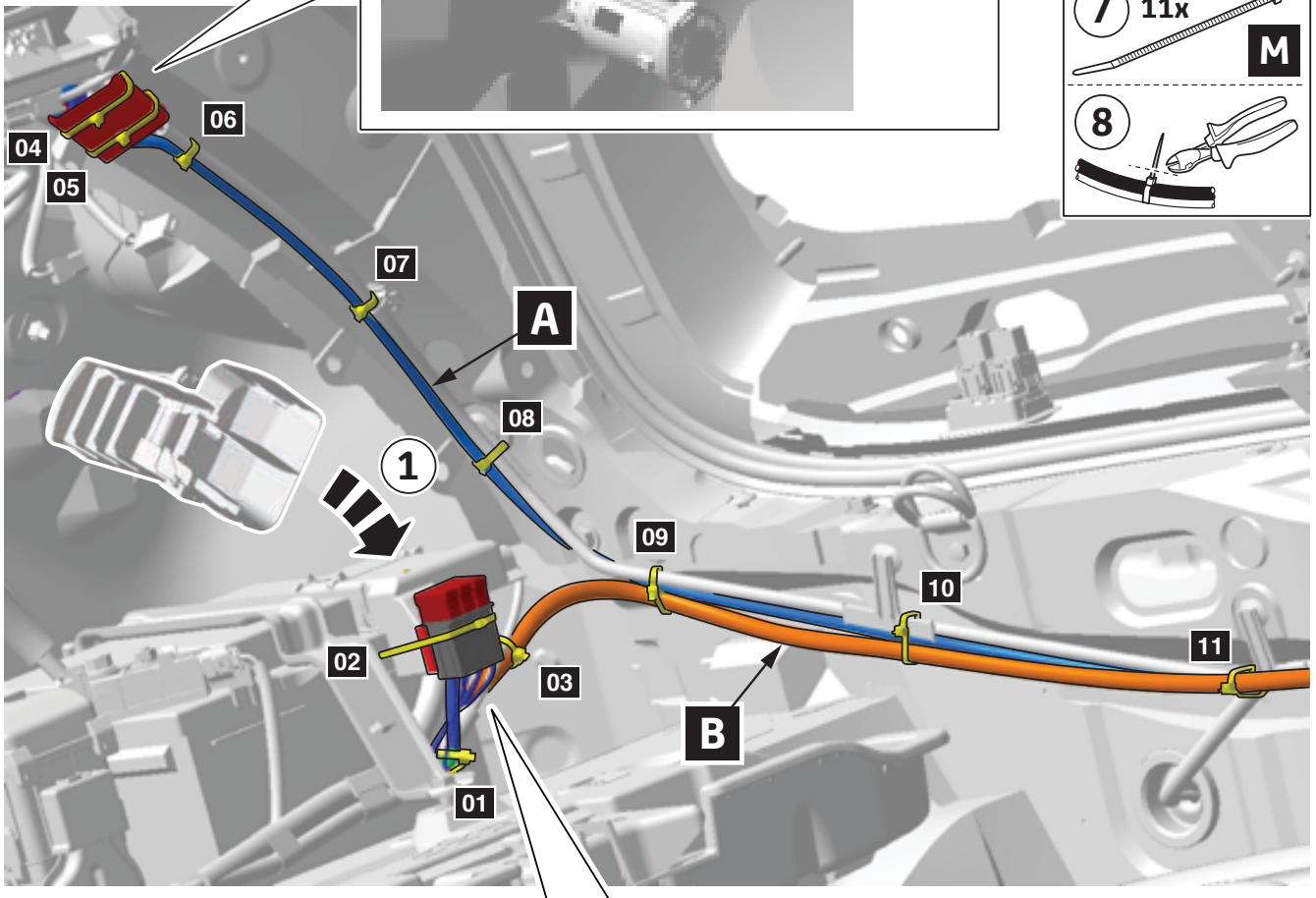
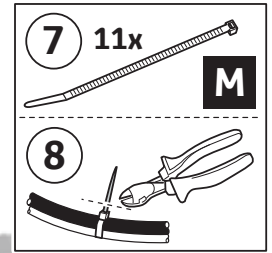
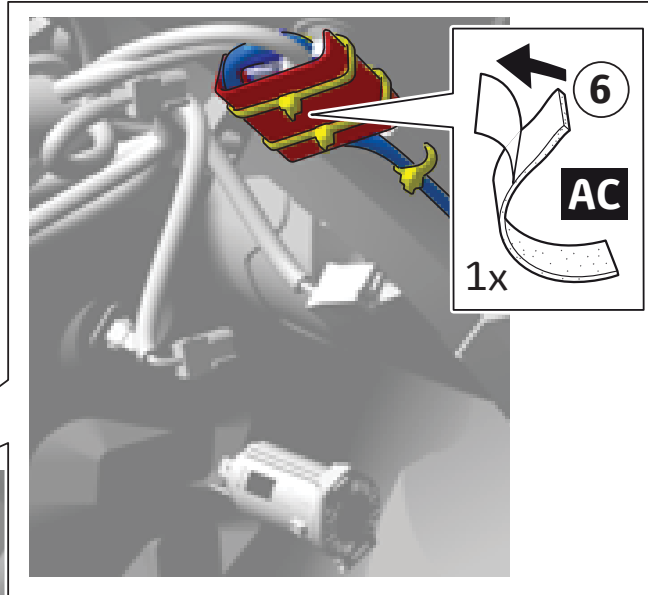

### 7 PIN

### 13 PIN

FUSE	WH Color
20A	W-R
15A	W-BR
15A	Y-R

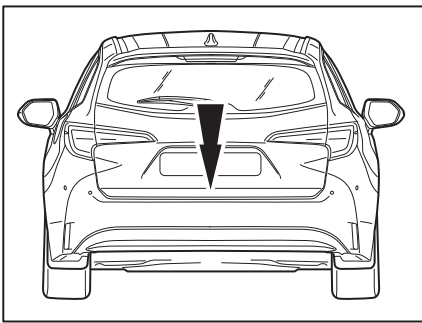

 **33 of 41**

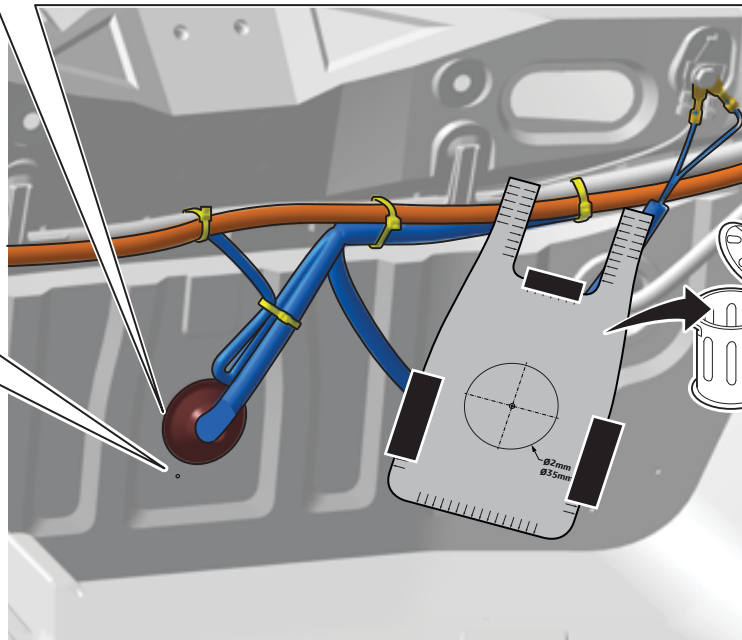
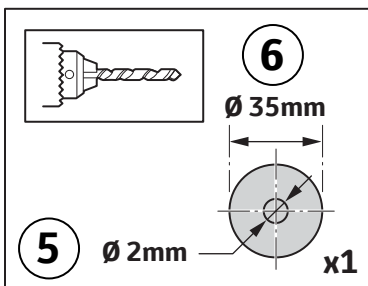
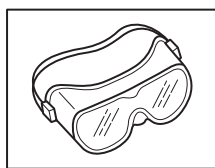
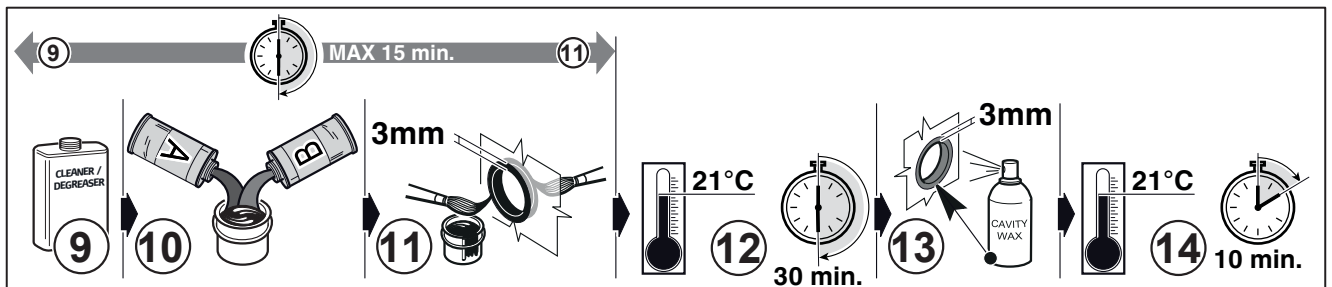
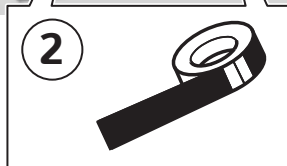
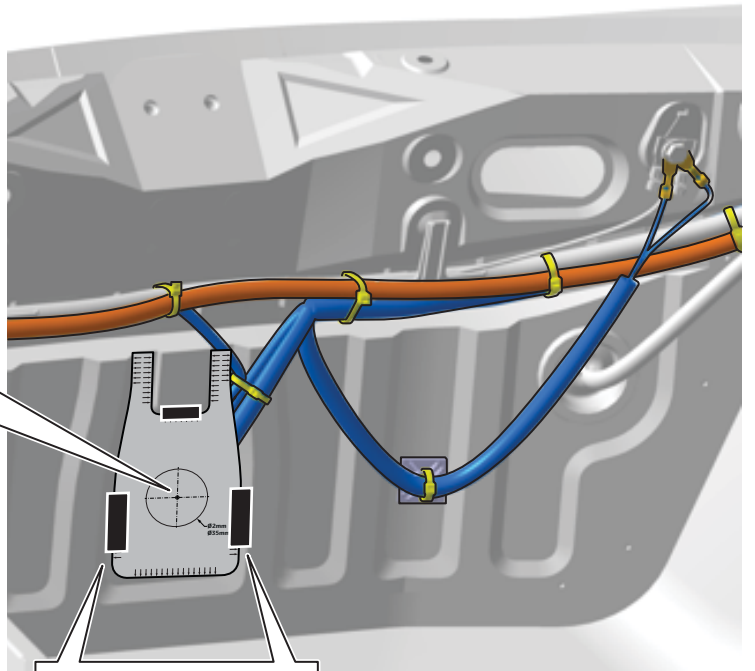
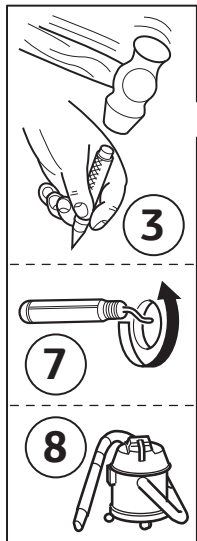
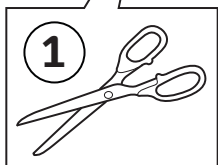
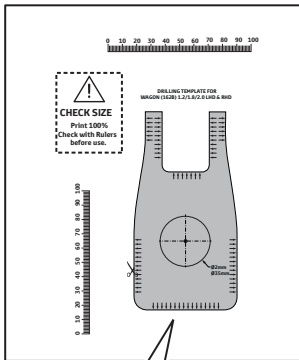

**4**

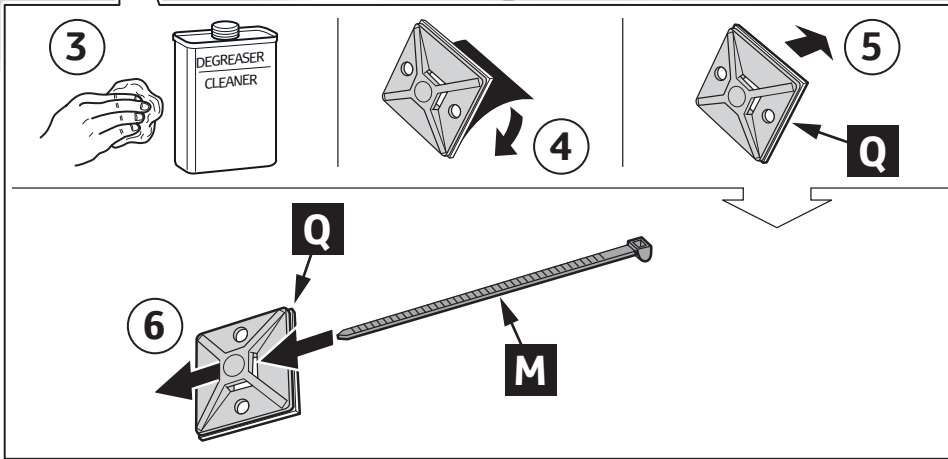
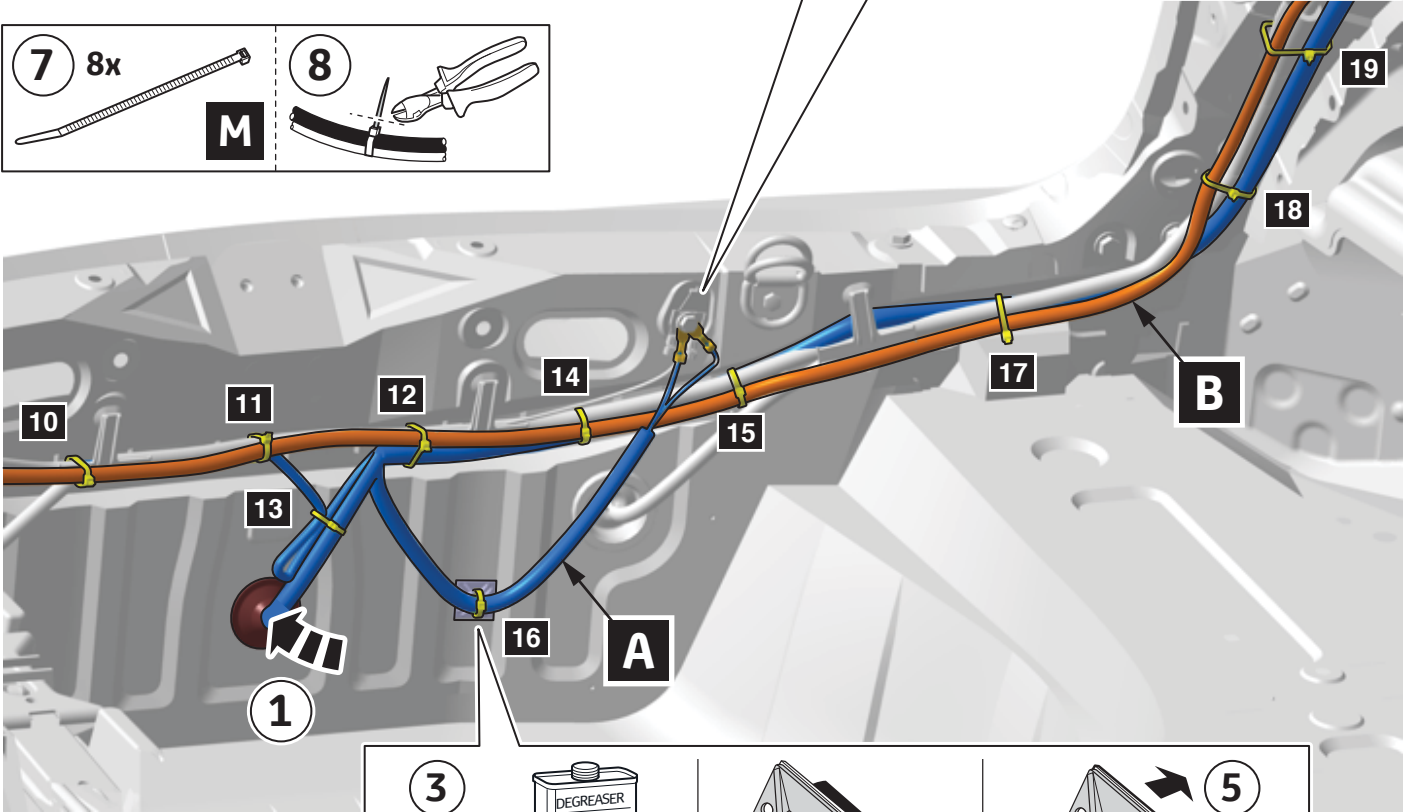
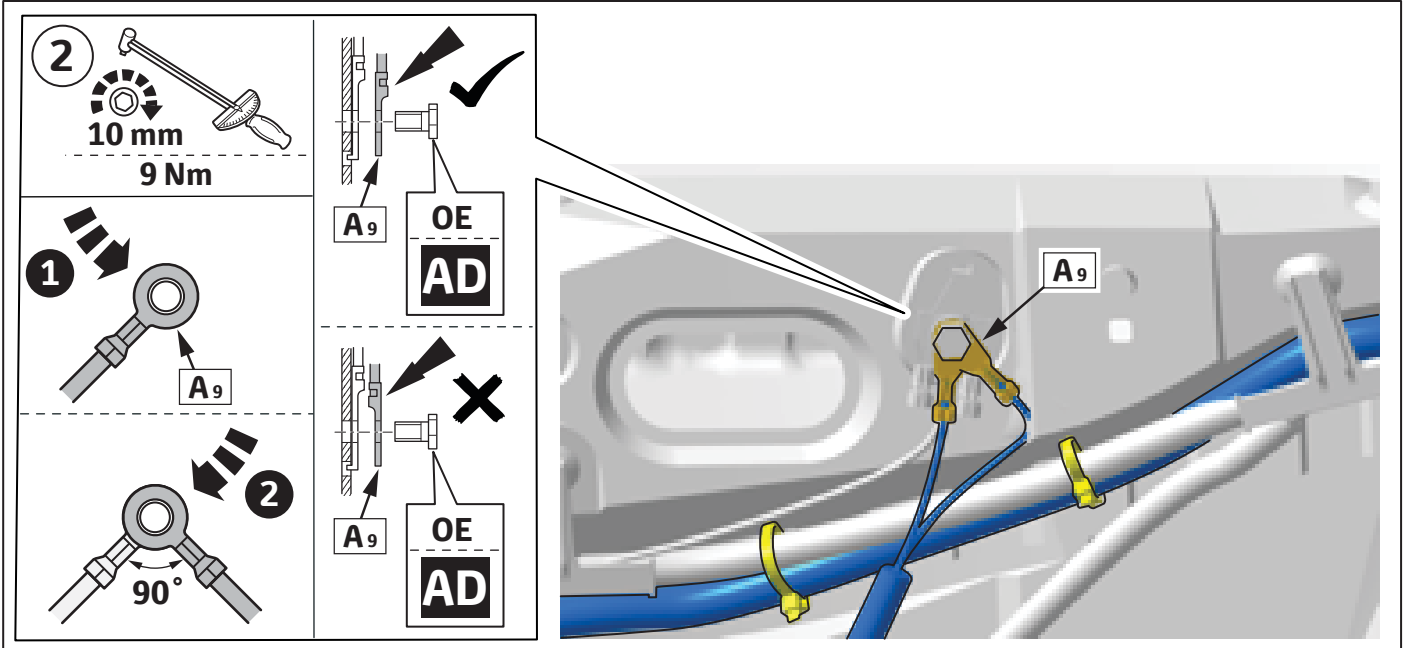

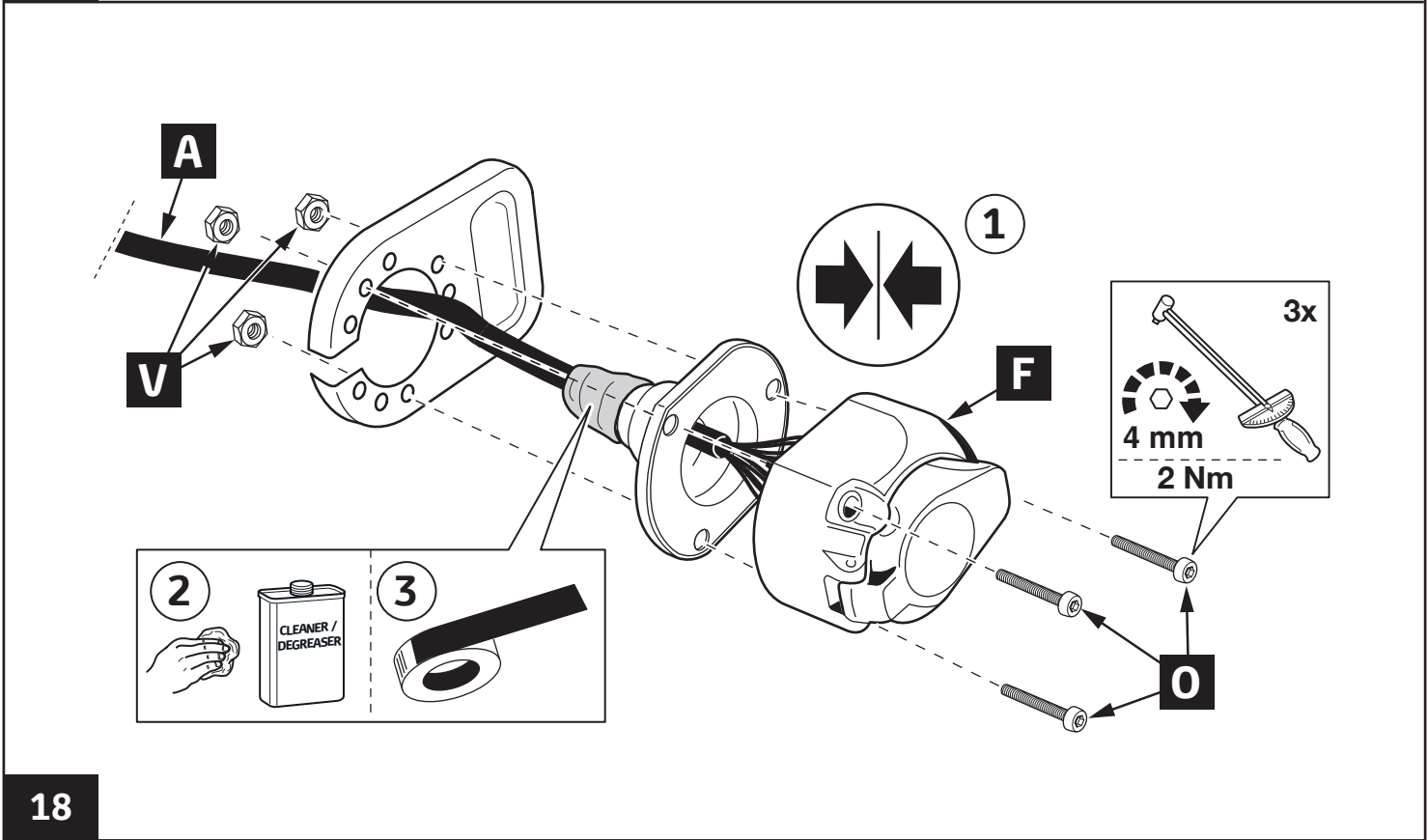
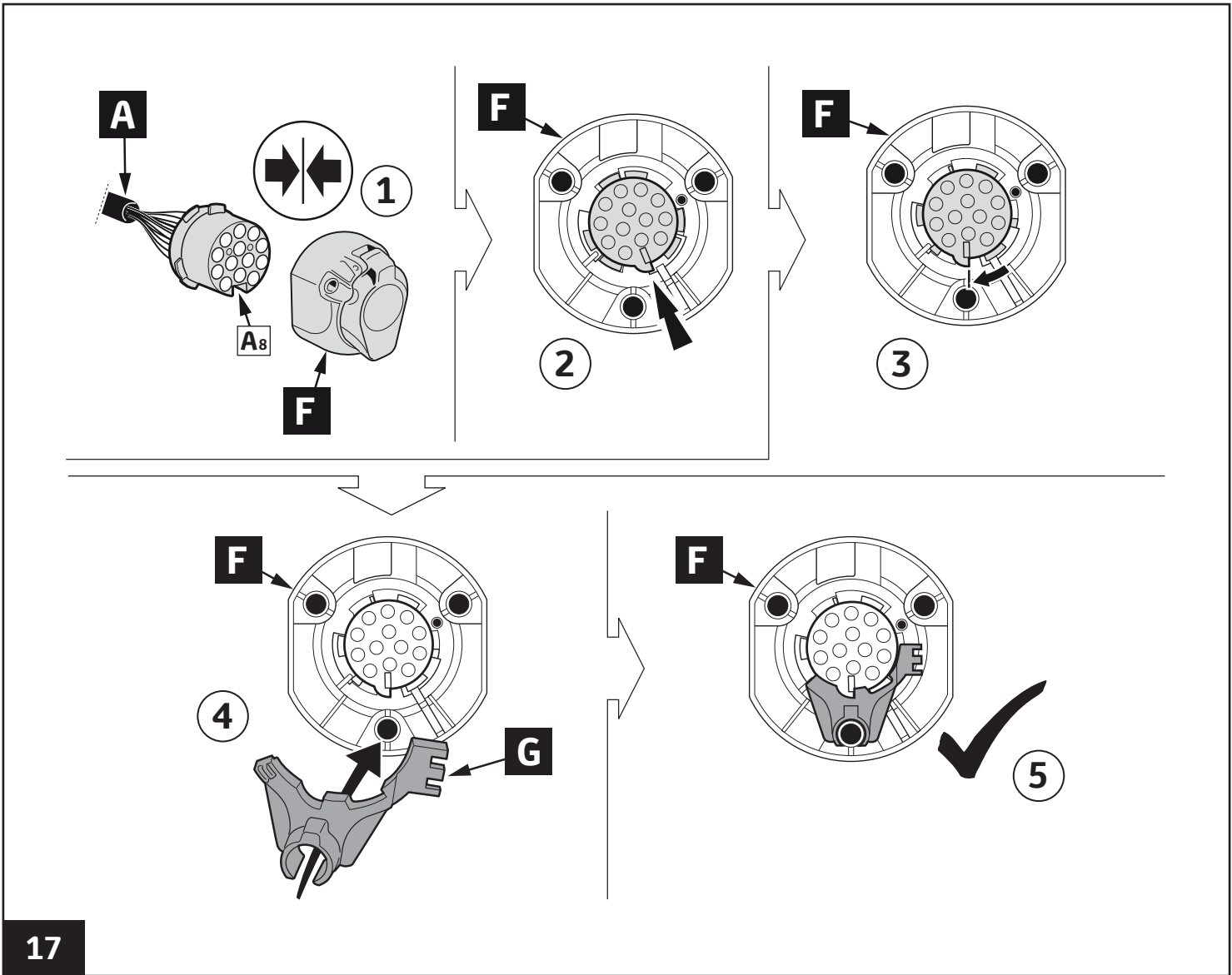



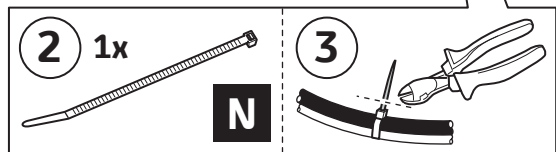
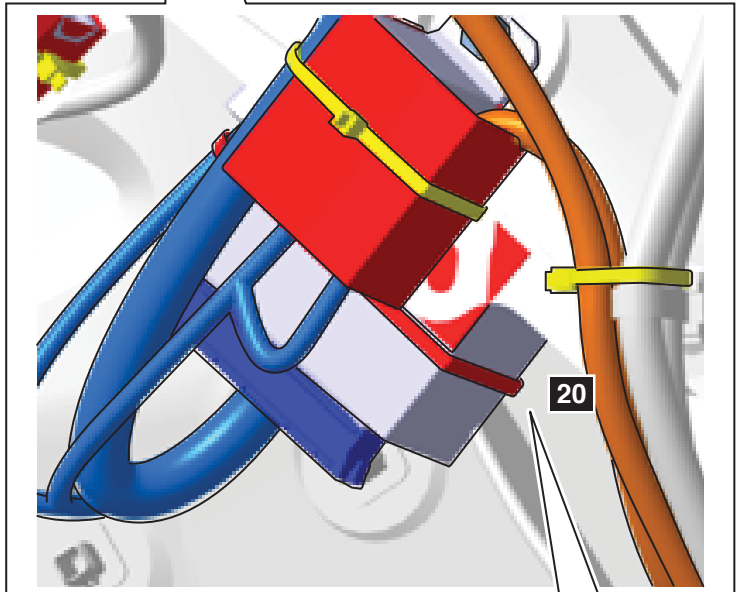
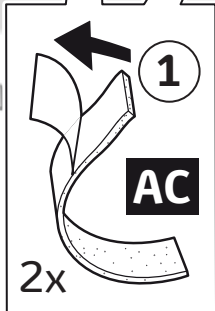
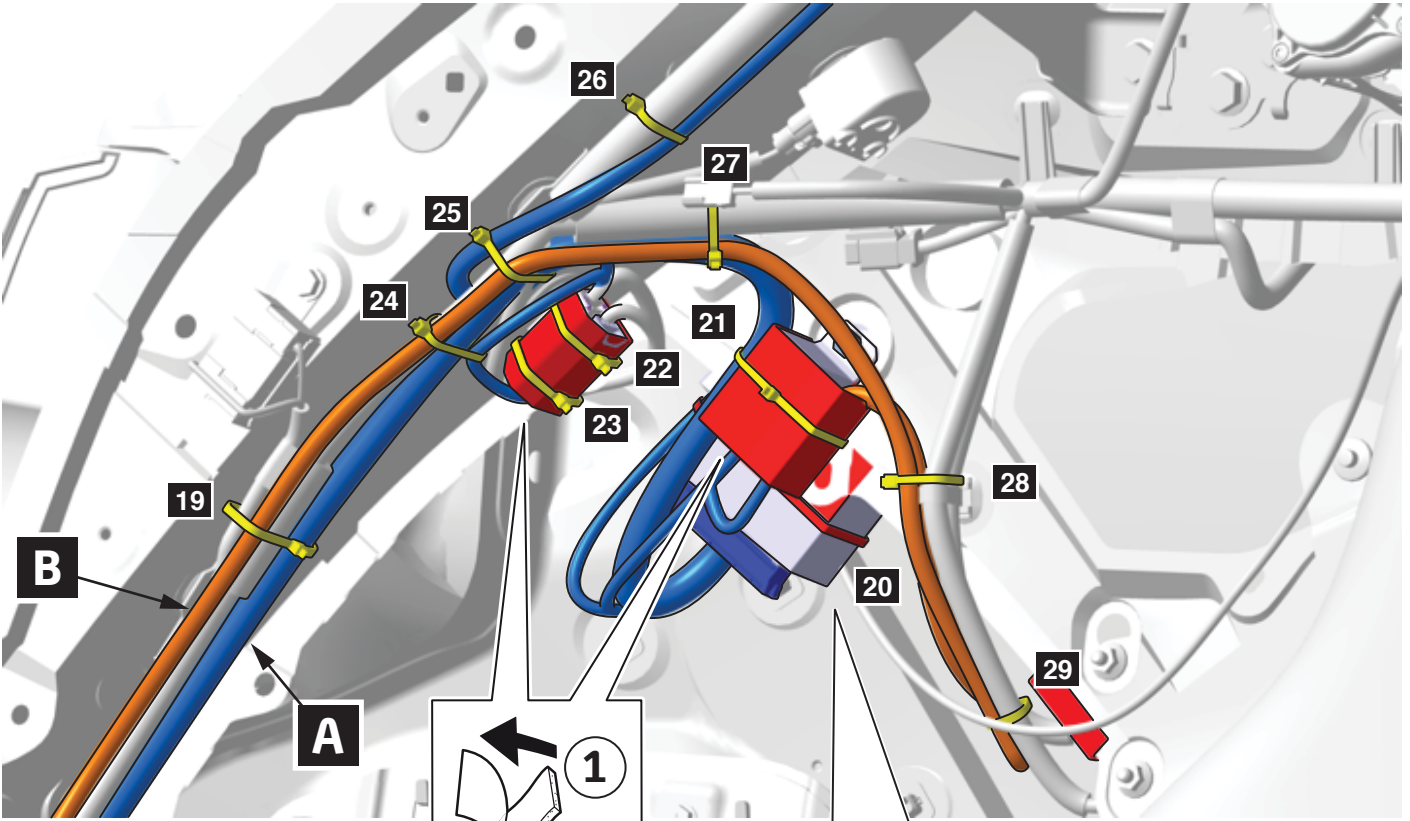
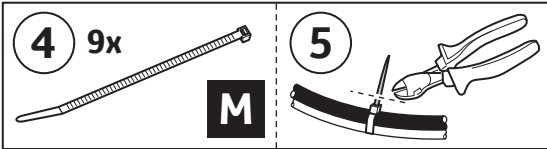

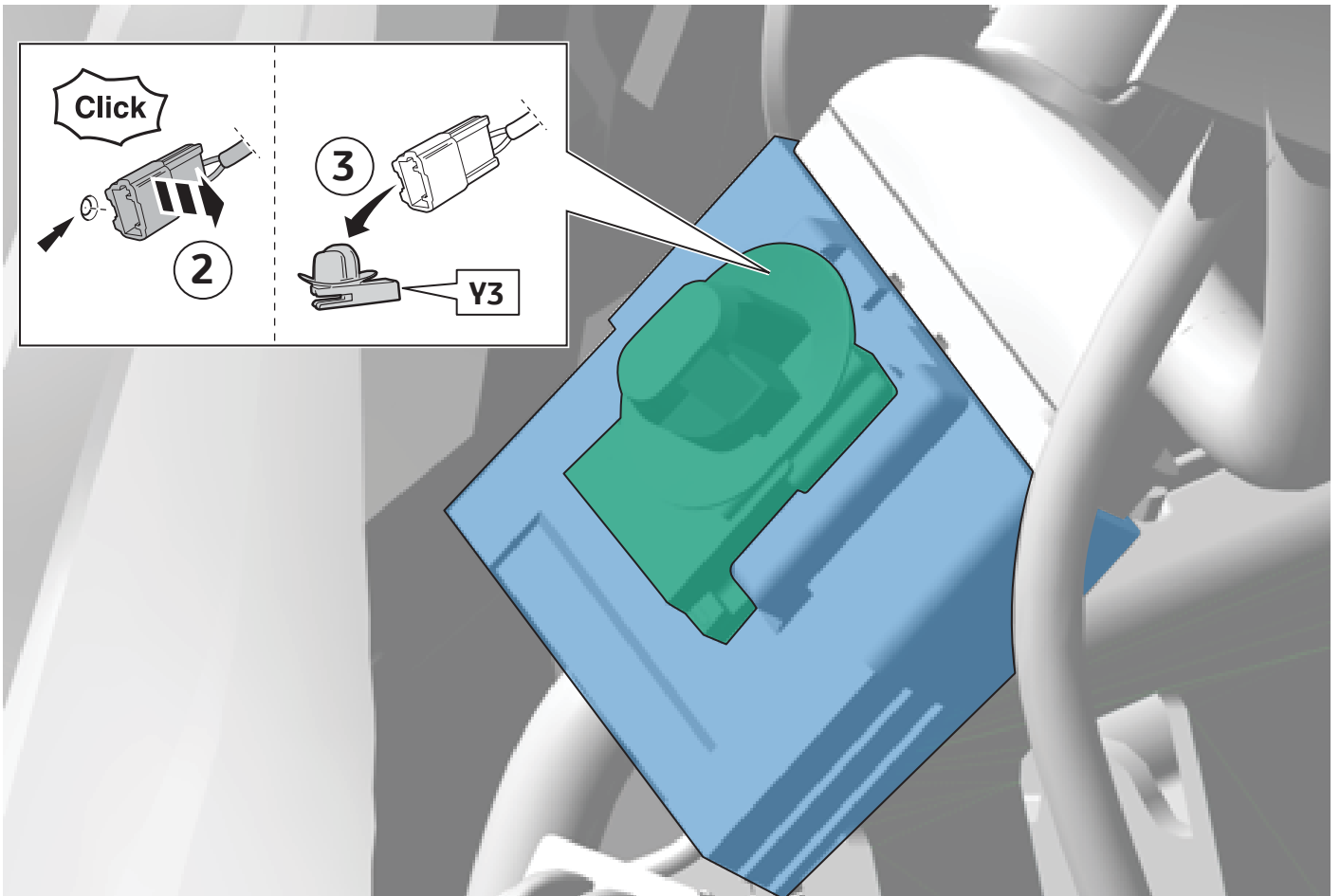
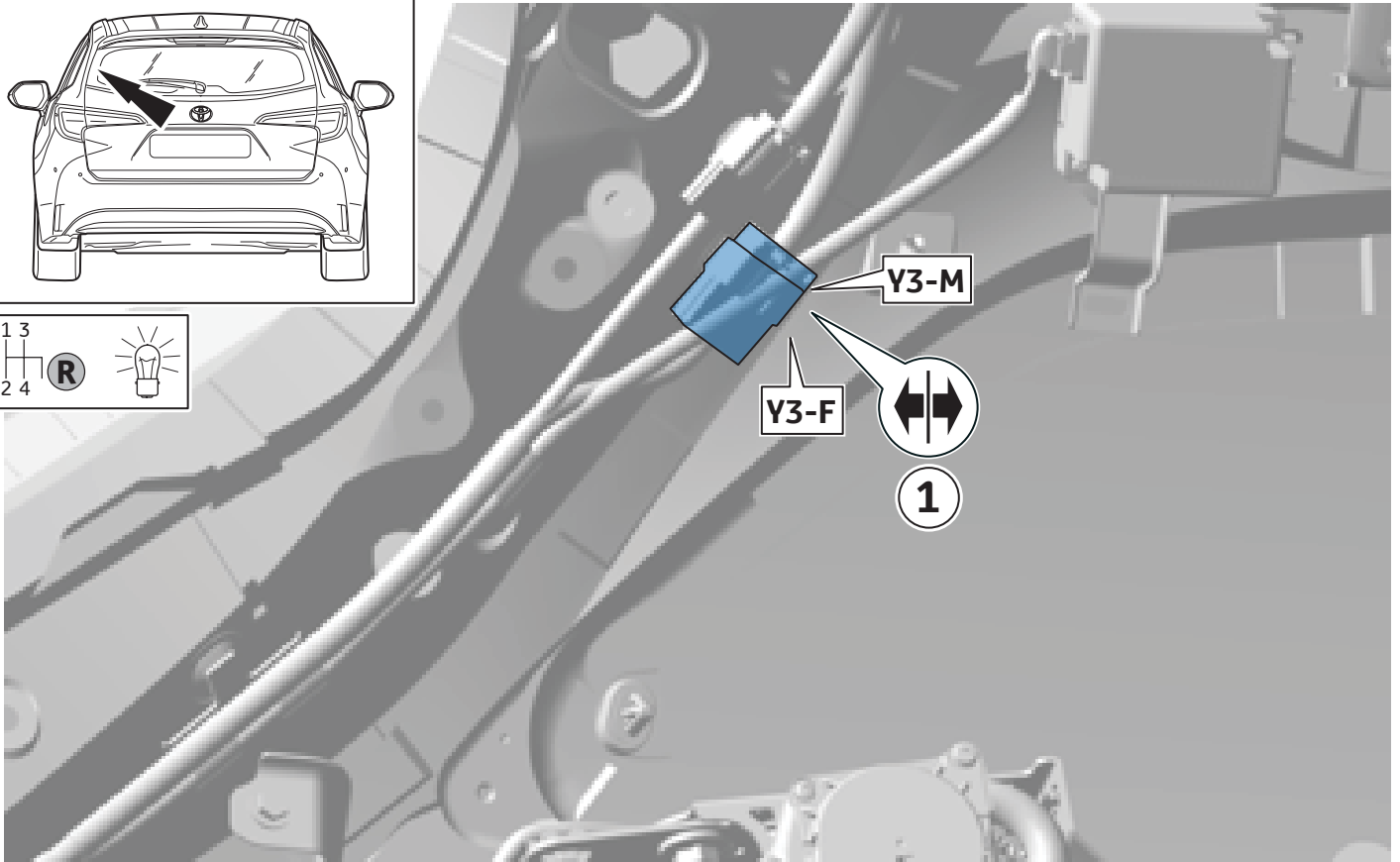
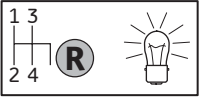
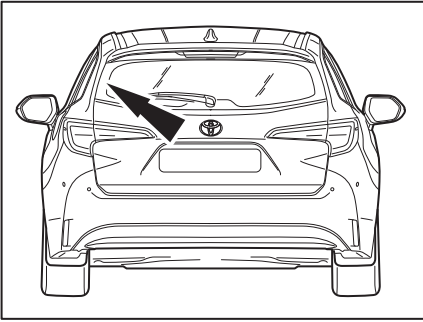

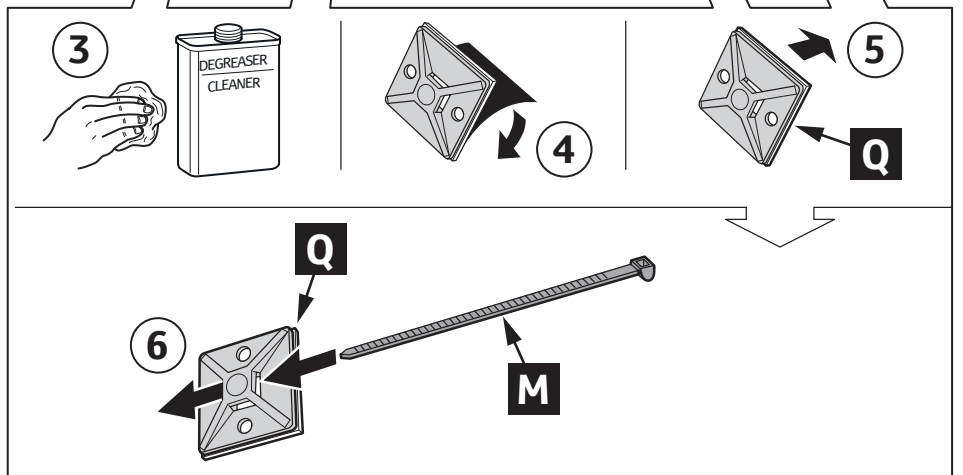
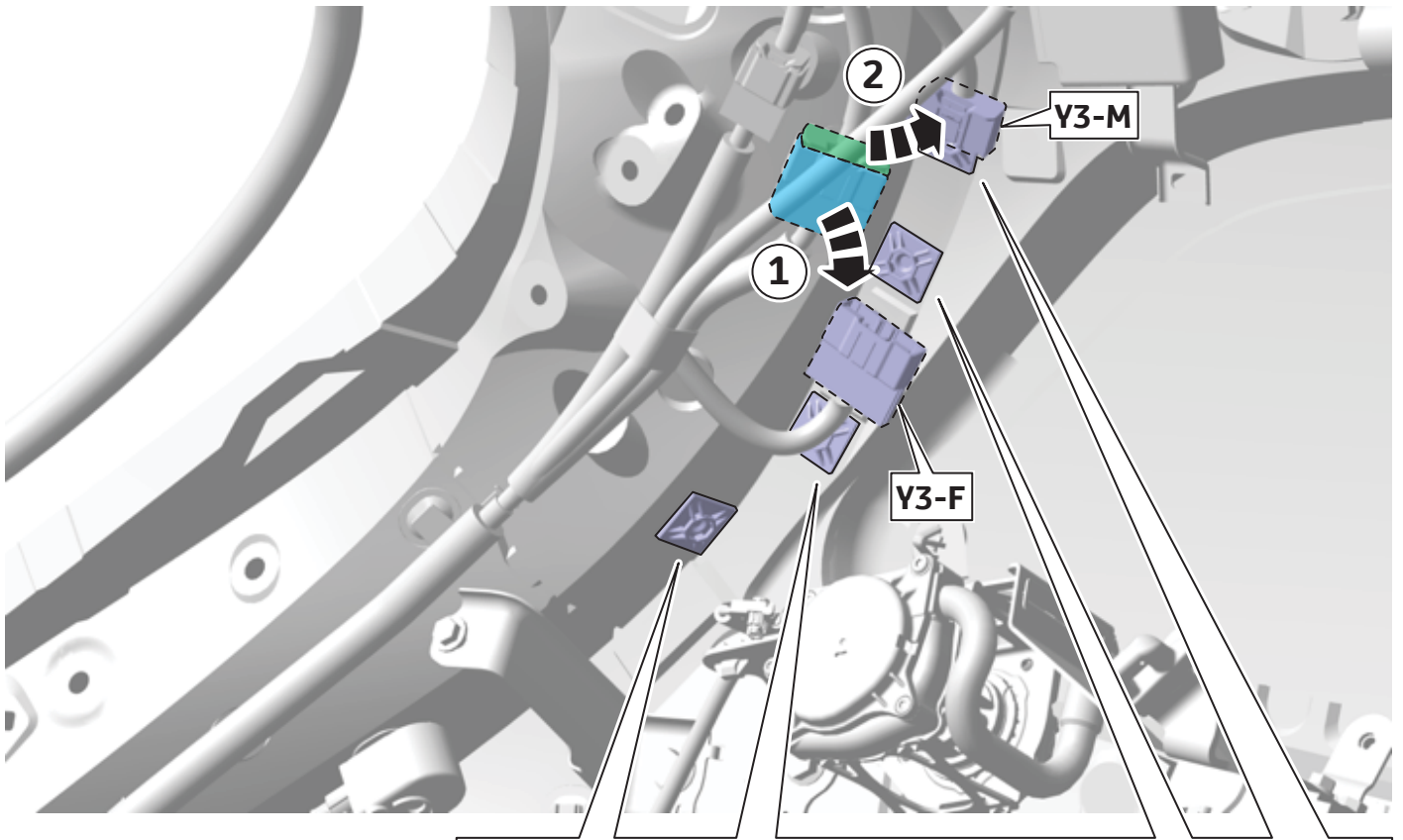
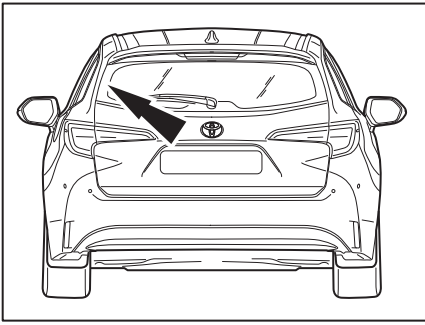

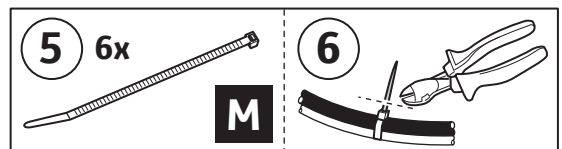
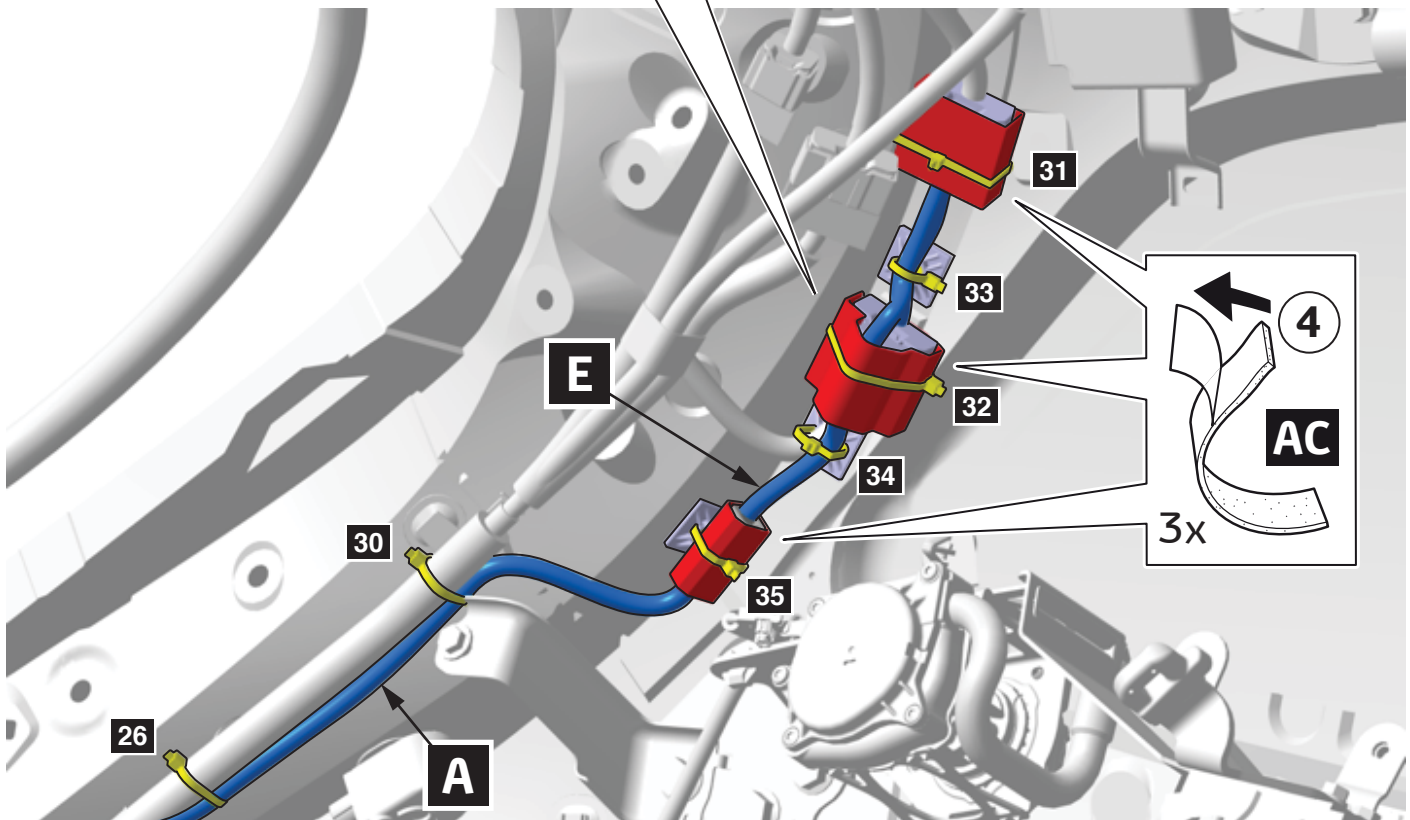
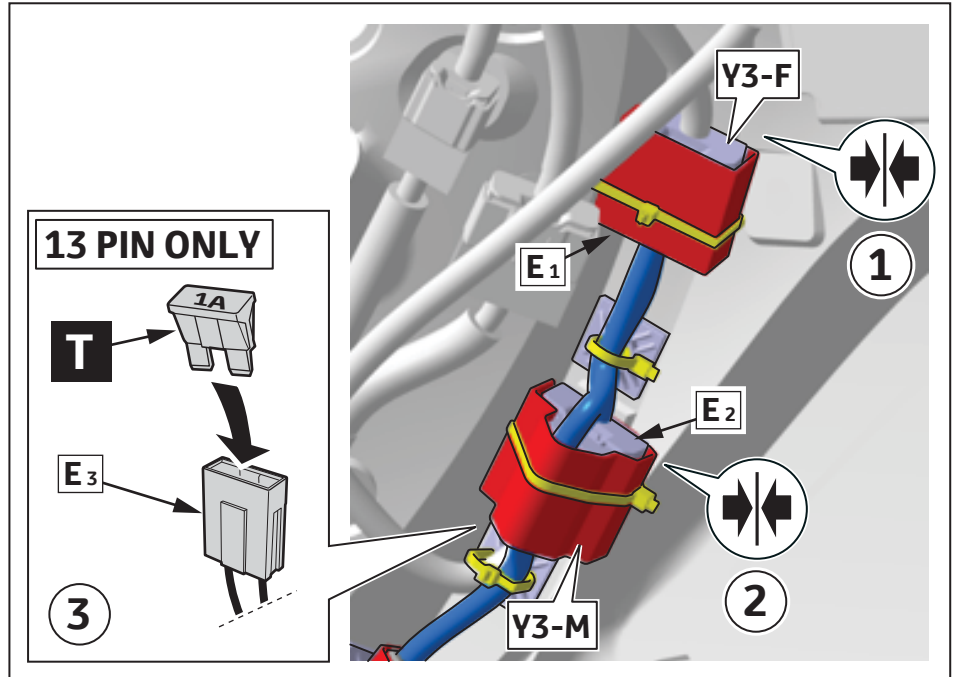
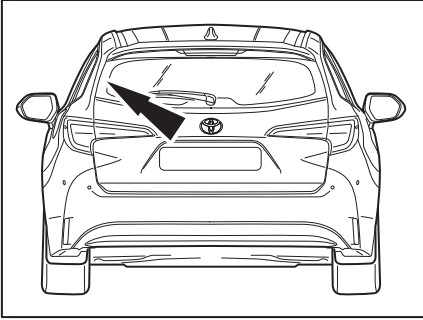

# VERTICAL DETACHABLE

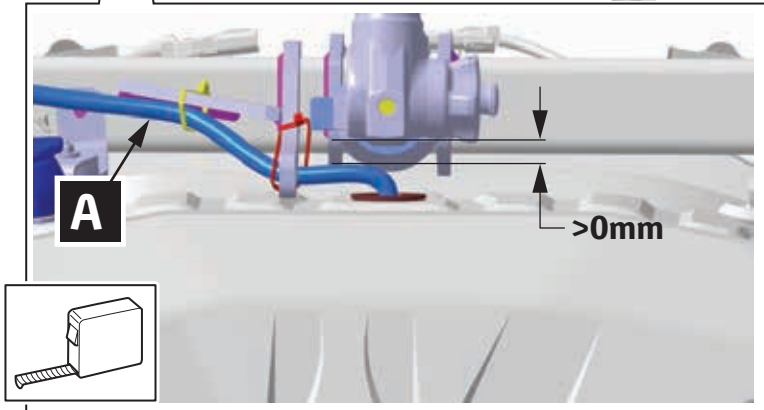
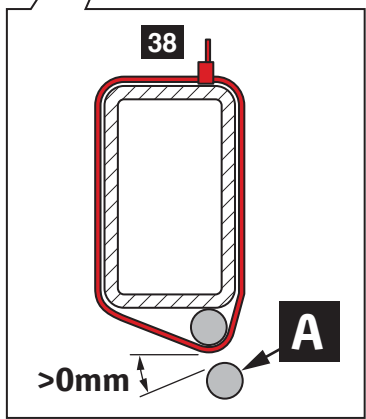
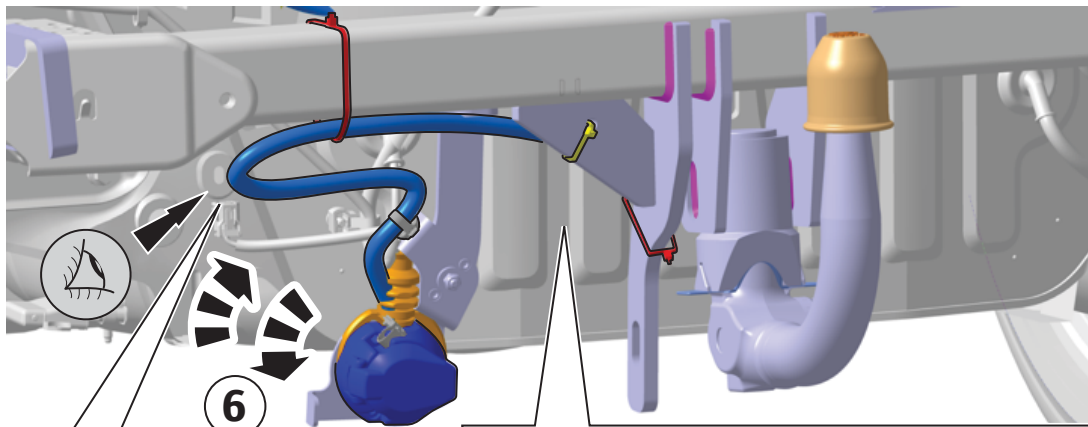
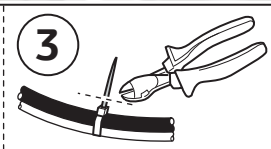
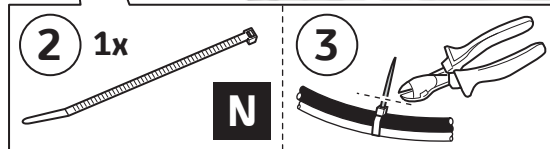
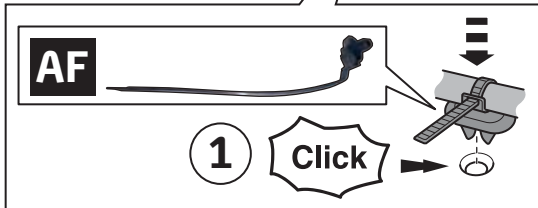
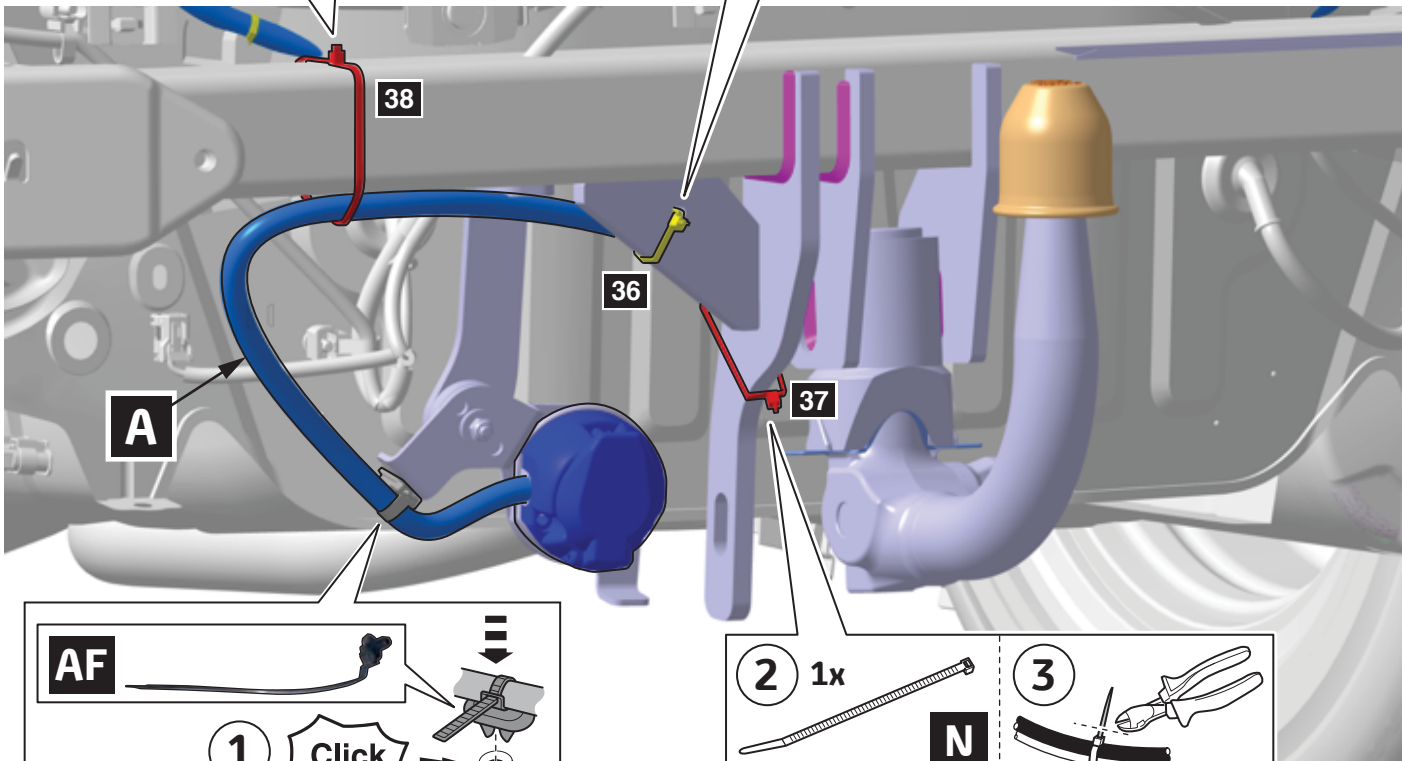
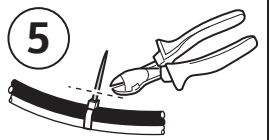
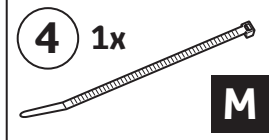
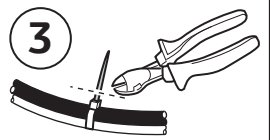
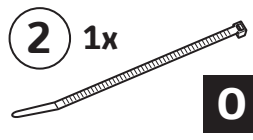

## HORIZONTAL DETACHABLE

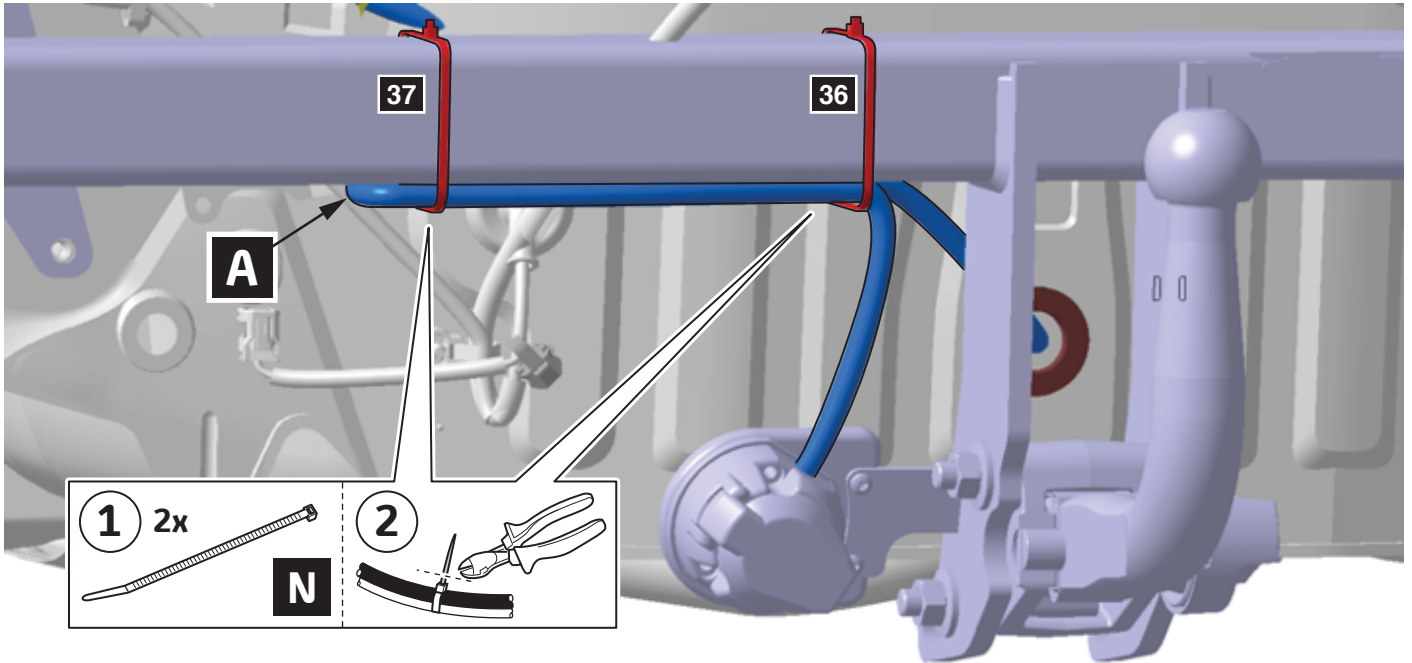

## FIXED

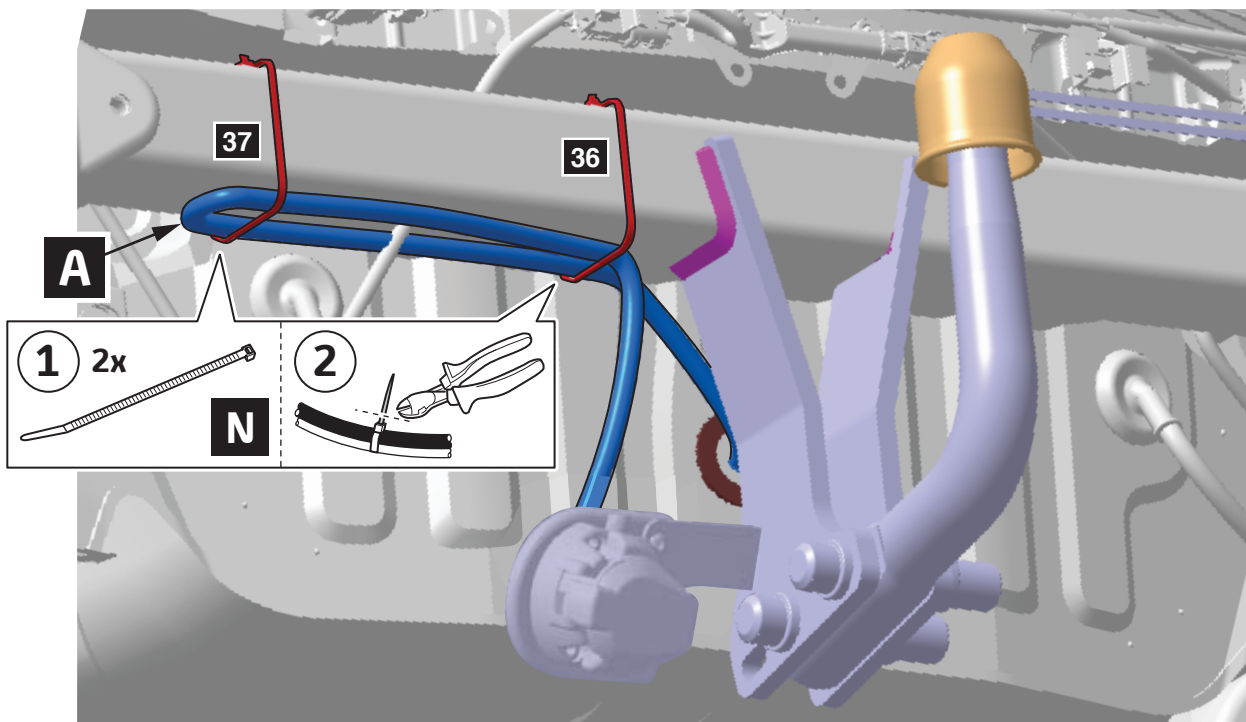

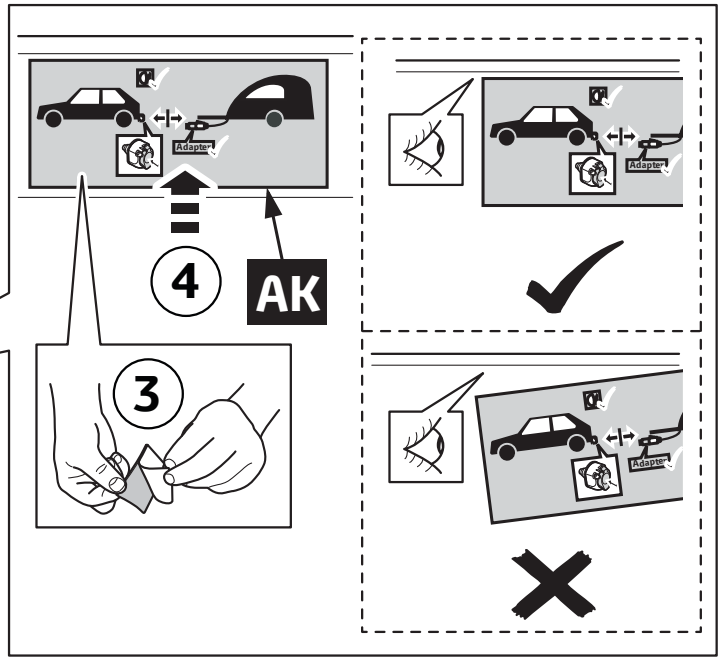
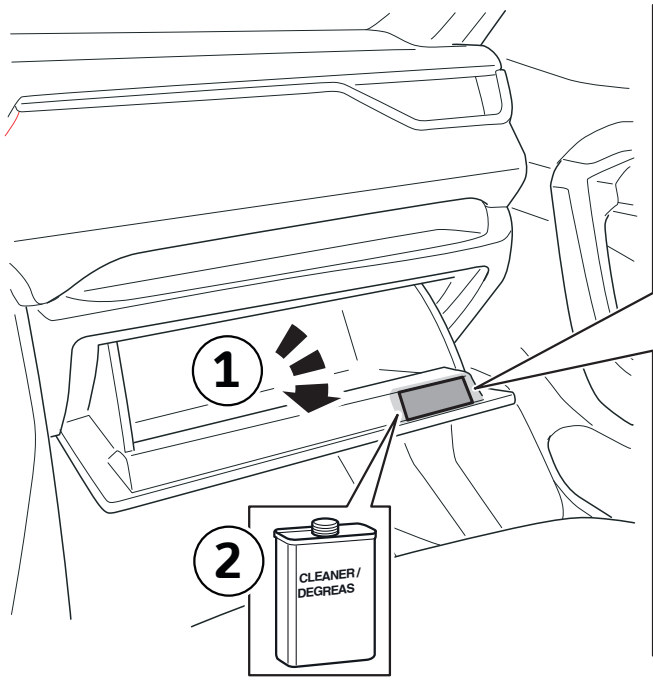

25

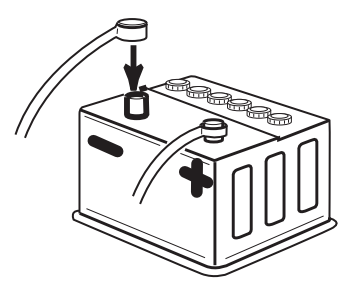
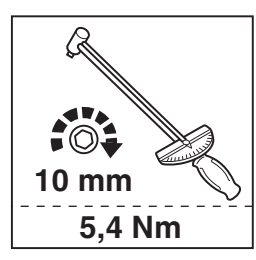

26

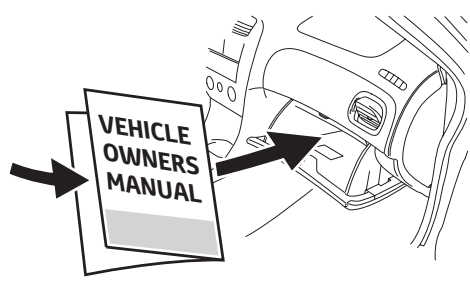
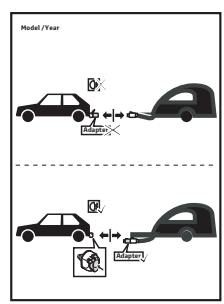

27

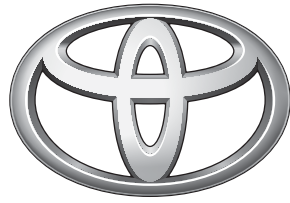

**TOYOTA**





## CHECK SIZE

Print 100%  
Check with Rulers  
before use.

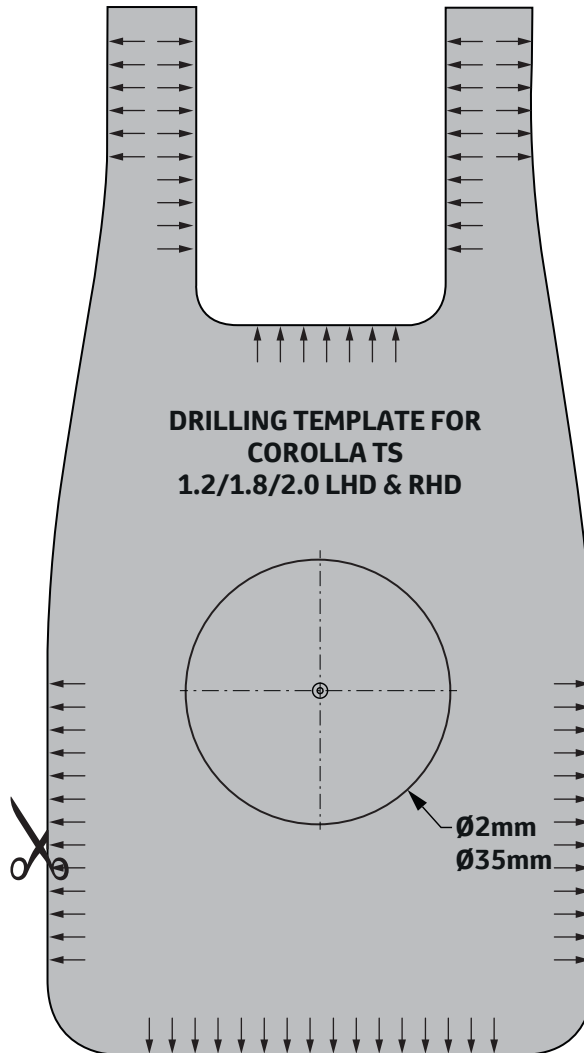
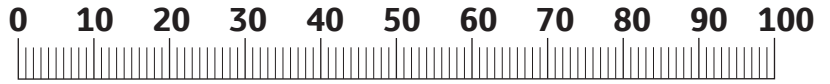

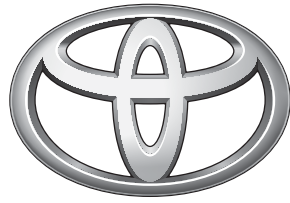

**TOYOTA**



**TOYOTA**

Model/Year

Corolla (TS & 2.0L)  
2019/02

Towbar wiring kit 13-pin  
Towbar wiring kit 7-pin

ALWAYS A  
BETTER WAY

VIN n°

## DURING INSTALLATION

**1**

**P/N = OK**

**=A**      **=B**

**2**

**Z**      **W**

**9 Nm**           

**Click**

**Serial Number**

**3**

**O**  
(3x)  
**2 Nm**      **Serial Number**

**Click**

**4**

**A<sub>9</sub>**

**9 Nm**      **Serial Number**

**Click**

**5**

**7 PIN**

**AJ**      **S**      **B<sub>1</sub>**

**20A**

**A**     

**B**

**13 PIN**

**AJ**      **S**      **R**      **T**      **D<sub>3</sub>**      **B<sub>1</sub>**

FUSE	WH Color
20A	W-R
15A	W-BR
15A	Y-R



**1A**      **15A**      **15A**      **20A**

**A**                       

**B**



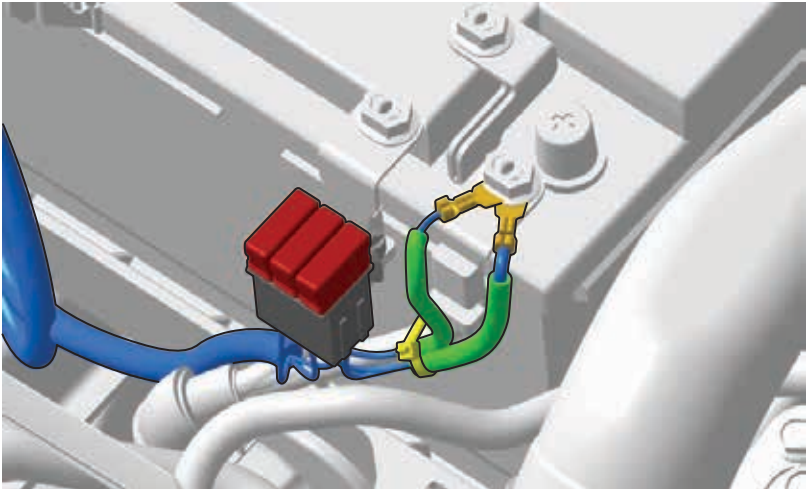

**6**

**9 Nm**    **Serial Number**

**7**

**(2x)**    **Serial Number**

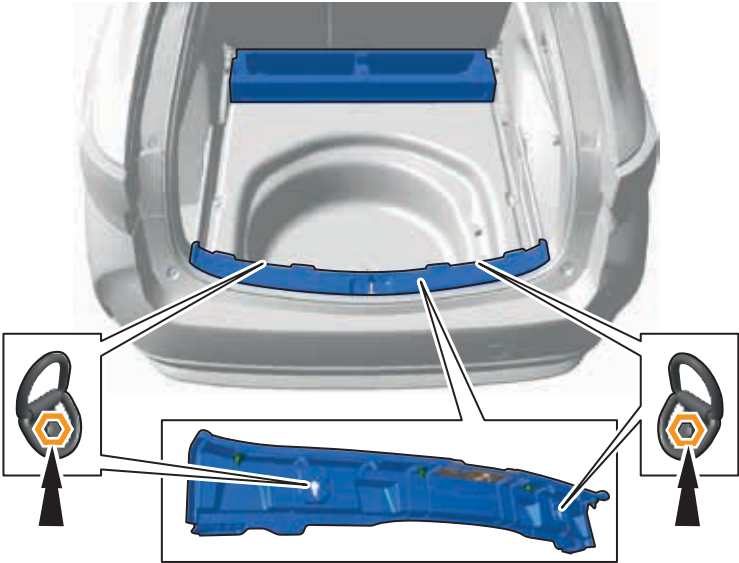
**6 Nm**       

**8**

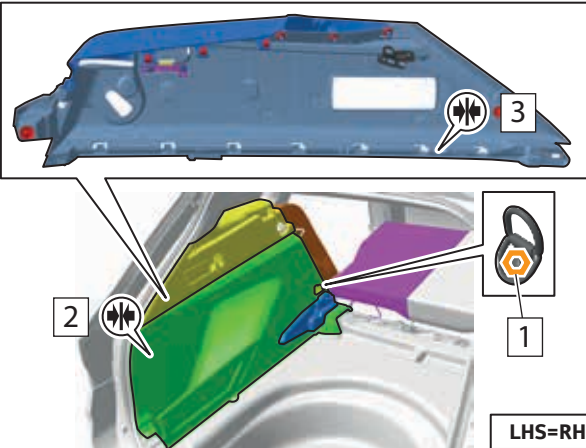

LHS=RHS

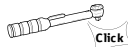
1→2→3		<b>A</b>
1	6Nm 1x	<input type="text"/>
2	OK	<input type="text"/>
3	OK	<input type="text"/>

**AFTER INSTALLATION**

**1**



**Serial Number**

**5,4 Nm**

**2**

**1** **2** **3** **4** **5** **6**

**3**

**7 Pin**

**1** **2** **3** **4** **5** **6** **7**

---

**13 Pin**

**1** **2** **3** **4** **5** **6** **7** **8** **9** **10** **11** **12** **13**

**4**

**5**

**6**

ENGINE START STOP

PUSH

6 Sec.

ON OFF

A

B

**7**

OFF

ON

OFF

**8**

R 1 3 5  
2 4 6

**9**

1

2

3

FAILURE TEST FUNCTION

TESTER

Beeeeeeep

**10**

**11**

Model Year: XXXXXXXXXX  
Towing hitch with  
harness 7-pin (1.5 pin)

factory

VEHICLE OWNERS MANUAL

**12**

= OK

= OK

**13**

DIAGNOSTIC TOOL

NO DTC=OK

**14**

1

**15**

= OK

**16**

= OK

**Installation Date:**  
. . / . . / . . . .

**Technician Name & Signature:**

**Stamp:**

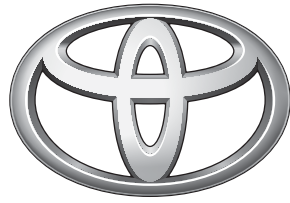

**TOYOTA**



# OWNER'S MANUAL

Model /Year

Corolla (TS & 2.0L )  
2019/02

Towbar wiring kit 13-pin  
Towbar wiring kit 7-pin

