



TOYOTA

ALWAYS A
BETTER WAY

Corolla (HB)

Front & rear set mudflaps

Installation instructions

Model year: 2019/01
Vehicle code: **E*1**-*-*H****
Part number: 53008-02050

Manual reference number: AIM 004 353 - 1

Revision Record

Rev. No.	Date	Page	Picture	Update	New	Deleted steps
1	14.11.18	4, 7-9	4, 5, 11, 12	X		

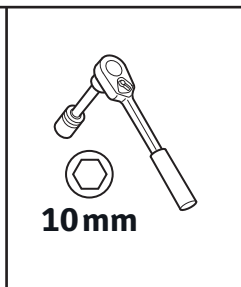
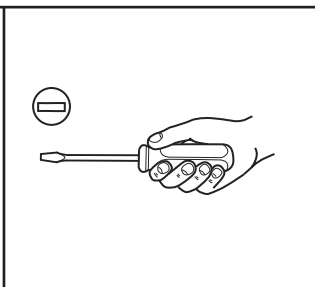
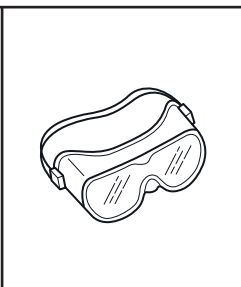
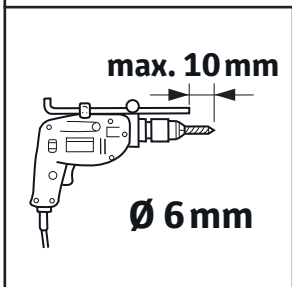
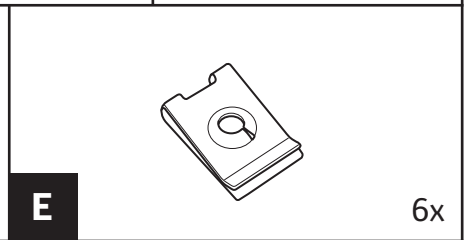
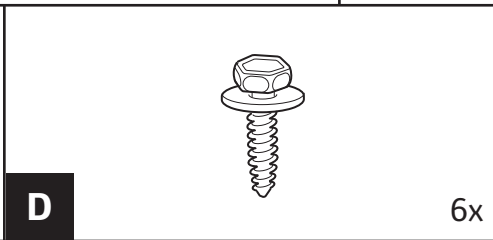
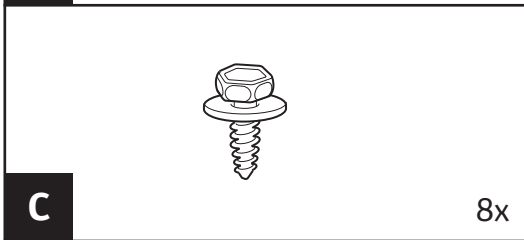
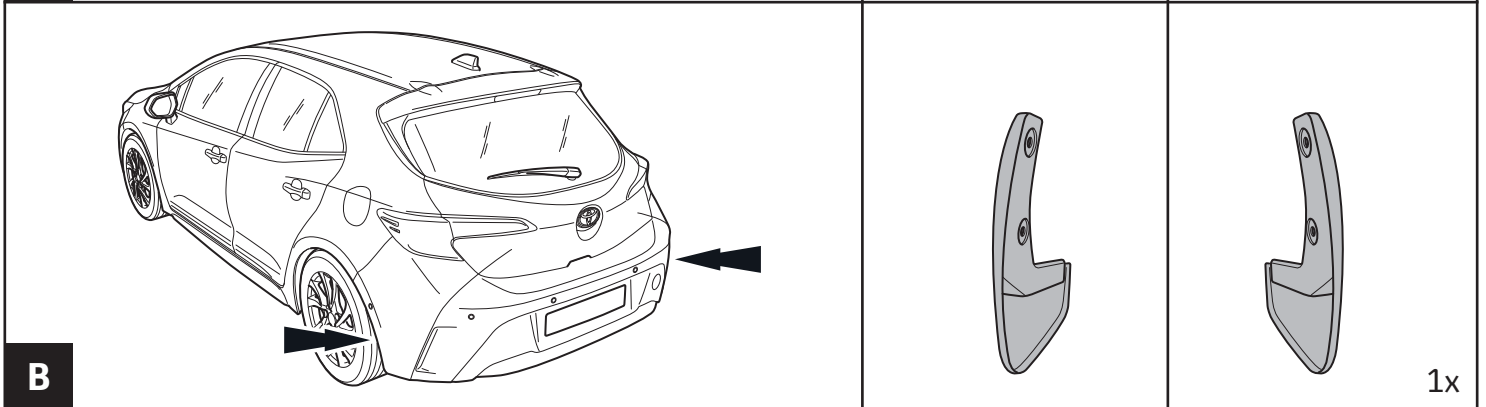
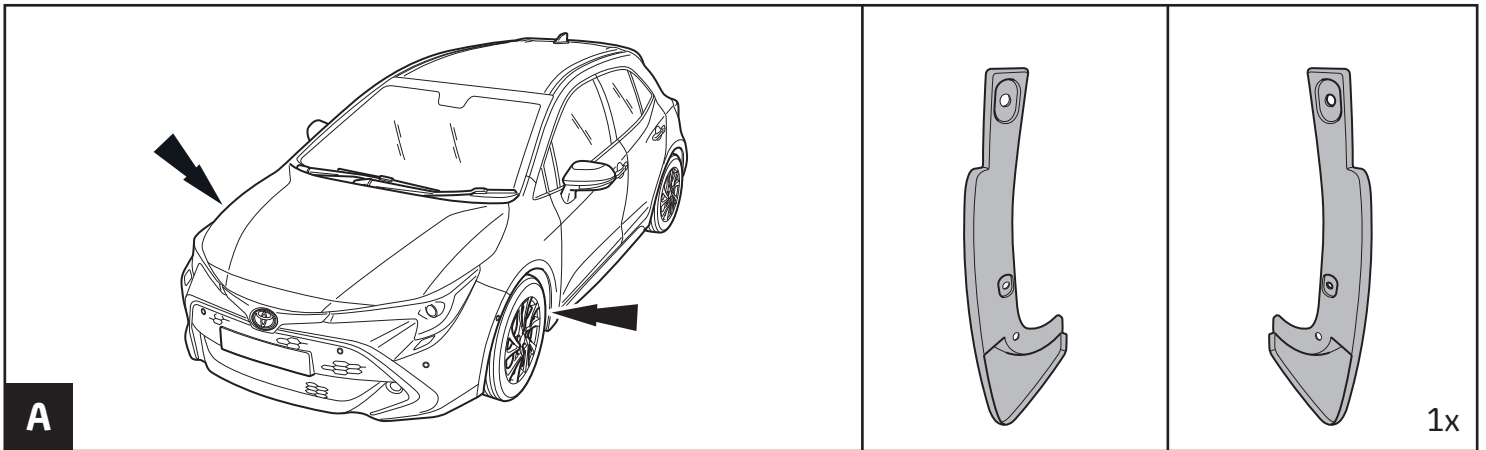

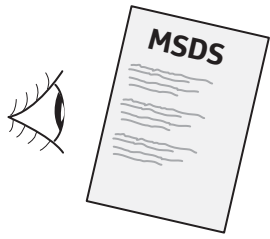

Material Safety Data Sheet

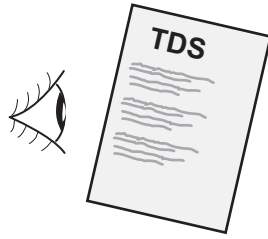

Technical Data Sheet

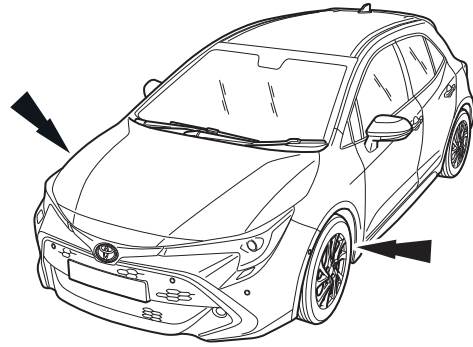
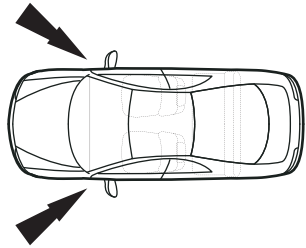
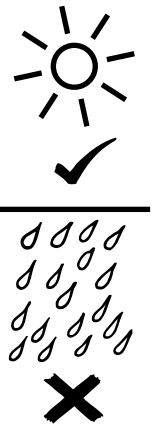

1

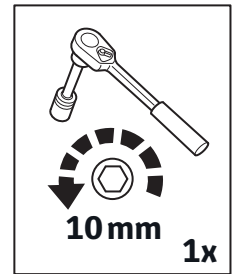
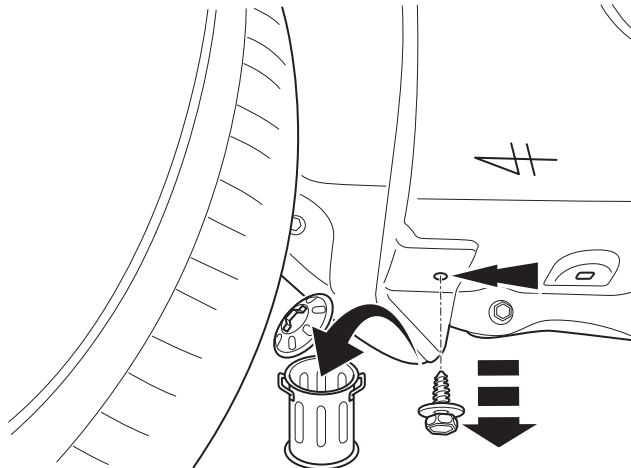
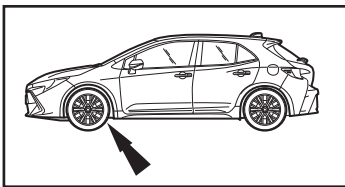

2

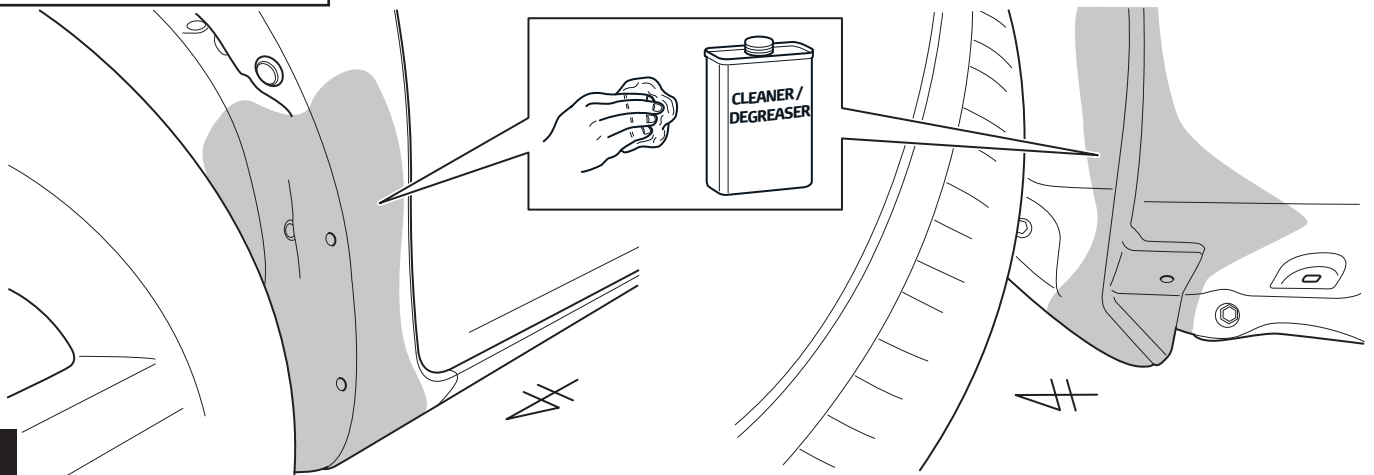
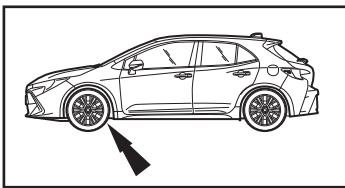

3

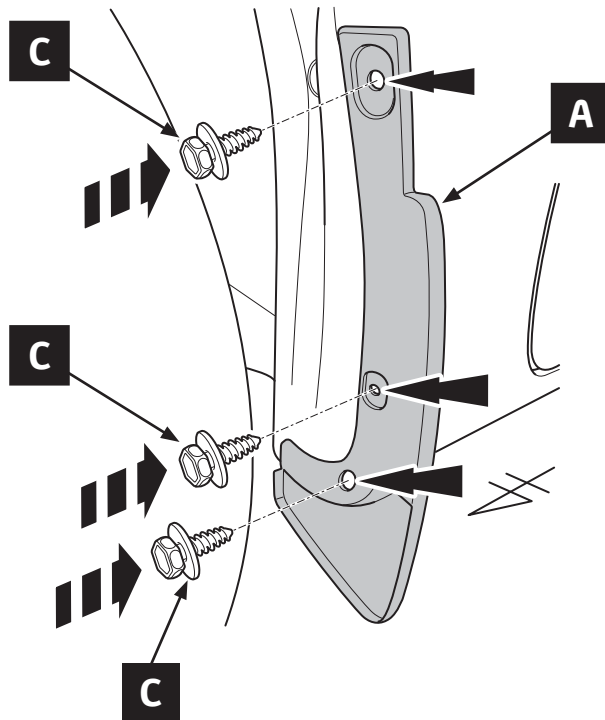
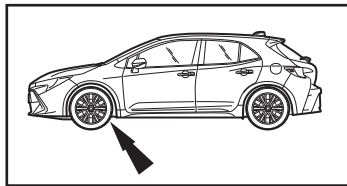

4

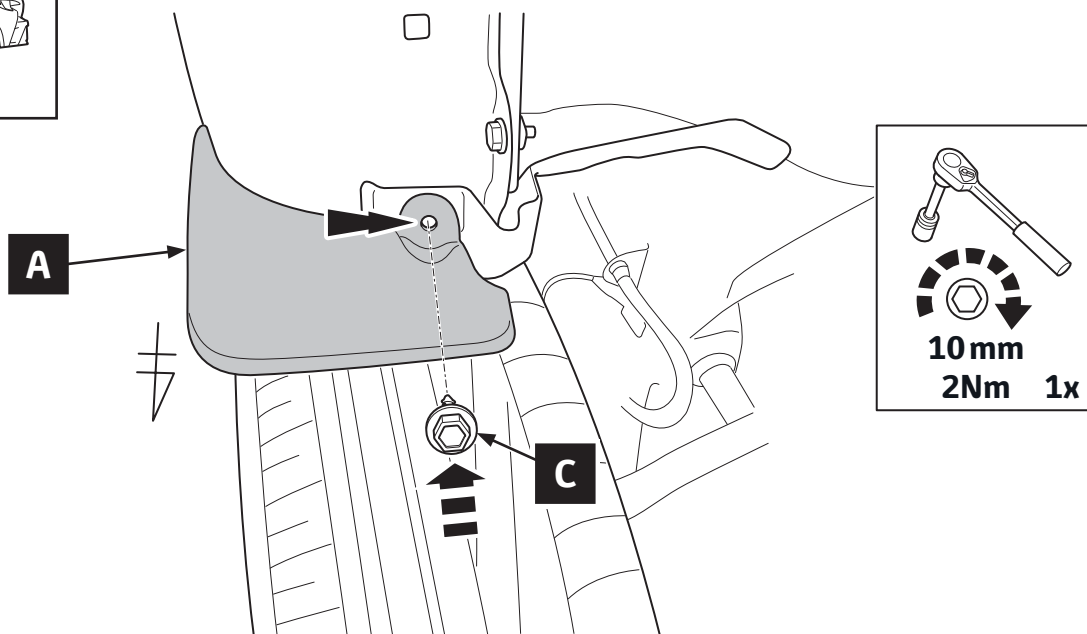
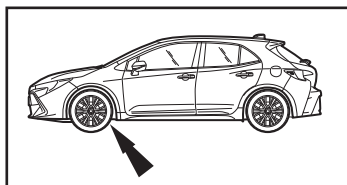

5

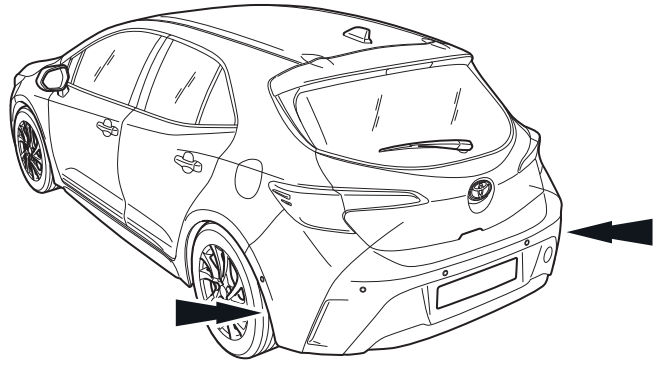
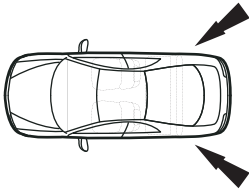

6

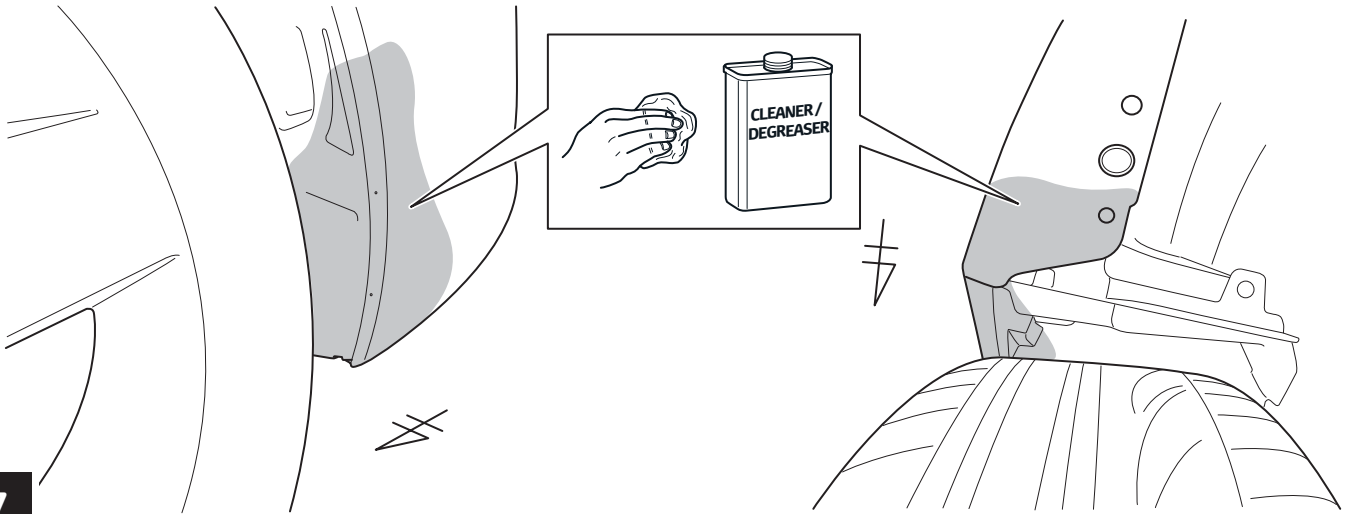
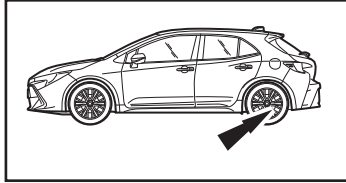

7

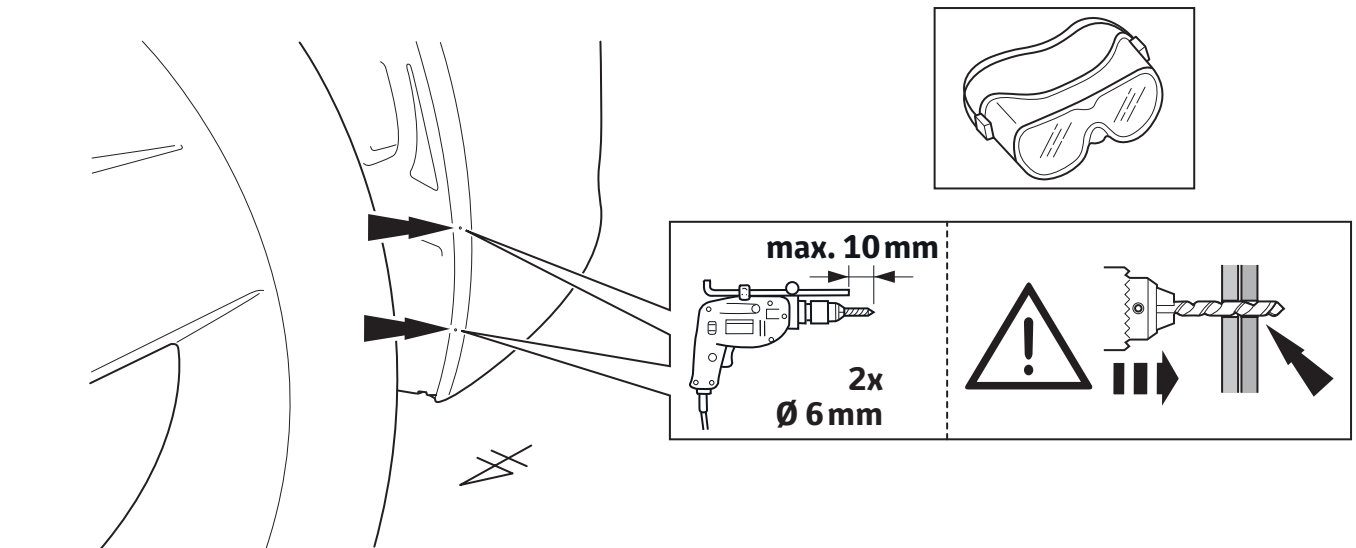
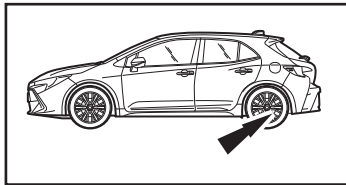

8

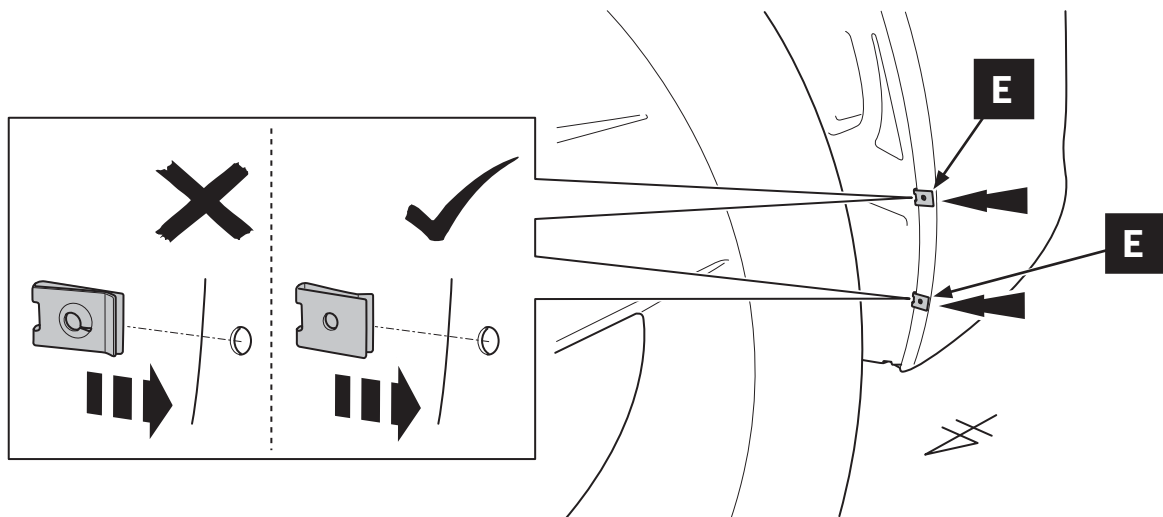
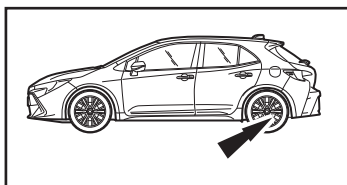

9

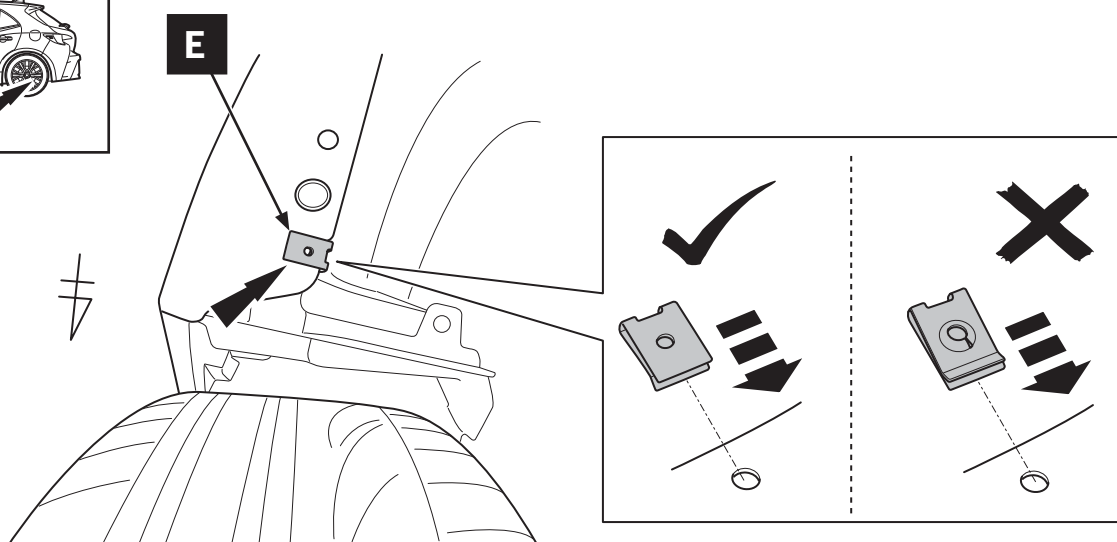
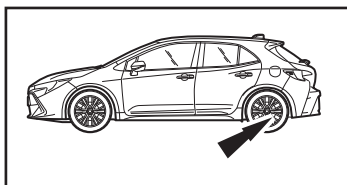

10

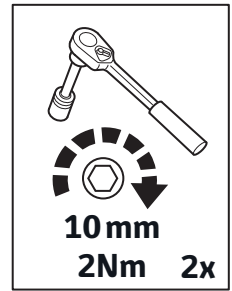
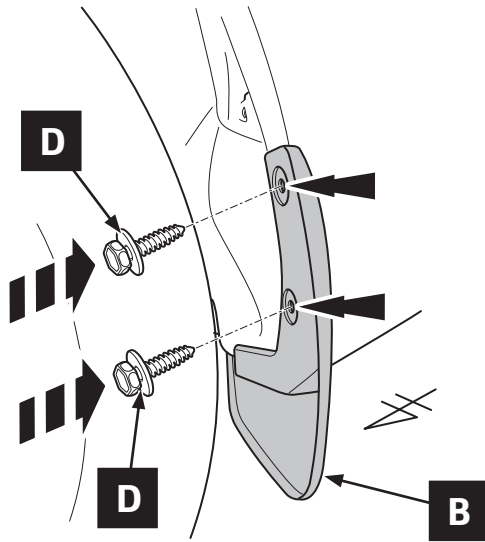
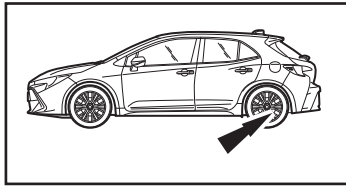

11

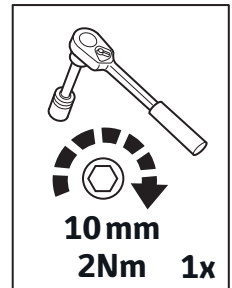
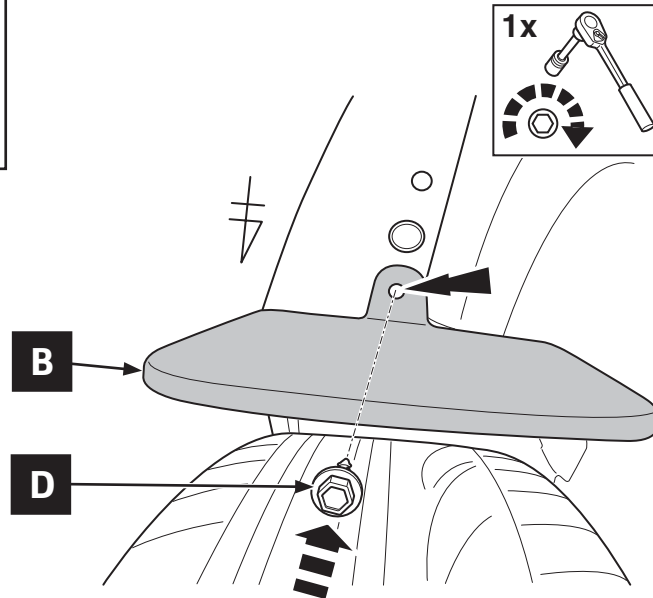
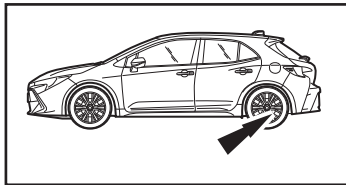

12

INFO



LHS

=



RHS

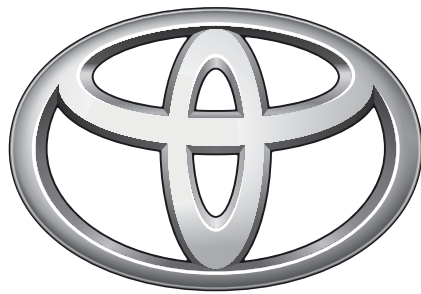

TOYOTA

CHECK SHEET



TOYOTA

Model / Year Corolla (HB)
2019/01

**Mud Flaps - Front
& Rear**

VIN n°

ALWAYS A
BETTER WAY

P/N = OK

LHS = RHS

2 Nm

Serial Number

LHS = RHS

2 Nm

Serial Number

= OK

Installation Date:
... / ... / ...

Technician Name & Signature:

Stamp: