



**TOYOTA**

ALWAYS A  
BETTER WAY

# Corolla (TS)

## Rear lower trunk garnish

Installation Instruction

Model year: 2019/02

Vehicle code: \*\*E\*1\*\*-DW\*\*\*W

Part number: PW405-02003-01  
PW405-02003-24  
PW405-02003-CA  
PW405-02003-DJ

Manual reference number: AIM 004 302 - 1

# Revision Record

Rev. No.	Date	Page	Picture	Update	New	Deleted steps
1	08.11.18	3-6, 9	1-3, 5-8	X		

PW405-02003- \*\*



**A**

1x

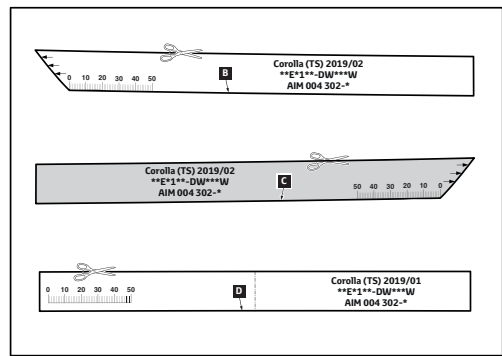
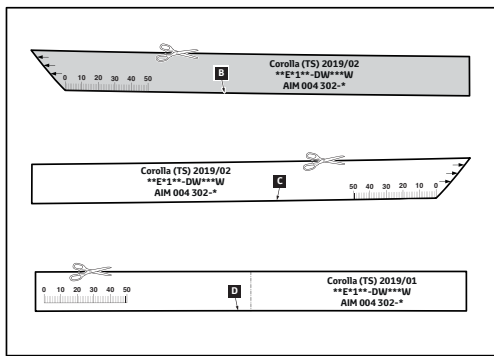

**B**

1x

**C**

1x

**D**

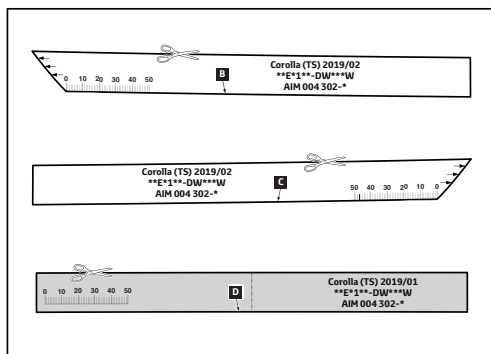

1x

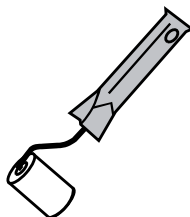
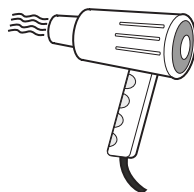
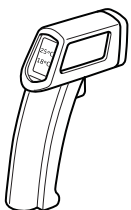

AIM 003-516-\*

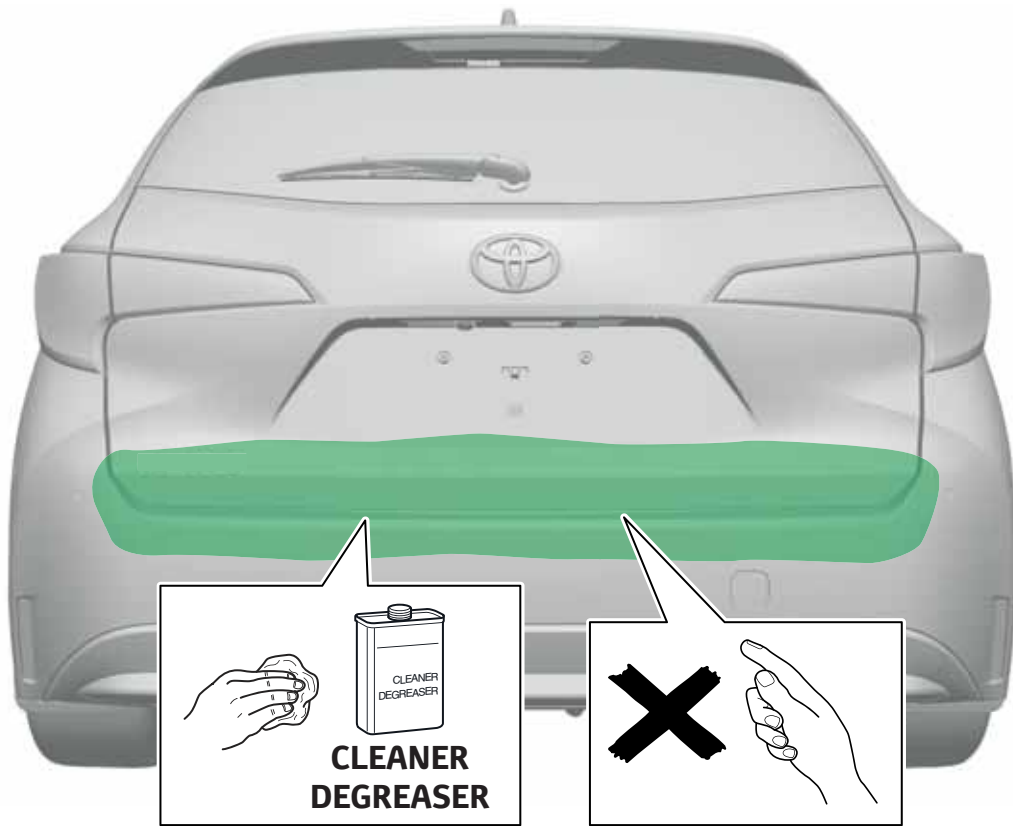

1

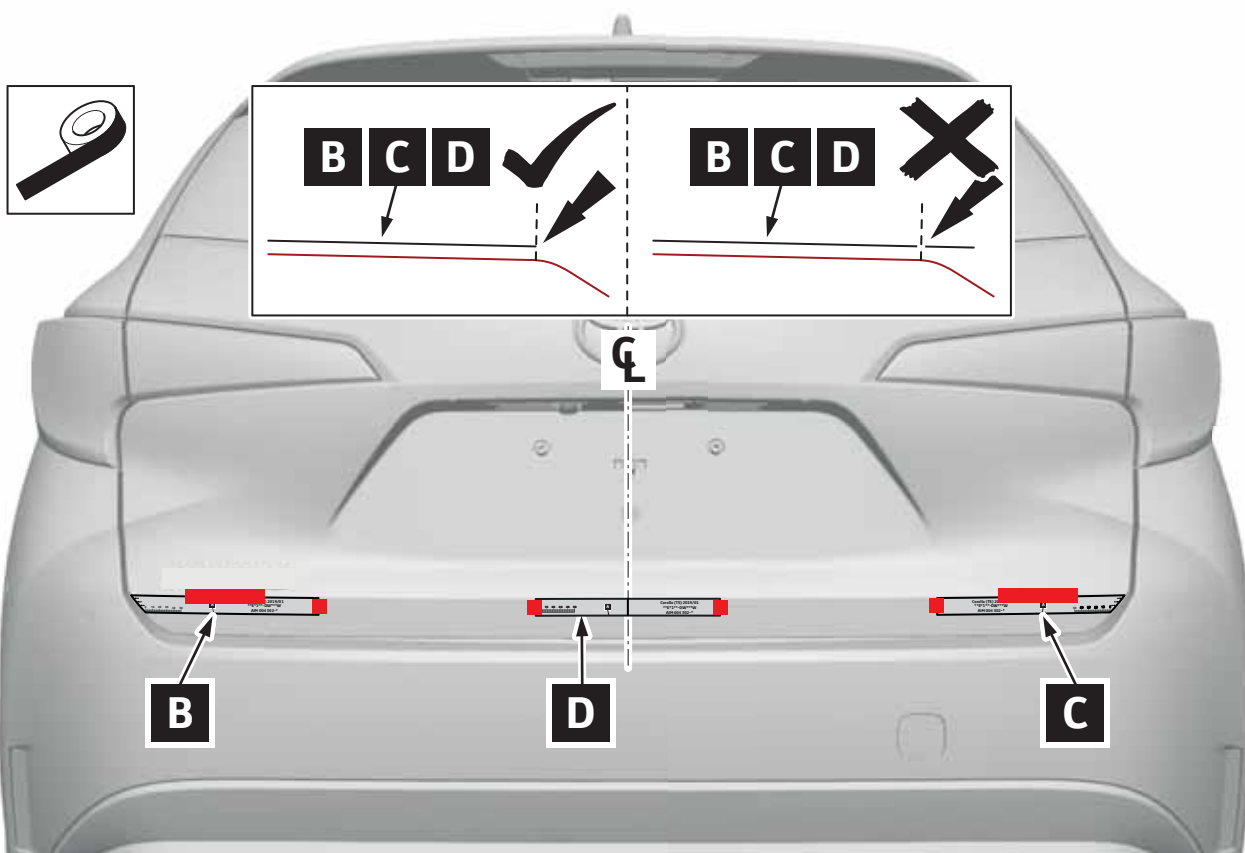

2



<p>1</p>	<p>&lt; 20°C → 2</p> <p>20°C - 40°C → 4</p>	<p>2</p>
<p>3</p>	<p>20°C - 40°C → 4</p>	<p><b>INFO</b></p> <p>3 → 8</p>

3

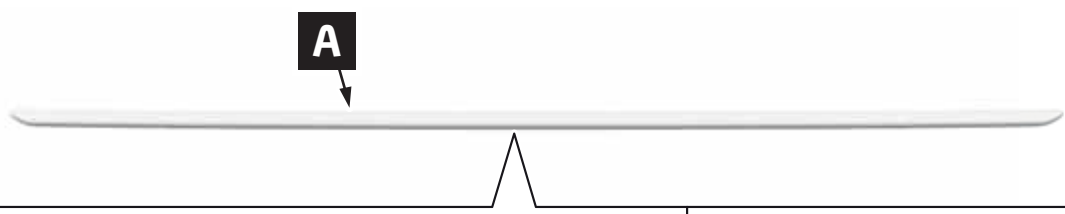

<p>1</p>	<p>&lt; 20°C → 2</p> <p>20°C - 40°C → 5</p>	<p>2</p>
<p>3</p>	<p>20°C - 40°C → 5</p>	<p><b>INFO</b></p> <p>4 → 8</p>

4

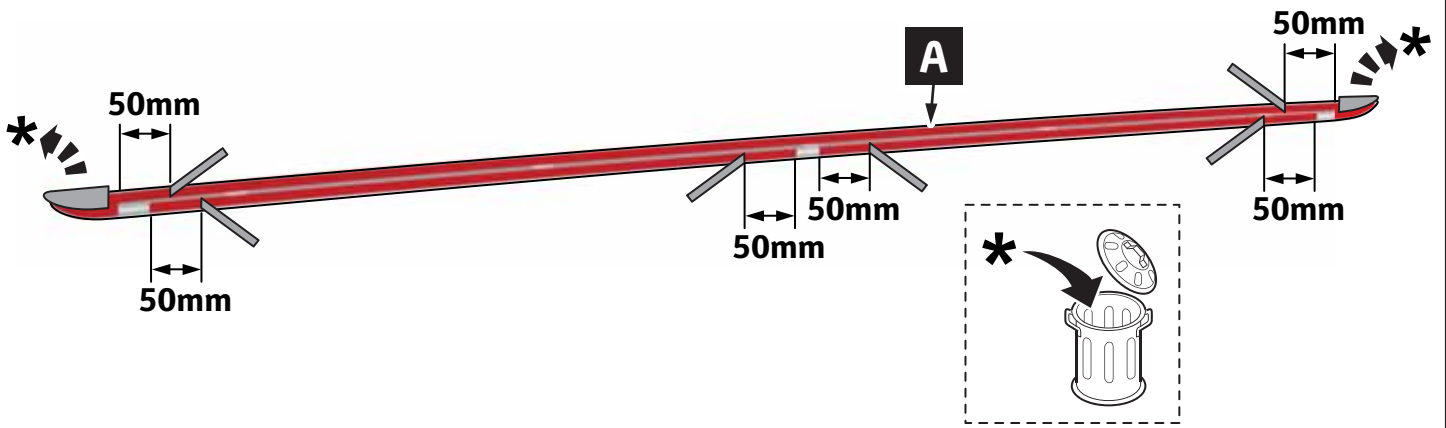

5

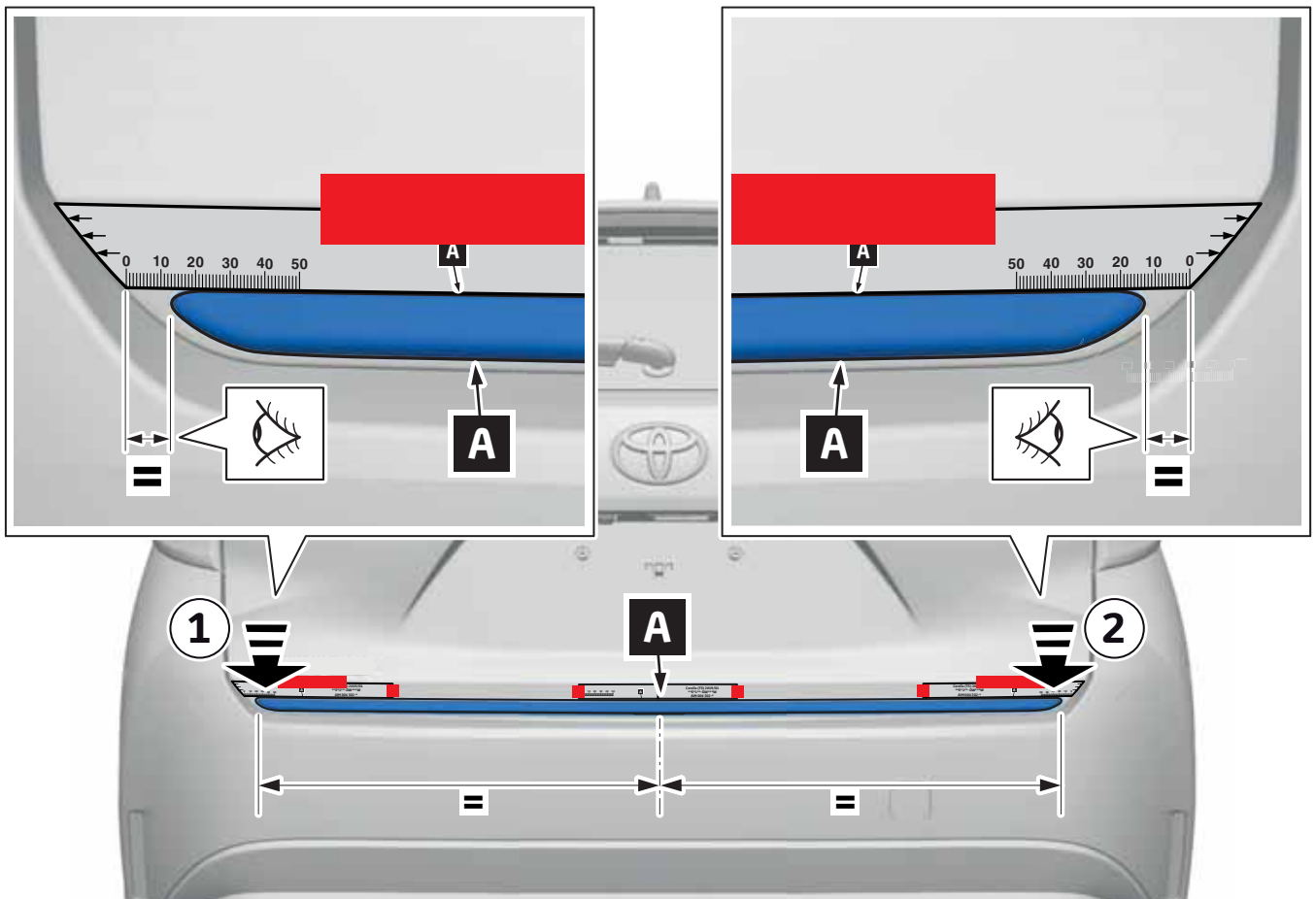

6

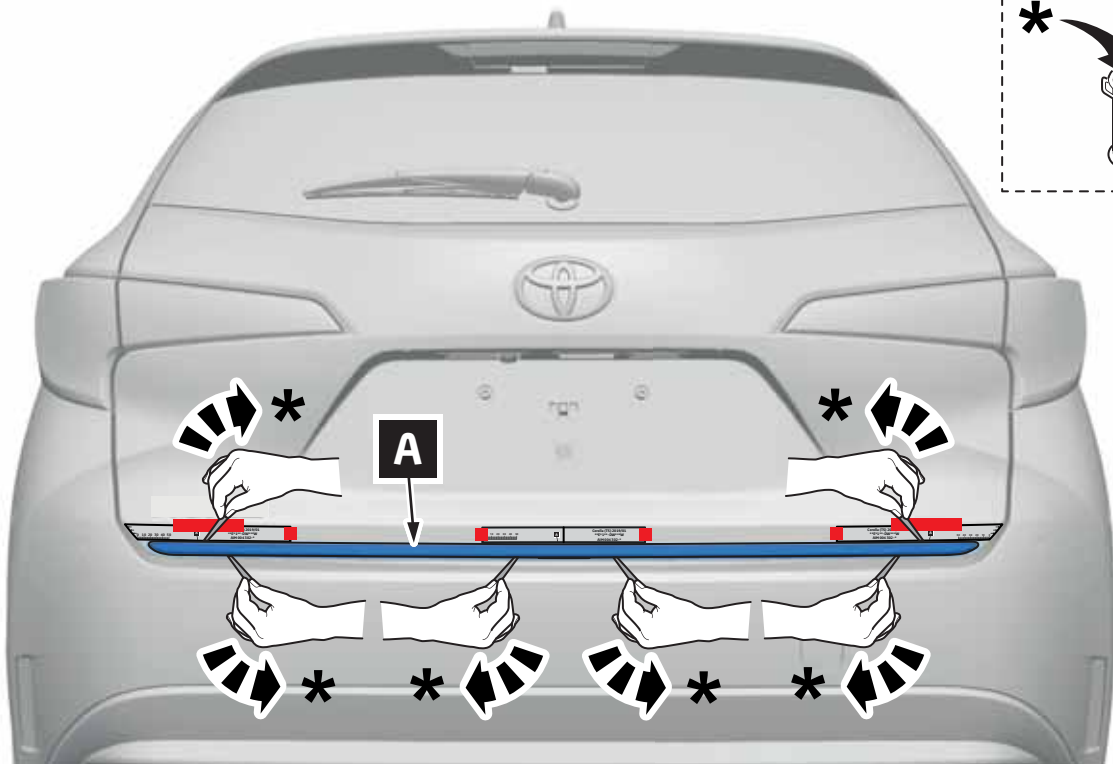

7

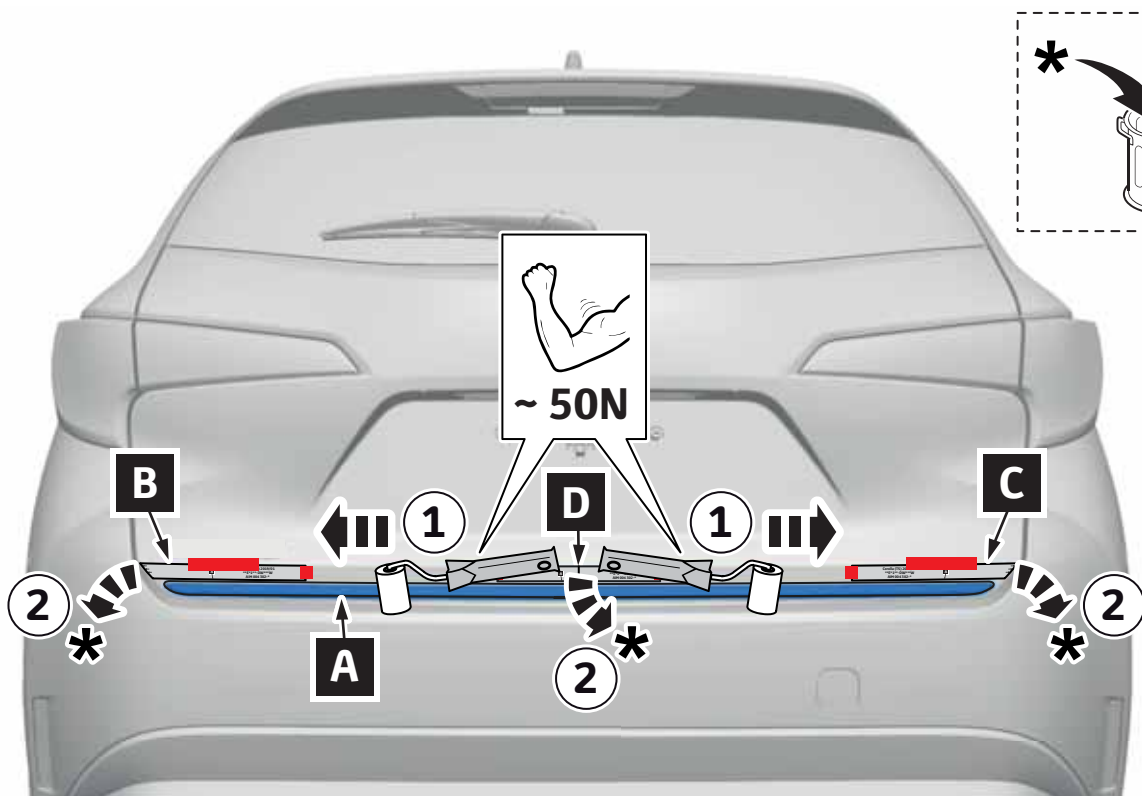

8

# INFO

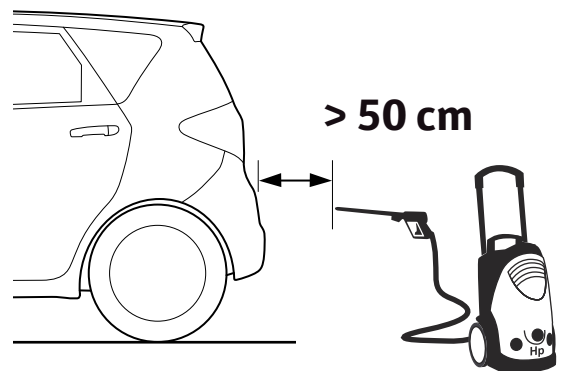
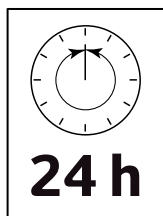
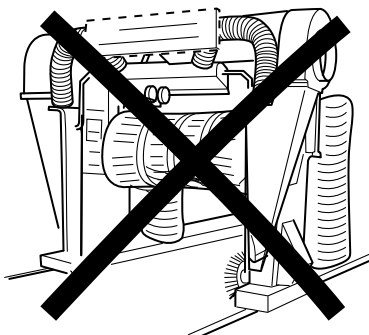
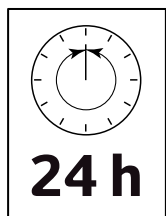

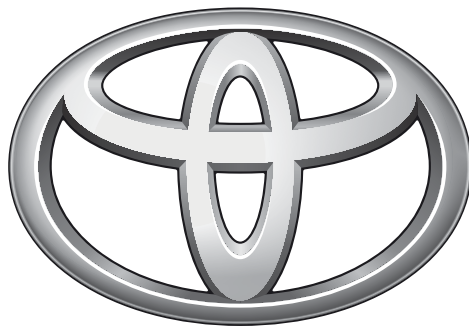

**TOYOTA**



# CHECK SHEET



**TOYOTA**

ALWAYS A BETTER WAY

**Model / Year** Corolla (TS)  
2019/02

**Rear lower  
trunk garnish**

**VIN n°**

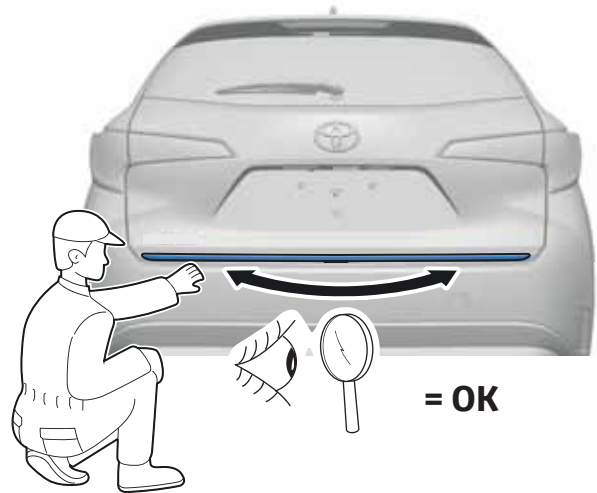
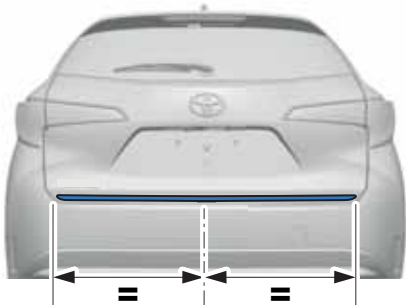
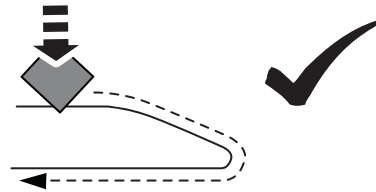
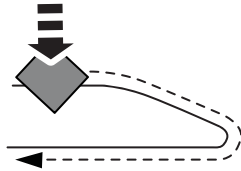
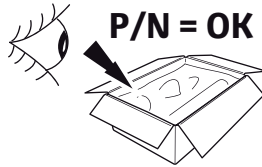

= OK

**Installation Date:**

. . / . . / . . . .

**Technician Name & Signature:**

**Stamp:**