

AYGO X

Side Mouldings

Installation Instructions

Model year: As from 2022/03

Vehicle code: KGB70*-AH**KW

Part number: PW170-0H100

Manual reference number: AIM 006 095-0

Revision record

Rev. No.	Date	Page	Step	Remarks

KIT CONTENT

PW170-0H100



PW170-0H102

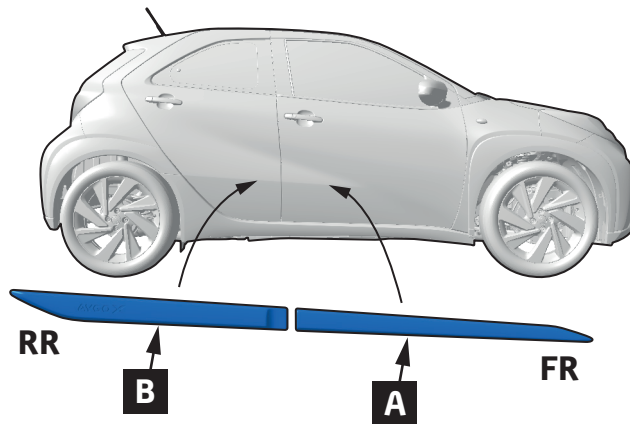

PW170-0H101

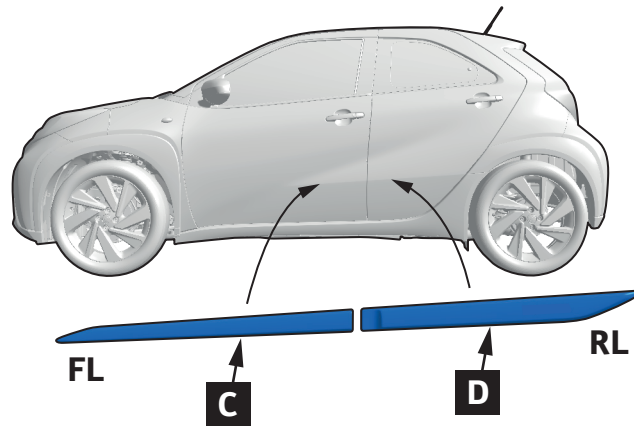

TOOLS & CONSUMABLES & PPE

<p>AIM 003-516-*</p>		<p>50N</p>	<p>Masking Tape</p>
		<p>+ °C</p>	<p>? °C</p>

INFORMATION



Material Safety Data Sheet



Technical Data Sheet

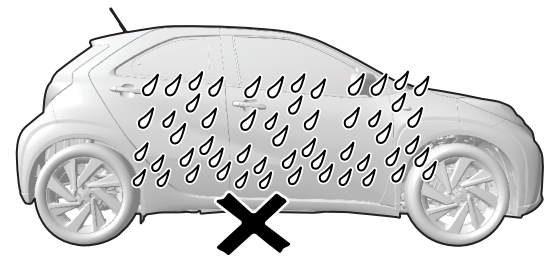
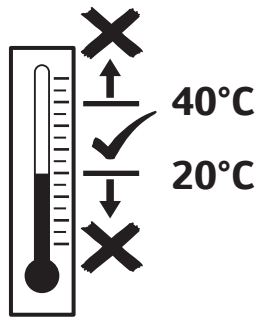
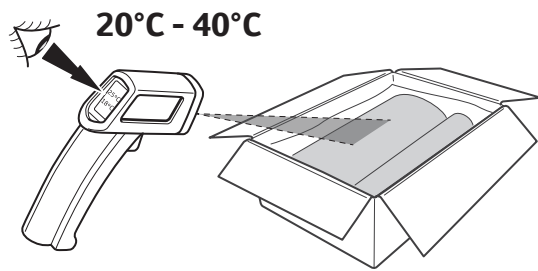
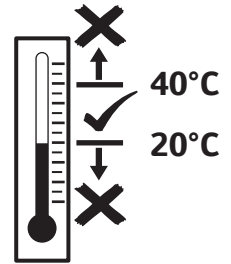
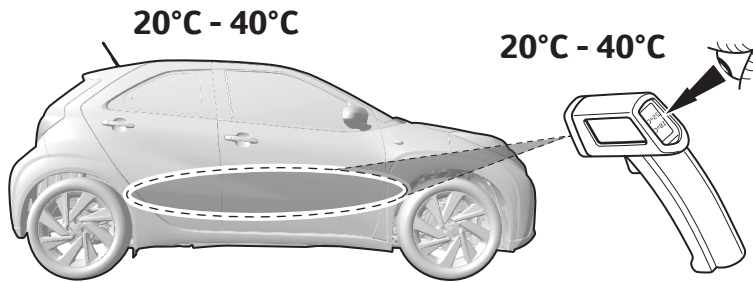

INSTALLATION INSTRUCTIONS

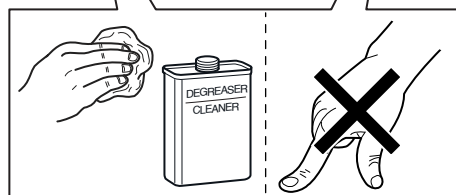
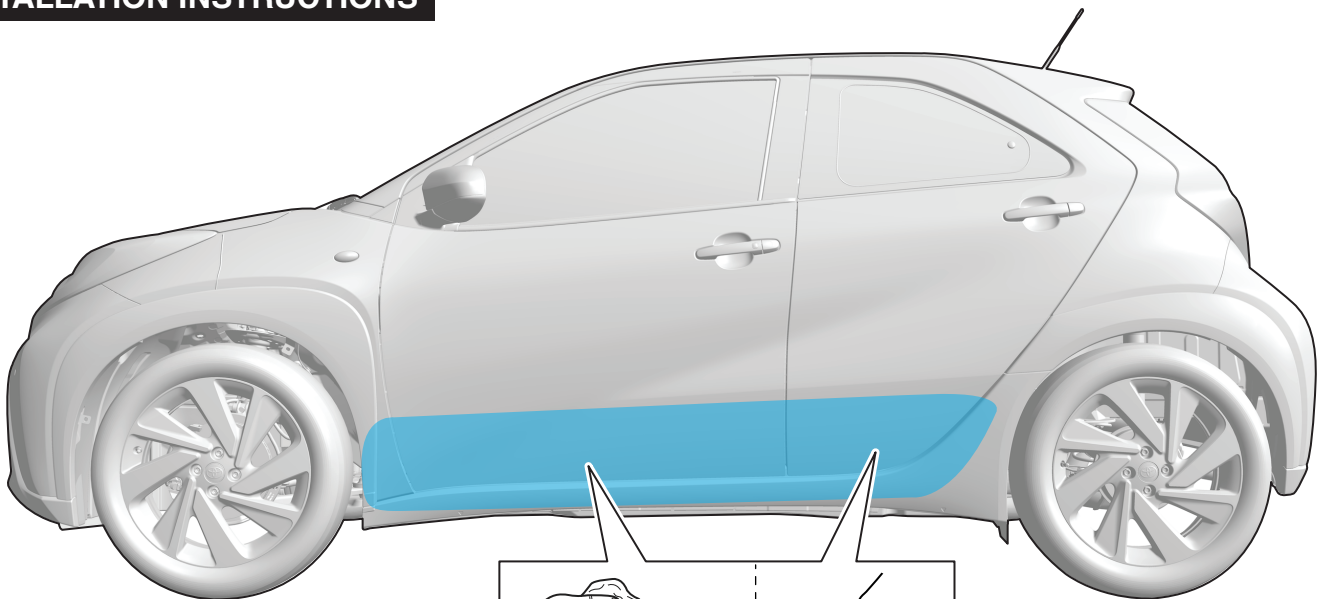

1

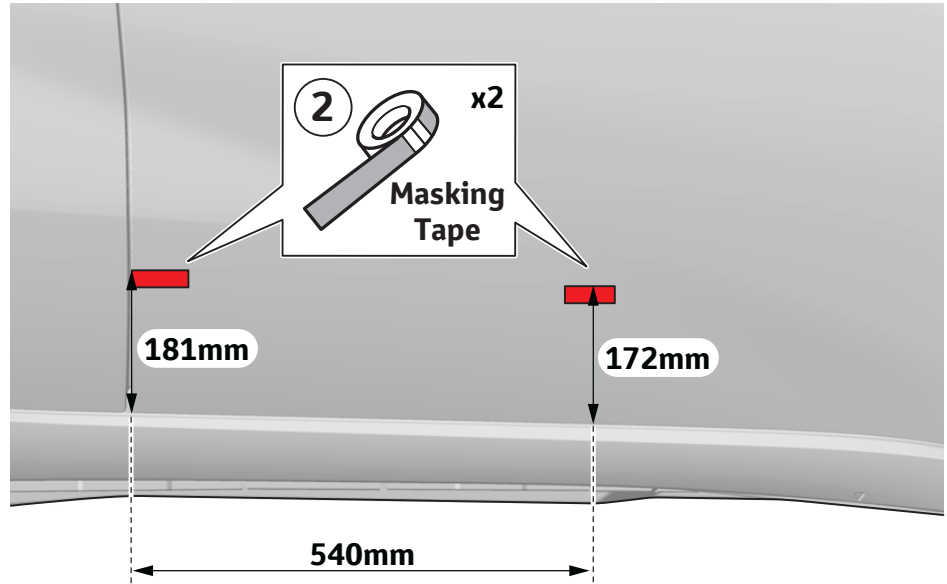
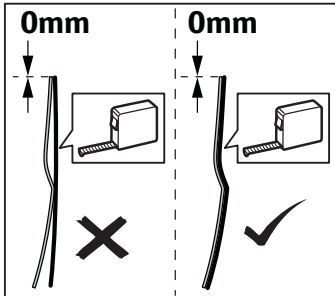
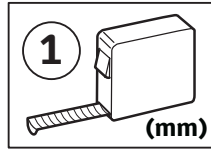
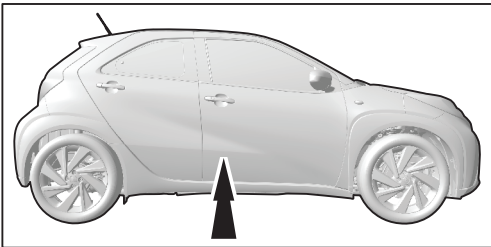

2

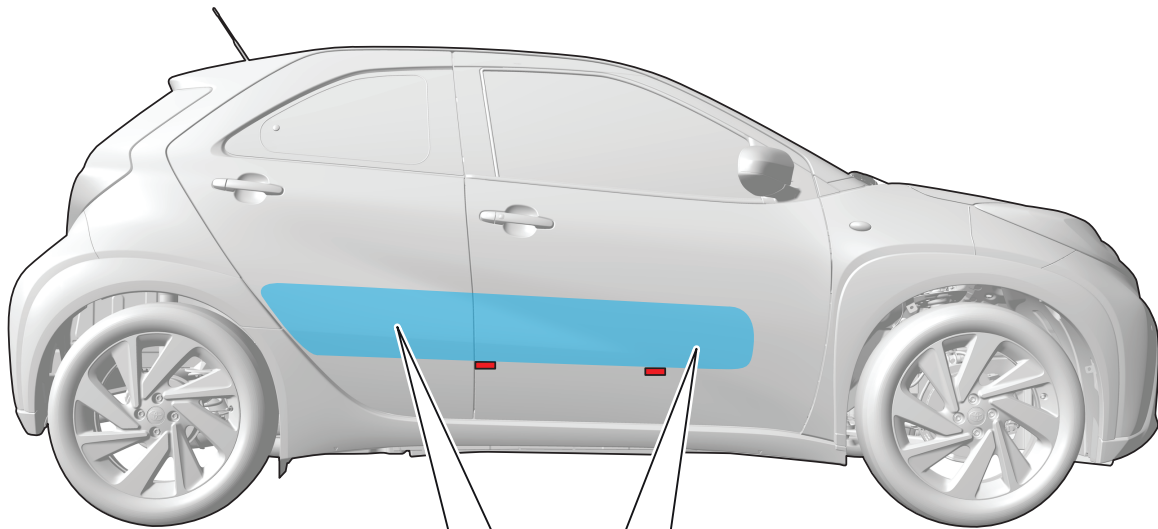

<p>1</p>	<p>? °C</p> <p>< 20°C → 2</p> <p>20°C - 40°C → 4</p>	<p>2</p> <p>+ °C</p>
<p>3</p>	<p>? °C</p> <p>20°C - 40°C → 4</p>	<p>INFO</p> <p> 3 → 12</p> <p> ✓</p> <p> ✗</p>

3

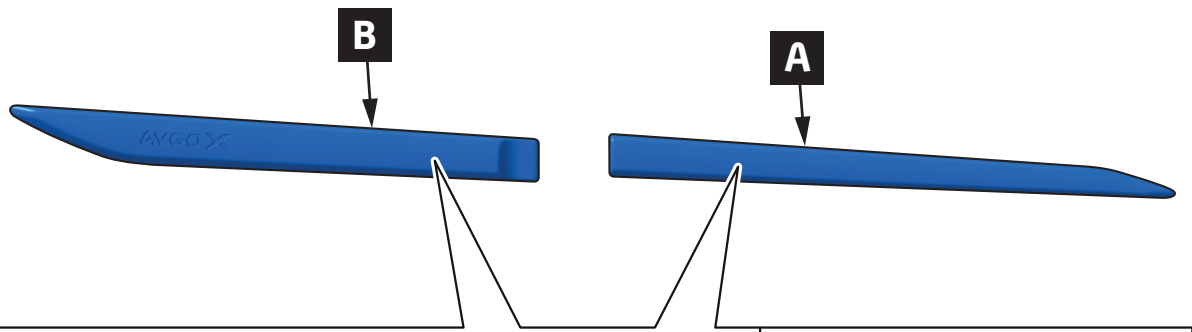

<p>1</p>	<p>< 20°C → 2</p> <p>20°C - 40°C → 4</p>	<p>2</p>
<p>3</p>	<p>20°C - 40°C → 4</p>	<p>INFO</p>

4

5

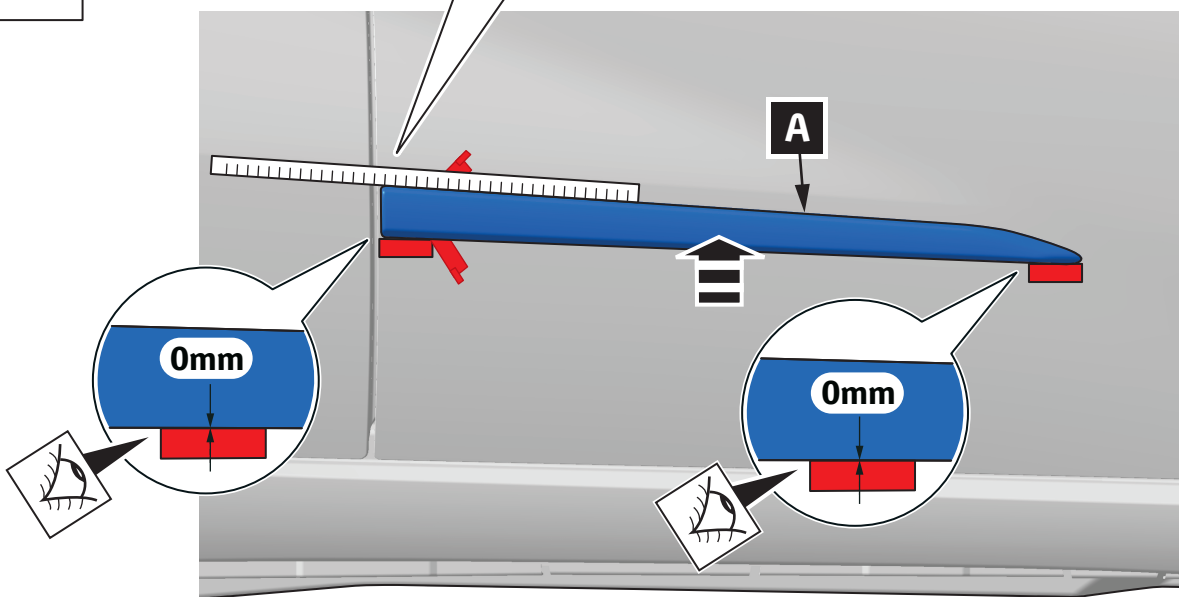
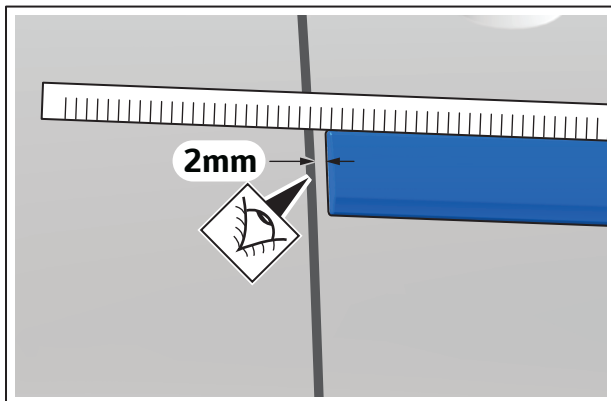
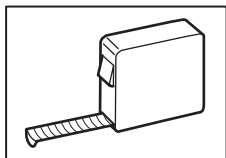
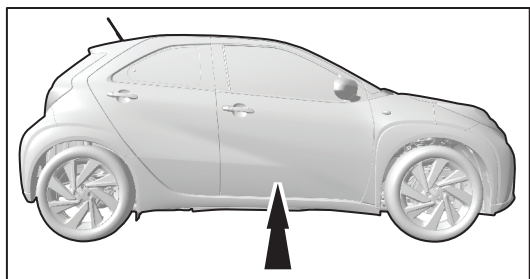

6

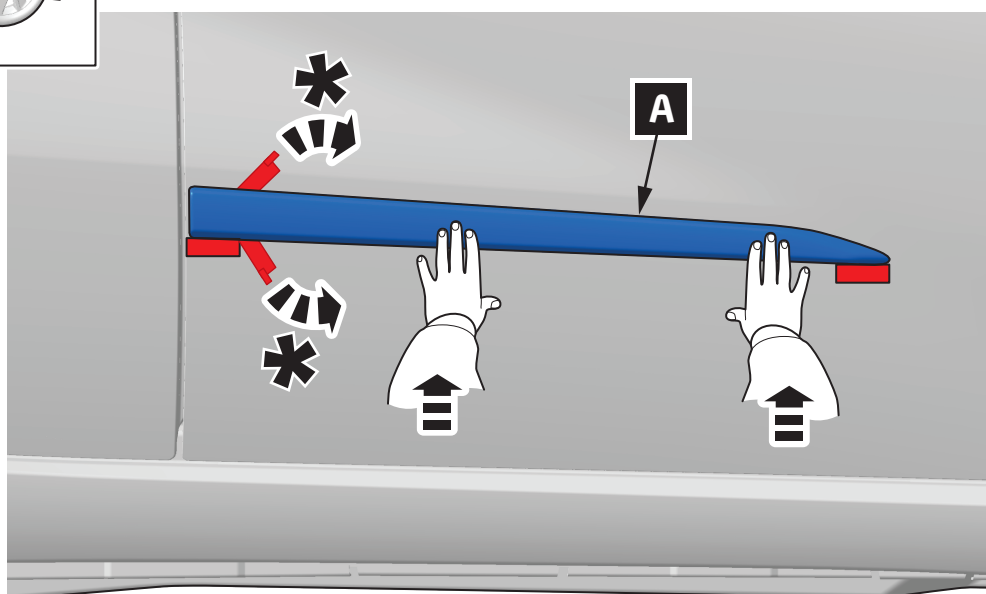
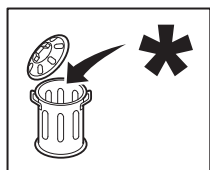
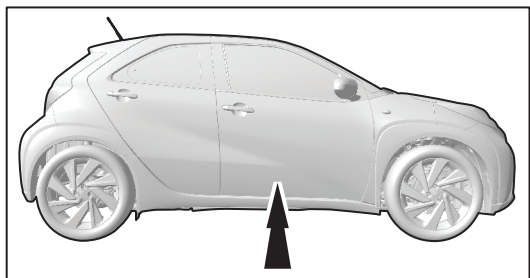

7

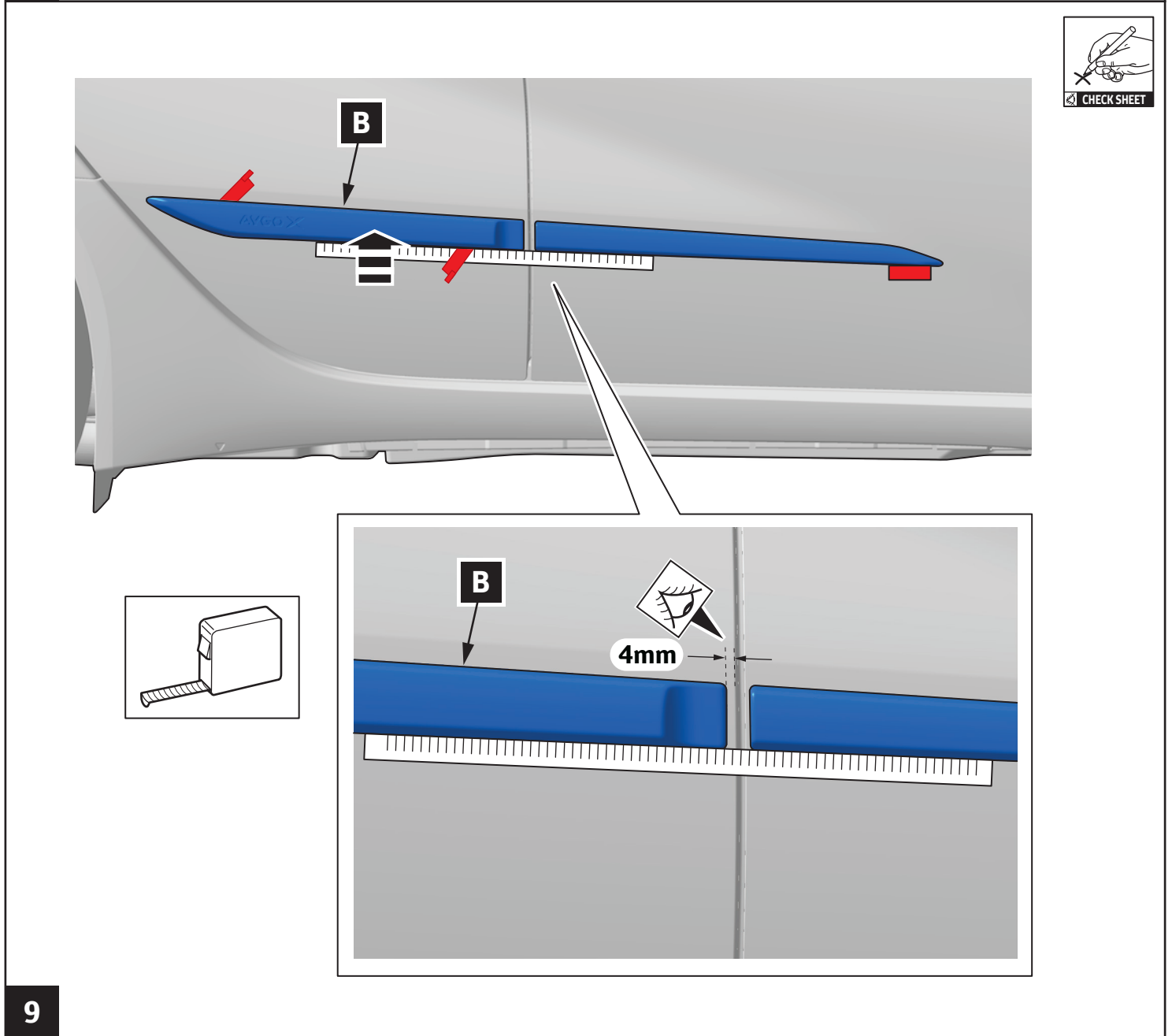
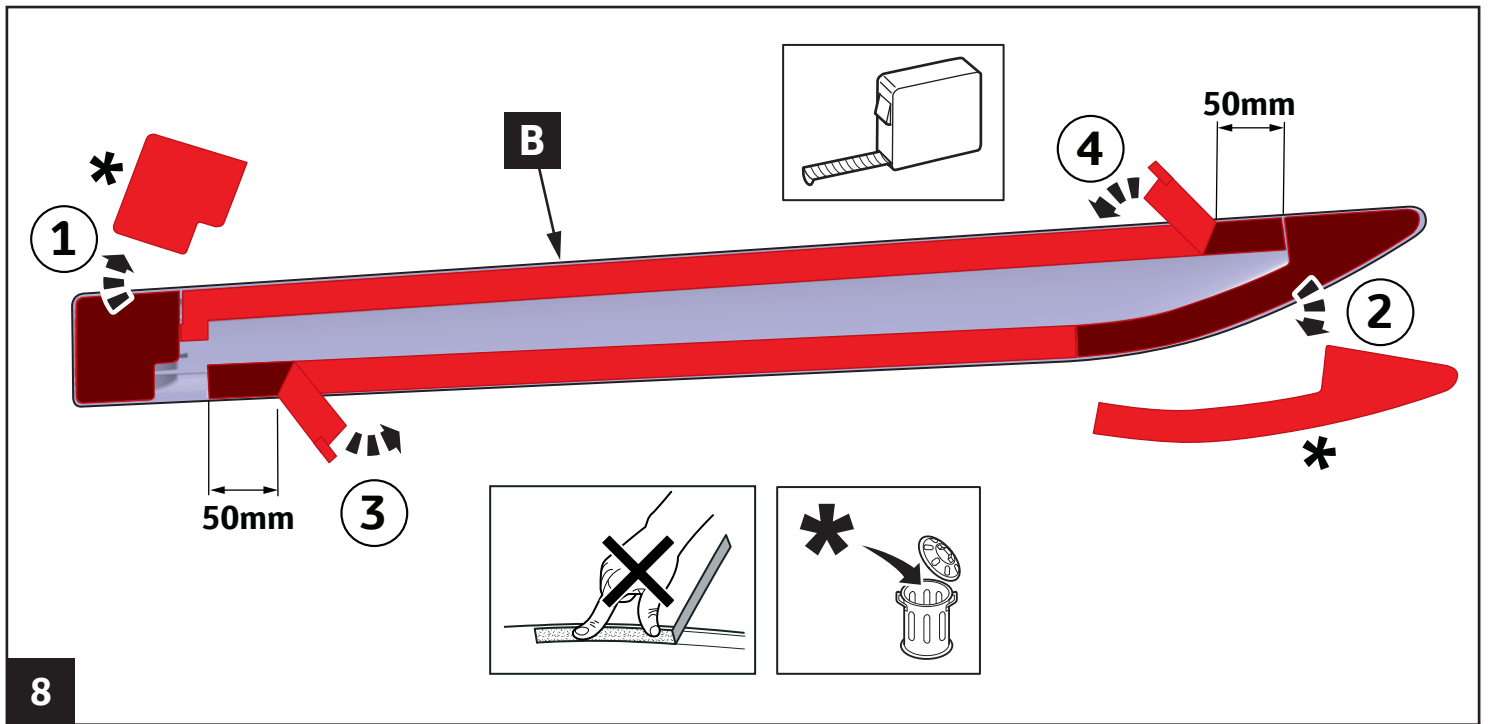

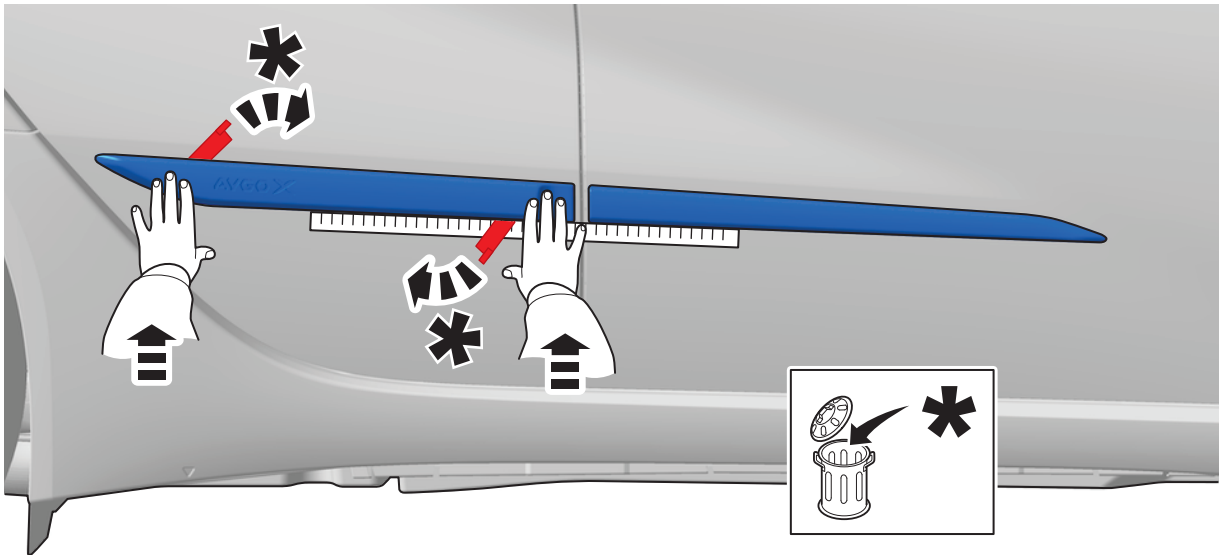

10

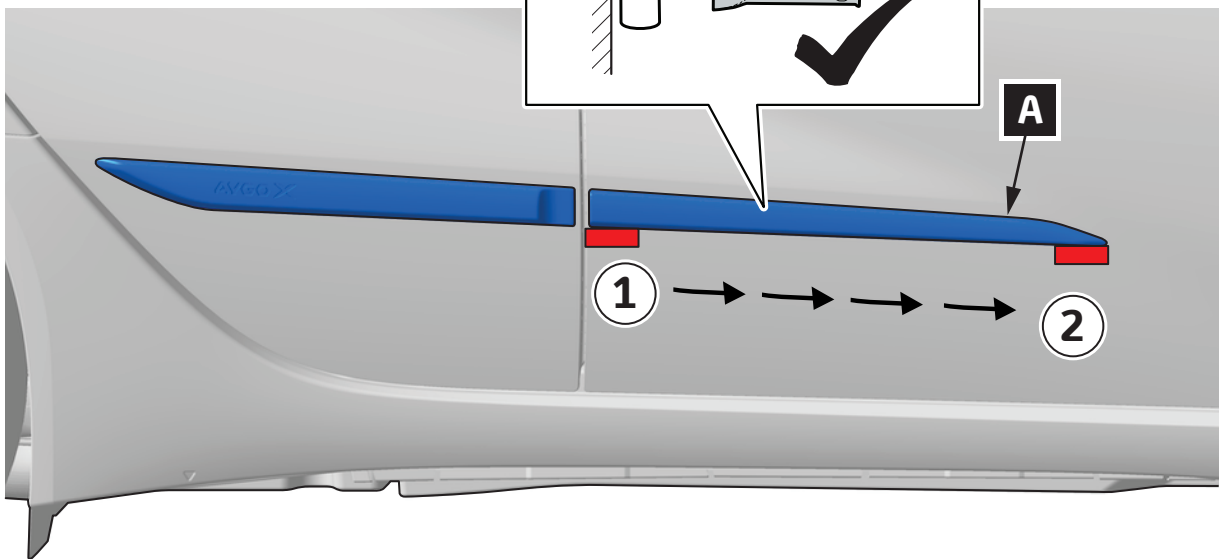
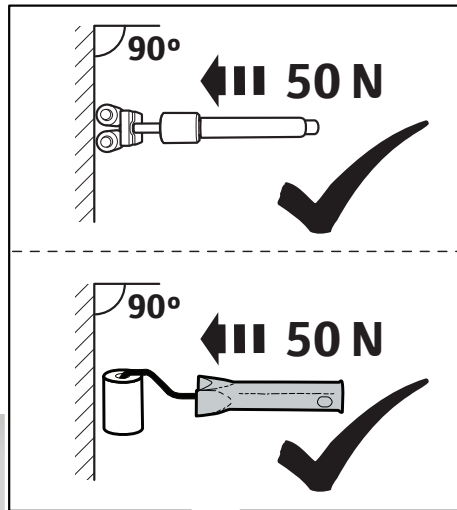
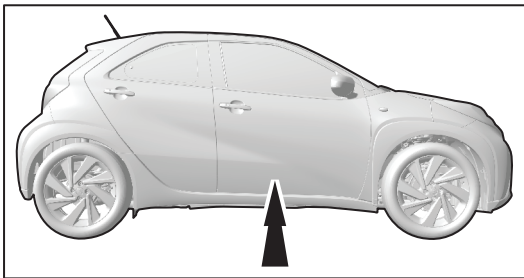

11

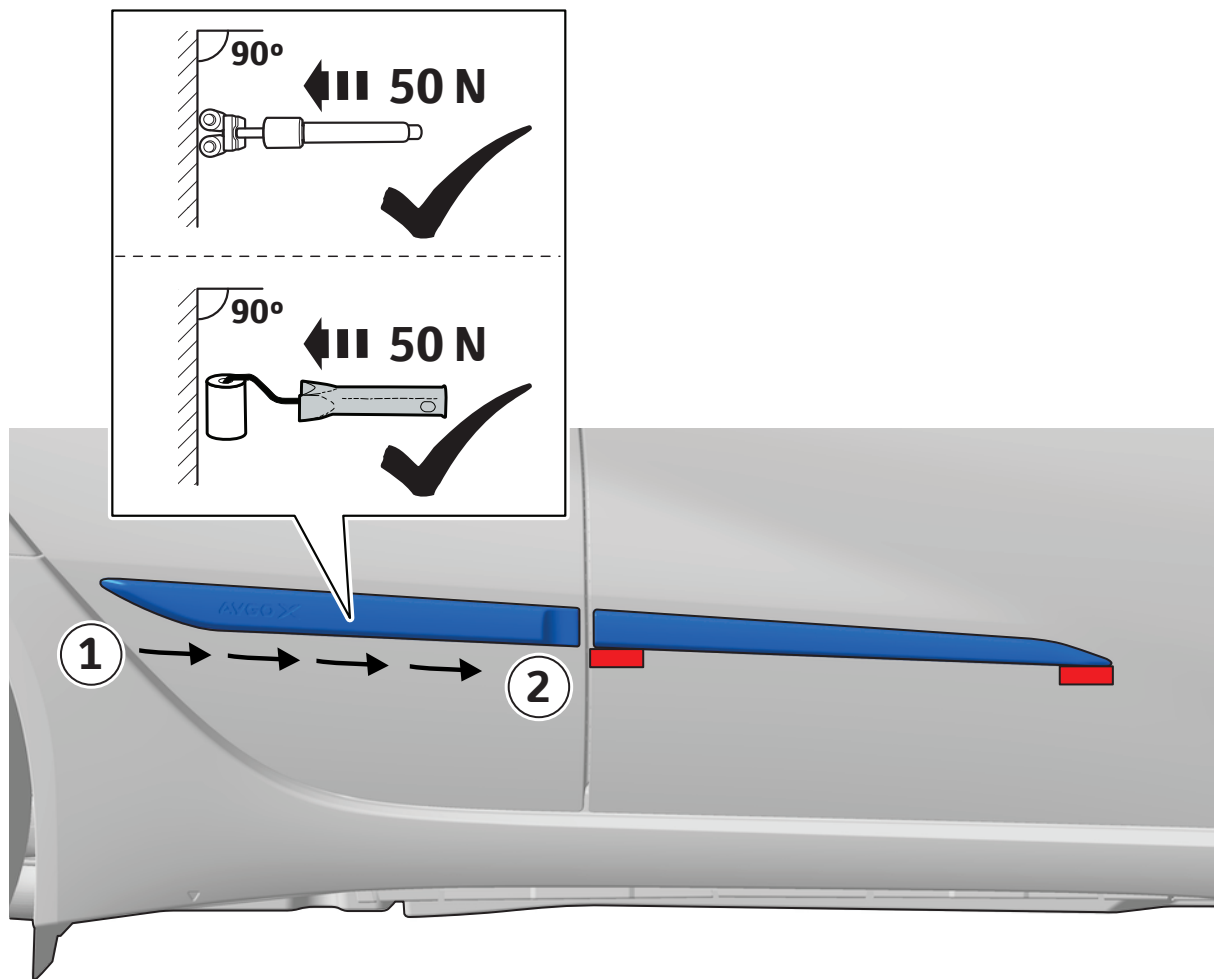

12

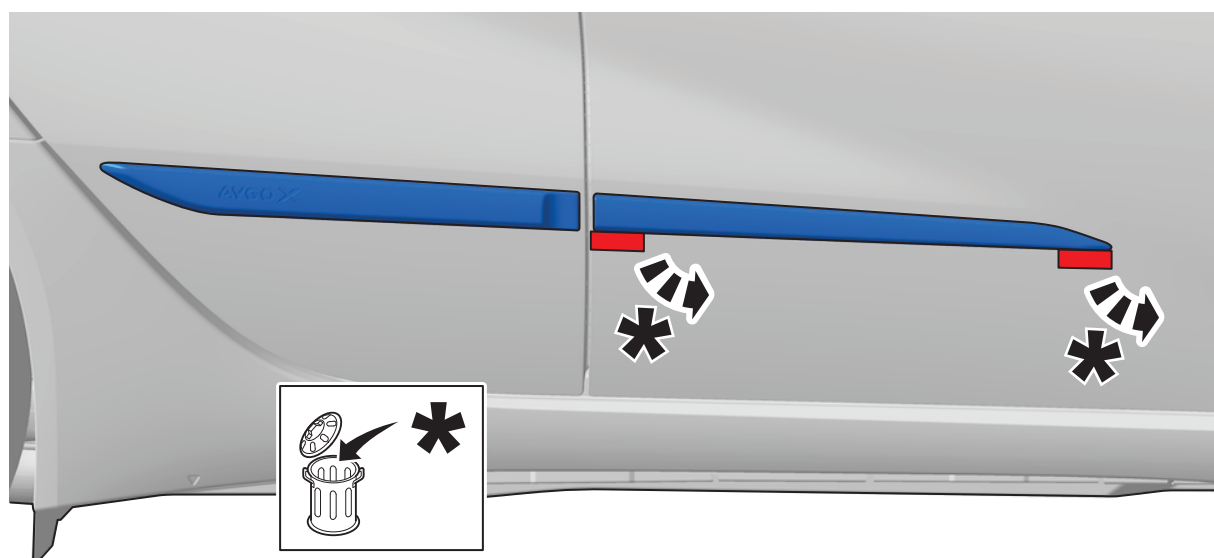

13

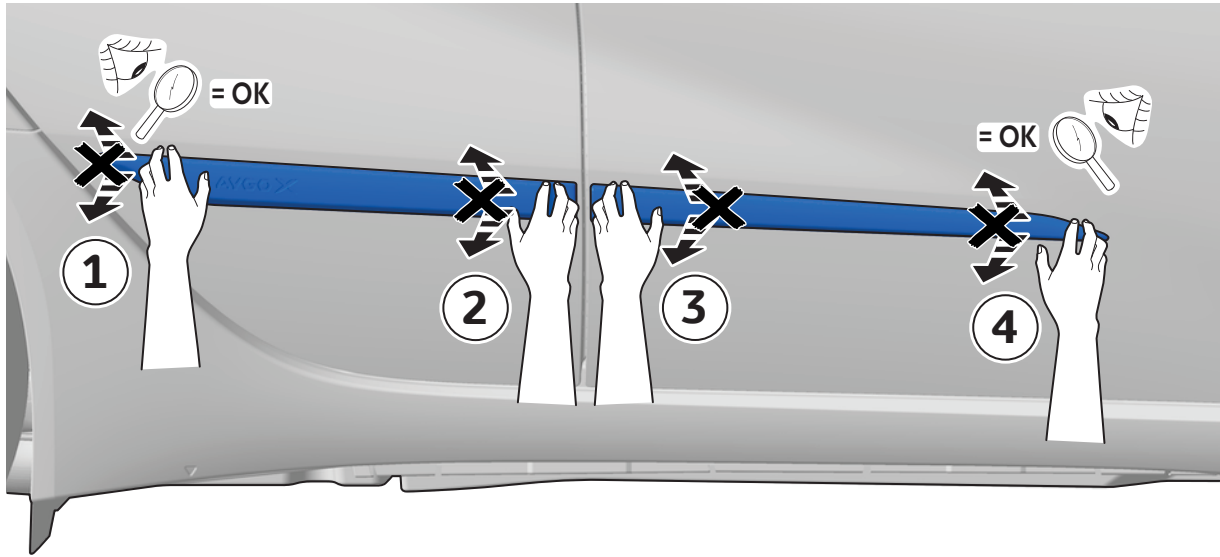

14

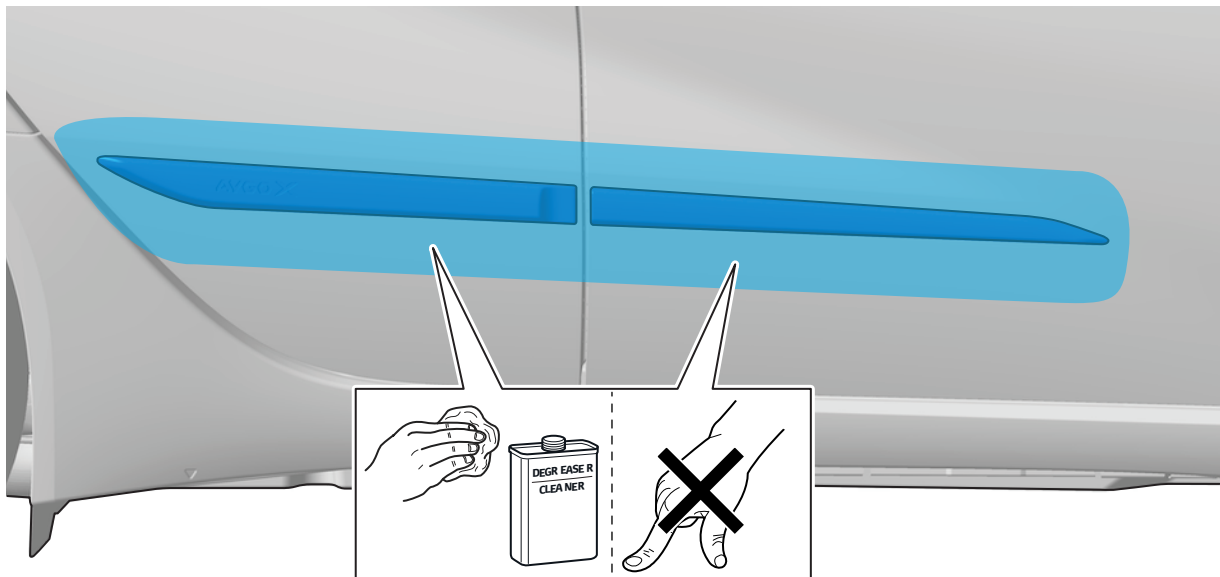

15

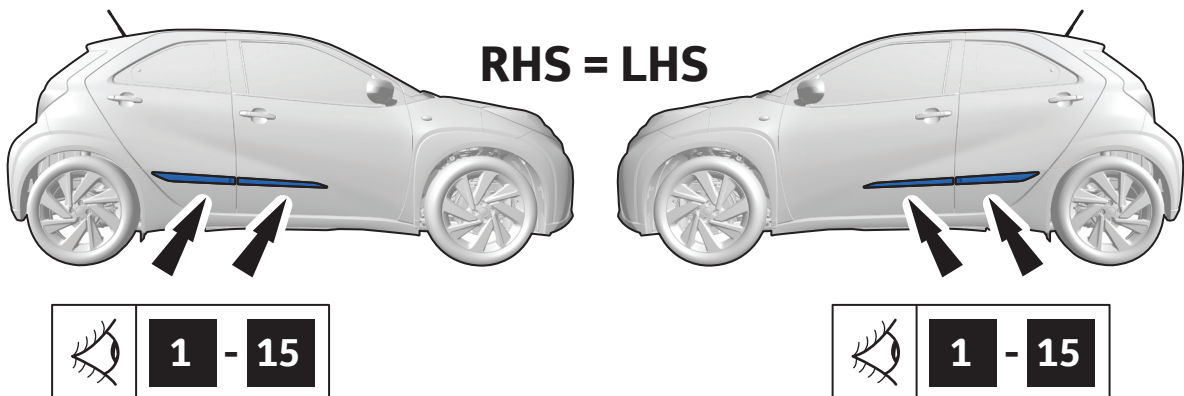

16

INFORMATION

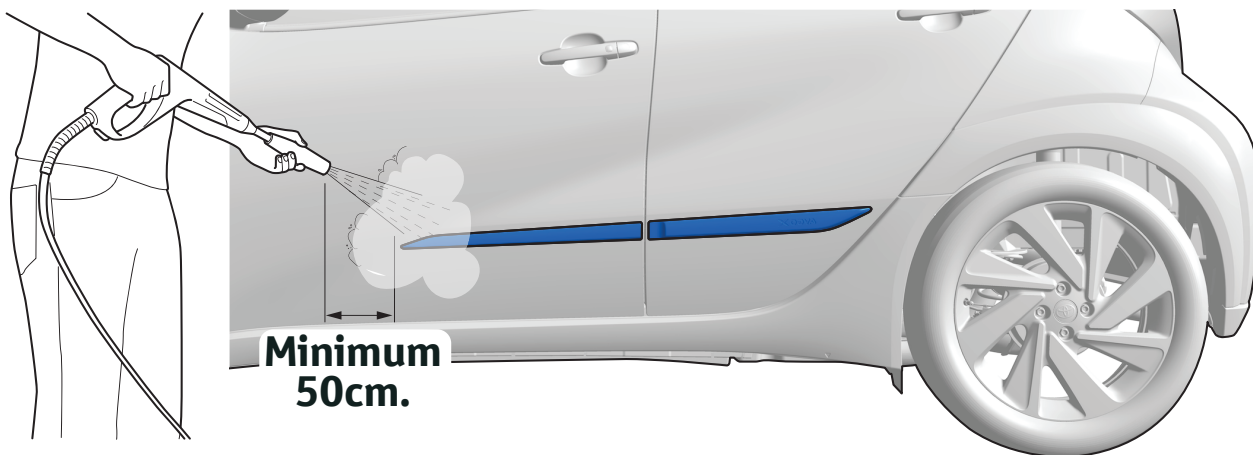
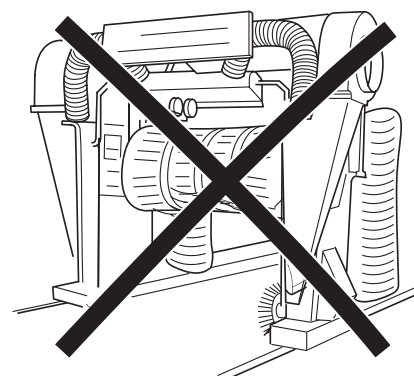

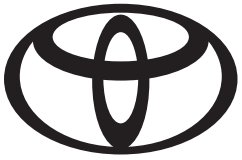

Model/Year **AYGO X**
As from 2022/03

Side Mouldings

VINn°

DURING INSTALLATION

1

P/N = OK

AFTER INSTALLATION

1

2 mm

A

A

181 mm

172 mm

540mm

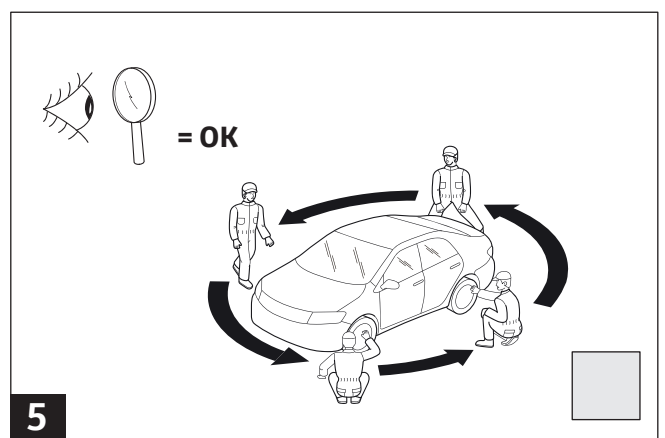
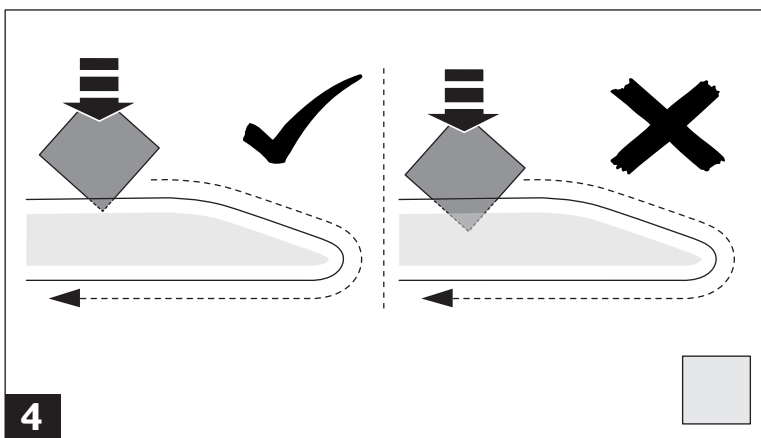
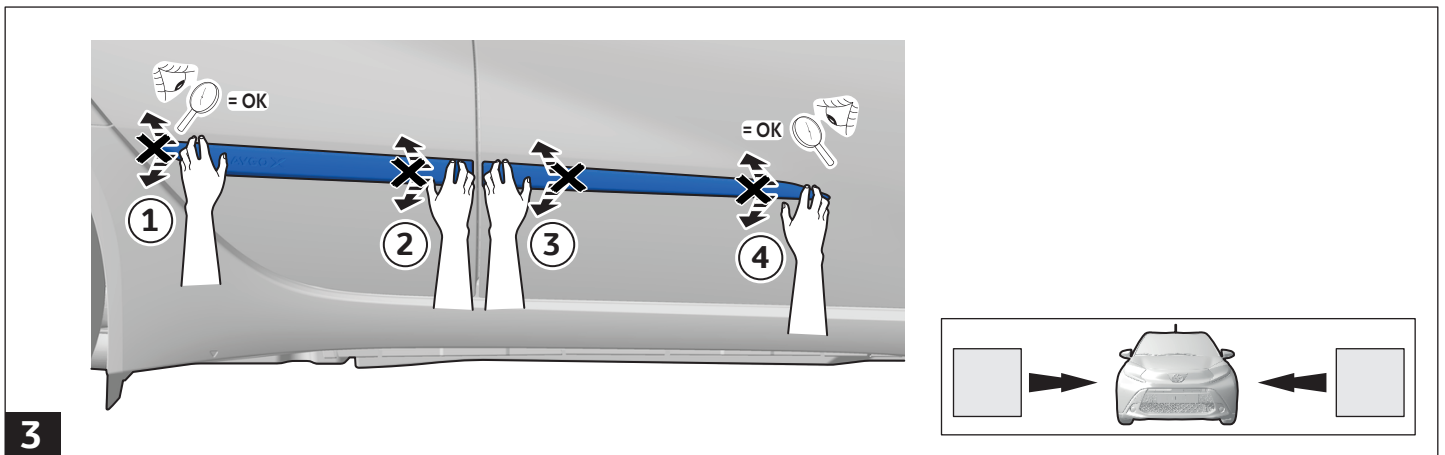
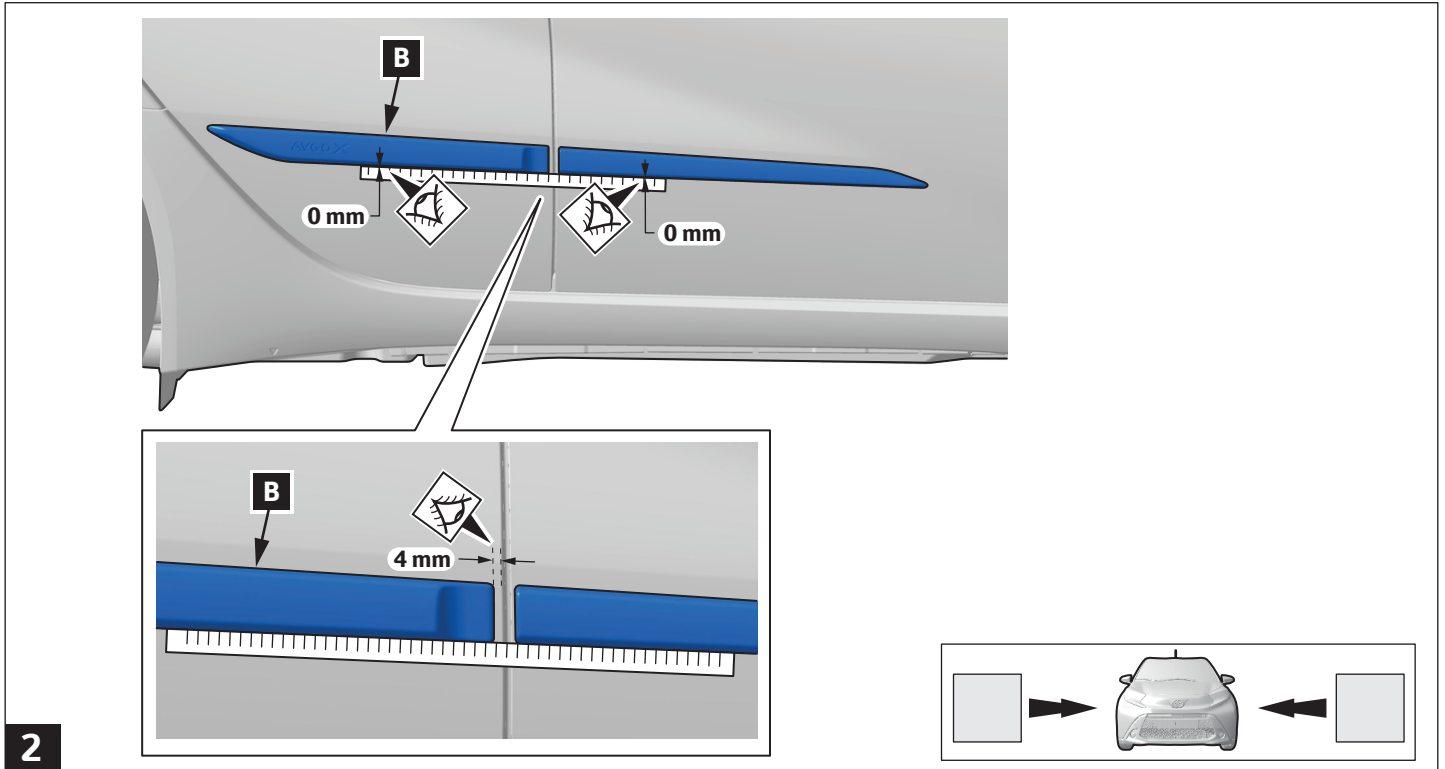

Installation Date:

. . / . . /

Technician Name & Signature:

Stamp: