



**TOYOTA**

ALWAYS A  
**BETTER WAY**

# TOYOTA C-HR

## Exterior sticker decoration

Installation Instructions





Model year: 2019/10  
Vehicle code: \*\*X\*\*\*-AH\*\*\*W  
Part number: PW18A-10101-\*\*

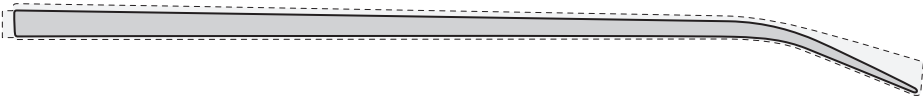

Manual reference number: AIM 004 555-1

# Revision record

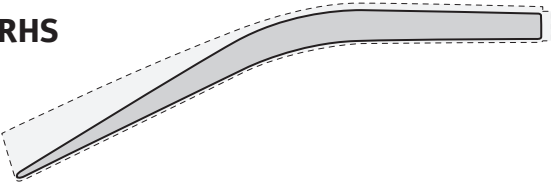
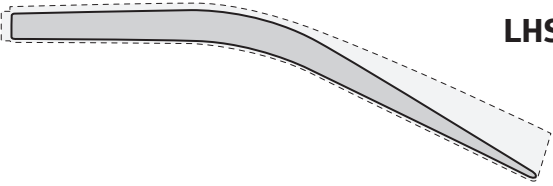
Rev. No.	Date	Page	Step	Remarks
△ <sub>1</sub>	22.03.2021	17-20	33-39	Procedure updated
△ <sub>1</sub>	22.03.2021			Temperature range updated

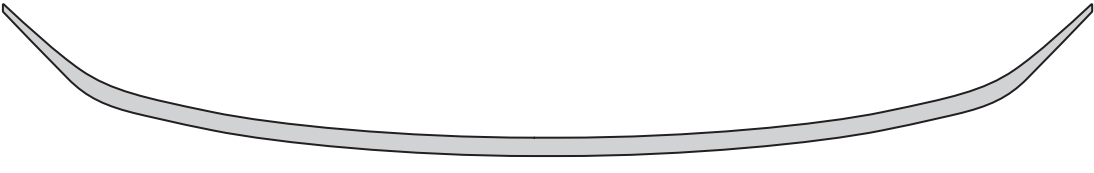
## PW18A-10101-\*\*

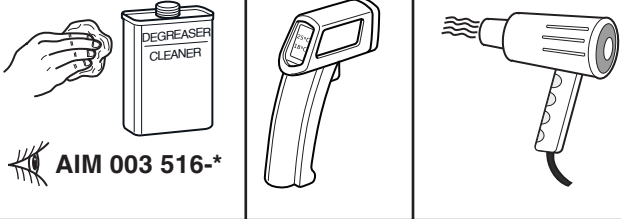
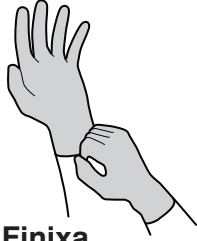
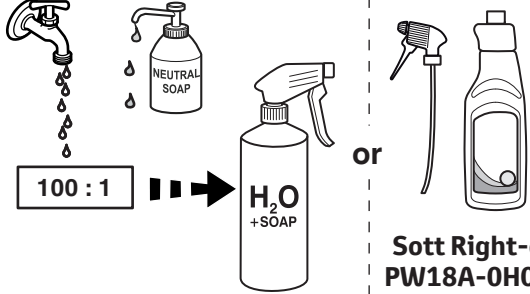
	RHS		
<b>A</b>	LHS		1x
<b>B</b>	RHS		LHS
			1x
<b>C</b>			1x
<b>D</b>			1x

		
	<b>PZ438-00030-90</b>  3M Gold Squeegee + Low Friction Sleeve <b>NOT INCLUDED</b>	<b>100 : 1</b> → <b>H<sub>2</sub>O + SOAP</b> or <b>Sott Right-on PW18A-0H000</b>

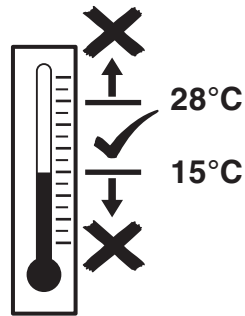
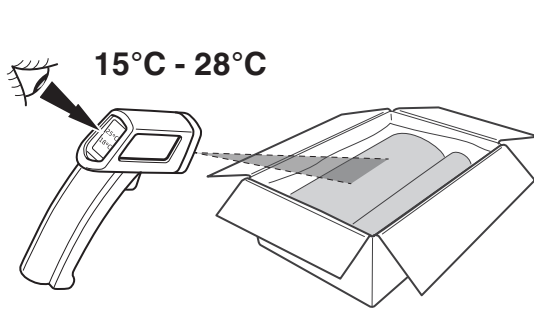
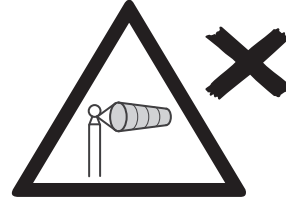
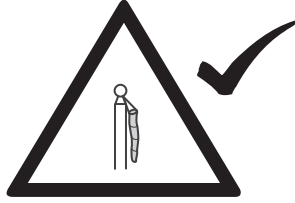
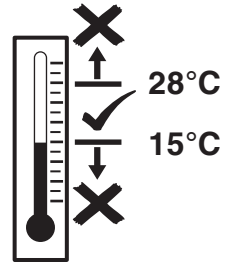
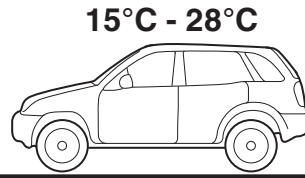
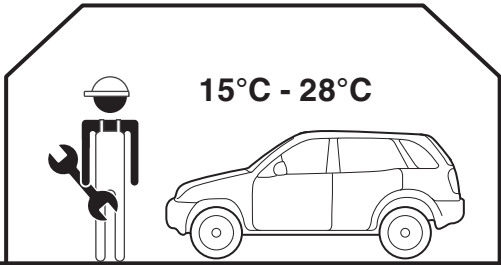

**Material Safety Data Sheet**



**Technical Data Sheet**

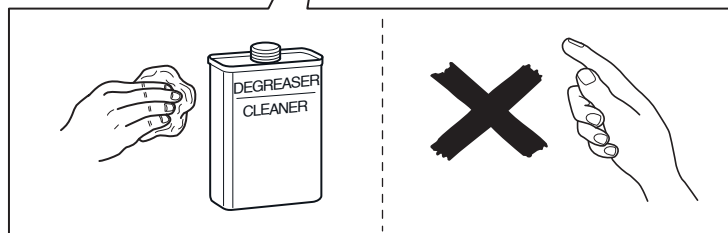
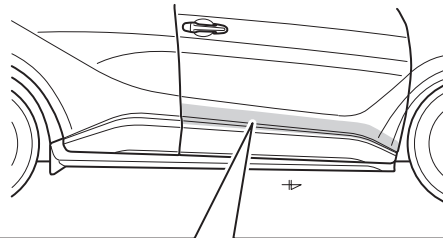
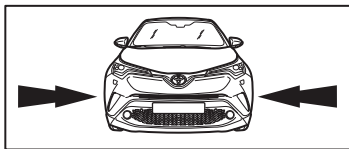

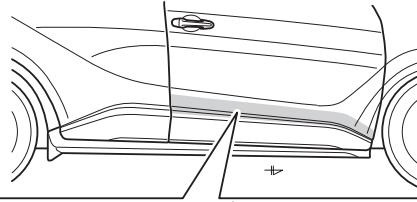
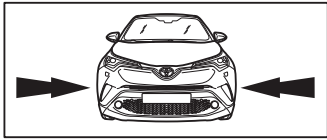

<p>1</p>	<p>&lt; 15°C → 2</p> <p>15°C - 28°C → 3</p>	<p>2</p>
<p>3</p>	<p>15°C - 28°C → 3</p>	<p><b>INFO</b></p> <p>2 → 7</p>

2

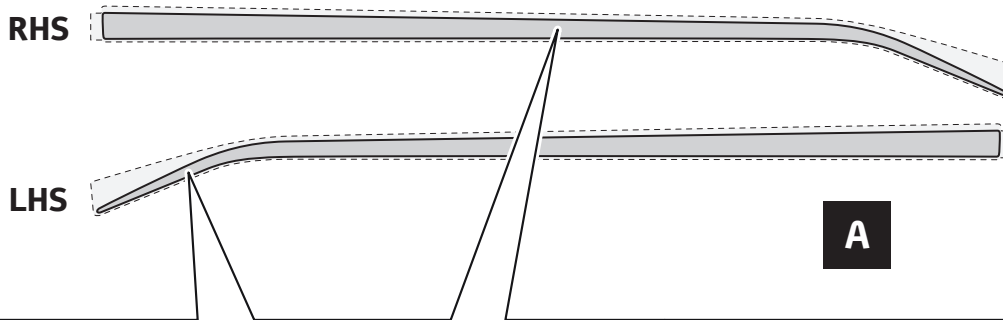

<p>1</p>	<p>&lt; 15°C → 2</p> <p>15°C - 28°C → 4</p>	<p>2</p>
<p>3</p>	<p>15°C - 28°C → 4</p>	<p><b>INFO</b></p> <p>3 → 7</p>

3

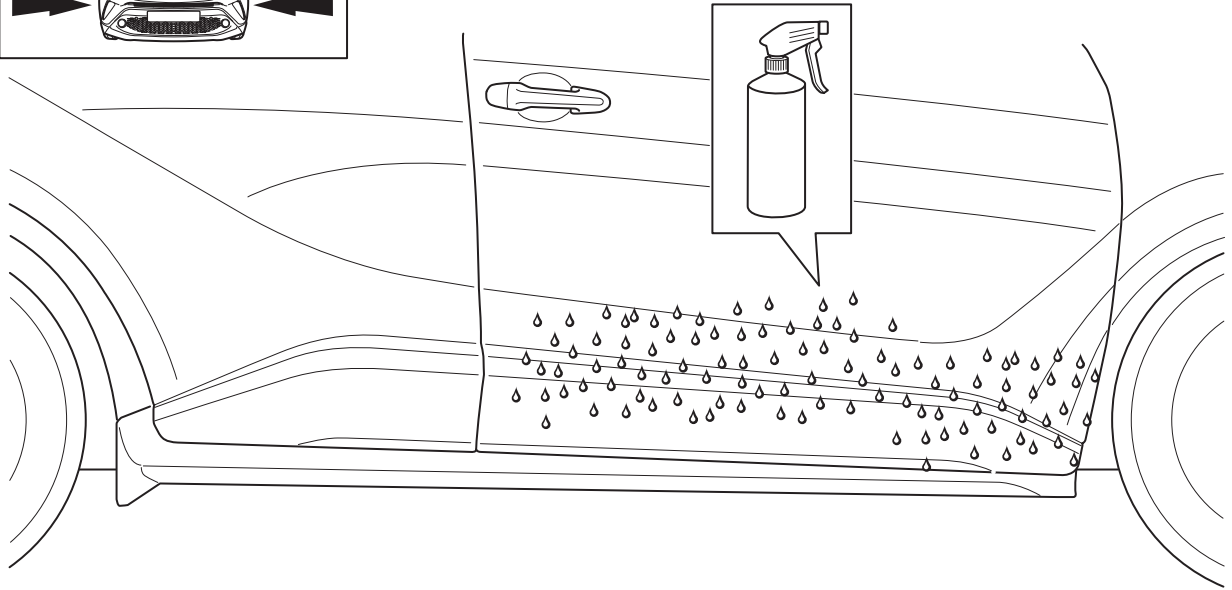
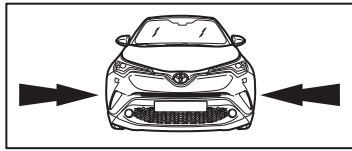

4

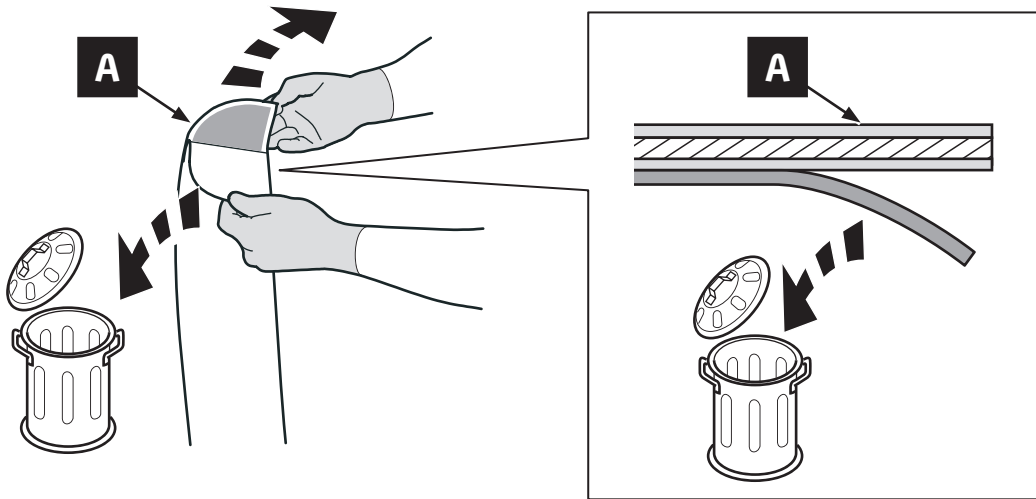

5

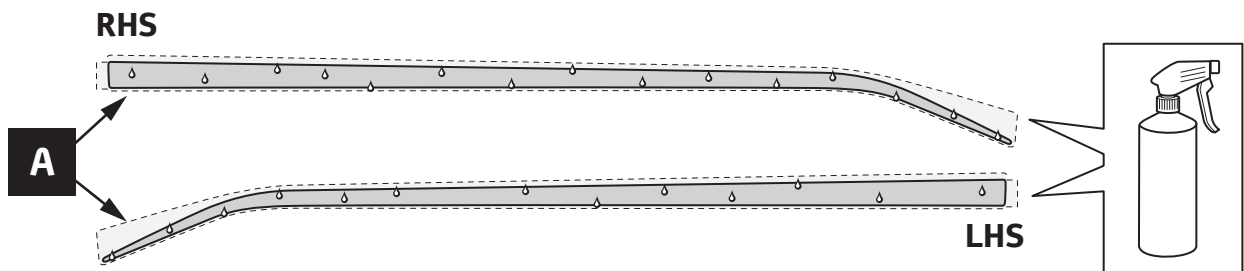

6

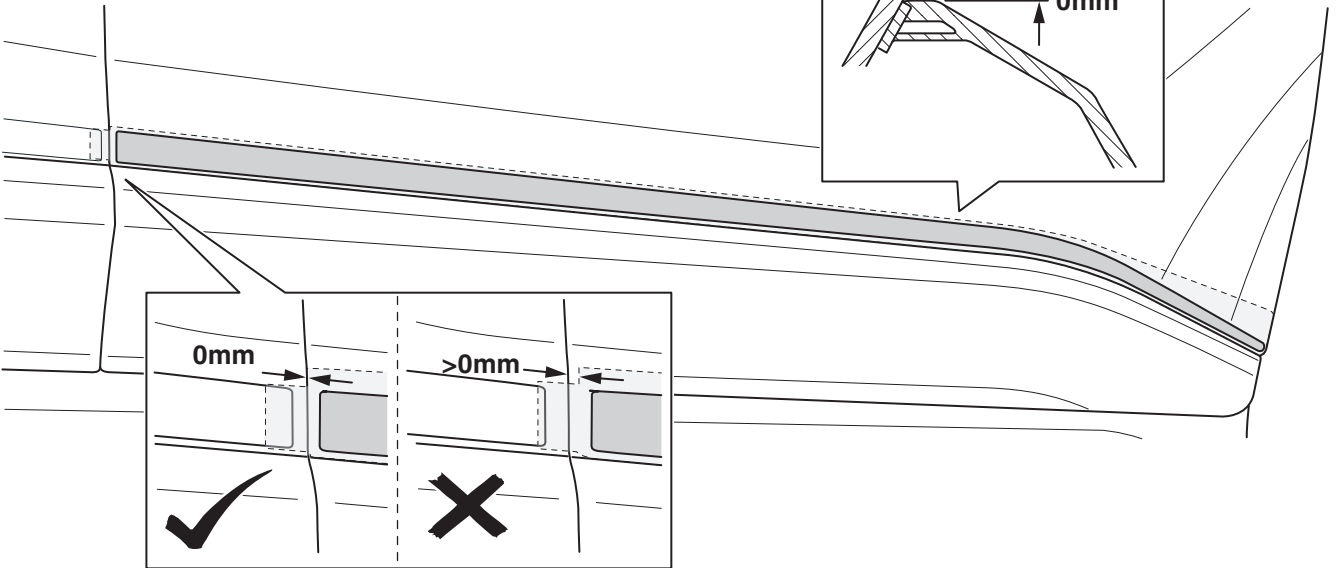
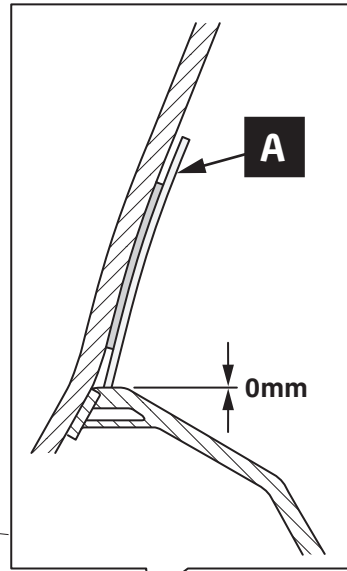
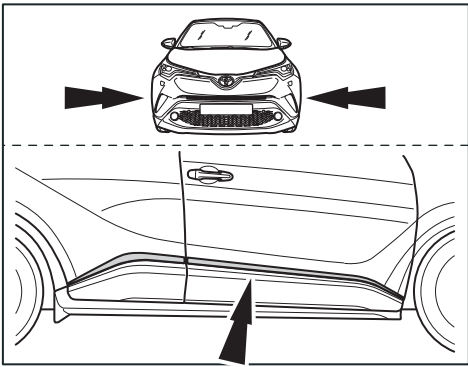

7

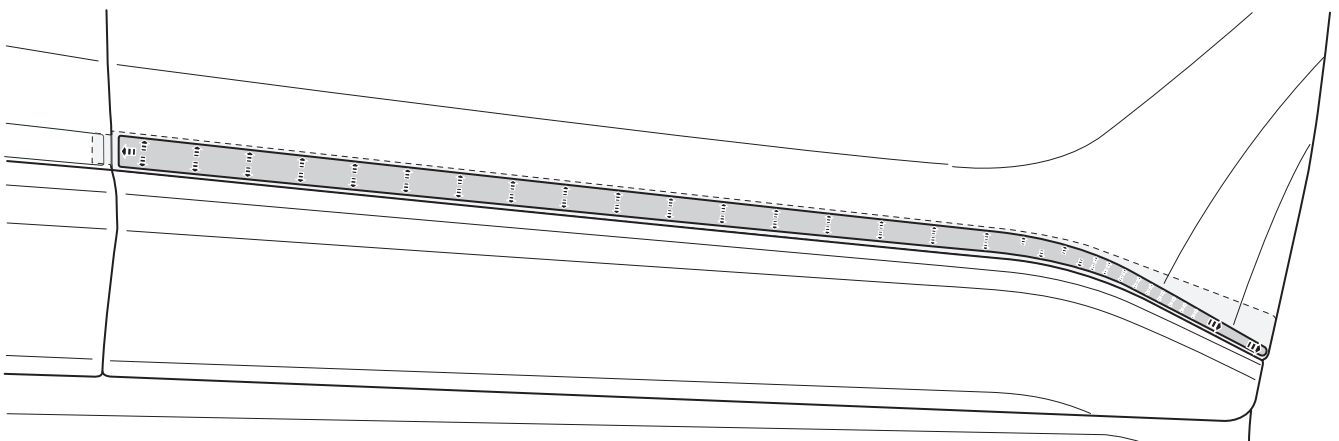
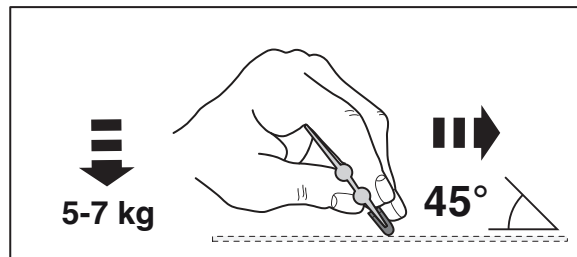
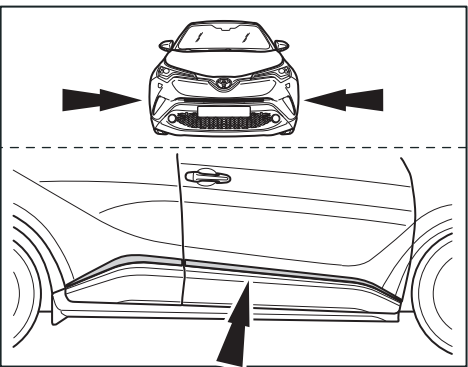

8

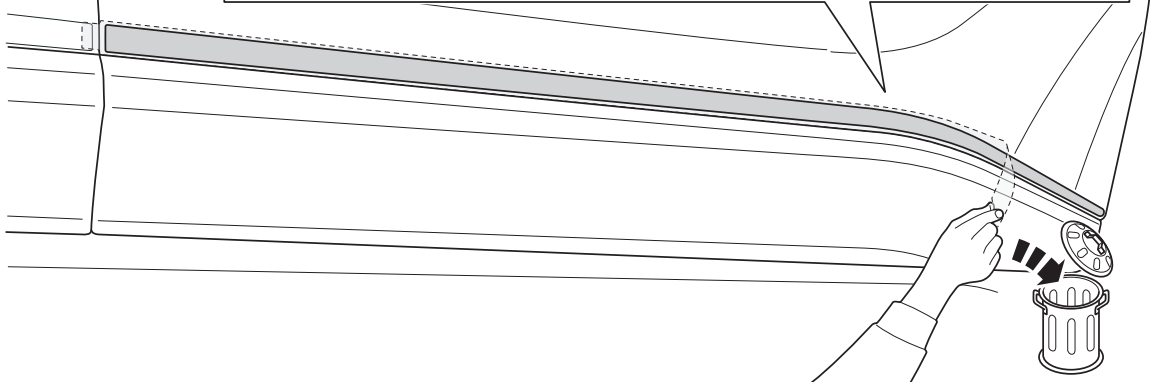
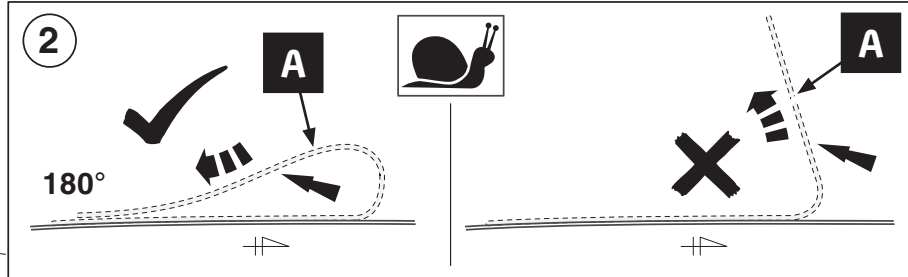
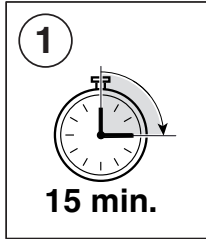
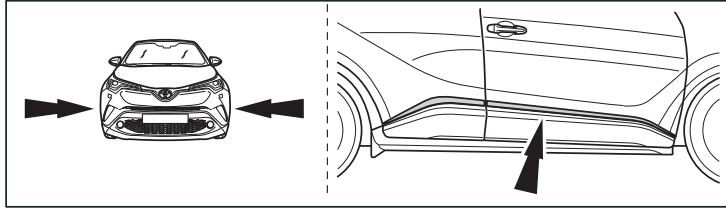

9

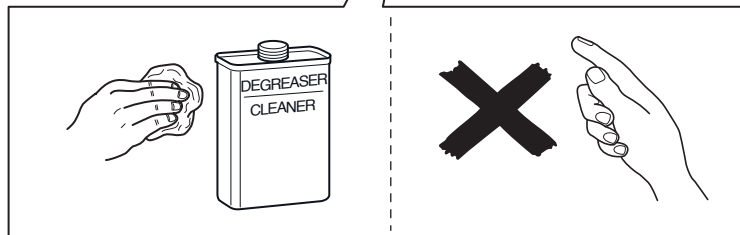
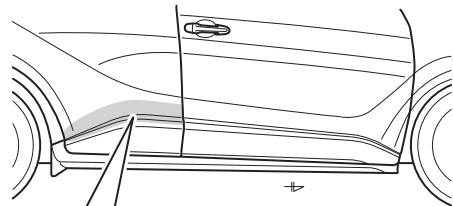
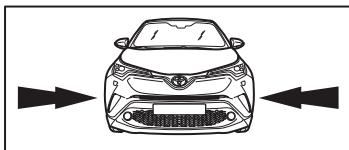

10

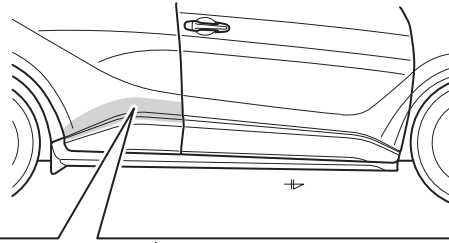
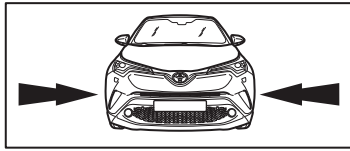

<p>1</p>	<p>&lt; 15°C → 2</p> <p>15°C - 28°C → 12</p>	<p>2</p>
<p>3</p>	<p>15°C - 28°C → 12</p>	<p><b>INFO</b></p>

11

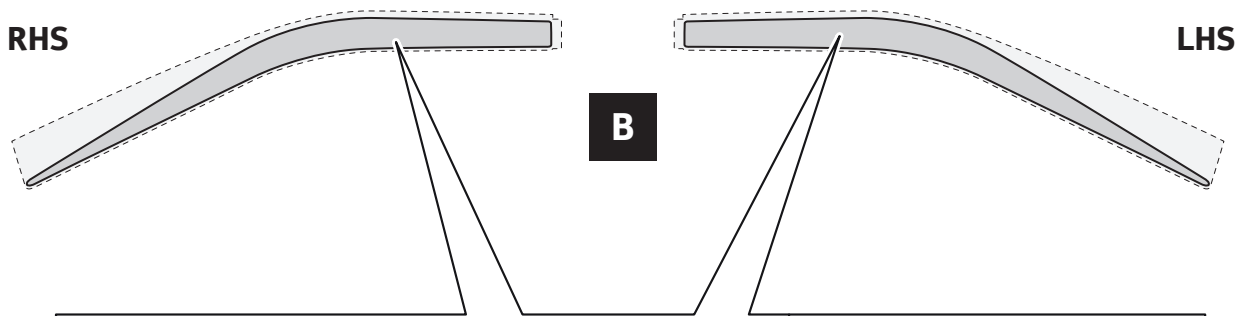

<p>1</p>	<p>&lt; 15°C → 2</p> <p>15°C - 28°C → 13</p>	<p>2</p>
<p>3</p>	<p>15°C - 28°C → 13</p>	<p><b>INFO</b></p>

12



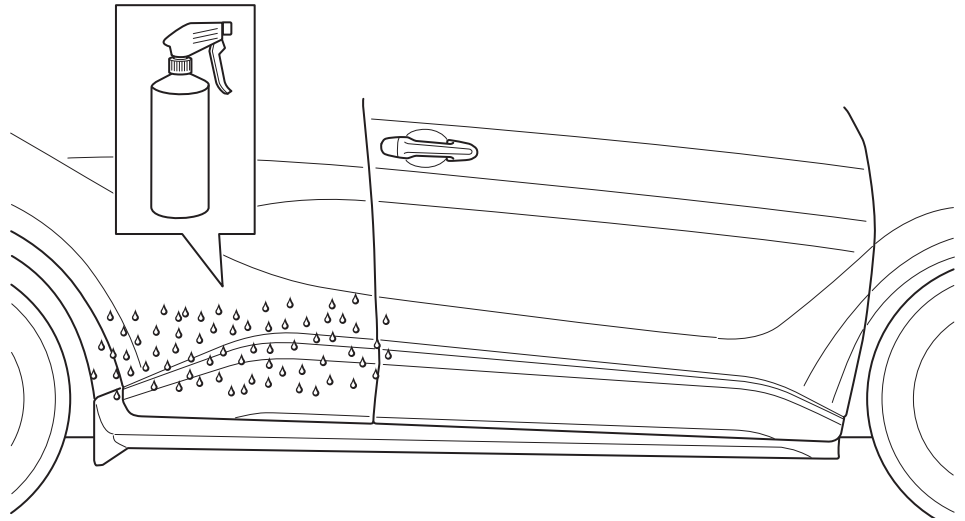
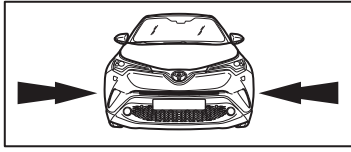

13

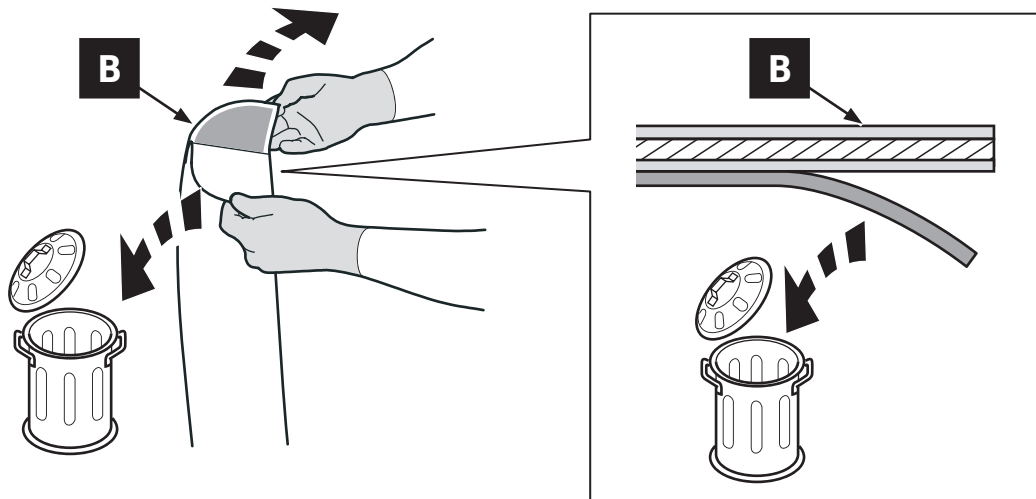

14

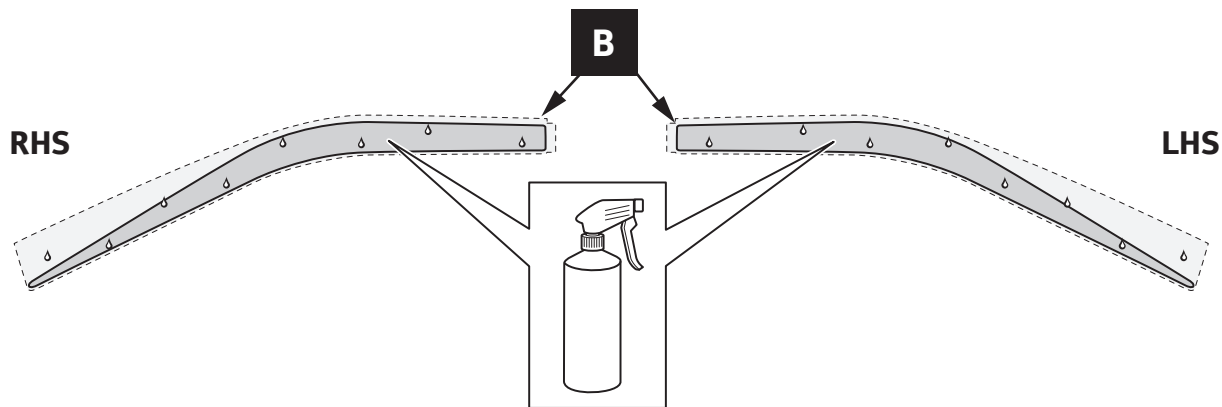

15

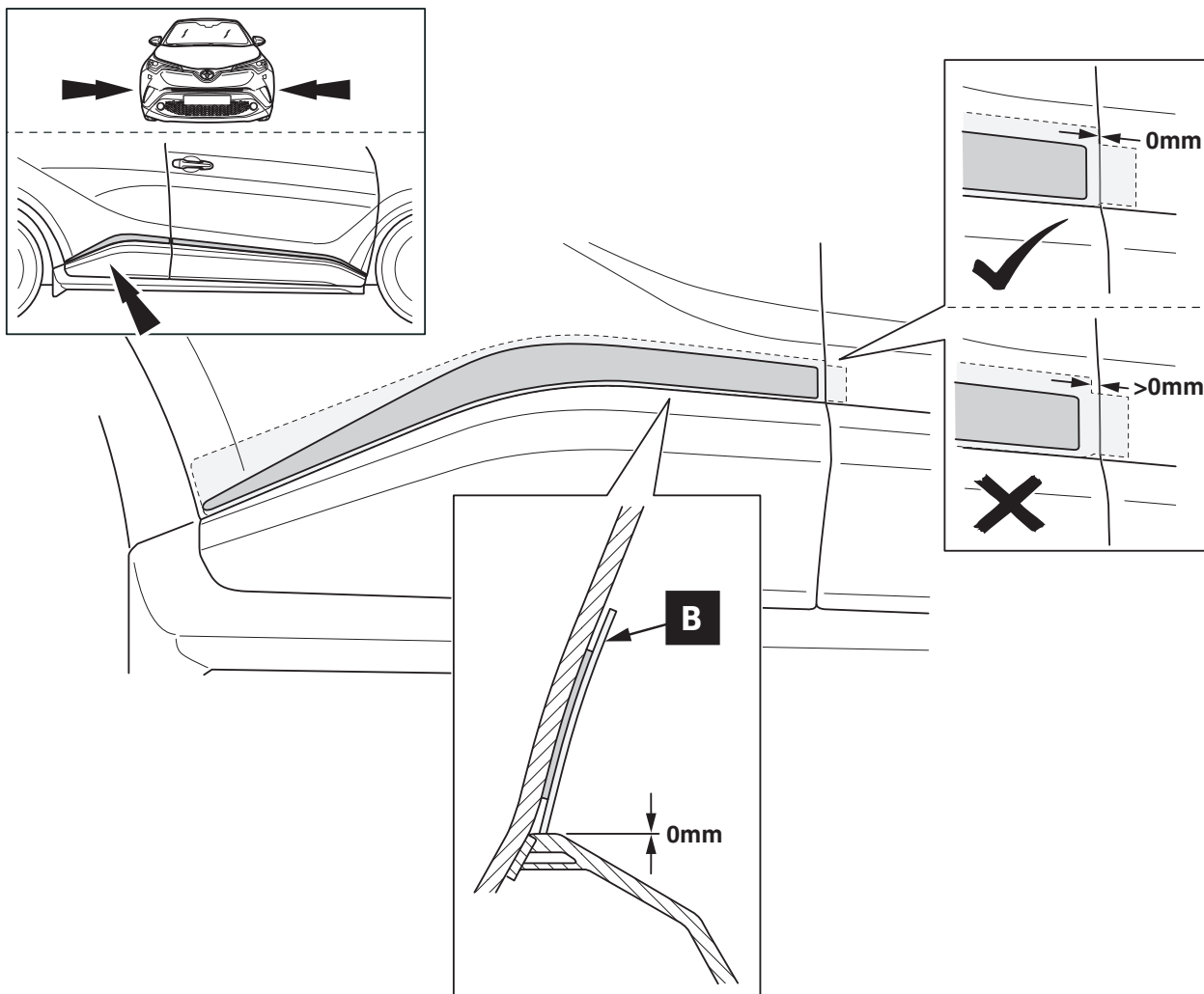

16

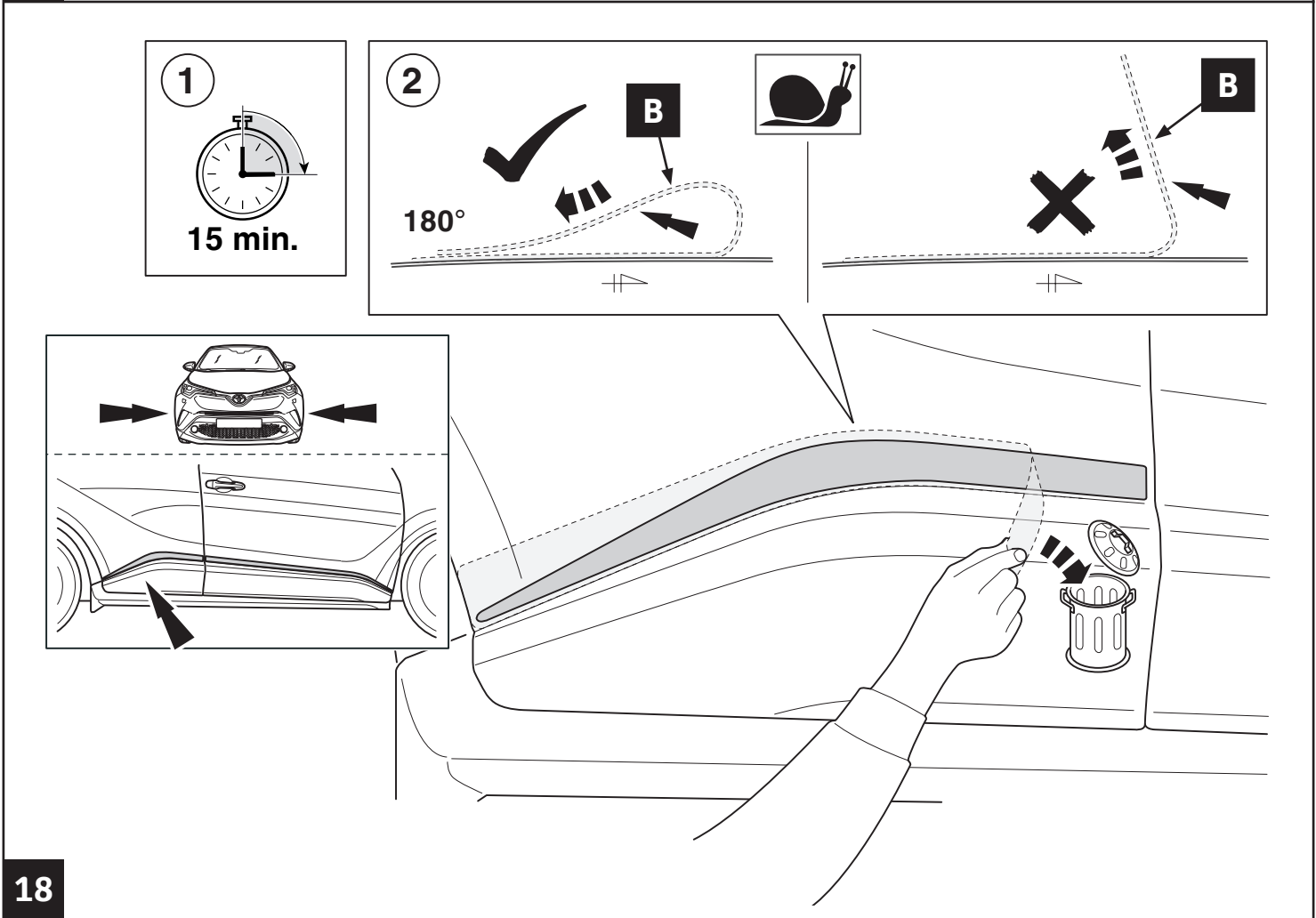
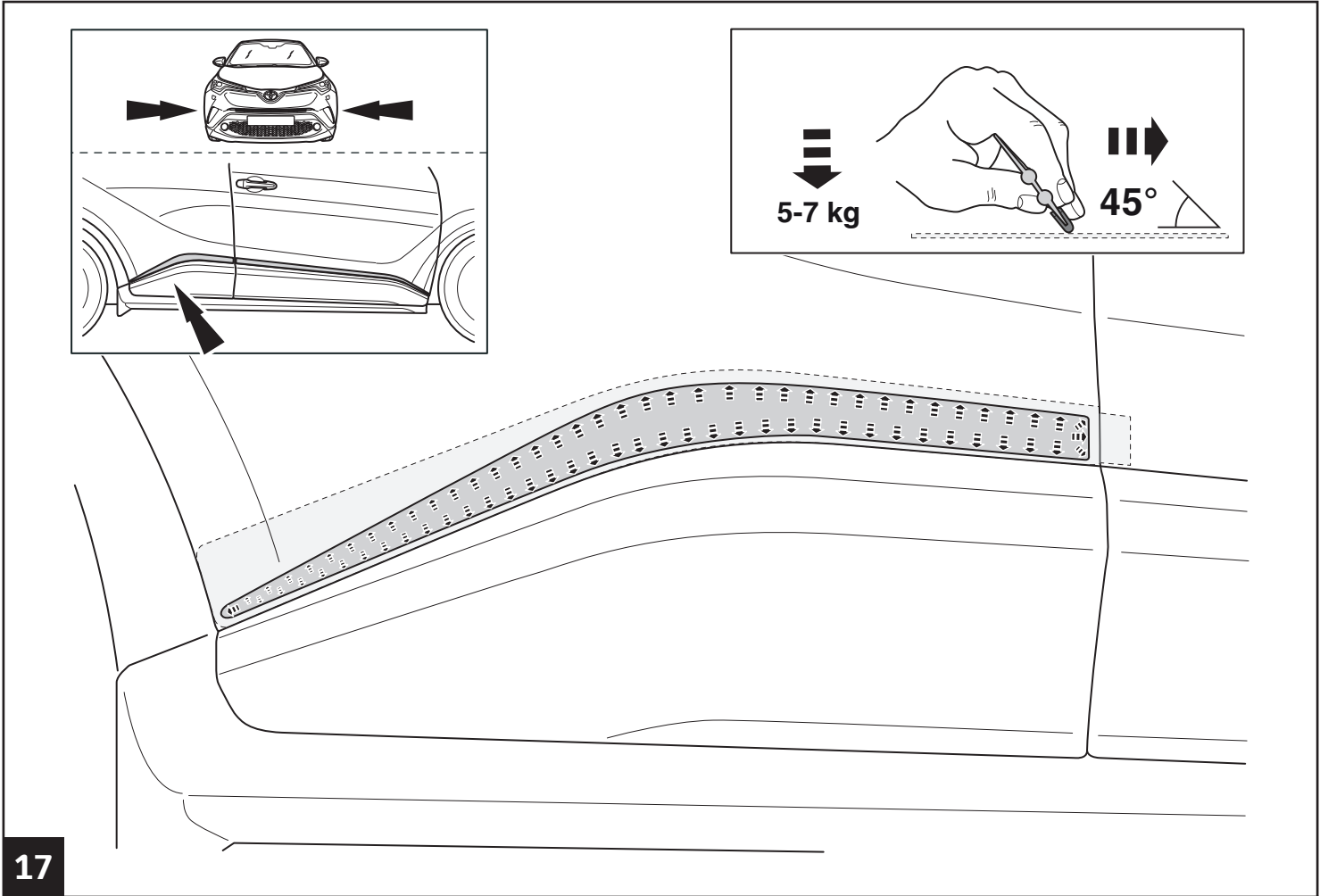

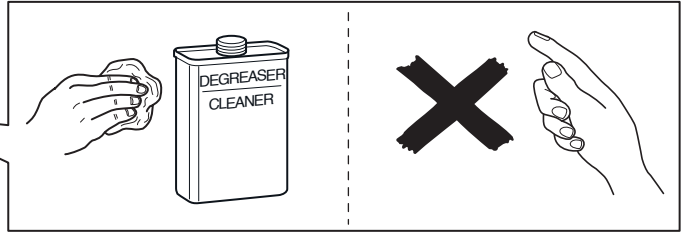
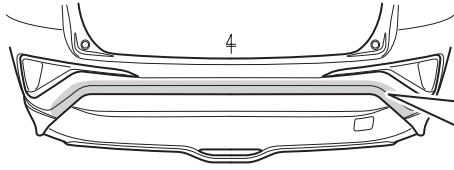

19

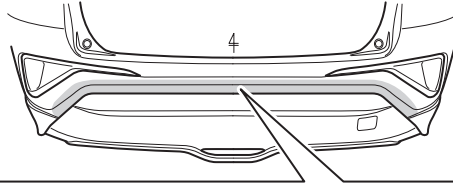

<p>1</p>	<p>&lt; 15°C → 2</p> <p>15°C - 28°C → 21</p>	<p>2</p>
<p>3</p>	<p>15°C - 28°C → 21</p>	<p><b>INFO</b></p>

20

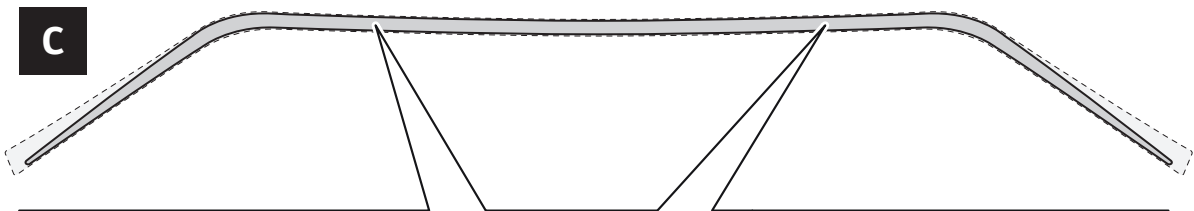

<p>1</p>	<p>&lt; 15°C → 2</p> <p>15°C - 28°C → 22</p>	<p>2</p>
<p>3</p>	<p>15°C - 28°C → 22</p>	<p><b>INFO</b></p>

21

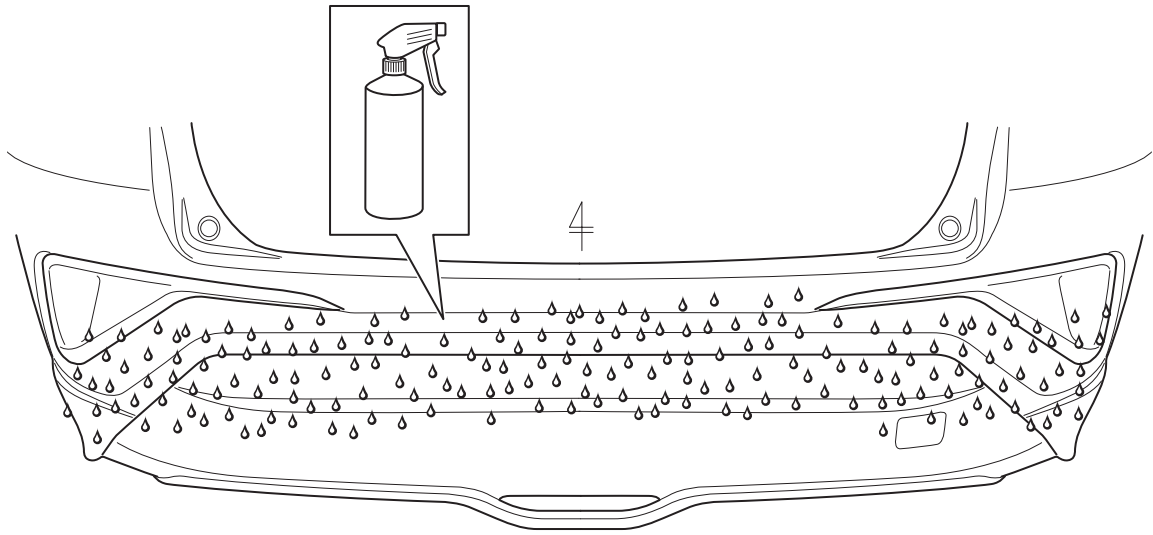

22

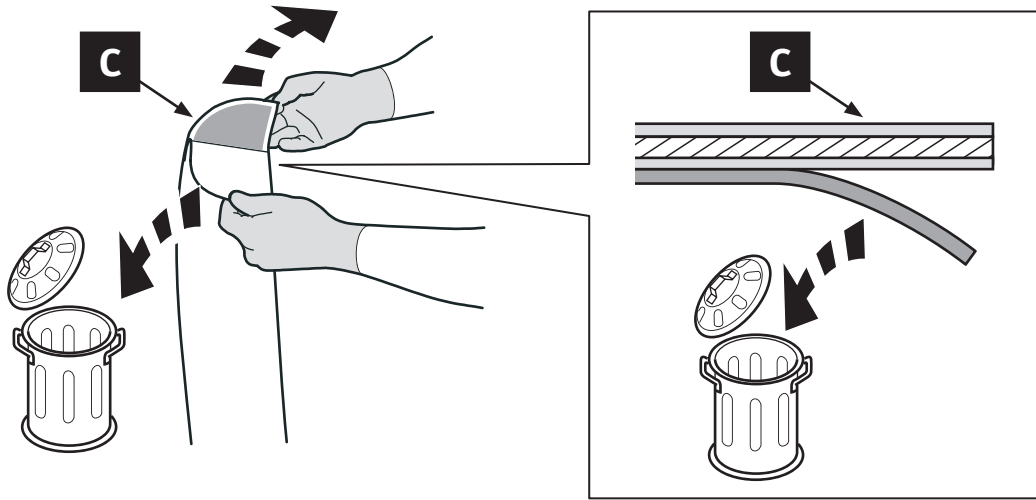

23

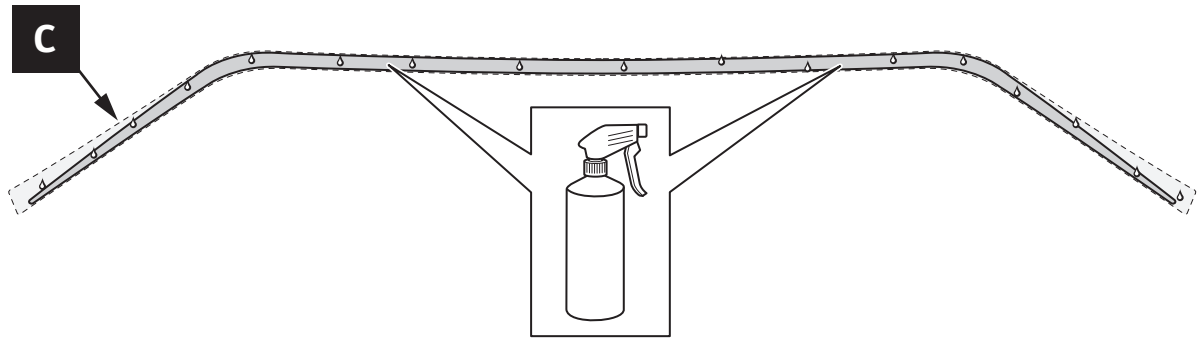

24

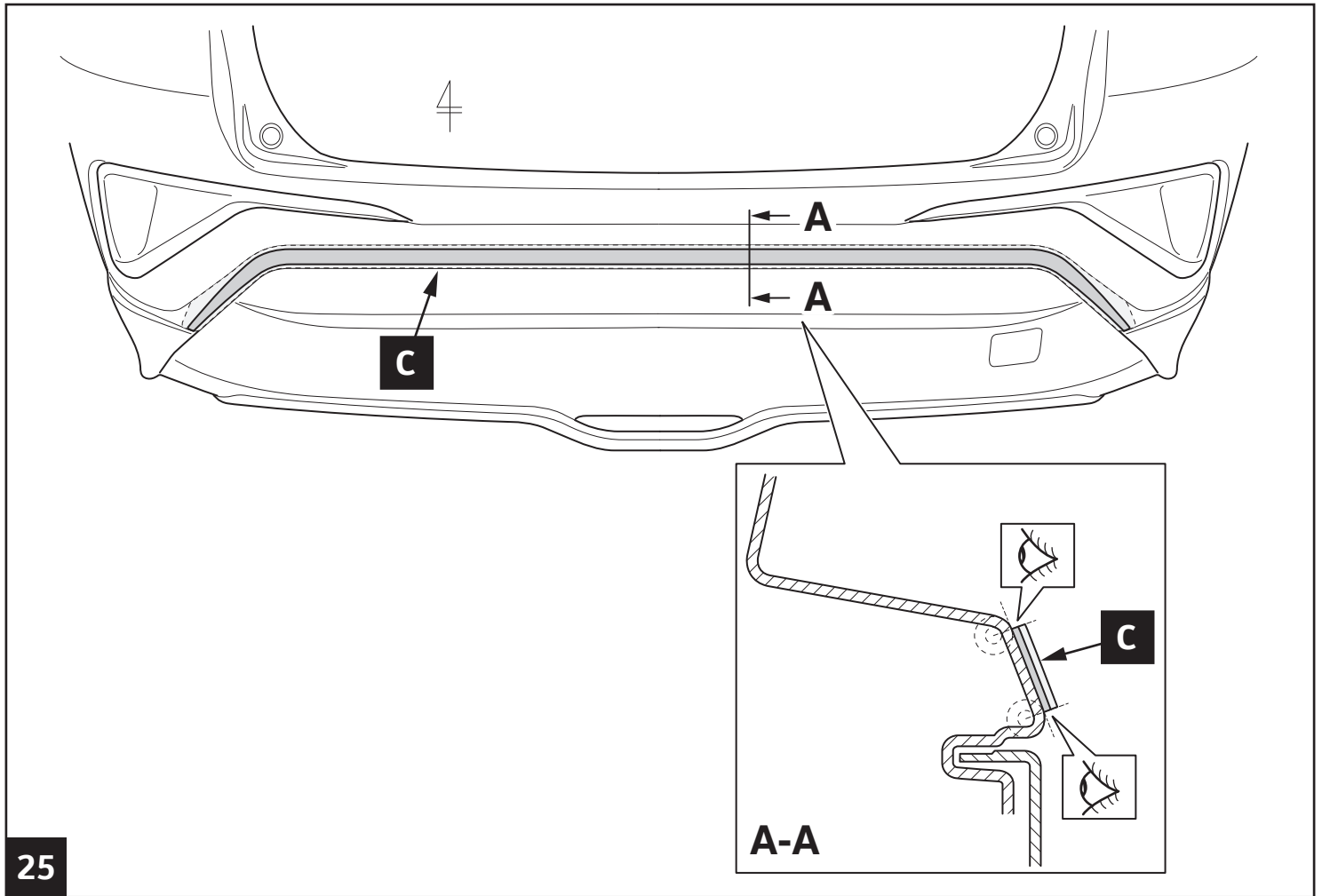

25

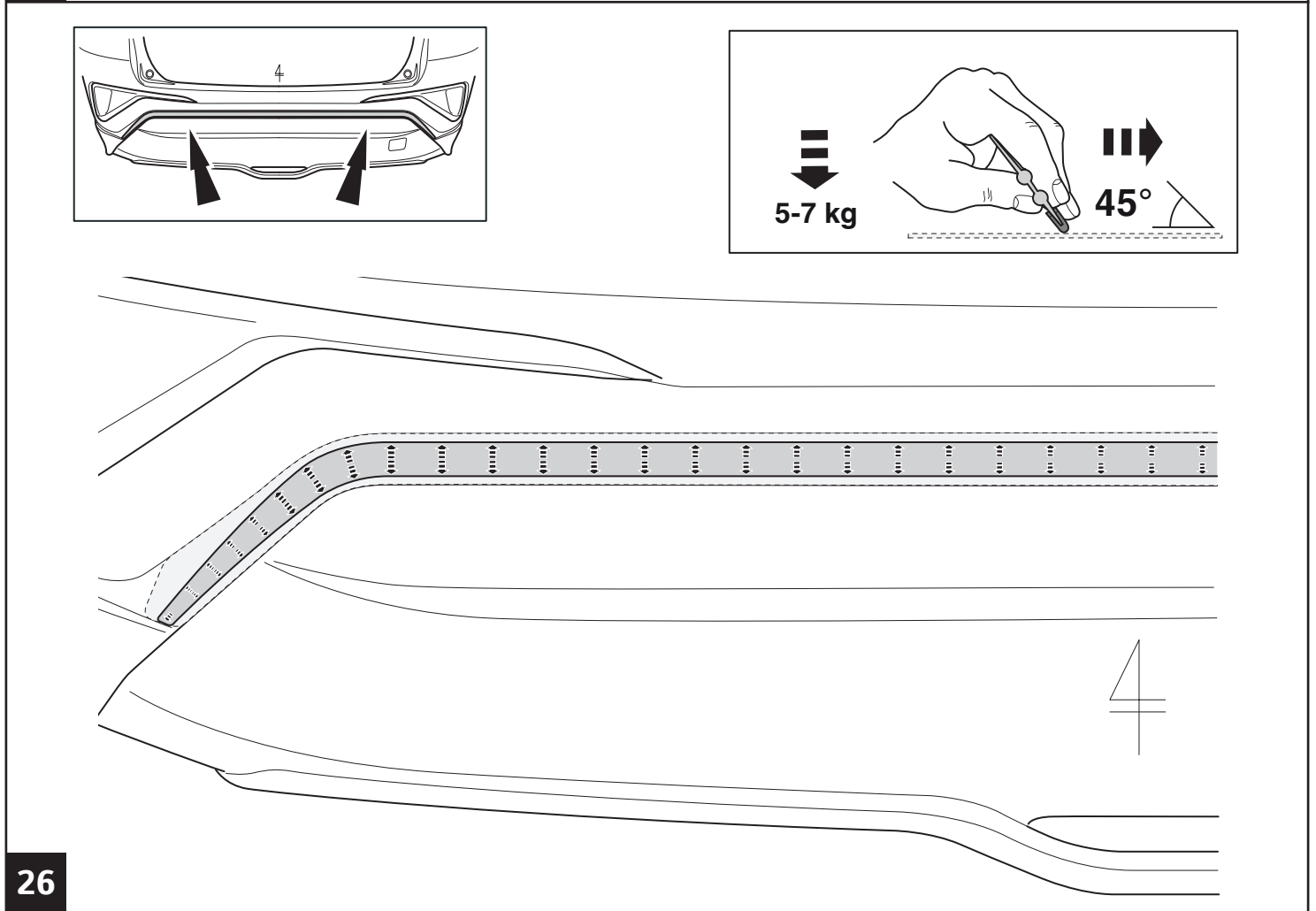

26

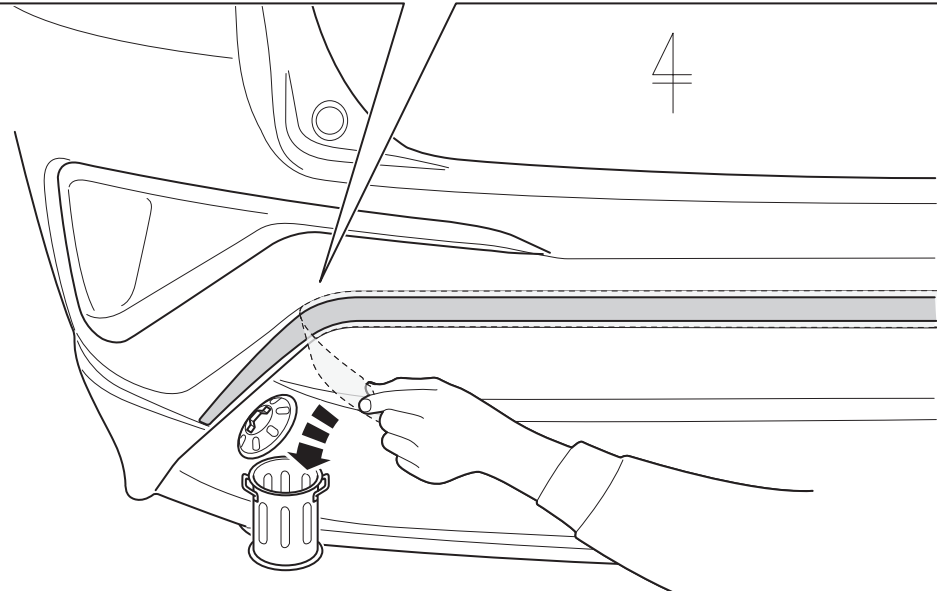
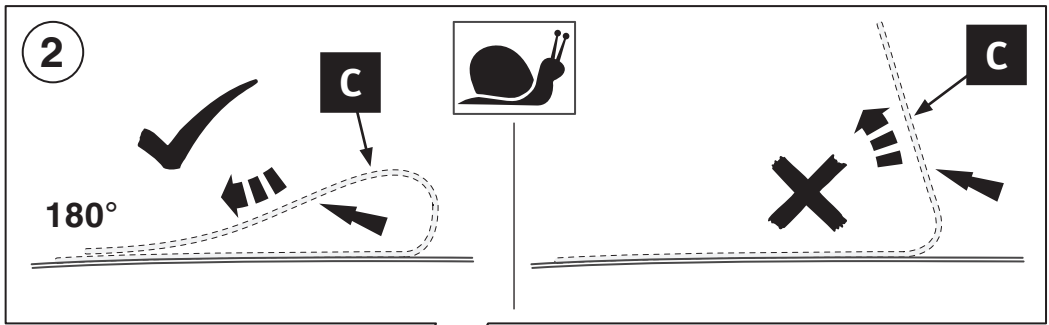
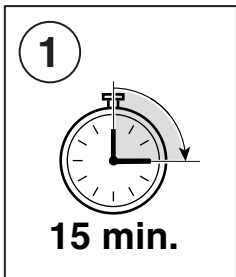

27

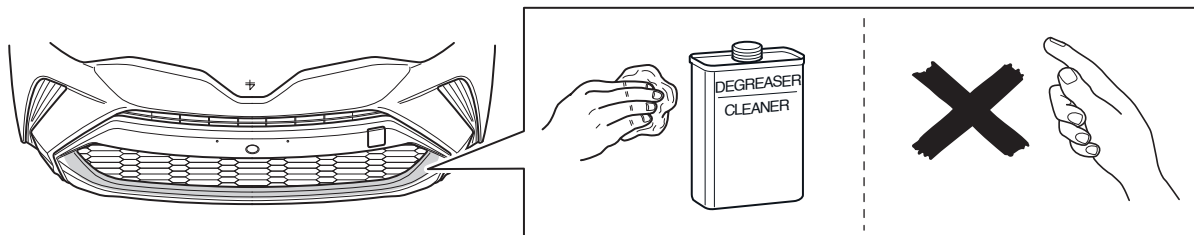

28

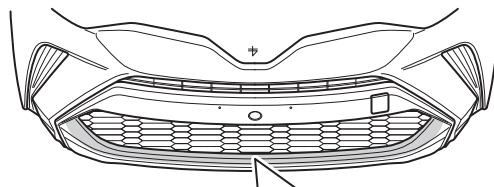

<p><b>1</b></p> <p>? °C</p>	<p>&lt; 15°C → <b>2</b></p> <p>15°C - 28°C → <b>30</b></p>	<p><b>2</b></p> <p>+ °C</p>
<p><b>3</b></p> <p>? °C</p>	<p>15°C - 28°C → <b>30</b></p>	<p><b>INFO</b></p> <p>29 → 34</p>

29

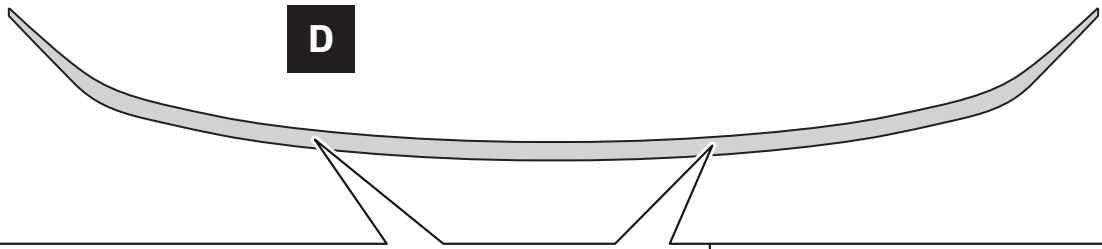

<p><b>1</b></p> <p>? °C</p>	<p>&lt; 15°C → <b>2</b></p> <p>15°C - 28°C → <b>31</b></p>	<p><b>2</b></p> <p>+ °C</p>
<p><b>3</b></p> <p>? °C</p>	<p>15°C - 28°C → <b>31</b></p>	<p><b>INFO</b></p> <p><b>30</b> → <b>34</b></p> <p>✓</p> <p>✗</p>

**30**

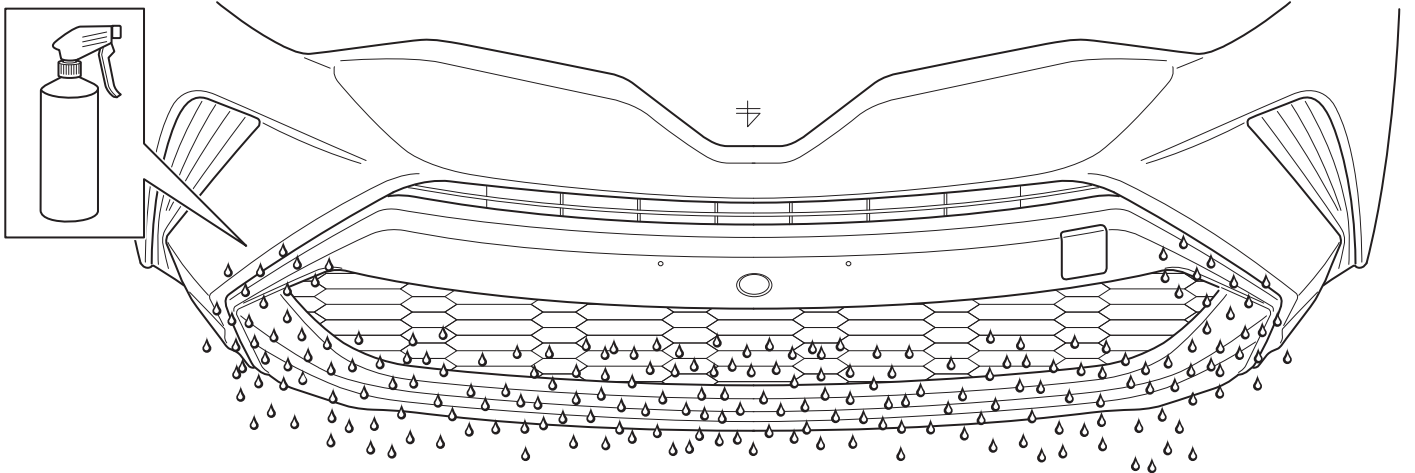

**31**



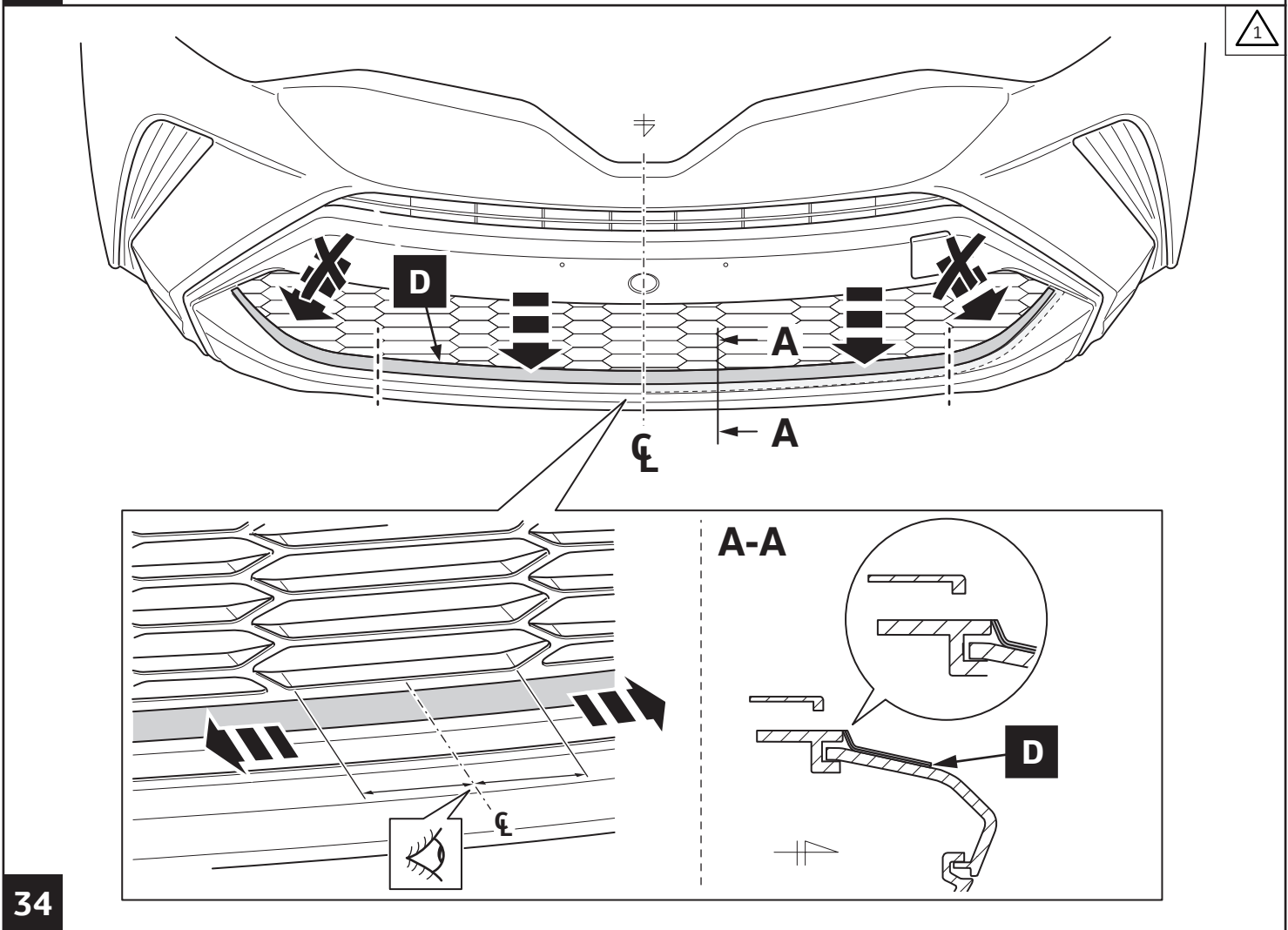
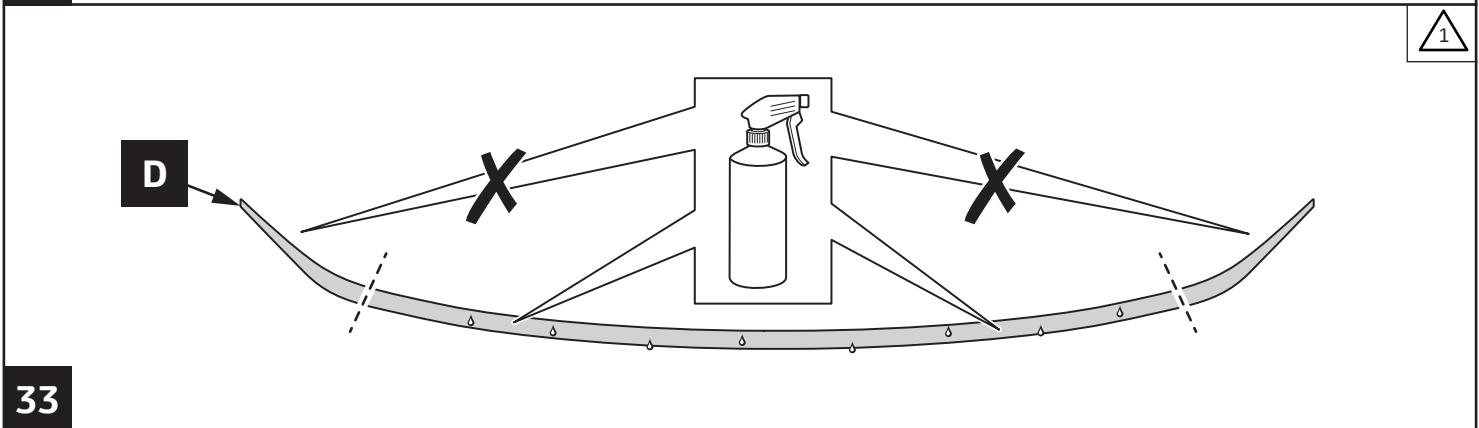
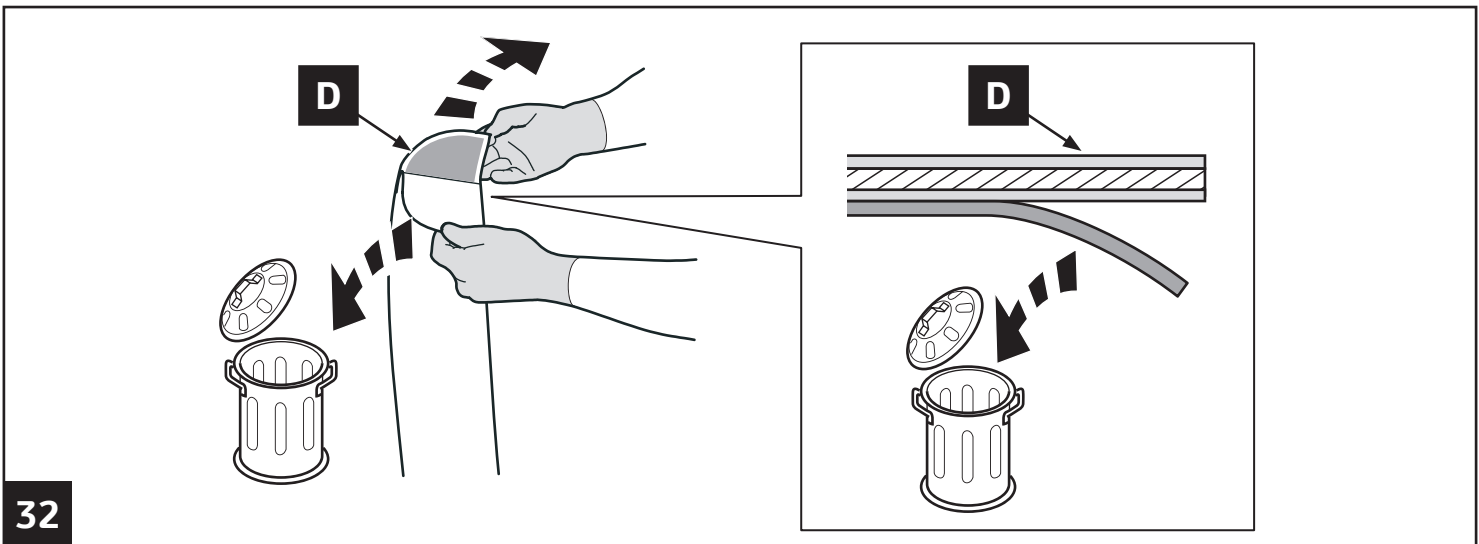

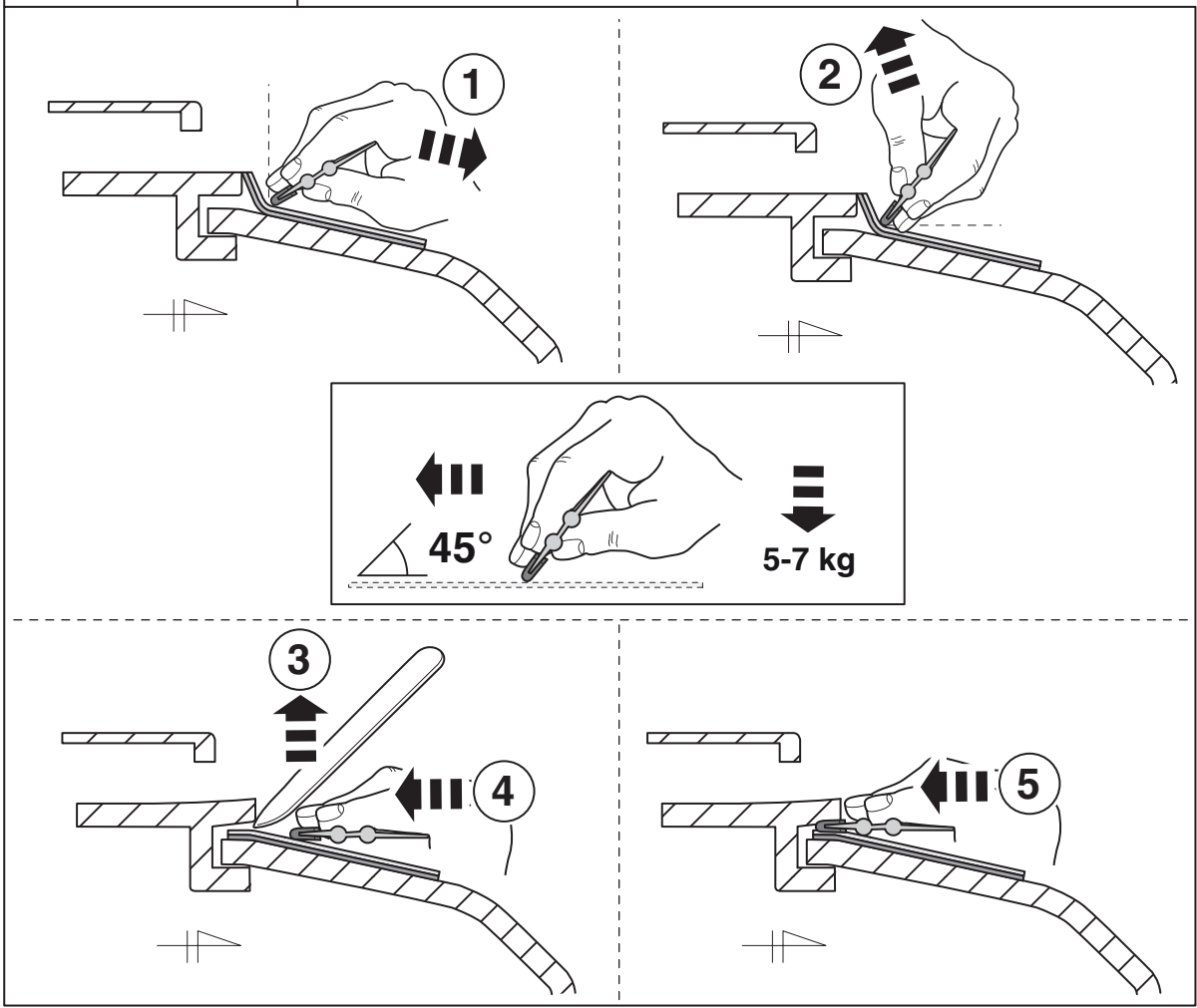
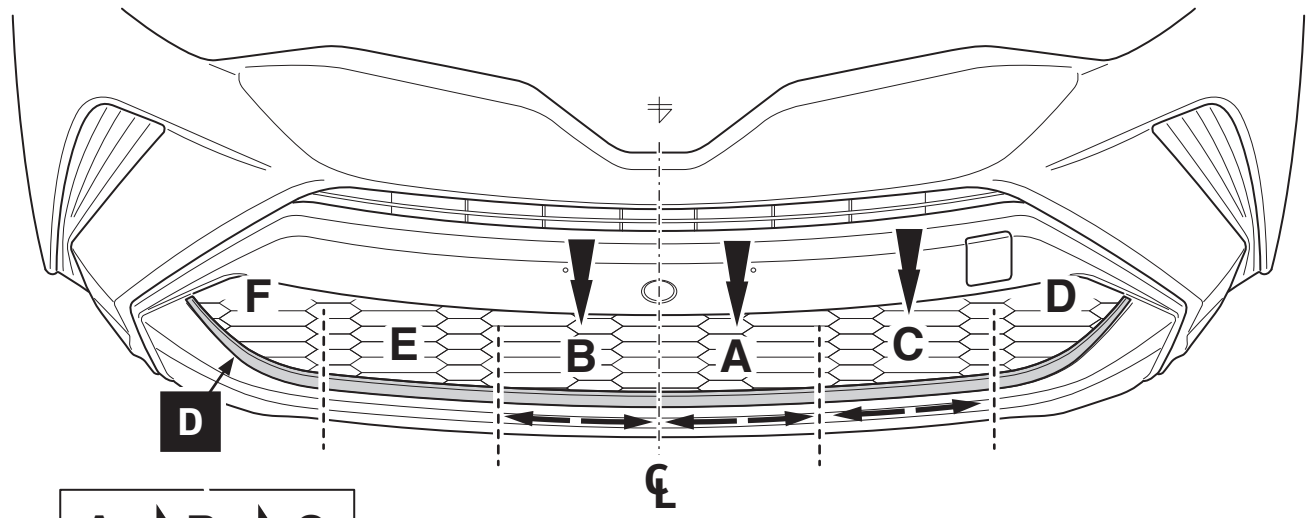

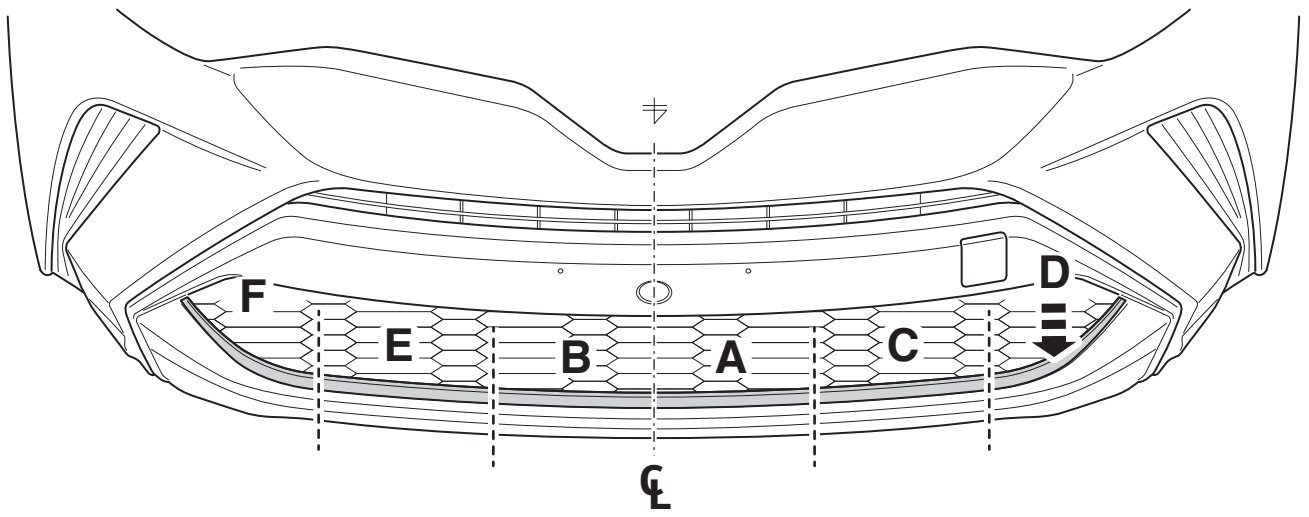

36

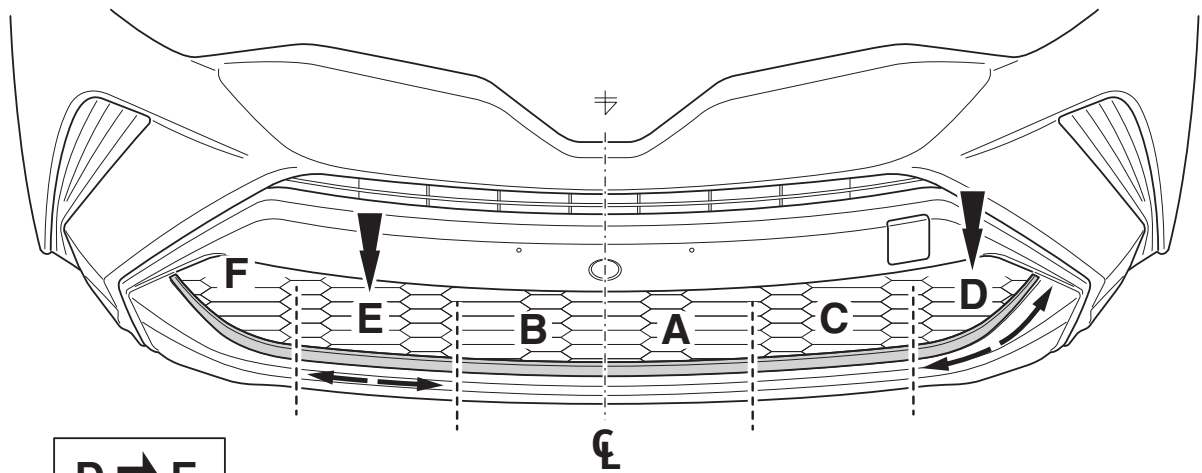

D → E

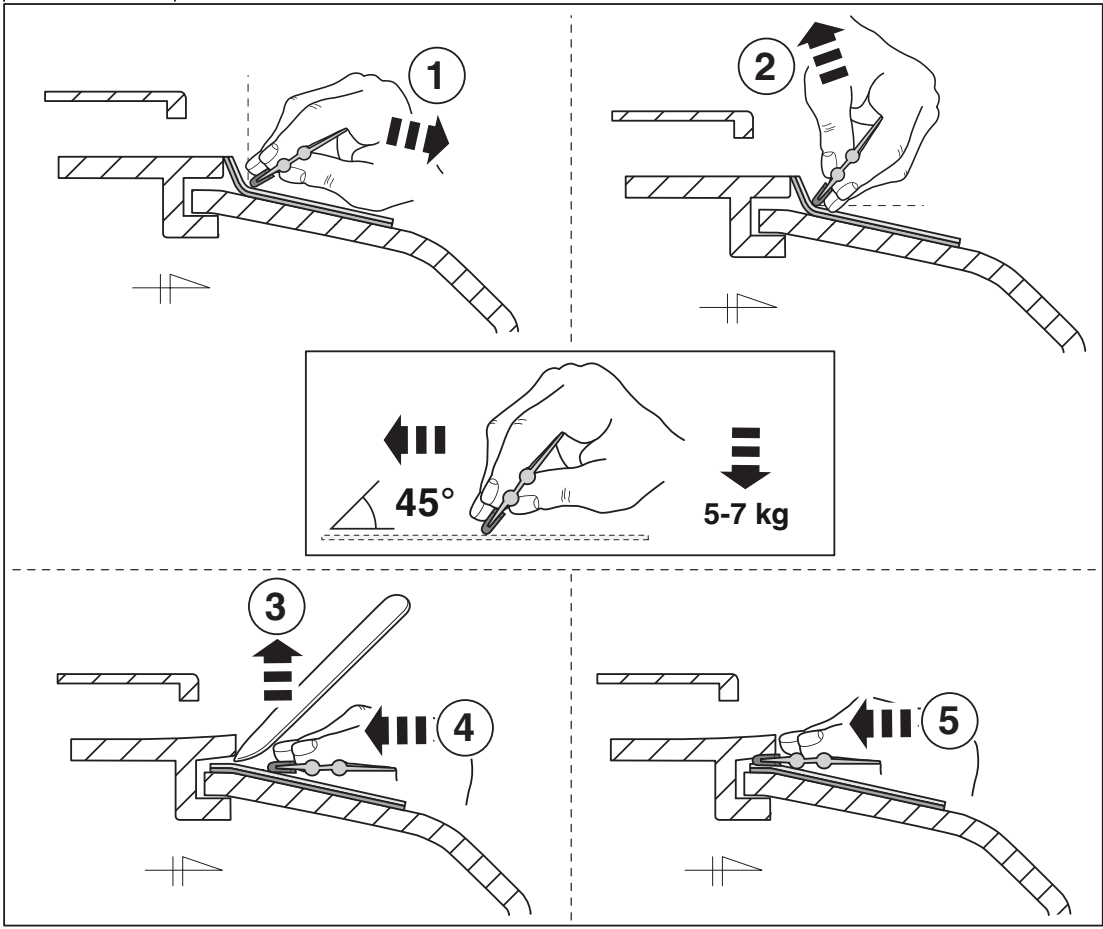

37

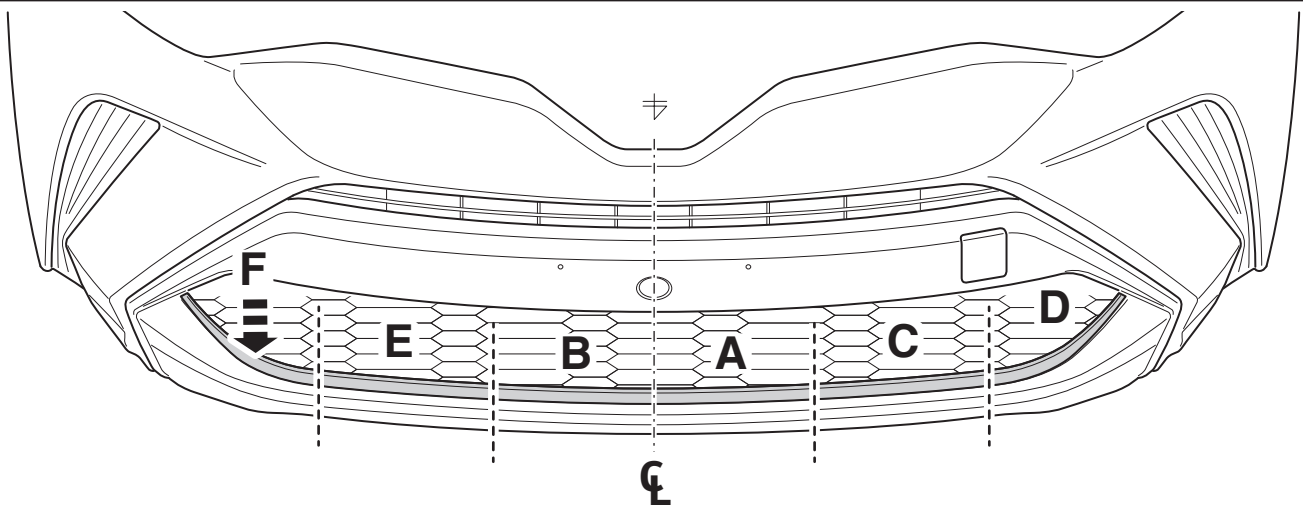

38

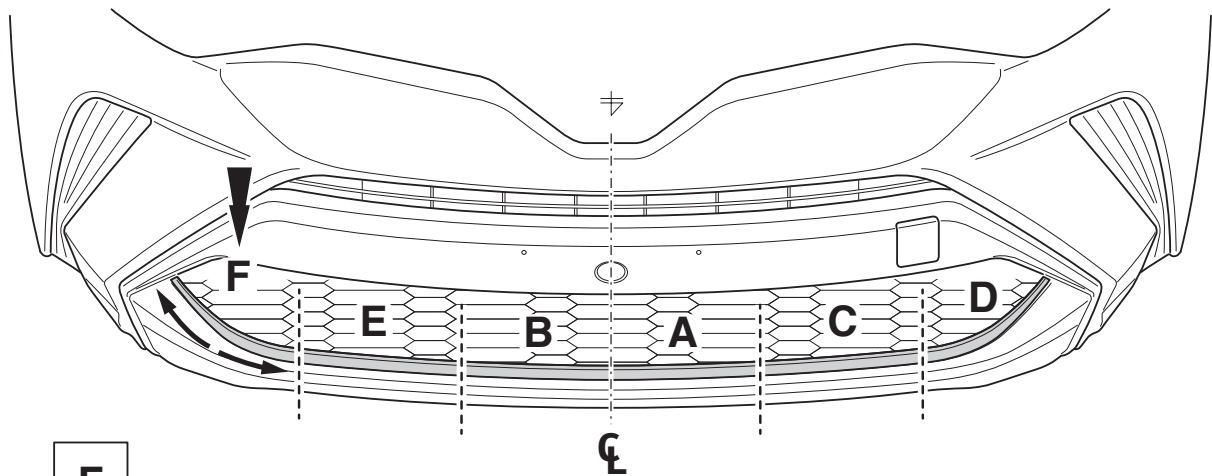

F

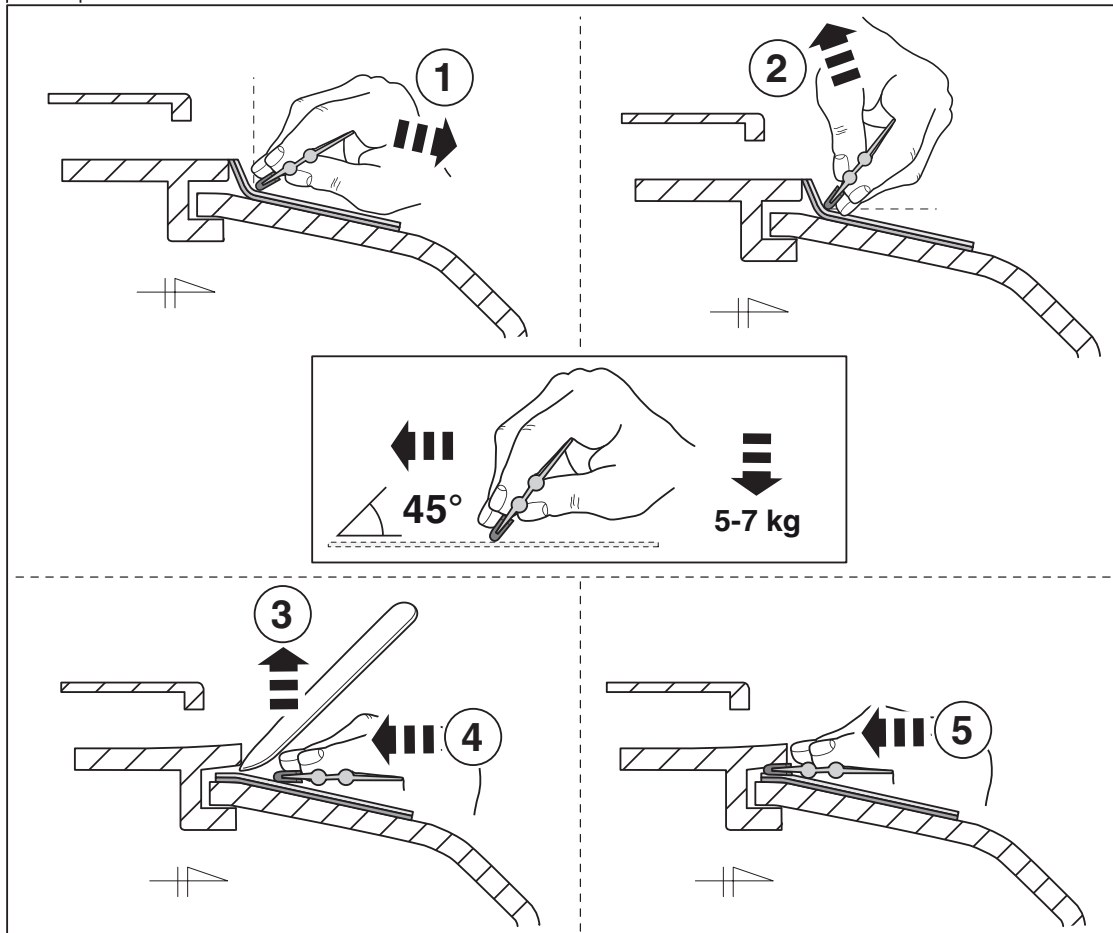

39

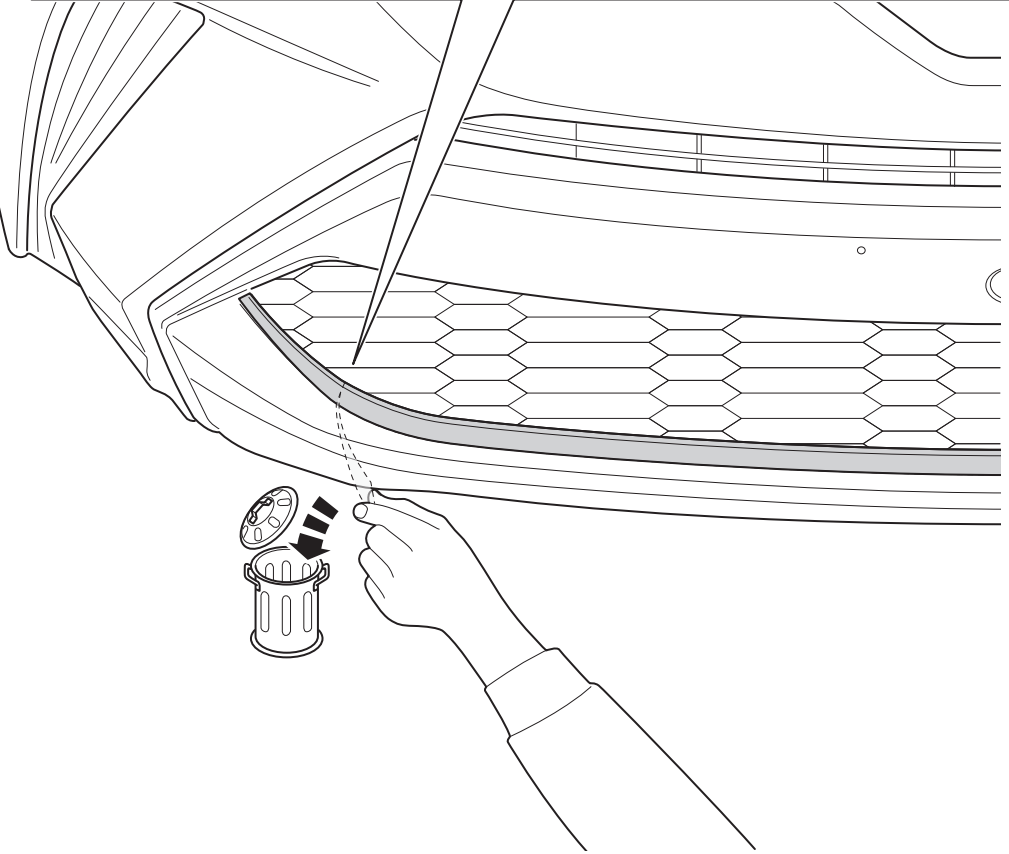
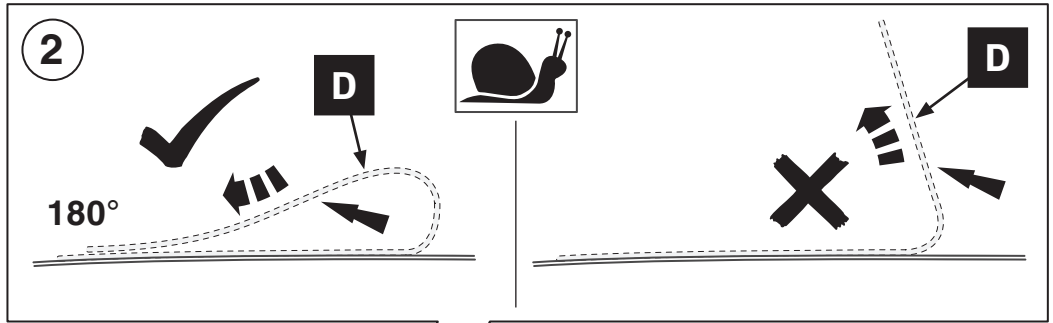
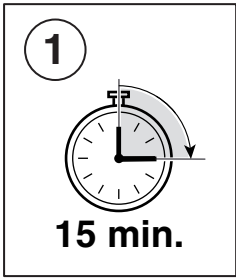

40

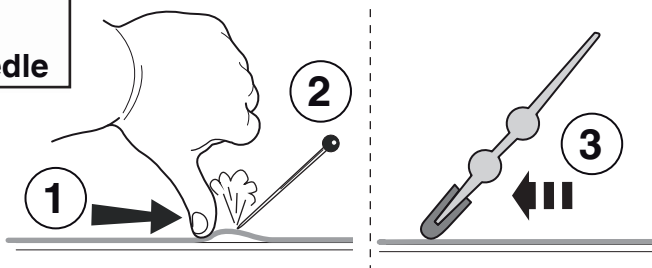
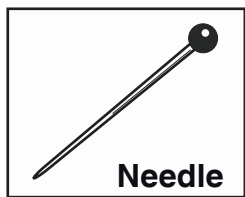
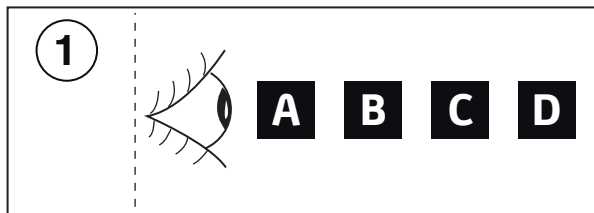
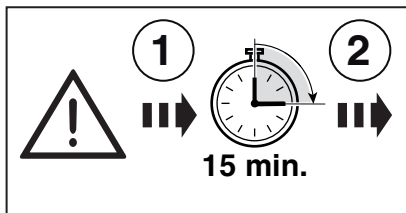

41

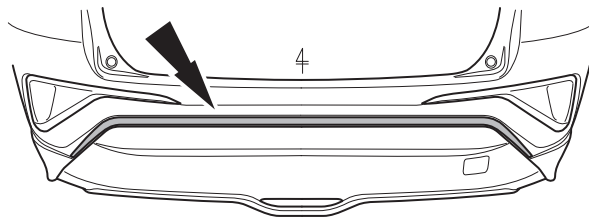
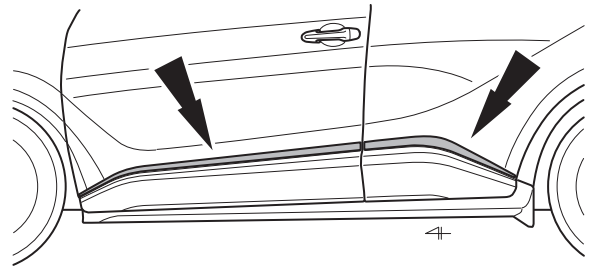
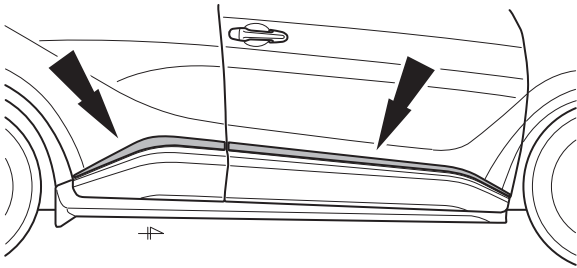
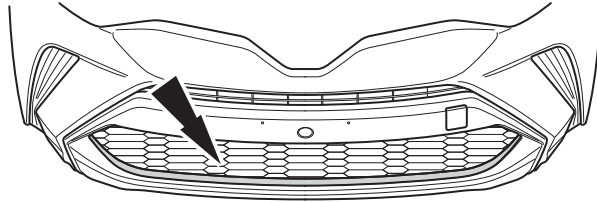
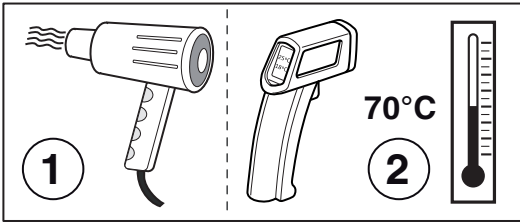

42

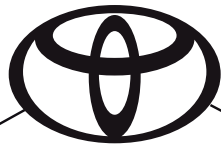

**TOYOTA**



15°C - 28°C

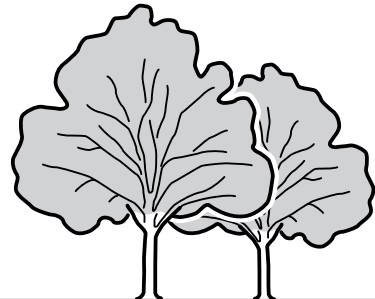
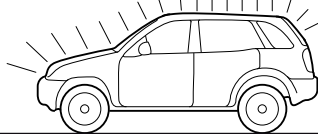

43

**TOYOTA C-HR  
2019/10**

**Exterior sticker decoration**

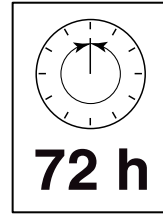
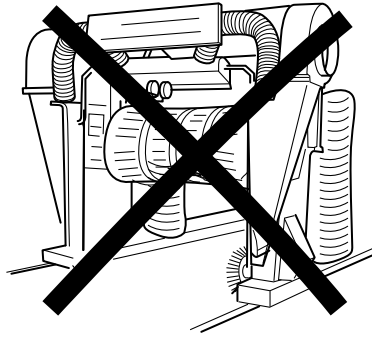
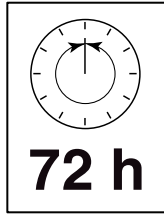

> 1 meter

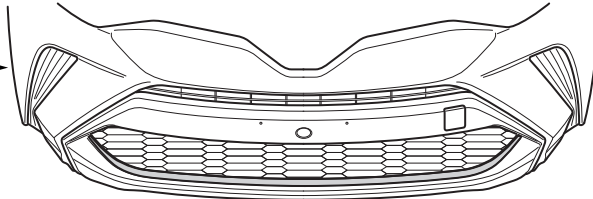

> 1 meter

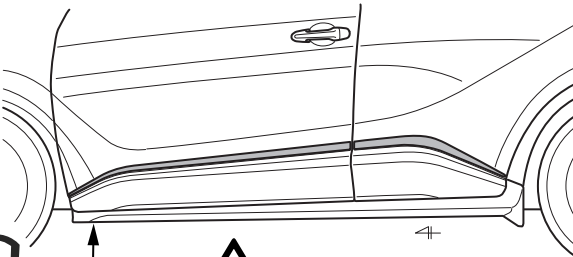
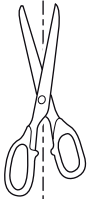
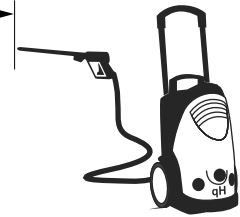
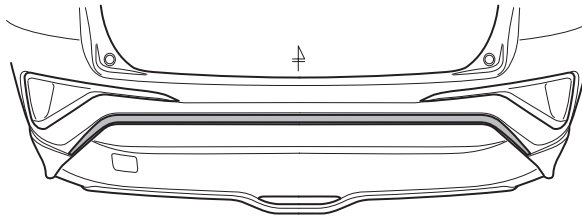

> 1 meter

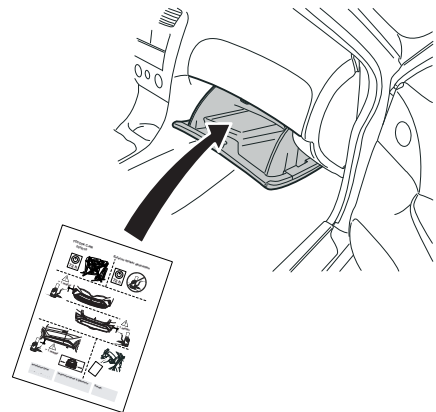
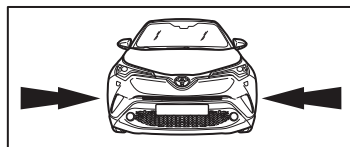
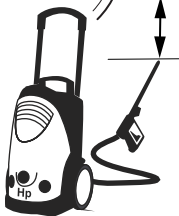

**Installation Date:**

.. / .. / ..

**Technician Name & Signature:**

**Stamp:**



**TOYOTA**

ALWAYS A  
BETTER WAY

# CHECK SHEET

Page 1 of 1

Model / Year **TOYOTA C-HR** Exterior sticker decoration  
2019/10

VIN n°

## DURING INSTALLATION

**1**

**P/N = OK**

**2**

**70°C**

**3**

**= OK**

## AFTER INSTALLATION

**1**

**2**

**= OK**

**Installation Date:**

... / ... / ...

**Technician Name & Signature:**

**Stamp:**

