



TOYOTA

ALWAYS A
BETTER WAY

Hilux

Decoration set, "Invincible"

Installation instructions

Model year: as from 2015/04

Vehicle code: GUN1***-D***HW
GUN1***-D***XW

Part number: PW18A-0K005

Manual reference number: AIM 005 087 - 0

Revision Record

Rev. No.	Date	Page	Step	Remarks

INVINCIBLE

A

2x

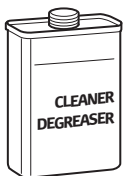
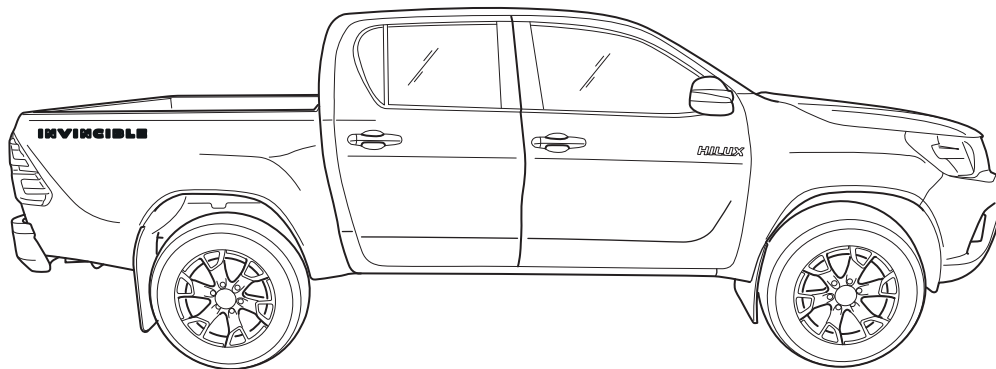
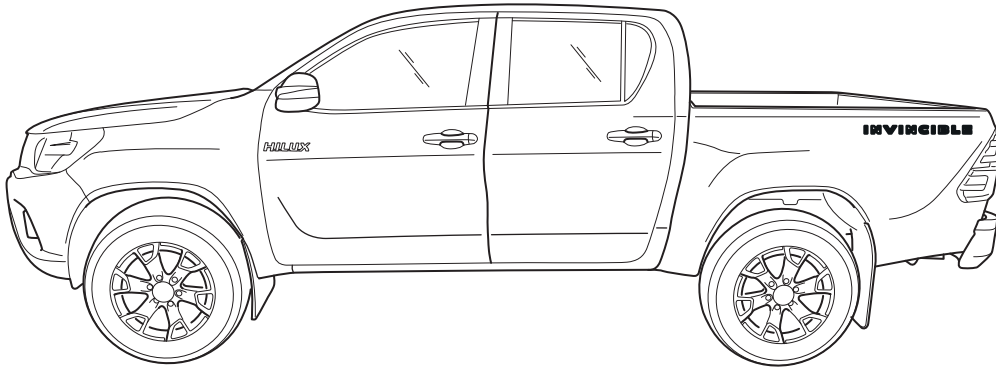

 **AIM 003-516-***

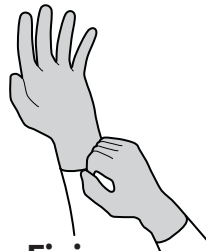
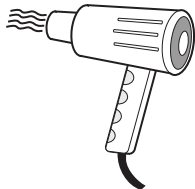

**Finixa
Nitril gloves**

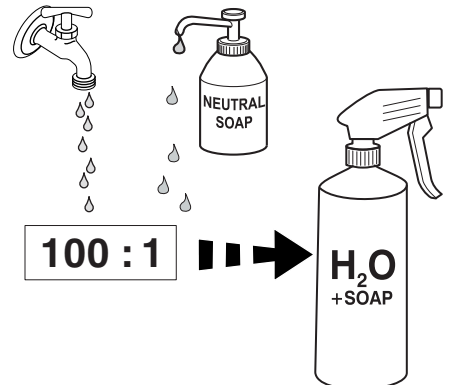

PZ438-00030-90



3m Gold Squeegee + Low Friction Sleeve
NOT INCLUDED





Material Safety Data Sheet

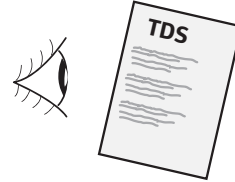

Technical Data Sheet

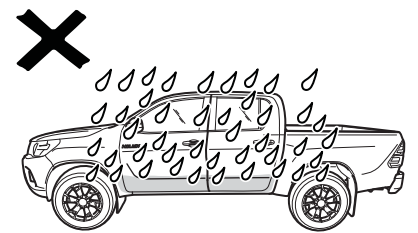
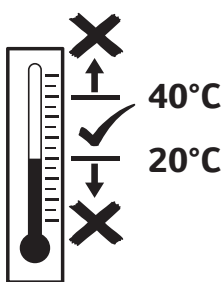
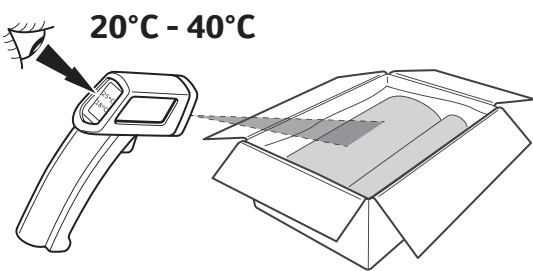
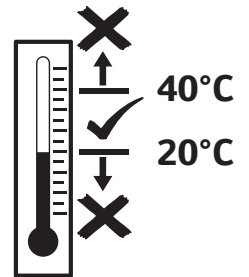
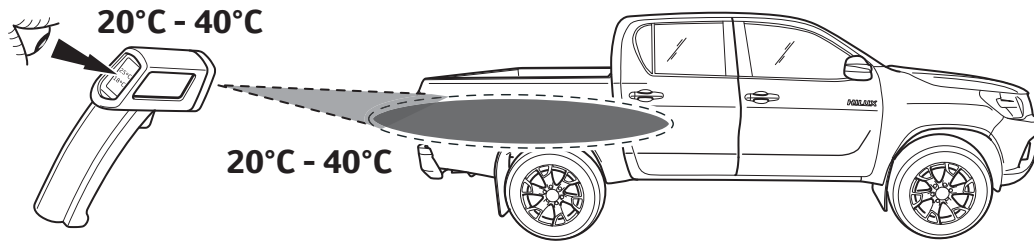
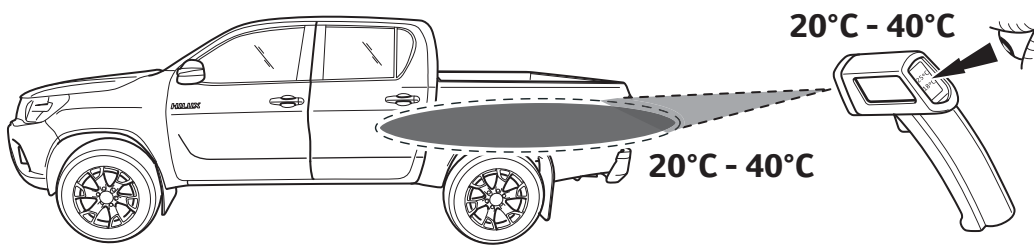

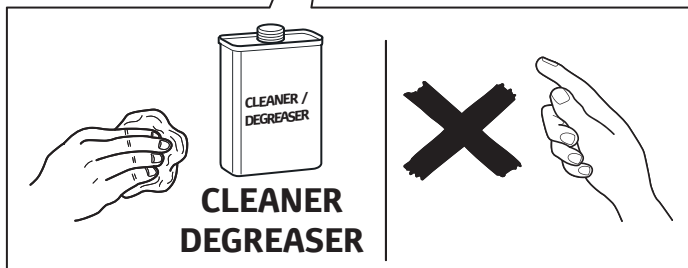
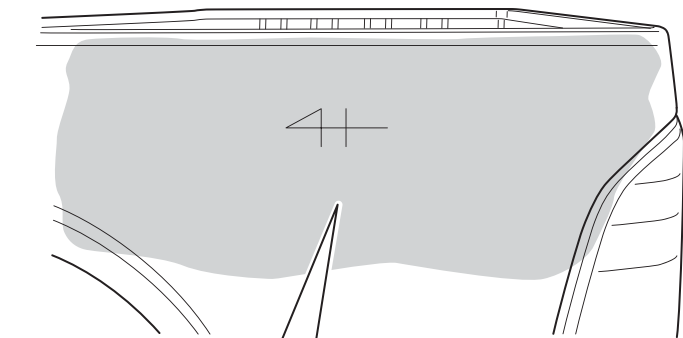
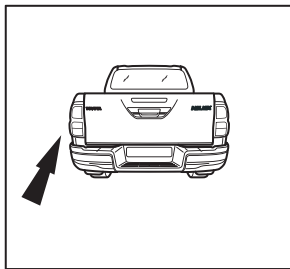



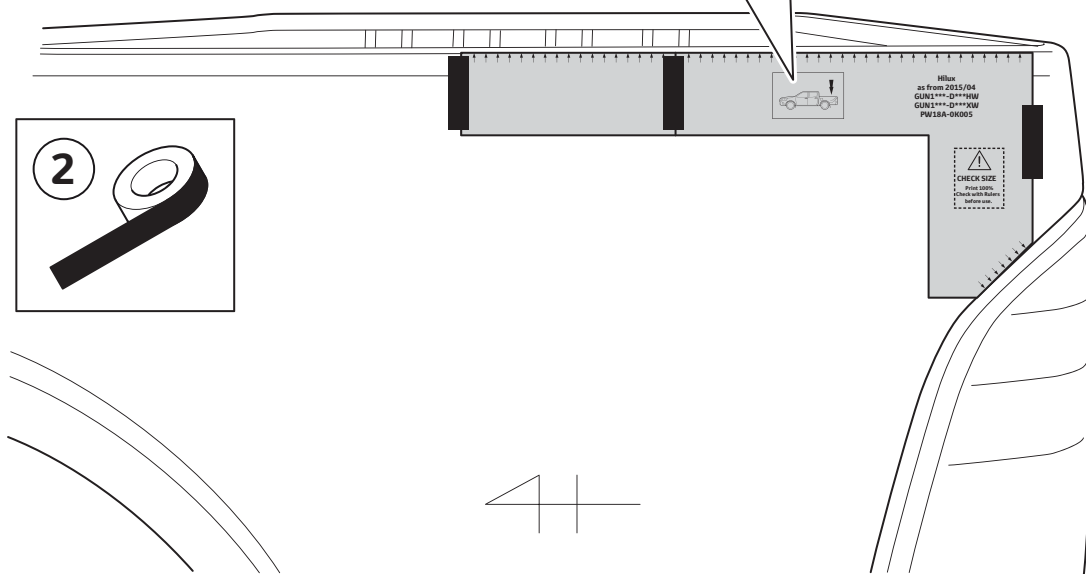
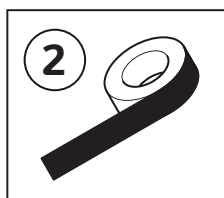
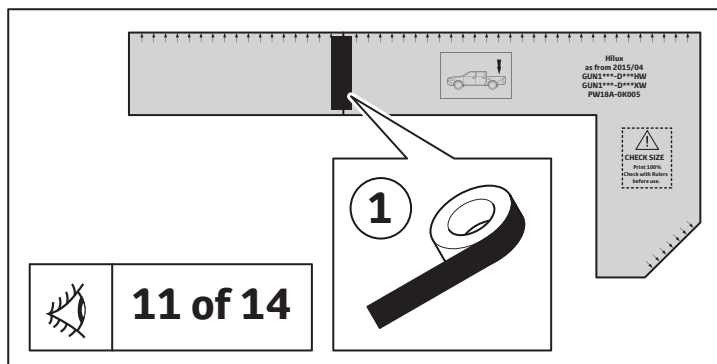

1



2

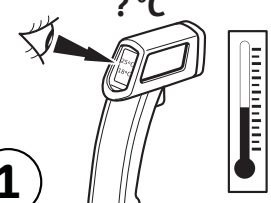
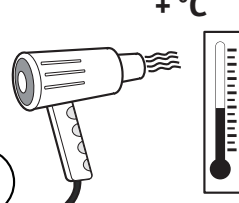
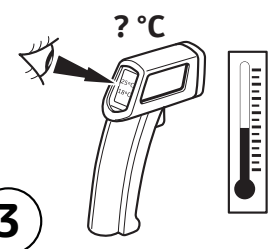



A

INVINCIBLE

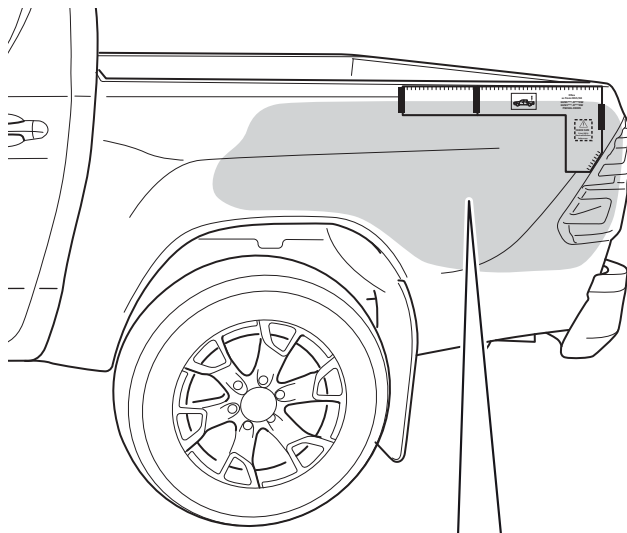
<p>1</p> 	<p>< 20°C → 2</p> <p>20°C < 40°C → 4</p>	<p>2</p> 
<p>3</p> 	<p>20°C < 40°C → 4</p>	<p>INFO</p>  <p>3 → 11</p>  

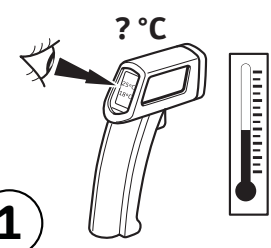
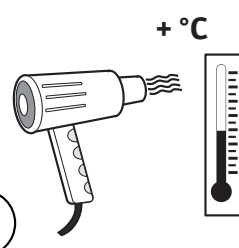
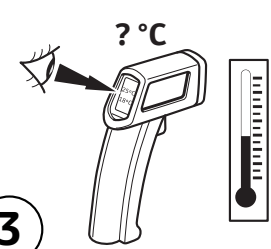
3



<p>1</p> 	<p>< 20°C → 2</p> <p>20°C < 40°C → 5</p>	<p>2</p> 
<p>3</p> 	<p>20°C < 40°C → 5</p>	<p>INFO</p>  <p>4 → 11</p>  

4

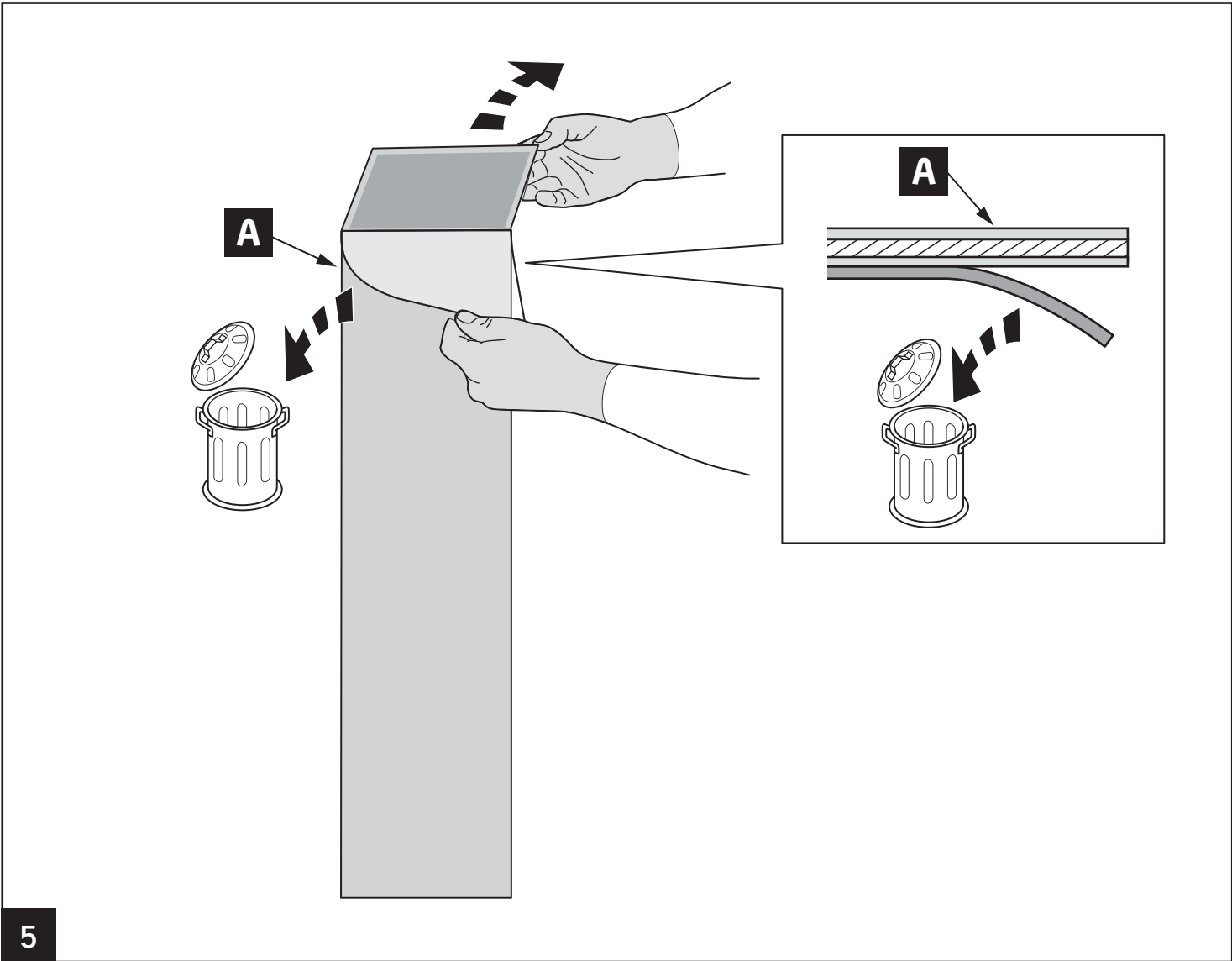

5

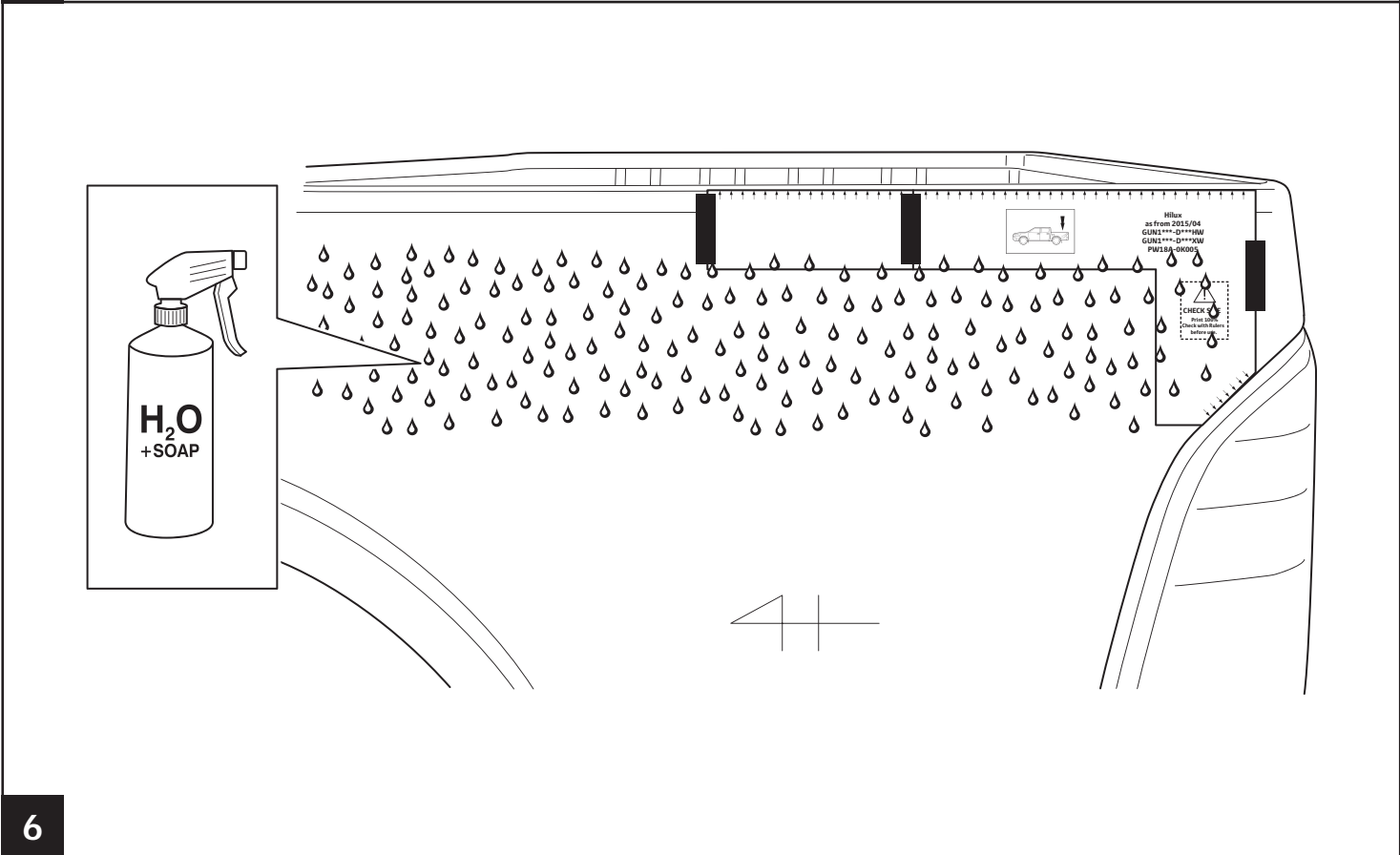

6

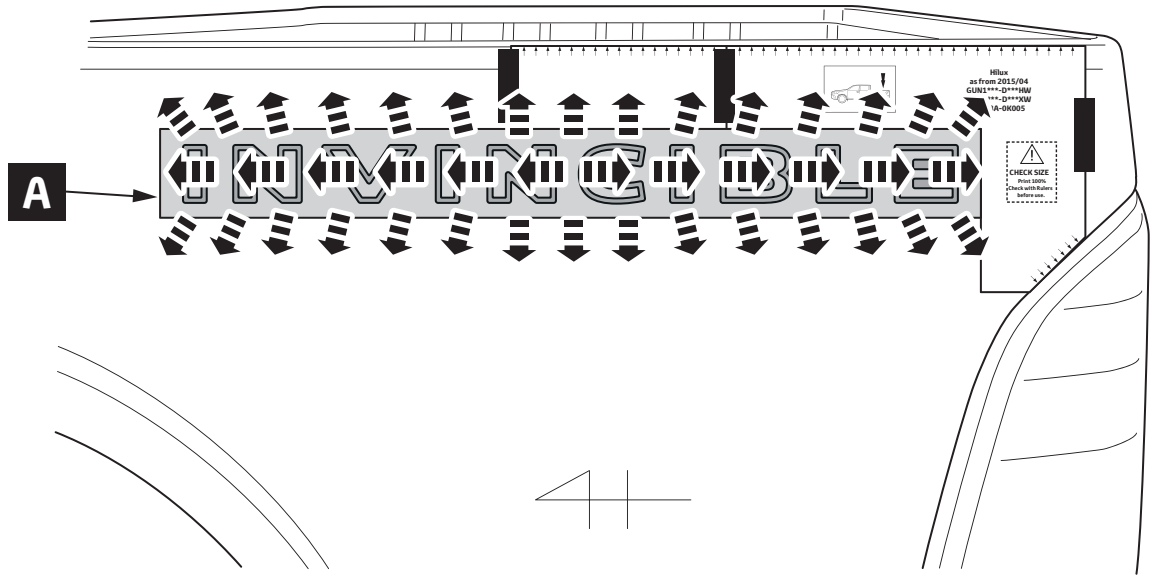
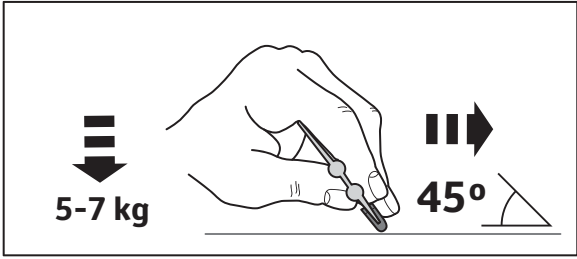

7

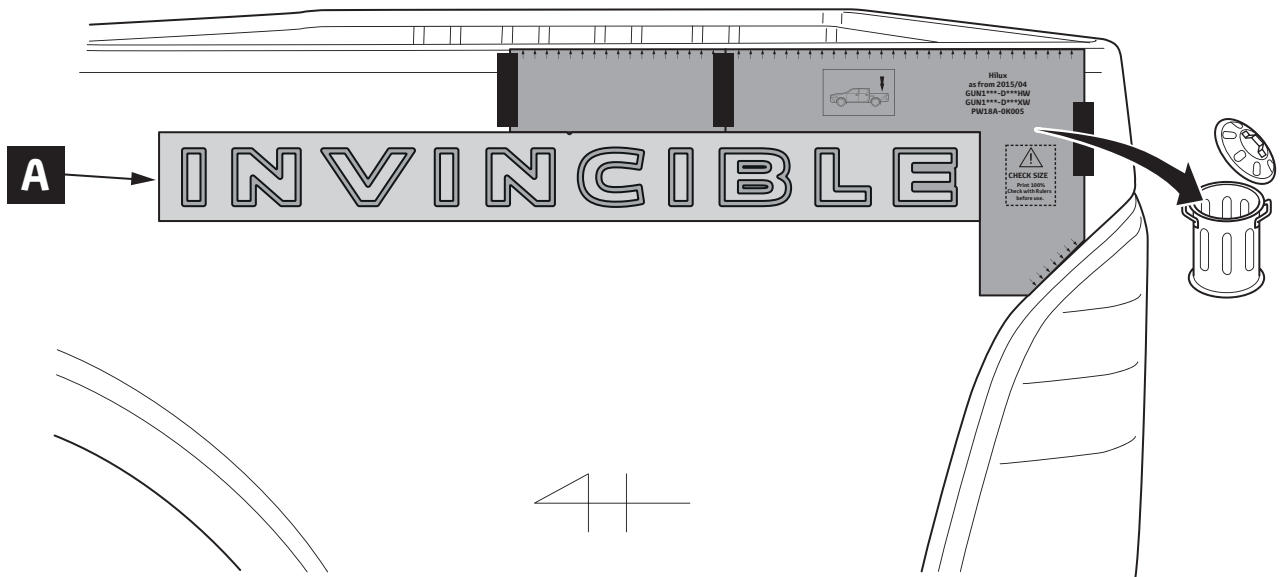

8

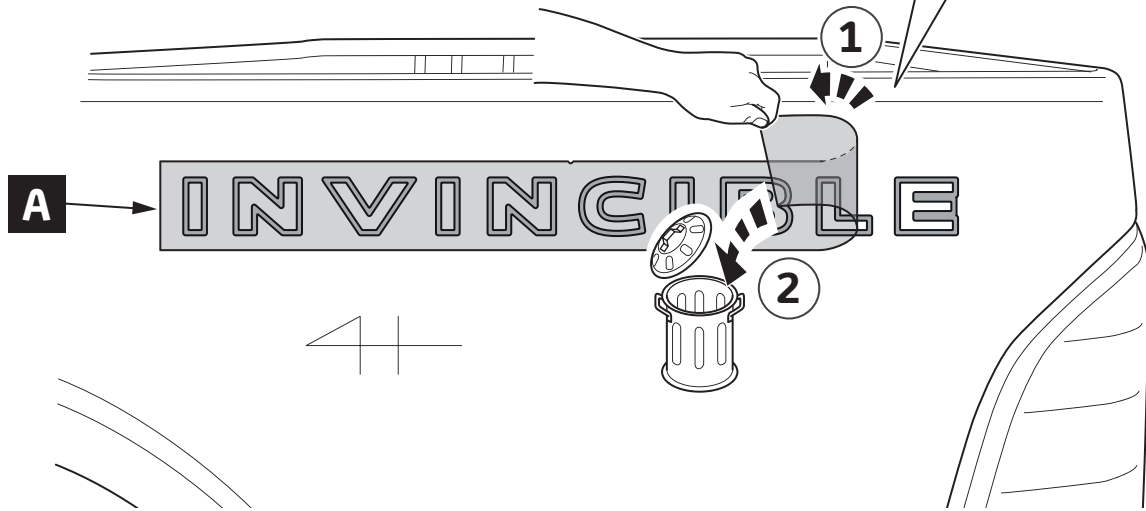
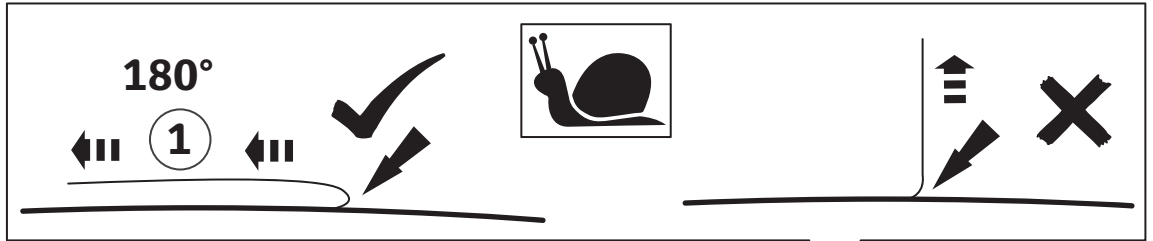

9

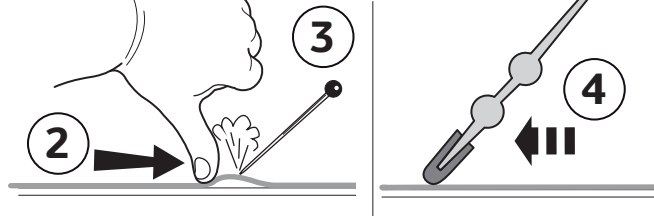
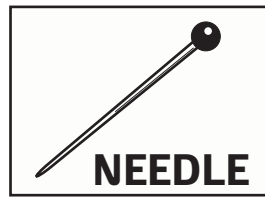
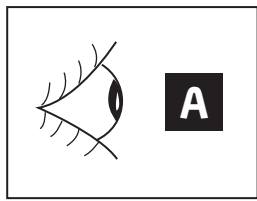
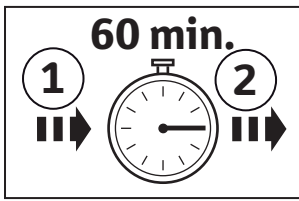

10

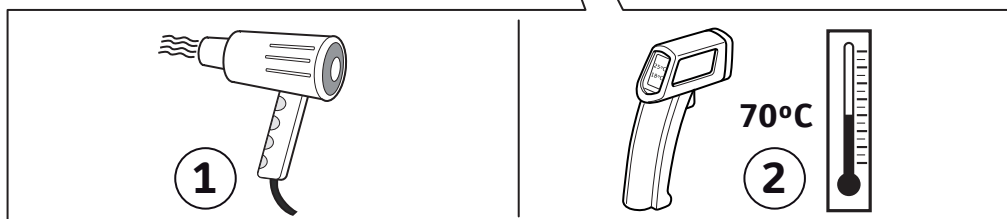
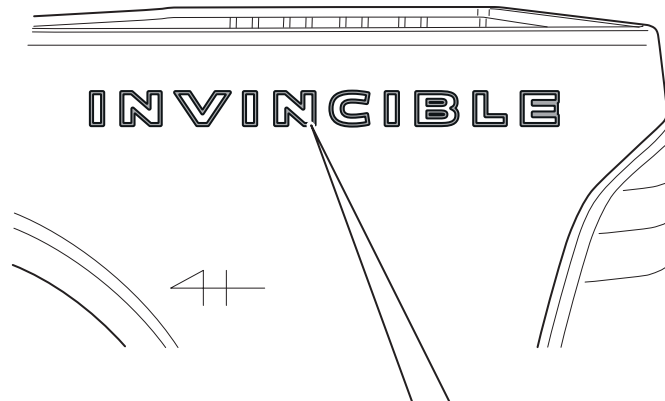

11

Fig.1 - Fig.11

Fig.1 - Fig.11

RHS = LHS

12

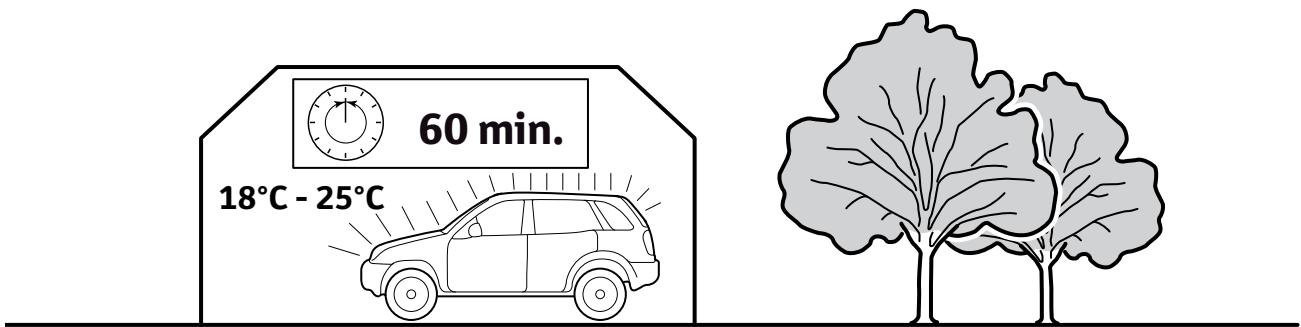

13



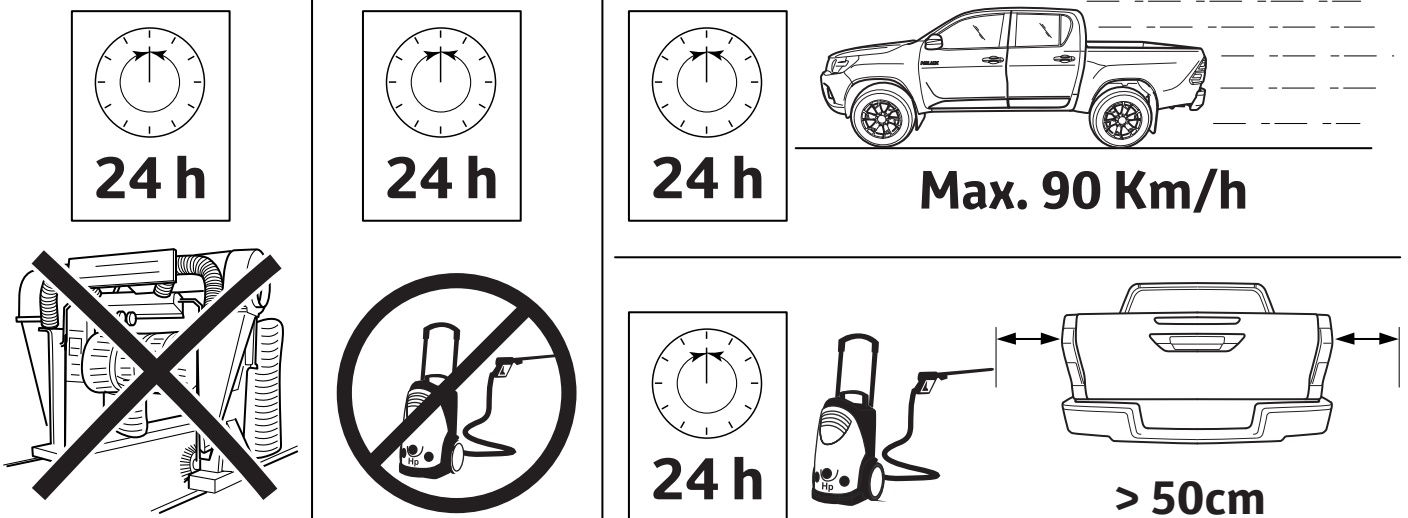

INFO



Hilux
as from 2015/04
GUN1*-D***HW**
GUN1*-D***XW**
PW18A-0K005

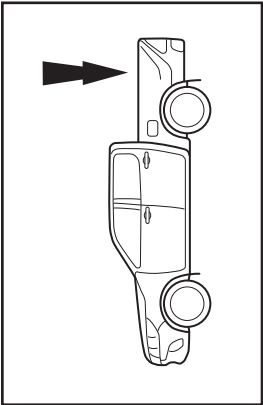

CHECK SIZE
 Print 100%
 Check with Rulers
 before use.



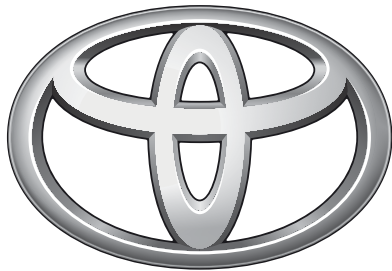





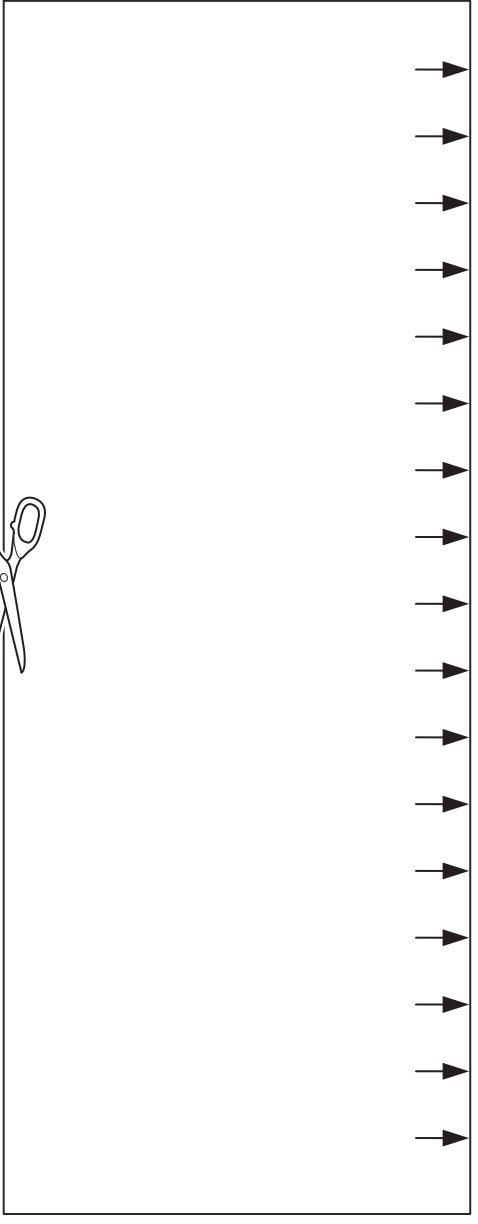
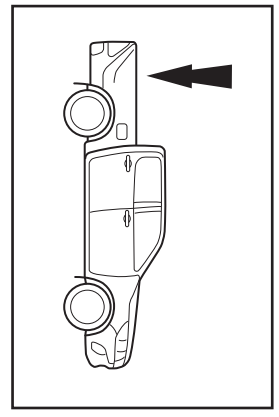
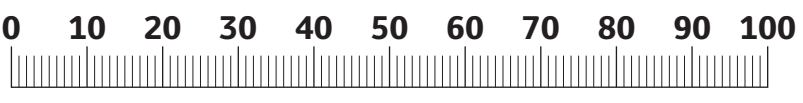
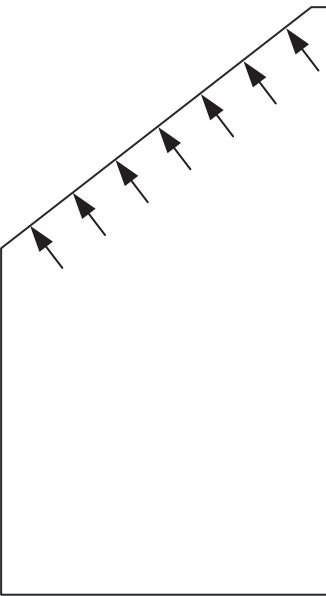

TOYOTA

Hilux
as from 2015/04
GUN1*-D***HW**
GUN1*-D***XW**
PW18A-0K005

CHECK SIZE
Print 100%
Check with Rulers
before use.



CHECK SHEET Page 1 of 1



TOYOTA

ALWAYS A
BETTER WAY

Model / Year Hilux
as from 2015/05

Decoration set
"Invincible"

VIN n°

DURING INSTALLATION

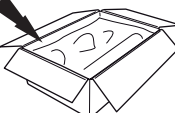
1  **P/N = OK** 

AFTER INSTALLATION

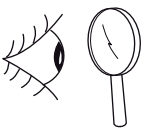
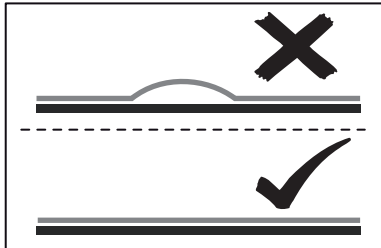
 **= OK** 

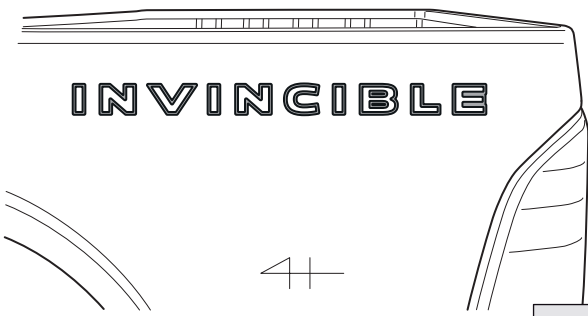

1

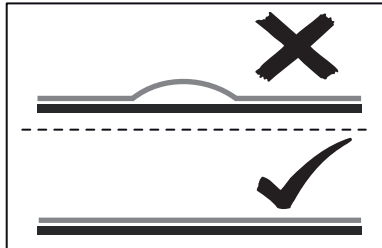
 **= OK** 

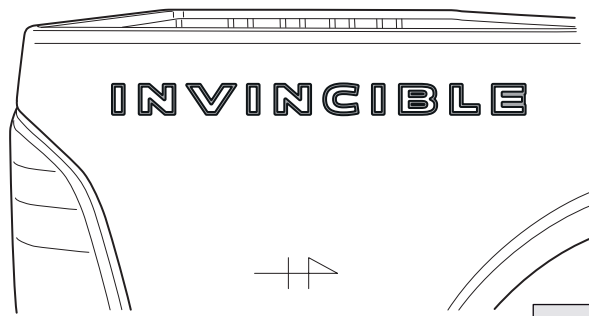

2

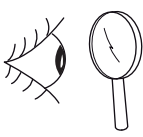
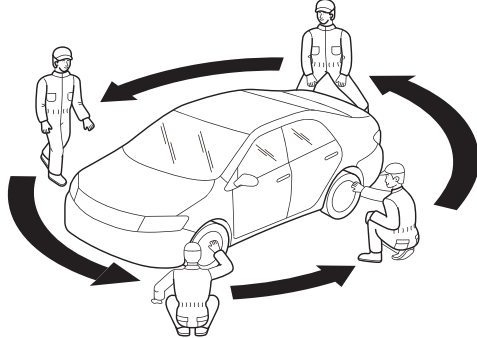
 **= OK** 

3

Installation Date:

.. / .. / ..

Technician Name & Signature:

Stamp: