



TOYOTA

ALWAYS A
BETTER WAY

Corolla (TS)

Front & rear set mudflaps









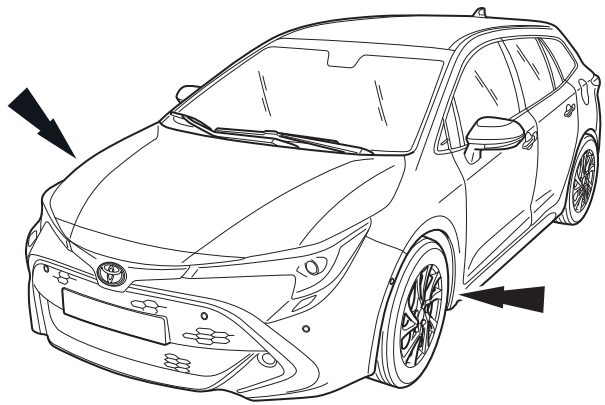
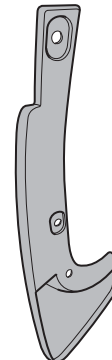
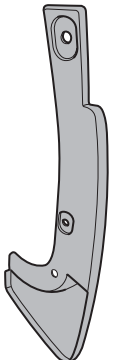
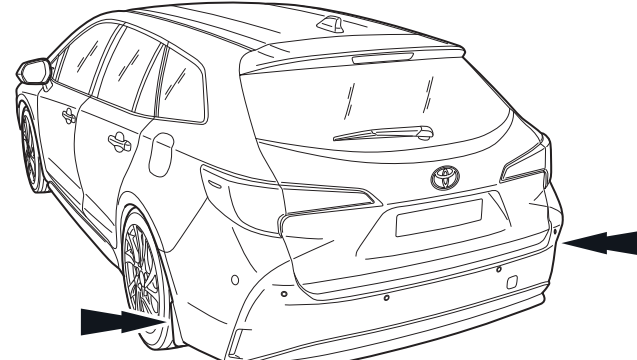
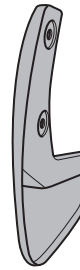
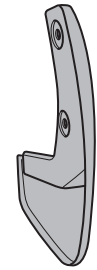

Installation instructions

Model year: 2019/02
Vehicle code: **E*1**-DH****
Part number: 53008-02060

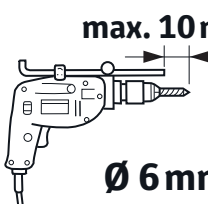
Manual reference number: AIM 004 357 - 1

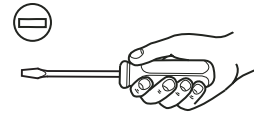
Revision Record

Rev. No.	Date	Page	Picture	Update	New	Deleted steps
1	14.11.18	4, 7-9	4, 5, 11, 12	X		

<p>A</p> 		 <p>1x</p>		
<p>B</p> 		 <p>1x</p>		
<p>C</p>  <p>8x</p>	<p>D</p>  <p>6x</p>	<p>E</p>  <p>6x</p>		
 <p>max. 10mm</p> <p>Ø 6mm</p>			 <p>10mm</p>	  <p>CLEANER / DEGREASER</p>  <p>AIM 003 516-*</p>

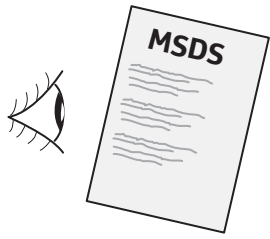

Material Safety Data Sheet

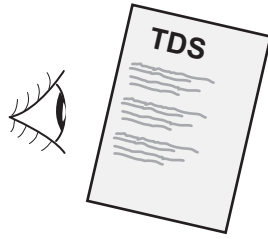

Technical Data Sheet

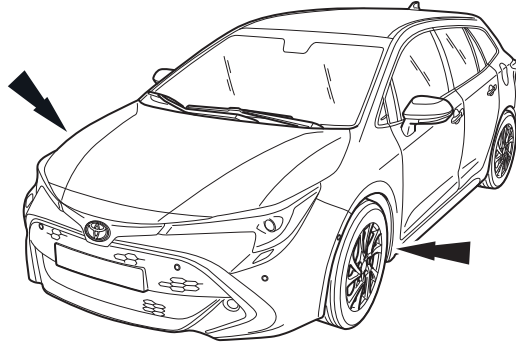
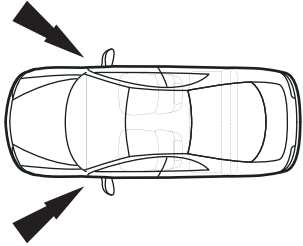
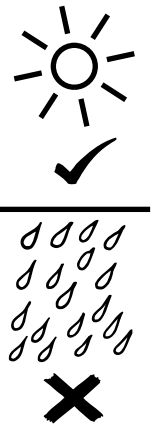

1

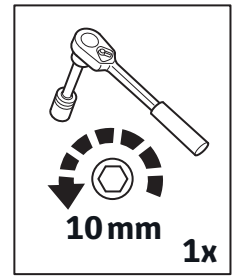
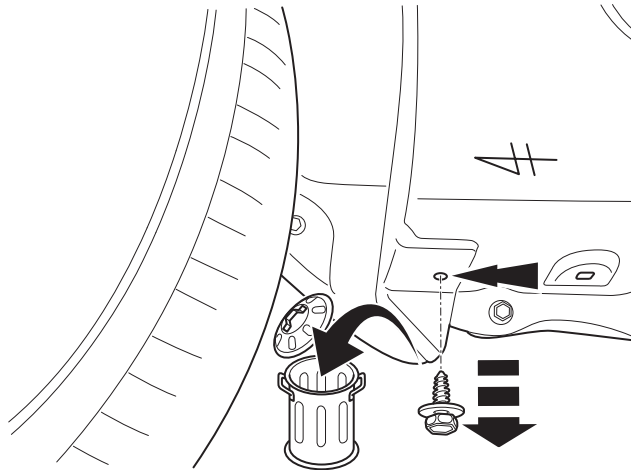
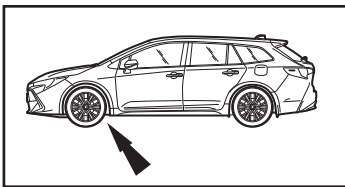

2

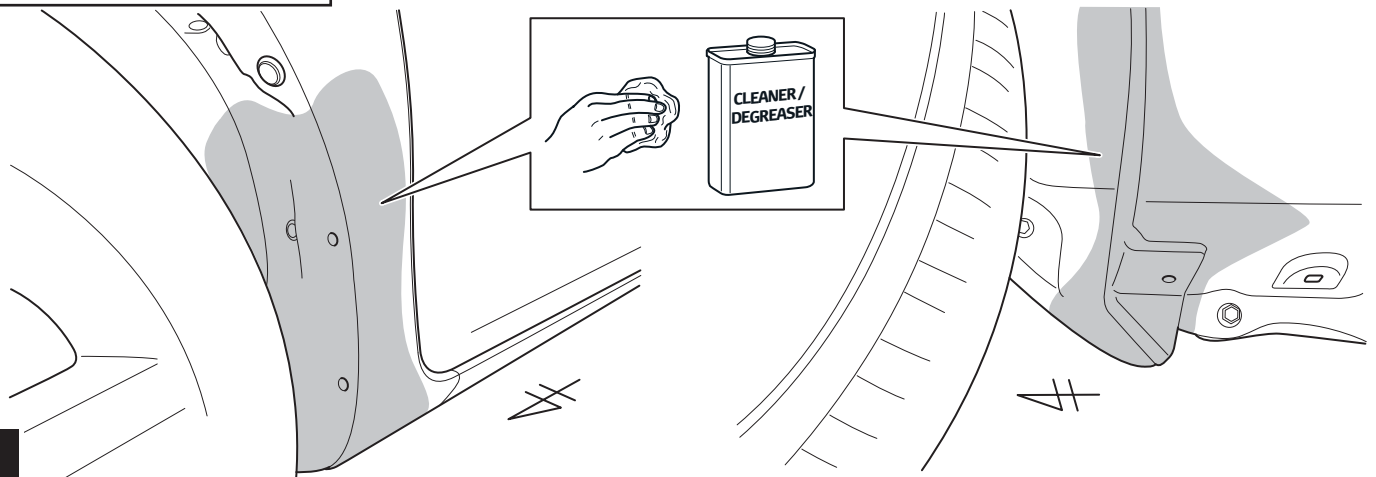
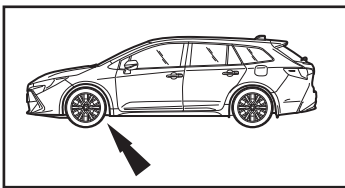

3

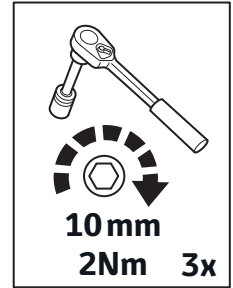
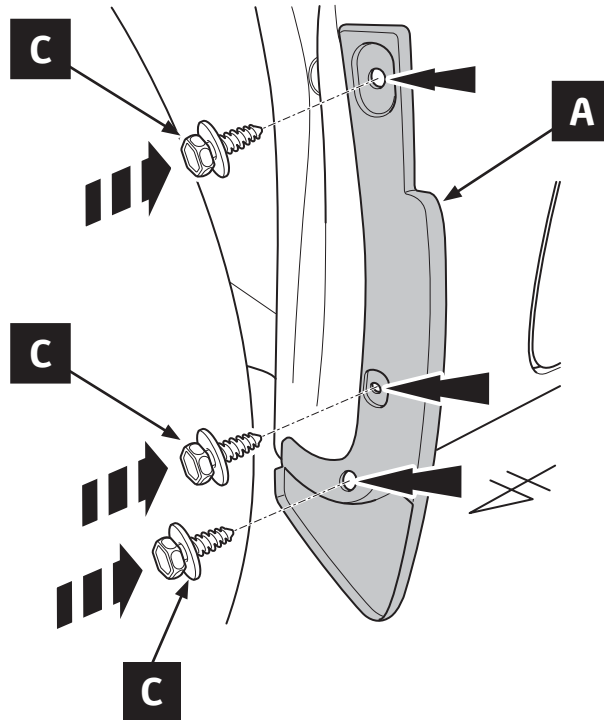
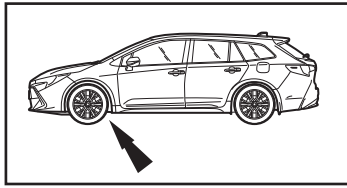

4

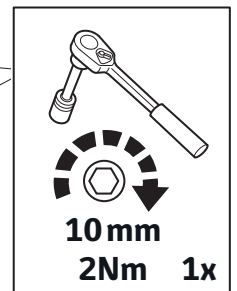
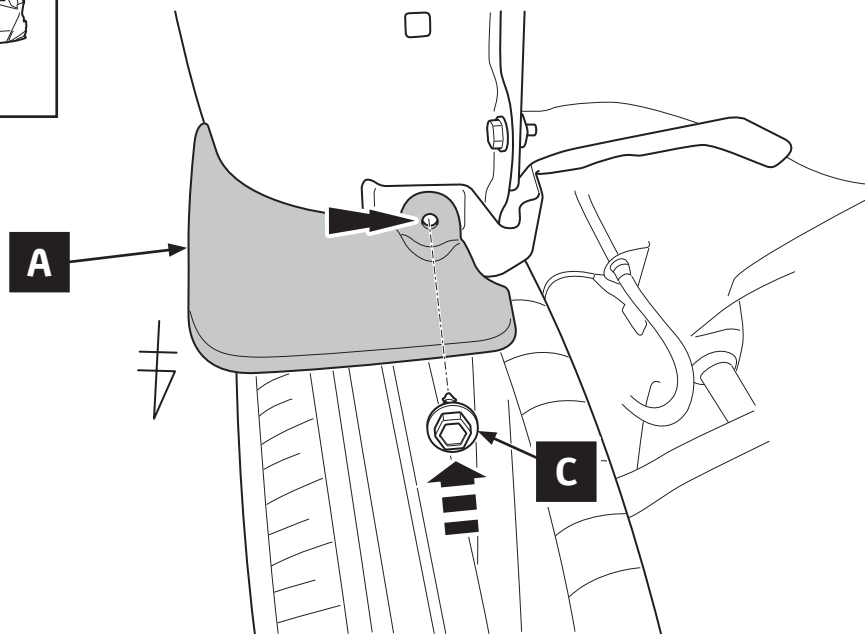
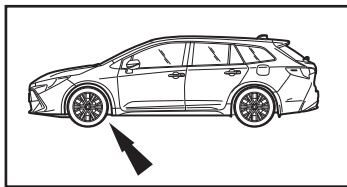

5

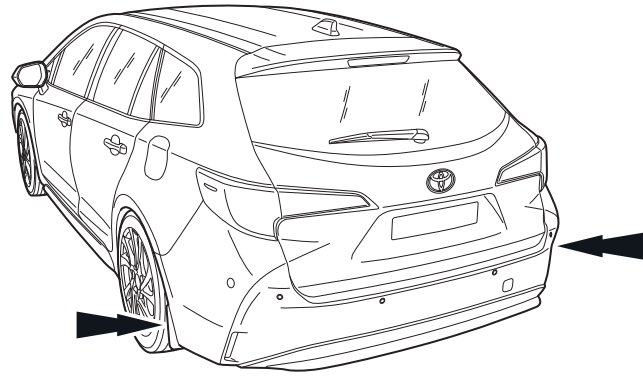
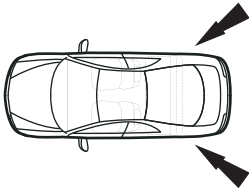

6

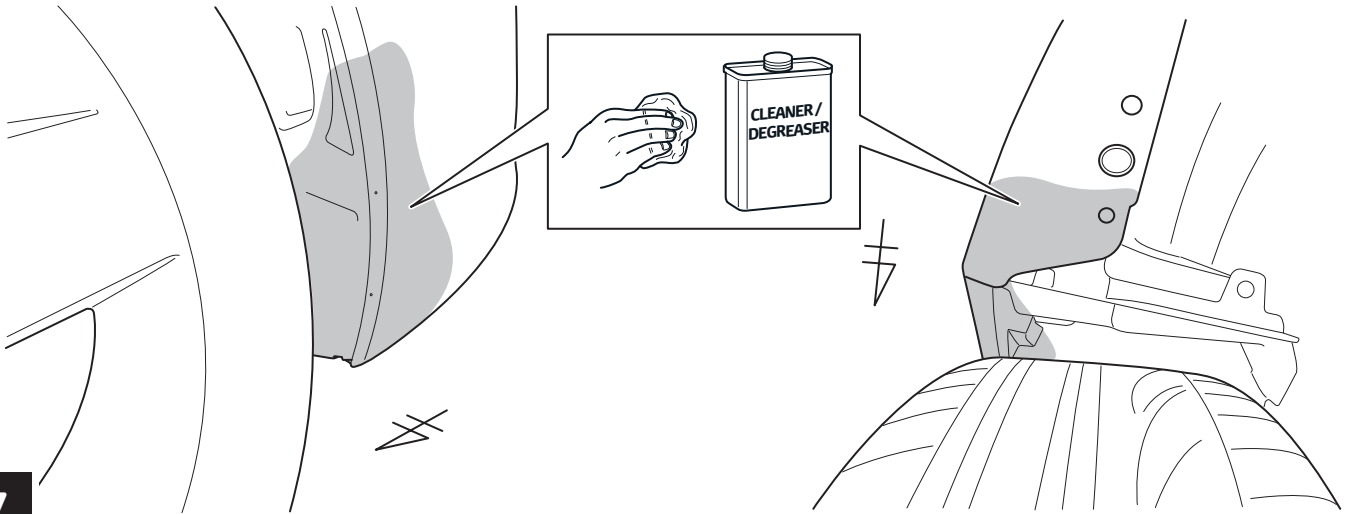
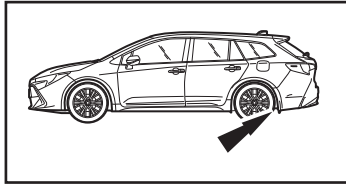

7

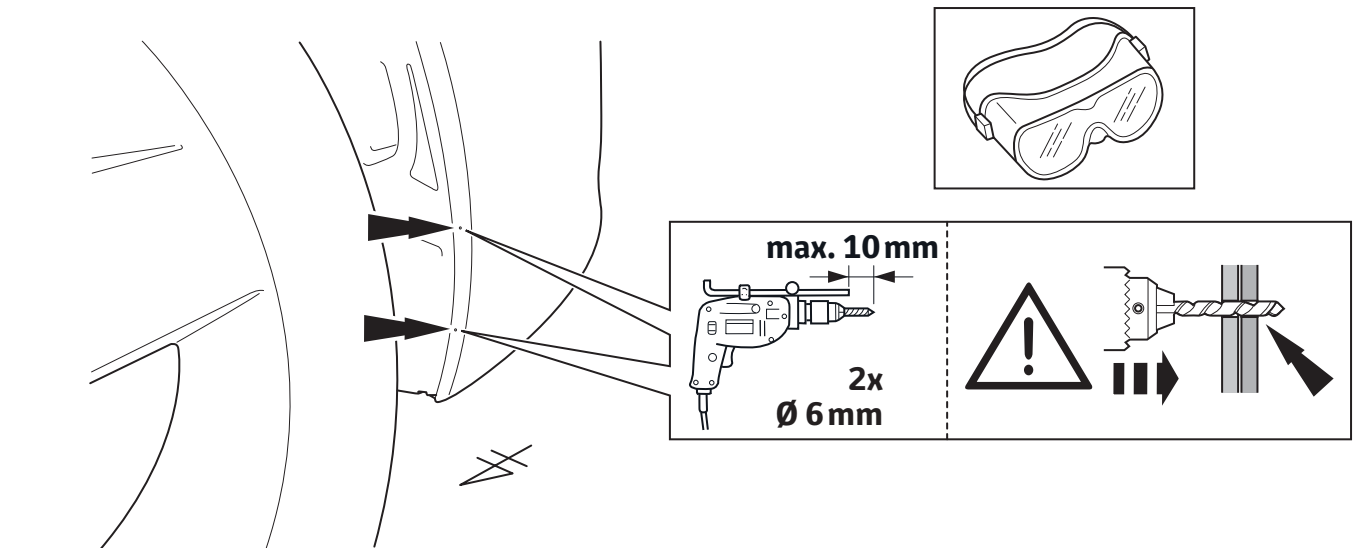
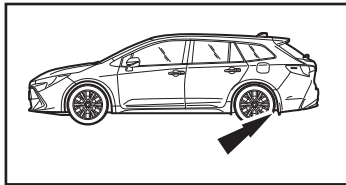

8

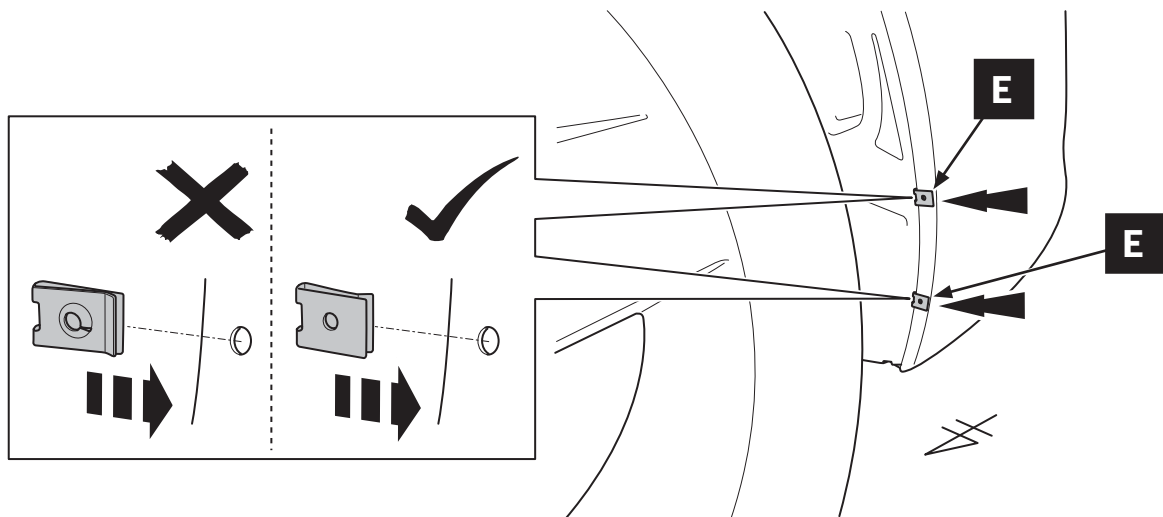
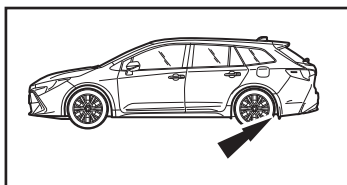

9

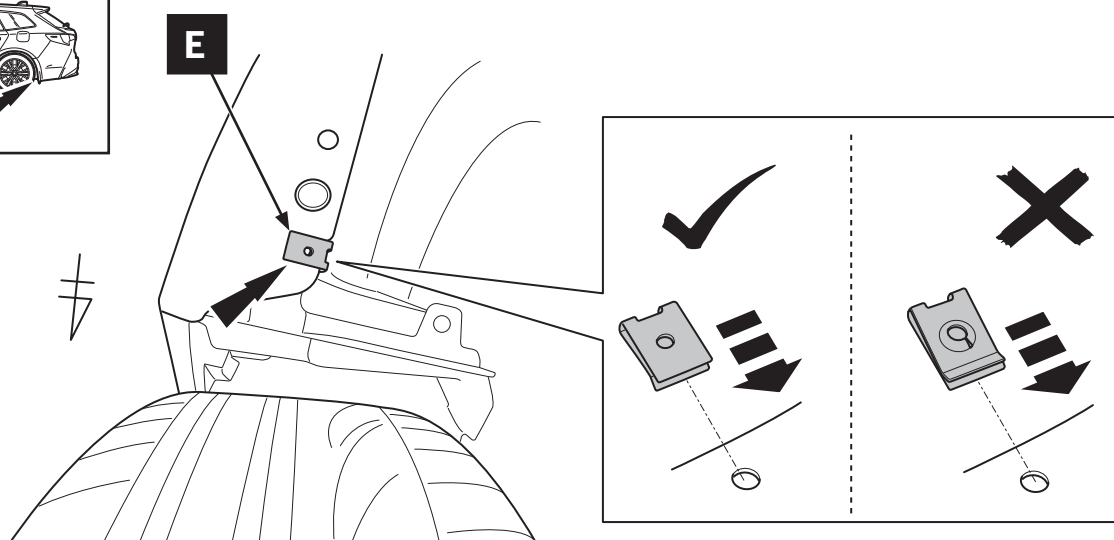
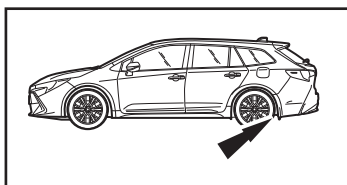

10

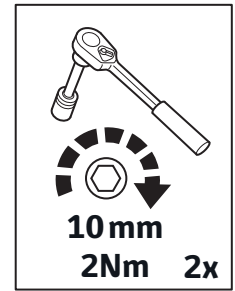
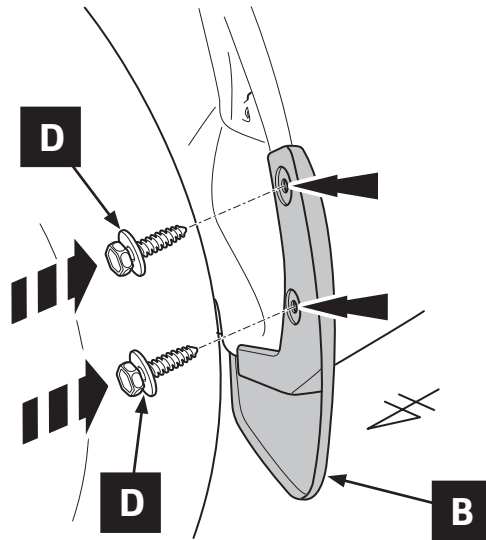
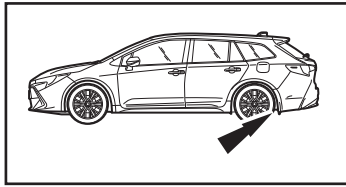

11

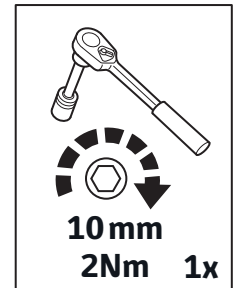
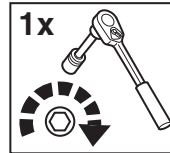
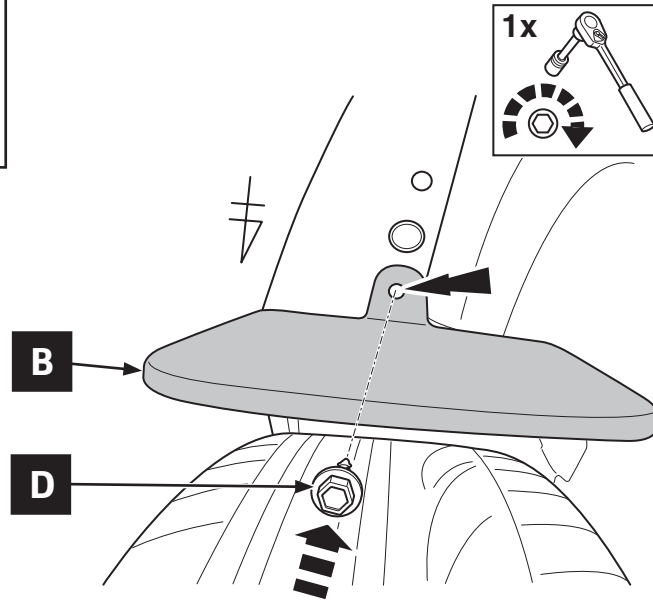
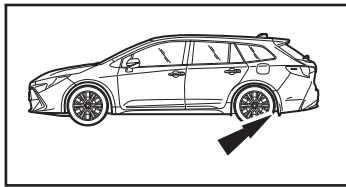

12

INFO



LHS

=



RHS

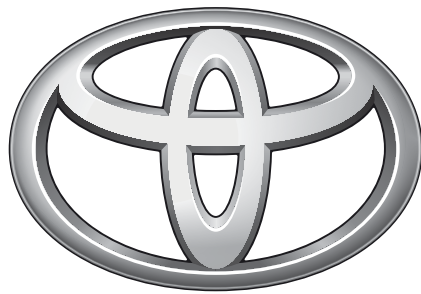

TOYOTA

CHECK SHEET



TOYOTA

Model / Year Corolla (TS)
2019/02

**Mud Flaps - Front
& Rear**

ALWAYS A
BETTER WAY

VIN n°

P/N = OK

LHS = RHS

2 Nm

CLICK

Serial Number

LHS = RHS

2 Nm

CLICK

Serial Number

= OK

Installation Date:

.. / .. / .. .

Technician Name & Signature:

Stamp: