



TOYOTA

ALWAYS A
BETTER WAY

Corolla (HB)

TPA Rear





Installation instructions





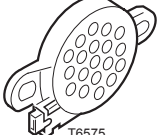
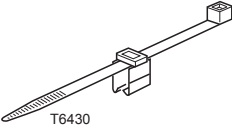
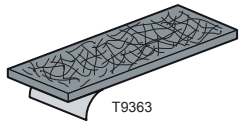
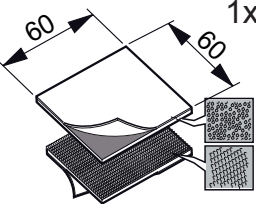
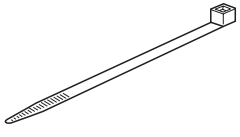
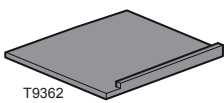
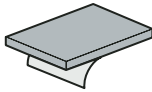
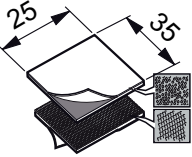

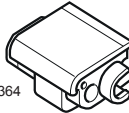
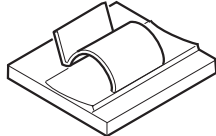
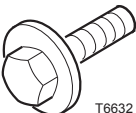
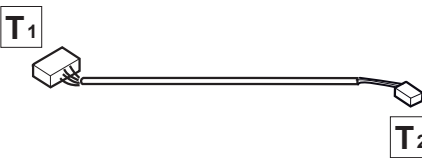
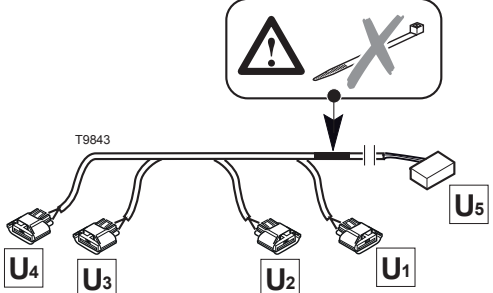
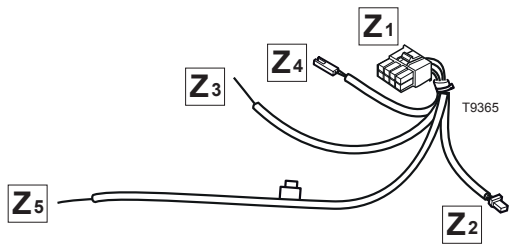
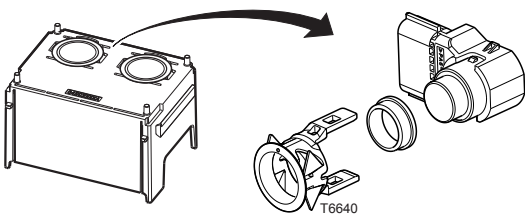

Model year:	2019/01	
Vehicle code:	*****-DW***W	
Part number:	PW501 - 02010	Main kit
	PW501 - 00700-** (x2)	Sensor kit
	PW501 - 00560 (x1) (Optional)	Rear cancellation switch

Manual reference number: AIM 004 317-4

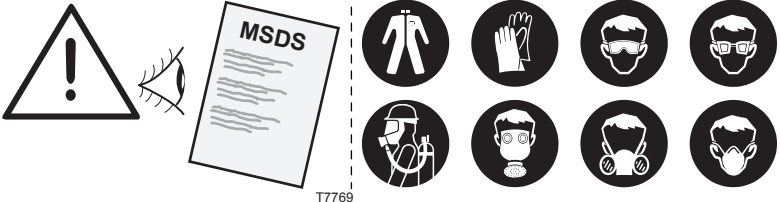
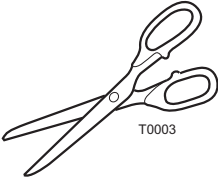
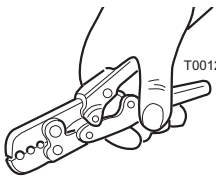
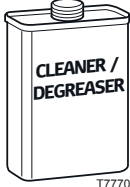
Revision record

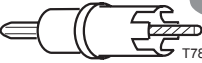
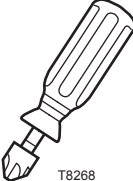
Rev. No.	Date	Page	Step	Remarks
△ ₁	06/03/2019	9	3	Battery terminal removal added
△ ₁	06/03/2019	10	4	Hooks removal added
△ ₁	06/03/2019	32-33	-	Check sheet updated
△ ₂	16/05/2019	33	-	Check sheet updated, diagnostic check added
△ ₃	28/06/2019	27	24	Step updated
△ ₄	04/09/2019	33	-	Check sheet updated

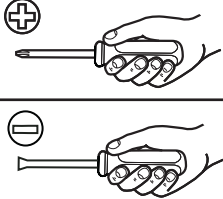
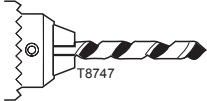
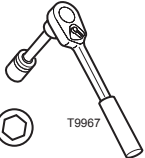
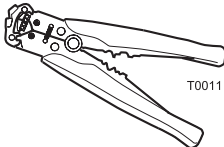
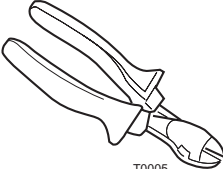
<p>A</p>  <p>1x</p> <p>T6574</p>	<p>B</p>  <p>1x</p> <p>T6575</p>	<p>C</p>  <p>4x</p> <p>T6430</p>	<p>D</p>  <p>1x</p> <p>T9363</p>
<p>E</p>  <p>1x</p> <p>60 60</p> <p>T9362</p>	<p>F</p>  <p>45x</p> <p>T6430</p>	<p>G</p>  <p>1x</p> <p>T9362</p>	<p>H</p>  <p>1x</p> <p>T9362</p>
<p>I</p>  <p>1x</p> <p>25 35</p> <p>T9362</p>	<p>J</p>  <p>1x</p> <p>T6640</p>	<p>L</p>  <p>1x</p> <p>T9364</p>	<p>O</p>  <p>1x</p> <p>T9362</p>
<p>P</p>  <p>1x</p> <p>T6632</p>		<p>T</p>  <p>T1 T2</p>	
<p>U</p>  <p>T9843</p> <p>U5 U4 U3 U2 U1</p>	<p>Z</p>  <p>Z1 Z2 Z3 Z4 Z5</p> <p>T9365</p>		
<p>N</p>  <p>2x</p> <p>T6640</p> <p>PW501-00700-00</p>	<p>M</p> <p>OPTIONAL</p>  <p>1x</p> <p>T7093</p> <p>PW501-00560</p>		

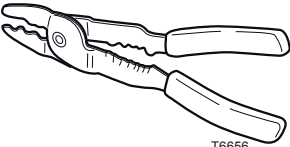
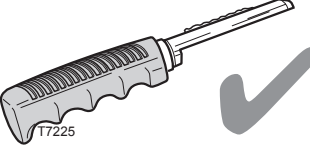
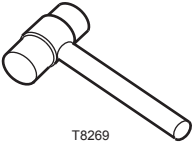
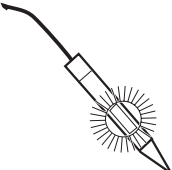
 <p>T0001</p>	 <p>T0007</p>	 <p>T7769</p>		
 <p>T0003</p>	 <p>T0012</p>	 <p>T7770</p> <p>AIM 003 516-*</p>	 <p>T6239</p>	 <p>T7771</p>
<p>Ø 20 mm ✓</p>  <p>T7834</p>	<p>T6114 Ø 20 mm</p> <p>PZ415-OJGA1-00</p>	 <p>T8268</p>	 <p>T1094</p>	 <p>T3851</p>
 <p>T8747</p> <p>Ø 2 mm Ø 20 mm</p>	 <p>T9967</p> <p>10 mm 12 mm 14 mm</p>	 <p>T0011</p>	 <p>T0005</p>	 <p>T8352</p>
 <p>T6656</p>	<p>T6075</p> <p>PZ415-OJGA2-00</p>	 <p>T7225</p> <p>PZ415-OJGS2-00</p>	 <p>T8269</p>	
 <p>T6029</p>				

EN

- Expert Fitment Required.
- To avoid damage to the wiring harness, ensure contact with sharp edges is prevented.
- Install parts as shown on illustrations.
- Re-fit panels, ensure that the wiring harness and other components are neatly and securely located.

DE

- Montage durch Fachwerkstatt erforderlich.
- Zur Vermeidung von Beschädigungen an der Kabelisolierung ist Berührung mit scharfen Kanten zu vermeiden.
- Teile gemäß Abbildung montieren.
- Paneele wieder anbringen; achten Sie darauf, dass der Kabelbaum und andere Teile ordnungsgemäß und genau positioniert sind.

ES

- Montaje sólo por el concesionario.
- A efectos de evitar desperfectos en el aislamiento del cable, hay que evitar el contacto con aristas cortantes.
- Montar las piezas tal como se indica en las figuras.
- Volver a colocar los paneles; preste atención a que el mazo del cable y las demás piezas tengan la posición correcta y precisa.

FR

- Montage par spécialiste nécessaire.
- Eviter tout contact avec des arêtes vives afin de ne pas endommager l'isolation des câbles.
- Monter les pièces selon les figures.
- Remettre le panneau; veillez à ce que le faisceau et les autres pièces soient positionnés correctement et avec la précision requise.

IT

- E' necessario in officina specializzata.
- Allo scopo di evitare danni all'isolazione dei cavi, evitare di metterli a contatto con spigoli acuti.
- Montare le parti secondo quanto rilevabile delle illustrazioni.
- Rimettere in posizione i pannelli; far ben attenzione che il fascio di cavi e le altre parti siano state posizionate con esattezza e nella dovuta maniera.

PT

- Especialista em montagem requerido.
- Para não se danificar a isolamento dos cabos, é conveniente evitar-se contacto com arestas afiadas.
- Monte as partes conforme ilustrado.
- Tornar a colocar os painéis; verificar se a árvore de cabos e outras peças estão na posição exacta e prescrita.

NL

- Montage door vakman nodig.
- Ter vermindering van beschadiging aan de isolatie van de elektrokit dient contact met scherpe kanten te worden vermeden.
- Delen overeenkomstig afbeelding monteren.
- Panelen weer monteren; let erop, dat de kabelboom en andere delen correct en netjes gepositioneerd worden.

DA

- Montage ved professionelt værksted påkrævet.
- Berøring med skarpe kanter skal undgås for at undgå beskadigelse af kabelisoleringen.
- Dele skal monteres i henhold til illustrationer.
- Paneler fastgøres igen; vær opmærksom på, at kabelsamlingen og andre dele placeres korrekt og præcist.

NO

- Nødvendig med montering fra fagvegverksted.
- For å unngå skader på kabelisoleringen må berøring av skarpe kanter unngås.
- Monter alle deler i henhold til illustrasjonene.
- Monter panelene igjen, og pass på at kabelbunten og andre deler er anbrakt ordentlig og på riktig sted.

SV

- Verkstadsmontage erfordras.
- För att förhindra skador på ledningarnas isolation skall beröring med vassa kanter undvikas.
- Montera detaljerna enligt figurerna
- Sätt tillbaka panelerna igen; kontrollera noga att ledningsmattan och andra detaljer ligger på rätt plats.

FI

- Asennus tarpeen merkkikorjaamossa.
- Pidä huoli myös siitä, että kaapelointi on korin kiinnityksen myötäinen ja kiinnitetty huolellisesti muihin liikkuviin osiin.
- Asenna osat kuvien mukaan.
- Aseta paneelit paikalleen; tarkista, että kaapelointi ja muut osat ovat asianmukaisesti ja tarkalleen paikoillaan.

CS

- Montáž ve specializované dílně nutná.
- Zabraňte tomu, aby se kabely poškodily tím, že jsou položeny na ostrých hranách.
- Montujte části podle vyobrazení
- Opět připevněte panely; dbejte na to, aby svazek kabelů a ostatní části byly uloženy na správném místě.

HU

- A szereléshez szakmühely kell.
- A kábelszigetelés megsérülésének elkerülésére ügyeljen arra, hogy a kábel ne juthasson érintkezésbe éles peremű alkatrészekkel.
- Az alkatrészeket az ábrák szerint szerelje be.
- Szerelje vissza a fedőlapokat, ügyeljen arra, hogy a ábelek és a többi alkatrészek pontosan a számukra kijelölt helyen maradjanak.

PL

- Konieczny montaż przez warsztat specjalistyczny.
- Dla zapobieżenia uszkodzeniu izolacji chronić przed zetknięciem z ostrymi krawędziami.
- Zamontować części zgodnie z rysunkiem.
- Na powrót osadzić osłony; zadbać aby wiązka kablowa i inne części były właściwie i dokładnie ułożone.

EL

- Να τοποθετεί από συνεργείο.
- Για να αποφευχθούν ζημιές στη μόνωση καλωδίων, να αποφεύγεται η επαφή των με αιχμηρές ακμές.
- Τοποθέτηση των μερών σύμφωνα με τις Εικόνες.
- Τοποθετήστε πάλι το κάλυμμα· προσοχή, η πλεξούδα καλωδίων και άλλα μέρη να είναι τοποθετημένα ακριβώς και σύμφωνα με τους κανονισμούς.

RU

- Монтаж должны выполнять специалисты в мастерской
- Во избежание повреждений изоляции кабеля не допускать соприкосания с острыми углами
- Монтировать части согласно иллюстрации
- Установить панель, проверить правильность и точность расположения кабелей и других частей.

TR

- Uzmanın takması gereklidir.
- Kablo demetinin hasar görmemesi için, sivri objelerle temasını engellenmesini sağlayın.
- Parçaları çizimlerde gösterildiği gibi takın.
- Panoları tekrar takın, kablo demeti ve diğer komponentlerin tam ve sıkıca yerleşmesini sağlayın.

BG

- Изисква се поставяне от специалист.
- За избягване на повреди по кабелния сноп се уверете, че няма контакт с остри ръбове.
- Монтирайте частите според показаното на илюстрацията.
- Поставете отново панелите, уверете се, че кабелният сноп и останалите компоненти са разположени подредено и надеждно.

ET

- Paigaldada spetsialisti poolt.
- Juhtmestiku kahjustamise vältimiseks hoidke juhtmed eemal teravatest servadest.
- Paigaldage osad vastavalt joonistele.
- Paigaldage kattepaneelid; veenduge, et juhtmestik ja muud osad on paigutatud korrektselt ning kindlalt.

LV

- Nepieciešami īpaši saliekamie elementi.
- Lai nesabojātu elektroinstalāciju, nepieskarieties tai ar asiem priekšmetiem.
- Uzstādiet detaļas, kā parādīts attēlos.
- Uzlieciet paneļus, raugieties, lai elektroinstalācija un citas daļas būtu kārtīgi un stingri nofiksētas.

LT

- Būtina, kad sumontuotų specialistas.
- Tam, kad išvengtumėte įvado apgadinimo, saugokite, kad laidai nesiliestų prie aštrių briaunų.
- Sumontuokite dalis taip, kaip pavaizduota iliustracijoje.
- Į vietas įdėkite skydelius, patikrinkite, ar laidų šarvai ir kiti komponentai yra savo vietose ir gerai pritvirtinti.

RO

- Este necesară instalarea de către un specialist.
- Pentru a evita deteriorarea cablajului, evitați contactul cu muchiile ascuțite.
- Montați componentele așa cum este prezentat în figuri.
- Reinstalați panourile, aveți grijă de plasarea îngrijită și în condiții de siguranță a cablajului și a celorlalte componente.

SL

- Potrebna je strokovna montaža.
- Da preprečite poškodbe kableskega snopa, preprečite stik z ostrimi robovi.
- Dele namestite, kot je prikazano na slikah.
- Ponovno montirajte panele in zagotovite, da so kabelski snop in druge komponente nameščene varno.

SK

- Vyžaduje sa profesionálne vybavenie.
- Káblové zväzky sa nesmú dotýkať ostrých okrajov, aby sa nepoškodili.
- Dielce založte tak, ako je znázornené na obrázkoch.
- Založte panely a uistite sa, že káblové zväzky a iné dielce sú bezpečne a prehľadne uložené.

	EN	DE	ES	FR	IT	PT	NL	DA	NO	SV	FI	CS
L	Blue	Blau	Azul	Bleu	Blu	Azul	Blauw	Blå	Blå	Blå	Sininen	Modrá
B	Black	Schwarz	Negro	Noir	Nero	Preto	Zwart	Sort	Sort	Svart	Musta	Černá
BR	Brown	Braun	Marrón	Marron	Marrone	Castanho	Bruin	Brun	Brun	Brun	Ruskea	Hnědá
DL	Dark blue	Dunkelblau	Azul oscuro	Bleu foncé	Blu scuro	Azul-escuro	Donkerblauw	Mørkeblå	Mørkeblå	Mørkblå	Tummansininen	Tmavomodrá
DG	Dark green	Dunkelgrün	Verde oscuro	Vert foncé	Verde scuro	Verde-escuro	Donkergroen	Mørkegrøn	Mørkegrønn	Mörkgrön	Tummanvihreä	Tmavozelená
G	Green	Grün	Verde	Vert	Verde	Verde	Groen	Grøn	Grønn	Grön	Vihreä	Zelená
GR	Grey	Grau	Gris	Gris	Grigio	Cinzeno	Grijs	Grå	Grå	Grå	Harmaa	Šedá
LA	Lavender	Lavendel	Lavanda	Lavande	Lavanda	Lavanda	Lavendel	Lavendel	Lavendel	Lavendel	Laventeli	Levandulová
LB	Light blue	Hellblau	Azul claro	Bleu clair	Blu chiaro	Azul-claro	Lichtblauw	Lyseblå	Lyseblå	Ljusblå	Vaaleansininen	Bleděmodrá
LG	Light green	Hellgrün	Verde claro	Vert clair	Verde chiaro	Verde-ciaro	Lichtgroen	Lysegrøn	Lysegrønn	Ljusgrön	Vaaleanvihreä	Světlezelená
NO	Natural colour	Naturfarben	Color natural	Nature	Colori naturali	Cores naturais	Naturel	Naturfarvet	Naturfarger	Naturfärger	Luonnonväri	Přírodní barva
O	Orange	Orange	Naranja	Orange	Arancione	Laranja	Oranje	Orange	Orange	Orange	Oranssi	Oranžová
P	Pink	Rosa	Rosa	Rose	Rosa	Rosa	Rosé	Rosa	Rosa	Rosa	Rosa	Růžová
R	Red	Rot	Rojo	Rouge	Rosso	Vermelho	Rood	Rød	Rød	Röd	Punainen	Červená
PU	Purple	Purpur	Púrpura	Pourpre	Rosso porpora	Púrpura	Paars	Purpur	Purpur	Purpur	Purppura	Purpurová
SB	Sky blue	Himmelblau	Azul cielo	Bleu ciel	Celeste	Azul-céu	Hemelsblauw	Himmelblå	Himmelblå	Himmelsblå	Taivaansininen	Blankytná
T	Yellow brown	Gelbbraun	Amarillo-marrón	Marron-jaune	Giallomarrone	Castanho-amarelado	Geelbruin	Gulbrun	Gulbrun	Gulbrun	Keltaisenruskea	Žlutohnědá
W	White	Weiß	Blanco	Blanc	Bianco	Branco	Wit	Hvid	Hvit	Vit	Valkoinen	Bílá
Y	Yellow	Gelb	Amarillo	Jaune	Giallo	Amarelo	Geel	Gul	Gul	Gul	Keltainen	Žlutá
V	Violet	Violett	Violeta	Violet	Viola	Violeta	Violet	Violet	Fiolett	Violett	Violett	Fialová

	HU	PL	EL	RU	TR	BG	ET	LV	LT	RO	SL	SK
L	Kék	Niebieska	Μπλε	Синий	Mavi	Синьо	Sinine	Zils	Mélyna	Albastru	Modra	Modrá
B	Fekete	Czarna	Μαύρο	Чёрный	Siyah	Черно	Must	Melns	Juoda	Negru	Črna	Čierna
BR	Barna	Brazzowa	Καφέ	Коричневый	Kahverengi	Καφяво	Pruun	Brūns	Ruda	Maro	Rjava	Hnědá
DL	Sötétkék	Granatowa	Σκούρο μπλε	Тёмно-синий	Koyu mavi	Тъмносиньо	Tumesinine	Tumši zils	Tamsiai mélyna	Albastru închis	Temno modra	Tmavomodrá
DG	Sötétzöld	Ciemnozielona	Σκούρο πράσινο	Тёмно-зелёный	Koyu yesil	Тъмnozeleno	Tumeroheline	Tumši zaļš	Tamsiai žalia	Verde închis	Temno zelena	Tmavozelená
G	Zöld	Zielona	Πράσινο	Зелёный	Yeşil	Зелено	Roheline	Zaļš	Žalia	Verde	Zelena	Zelená
GR	Szürke	Szara	Γκρι	Серый	Gri	Сиво	Hall	Pelēks	Pilka	Gri	Siva	Sivá
LA	Levendulakék	Lawenda	Λεβάντα	Лавандовый	Lavanta	Лавандула	Lavendel	Lavanda	Lavanda	Lavandă	Sivka	Levandul'a
LB	Világoskék	Jasniebieska	Ανοικτό μπλε	Голубой	Acik mavi	Светлосиньо	Helesinine	Gaiši zils	Šviesiai mélyna	Albastru deschis	Svetlo modra	Svetlomodrá
LG	Világoszöld	Jasnozielona	Ανοικτό πράσινο	Светло-зелёный	Acik yesil	Светлозелено	Heleroheline	Gaiši zaļš	Šviesiai žalia	Verde deschis	Svetlo zelena	Svetlozelená
NO	Természetes színű	Barwy naturalne	Φυσικά χρώματα	Телесный	Nötr	Естествен цвят	Värvitu	Dabiska krāsa	Natūrali spalva	Culoare naturală	Naravna barva	Přírodní farba
O	Narancs	Pomarańczowa	Πορτοκαλί	Оранжевый	Turuncu	Оранжево	Oranž	Oranžs	Oranžine	Portocaliu	Oranžna	Oranžová
P	Rózsaszín	Różowa	Ροζ	Розовый	Pembe	Розово	Roosa	Rozā	Rožinē	Roz	Roza	Růžová
R	Piros	Czerwona	Κόκκινο	Красный	Kırmızı	Червено	Punane	Sarkans	Raudona	Roșu	Rdeča	Červená
PU	Bíborvörös	Purpurowa	Πορφύρο	Пурпурный	Mor	Пурпурно	Tumepunane	Purpursarkans	Purpurinē	Mov	Škrlatna	Purpurová
SB	Égszínkék	Bękitna	Γαλάζιο	Небесно-голубой	Gök mavisi	Небесносиньо	Taevasinine	Debeszils	Žydra	Azuriu	Nebesno modra	Azürová
T	Sárgásbarna	Żółto-brązowa	Κίτρινοκαφέ	Жёлто-коричневый	Sari kahverengi	Жълтокафяво	Kollanepruun	Dzeltenbrūns	Gelsvai ruda	Galben-marro	Rumeno rjava	Žltohnědá
W	Fehér	Biała	Λευκό	Белый	Beviz	Бяло	Valge	Balts	Balta	Alb	Bela	Biela
Y	Sárga	Żółta	Κίτρινο	Жёлтый	Sarı	Жълто	Kollane	Dzeltens	Geltona	Galben	Rumena	Žltá
V	Ibolyakék	Fioletowa	Μοβν	Фиолетовый	Menekşe	Виолетово	Lilla	Violetis	Violetinē	Violet	Vijolična	Fialová

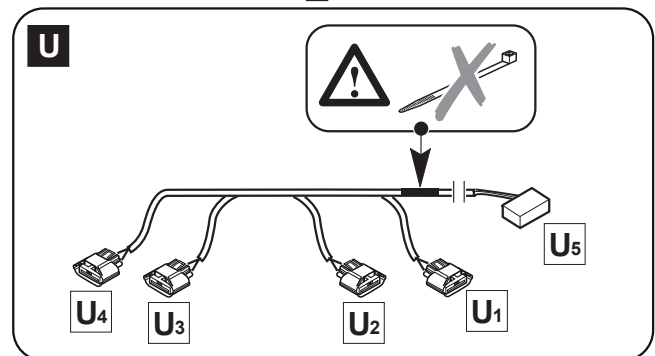
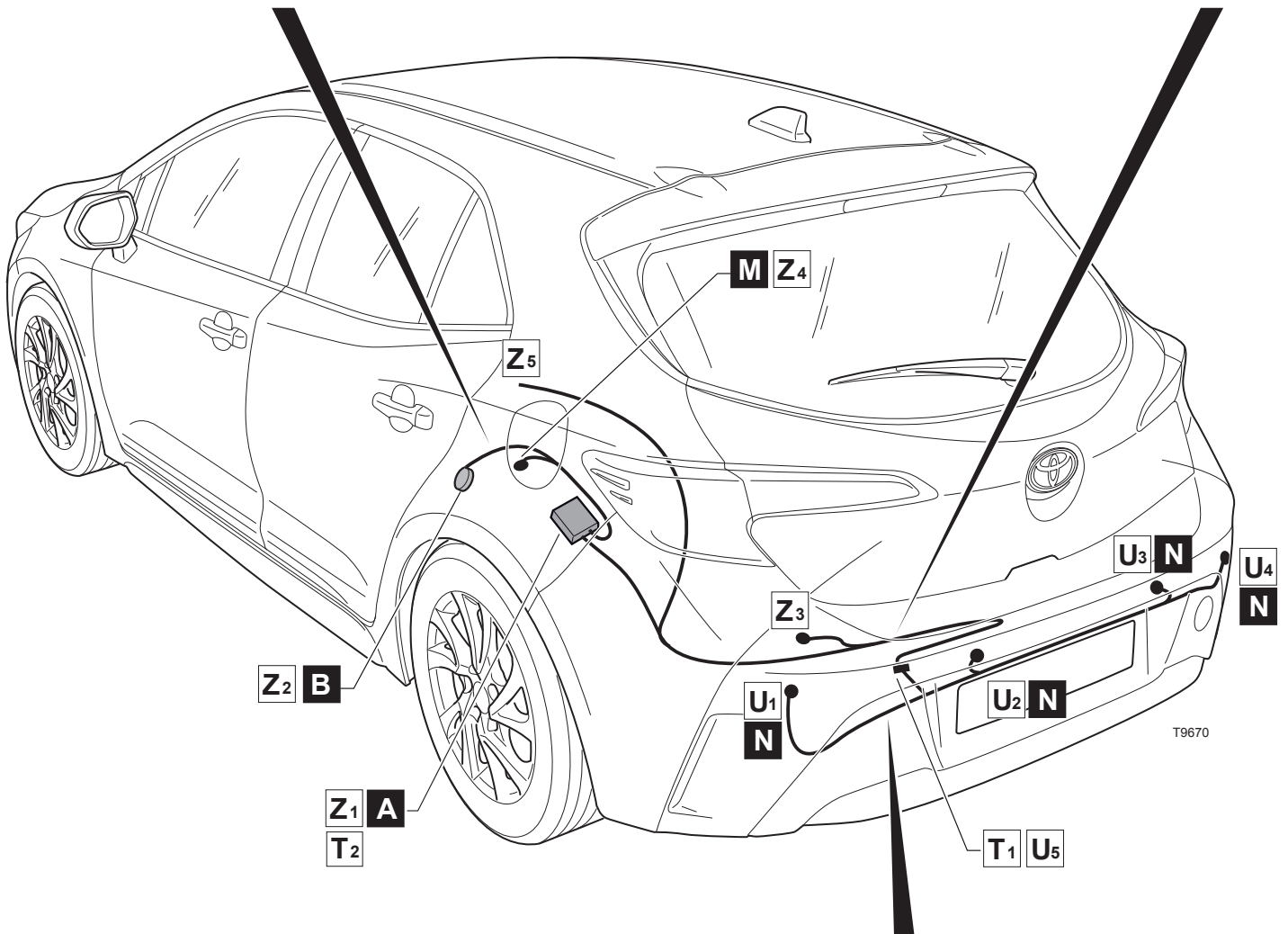
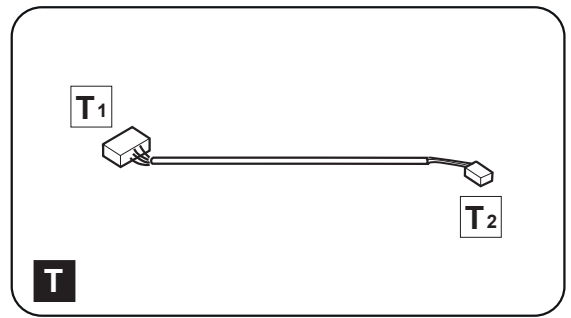
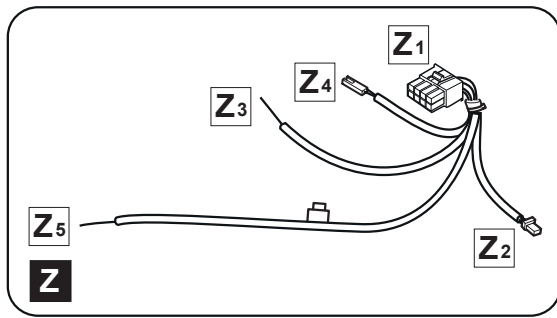

= XX mm	=	=
= XX mm	=	=
=	=	=
= TXX	=	★ = START

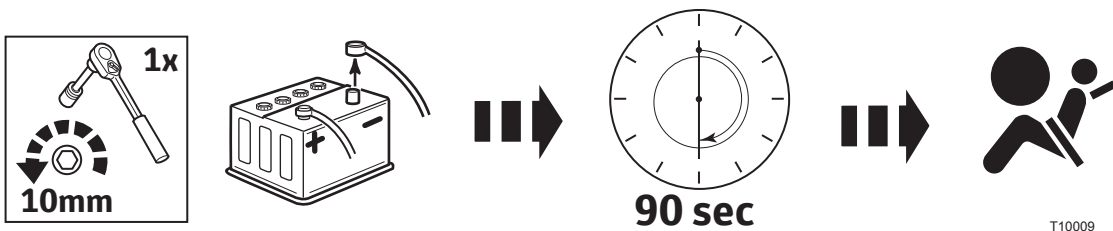
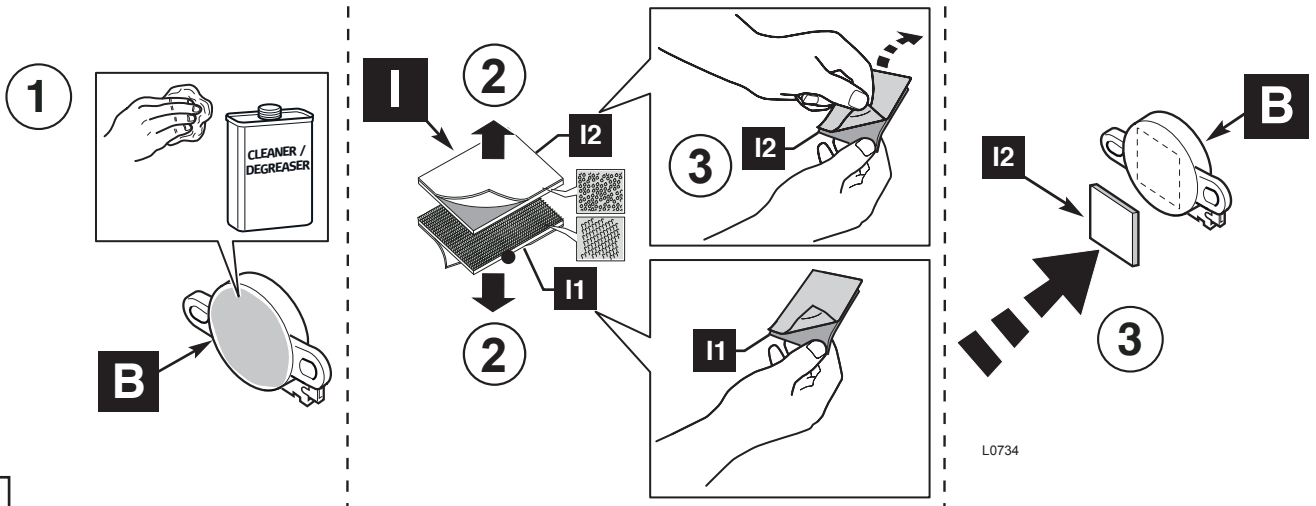
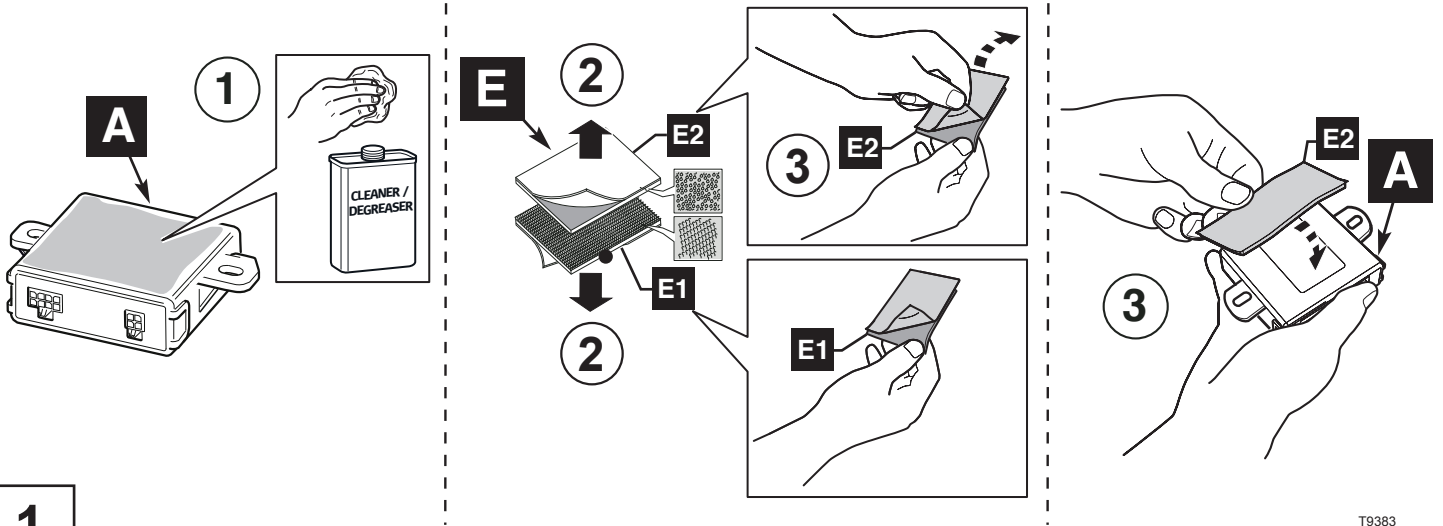

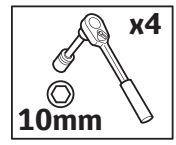
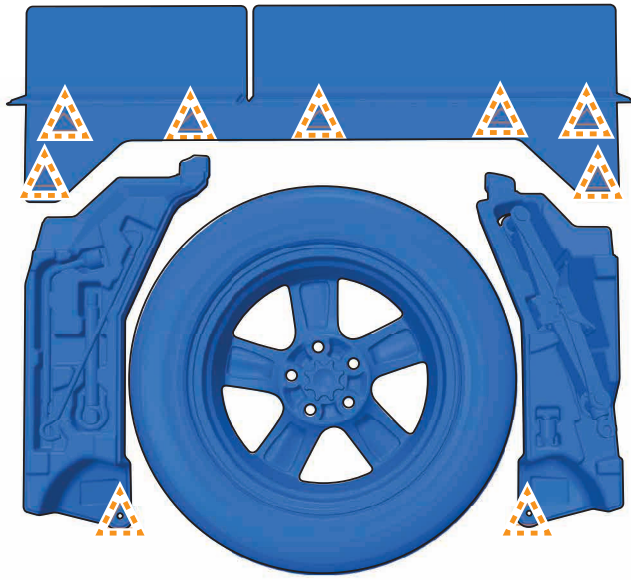

1

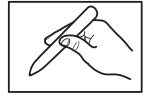

3

1



6

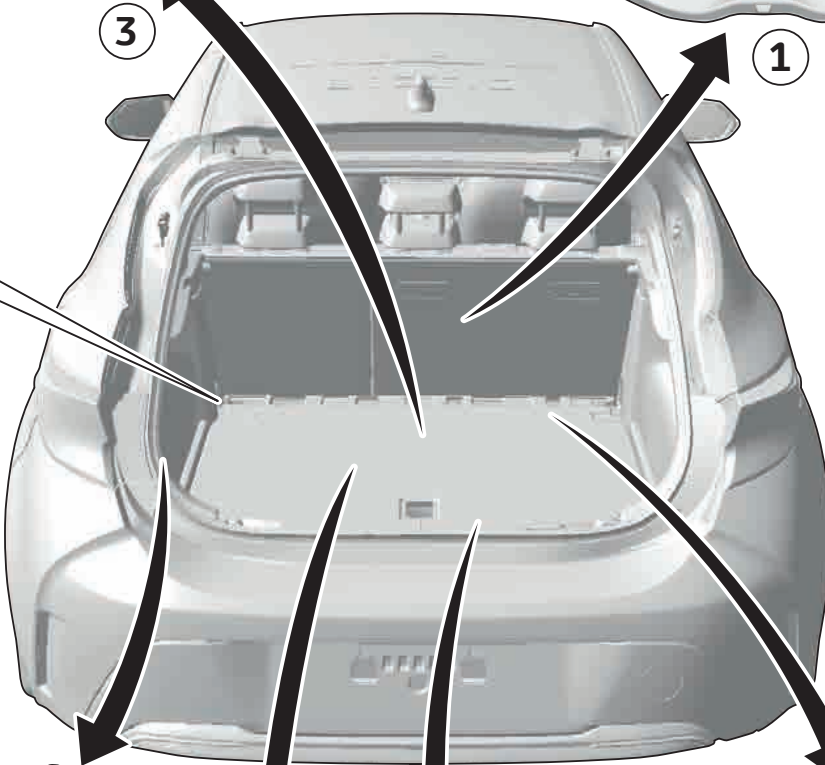
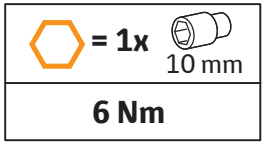

T9756

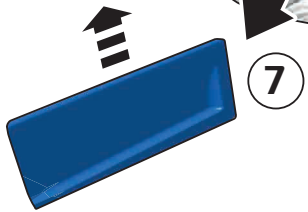

7

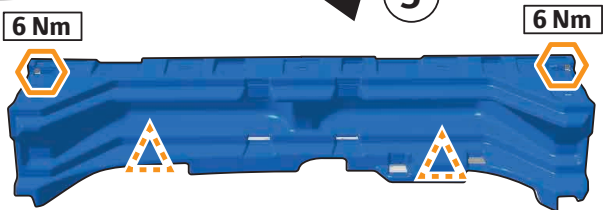

6 Nm

6 Nm



6 Nm

6 Nm

2

4

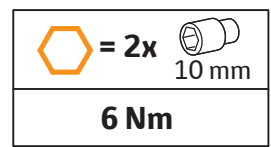

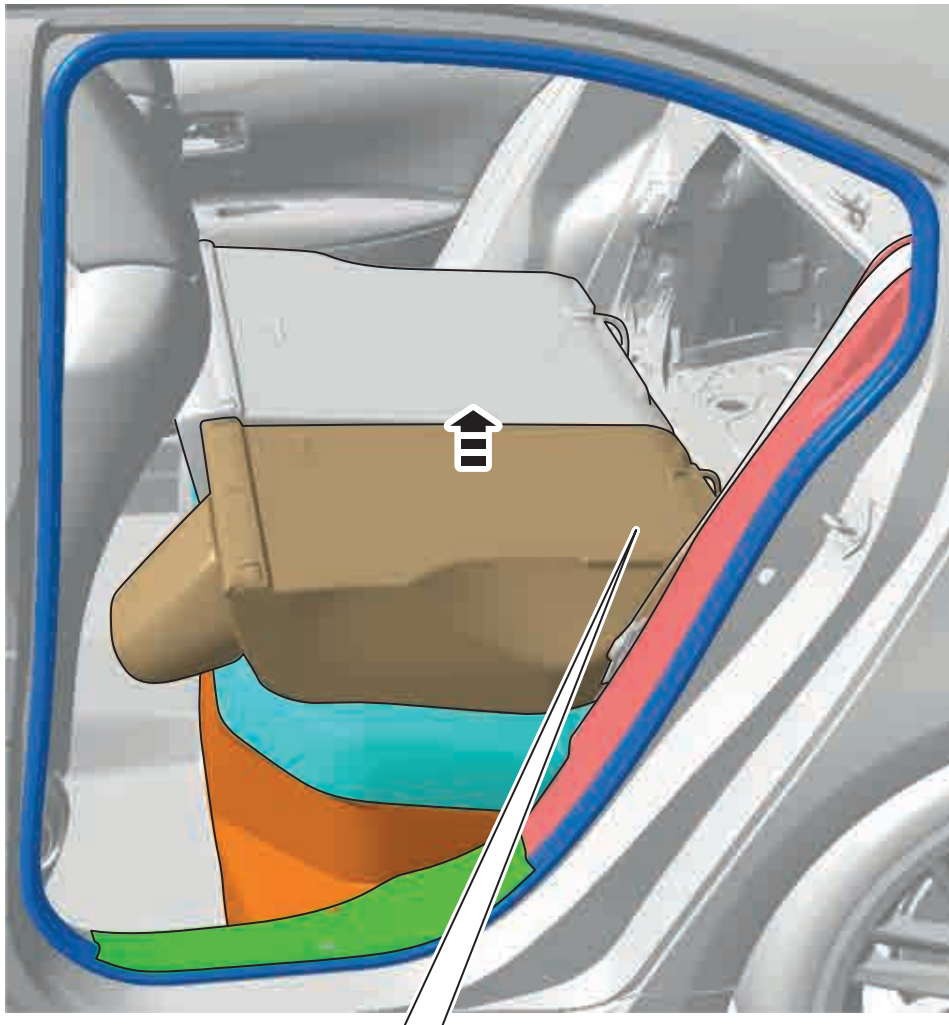

4

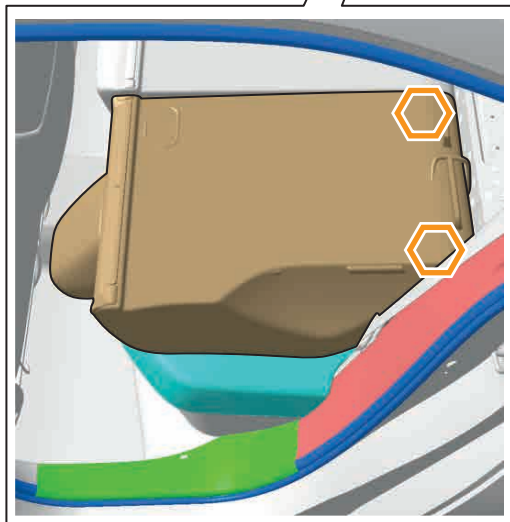

T9757



 = 2x  14 mm

37 Nm



5



18 Nm

⬡ = 1x  12 mm



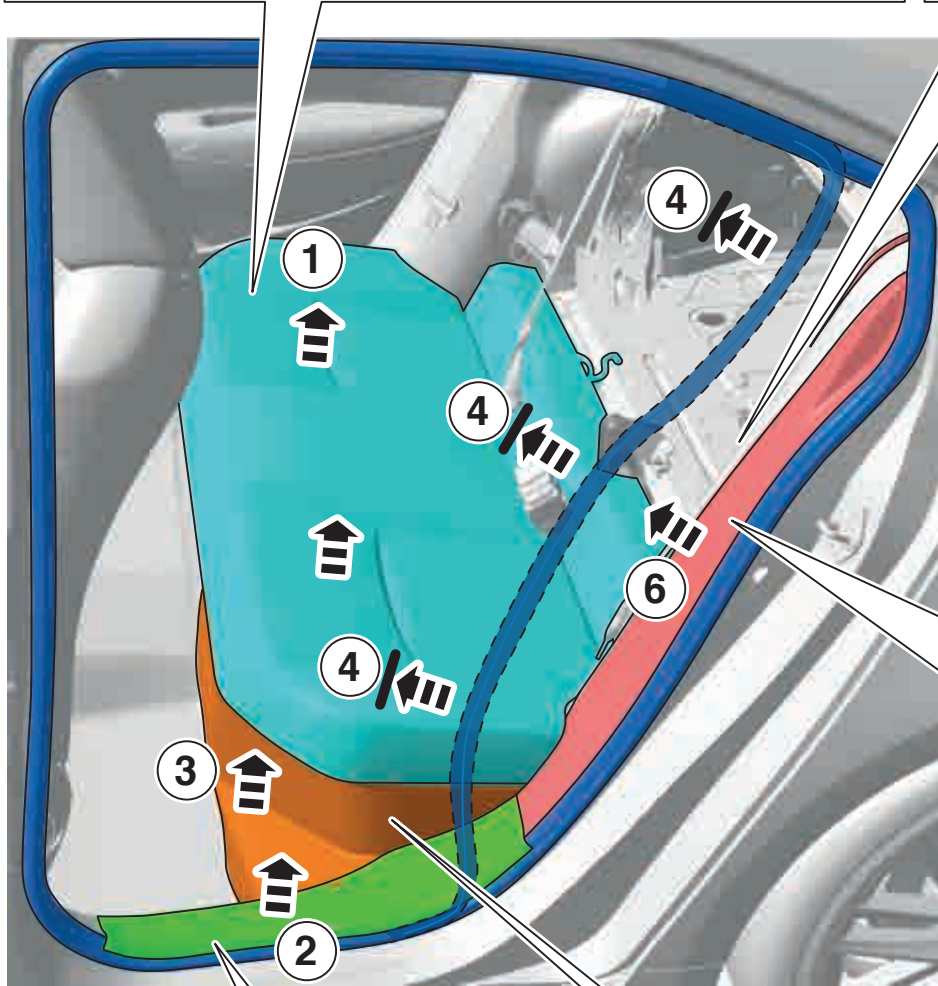
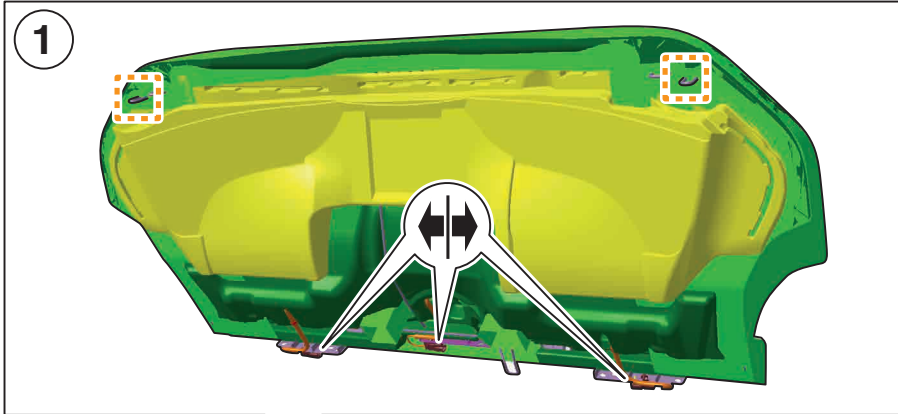



⬡ = 2x 

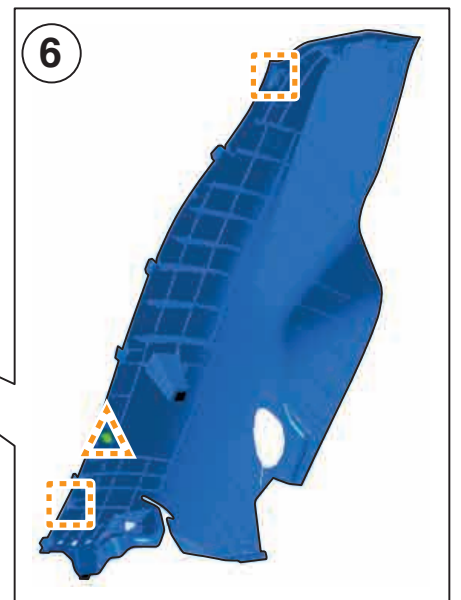

⬡ = 1x  ⬡ = 2x 





⬡ = 7x 

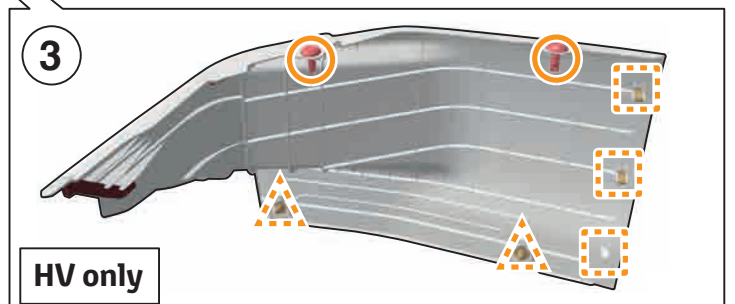
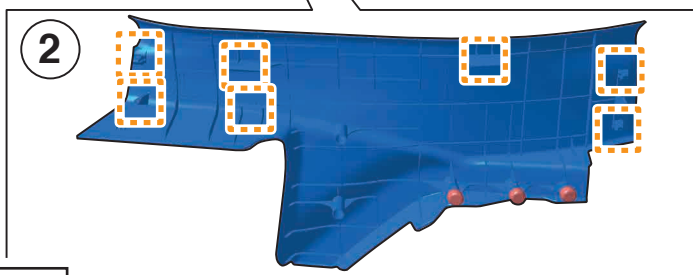





⬡ = 2x  ⬡ = 3x  ○ = 2x 

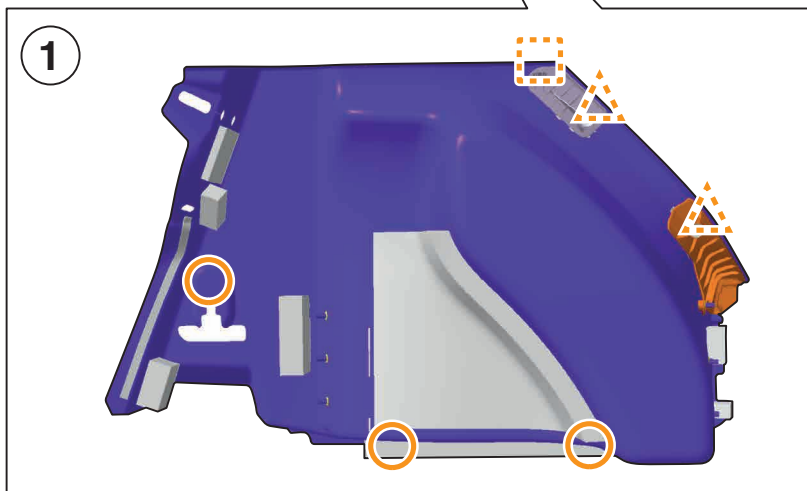
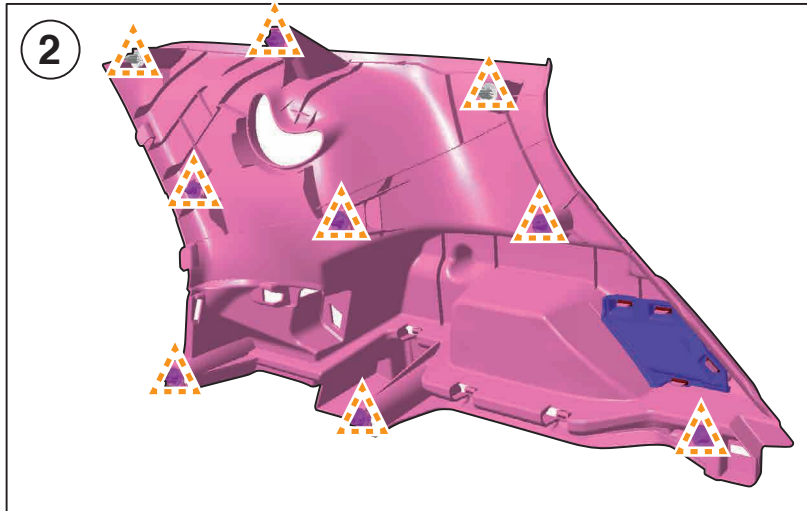

6

 = 9x 



 = 2x   = 1x   = 3x 

7

○ = 10x 

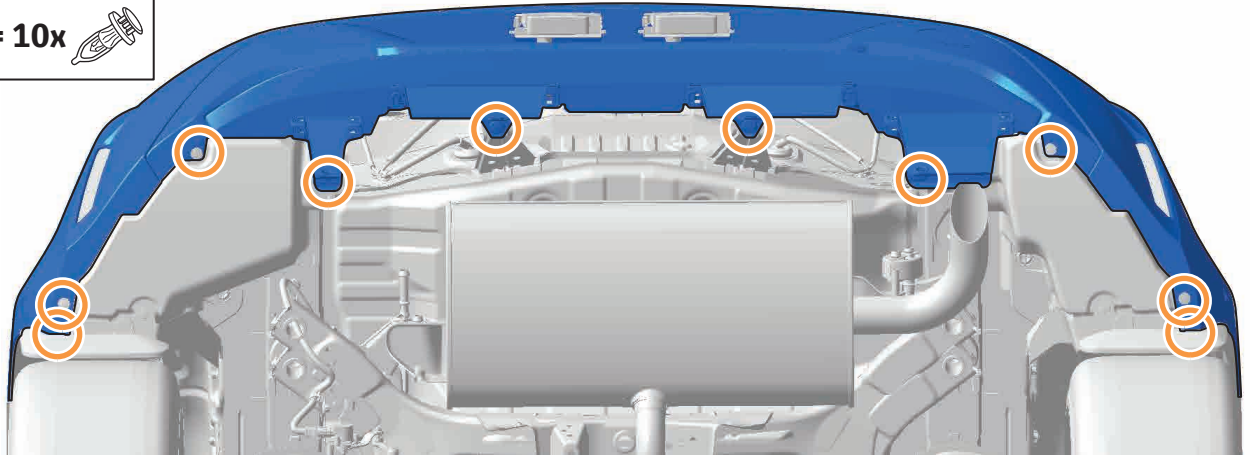

8

②
⬡ = 2x  10mm

LHS=RHS

①  = 7x

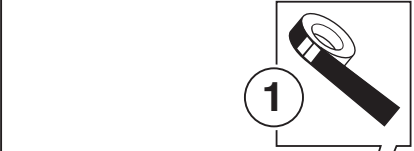
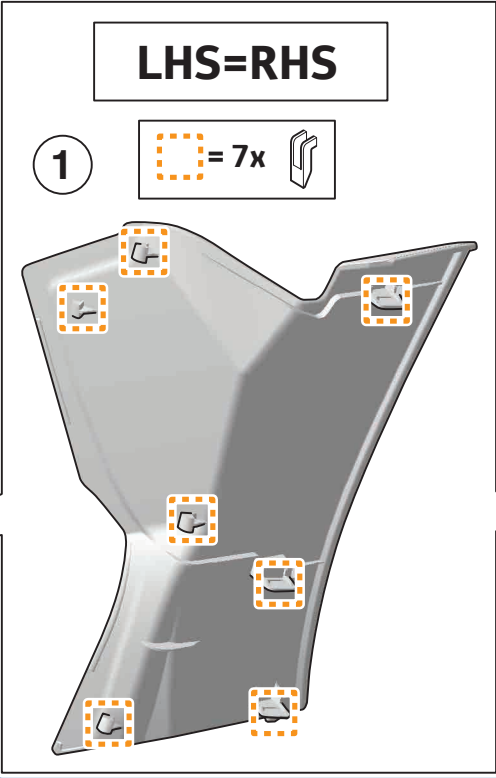
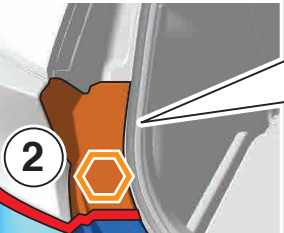

①

①



④

T9763

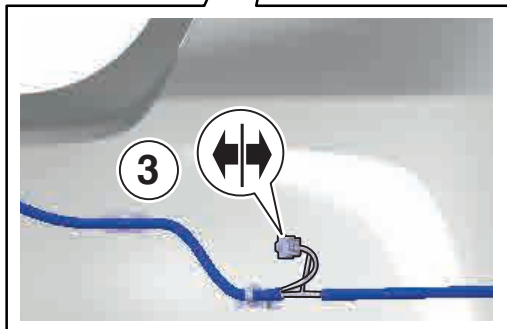

9

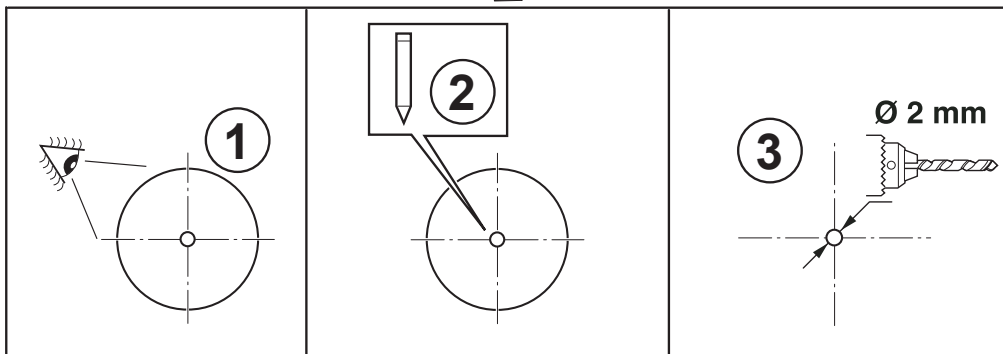
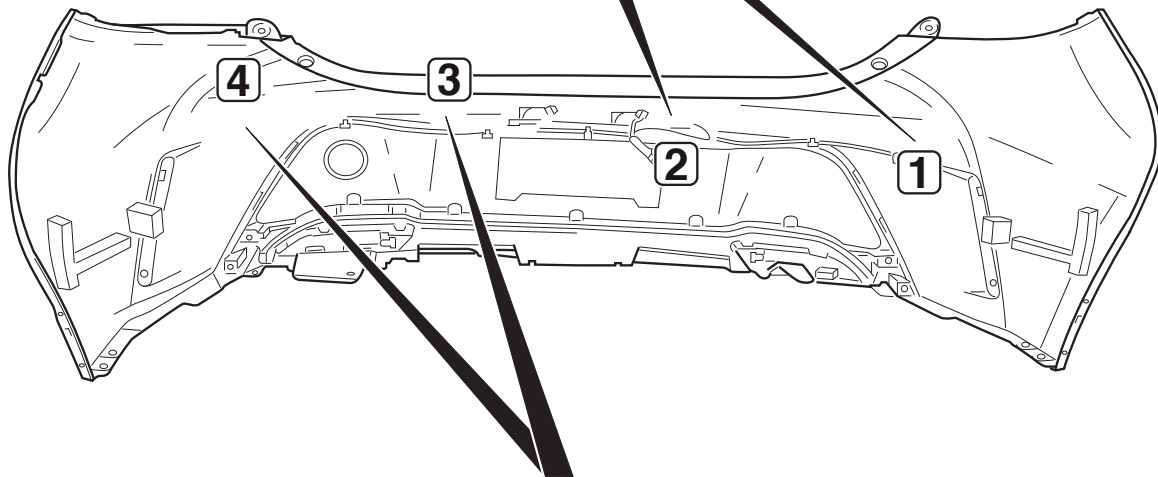
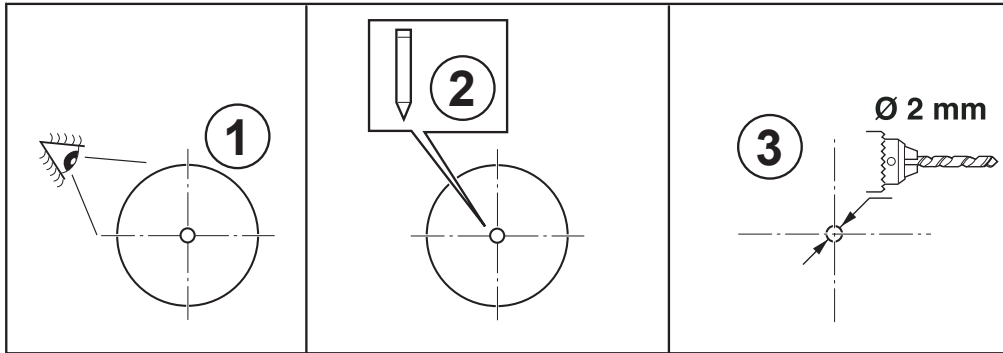

T9569

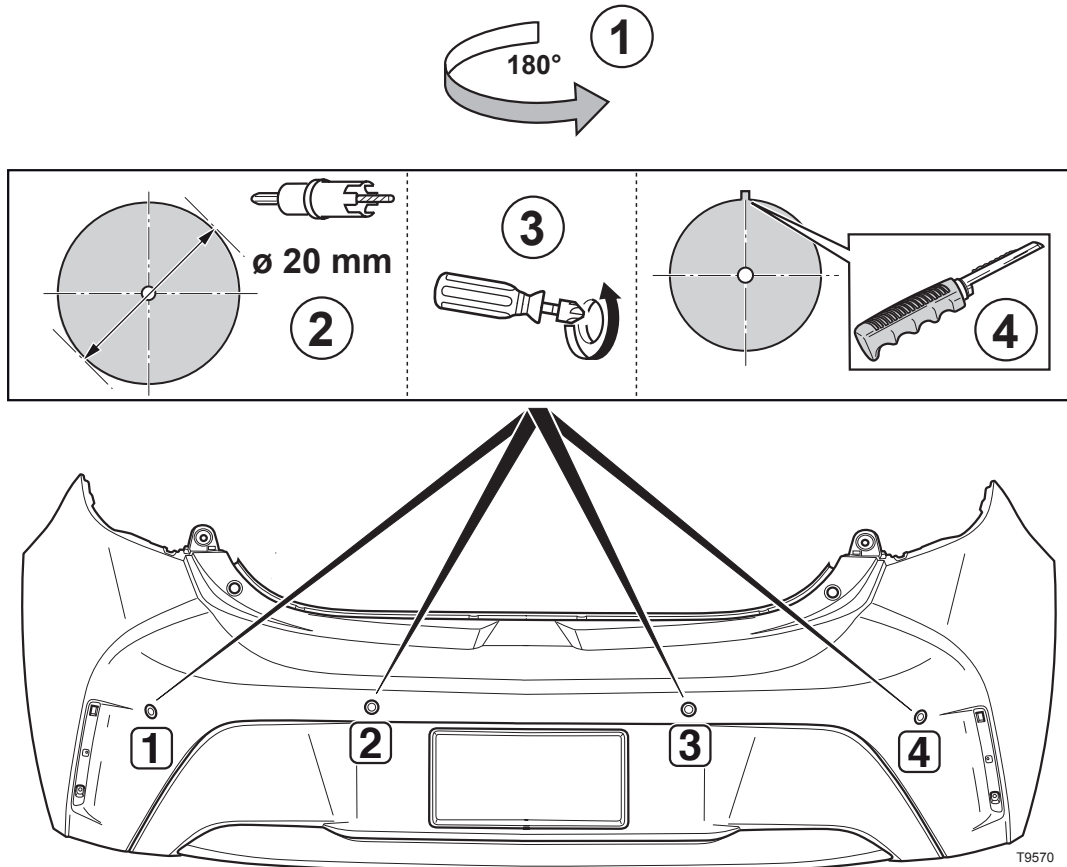

11

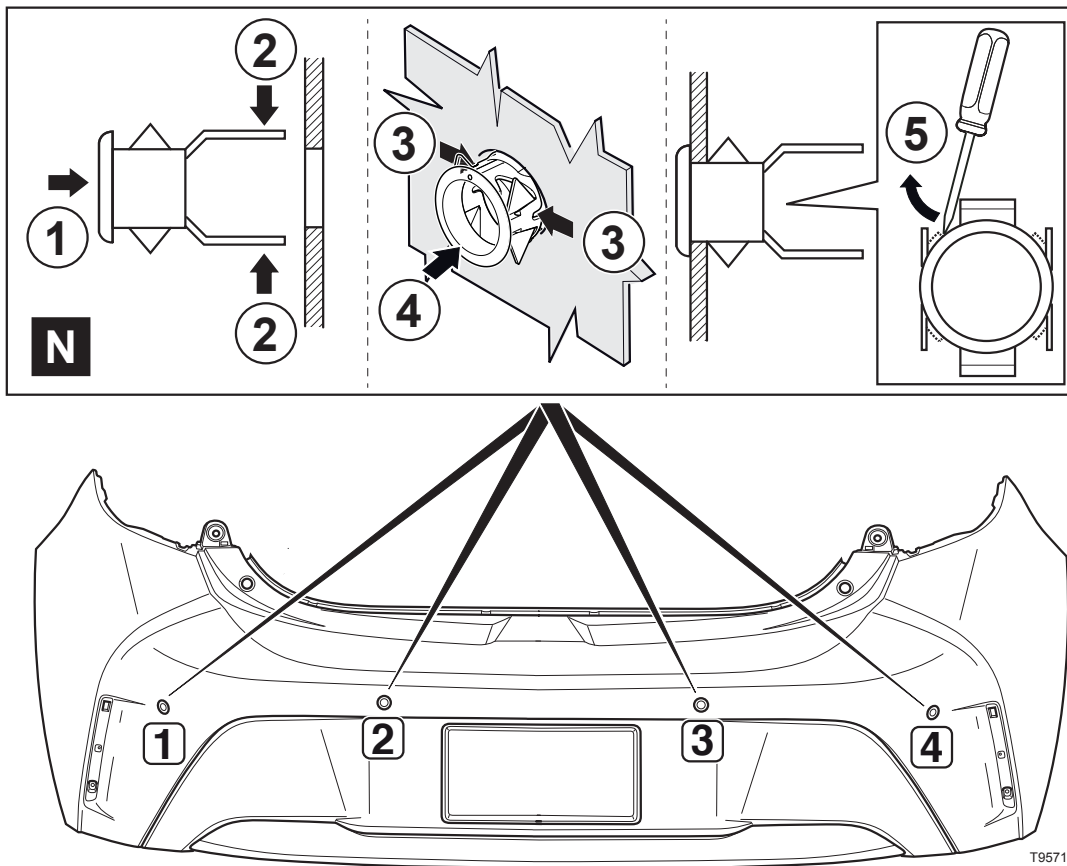

12

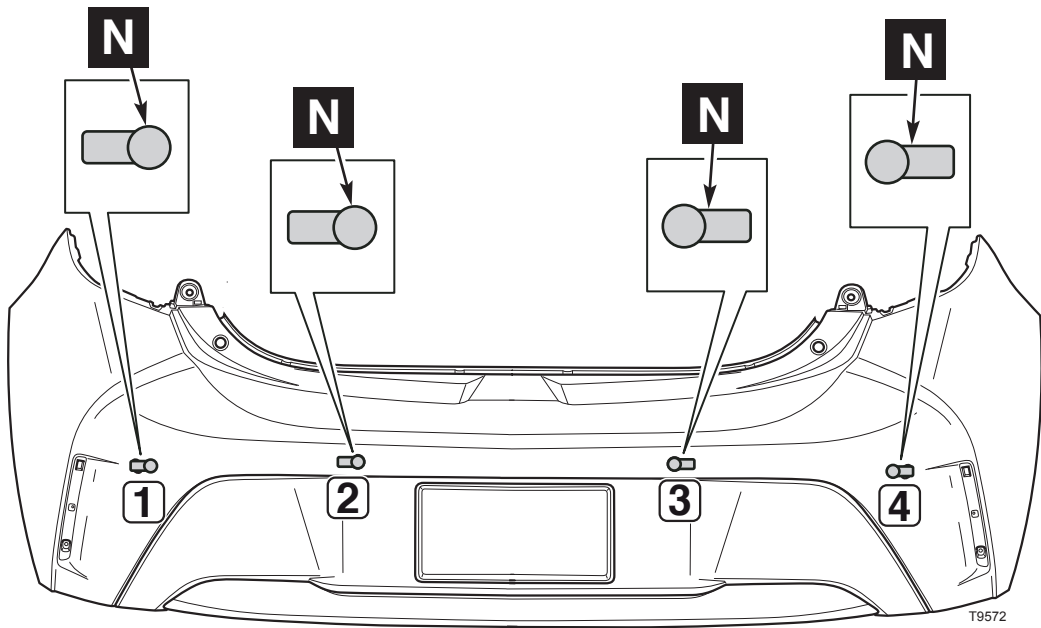
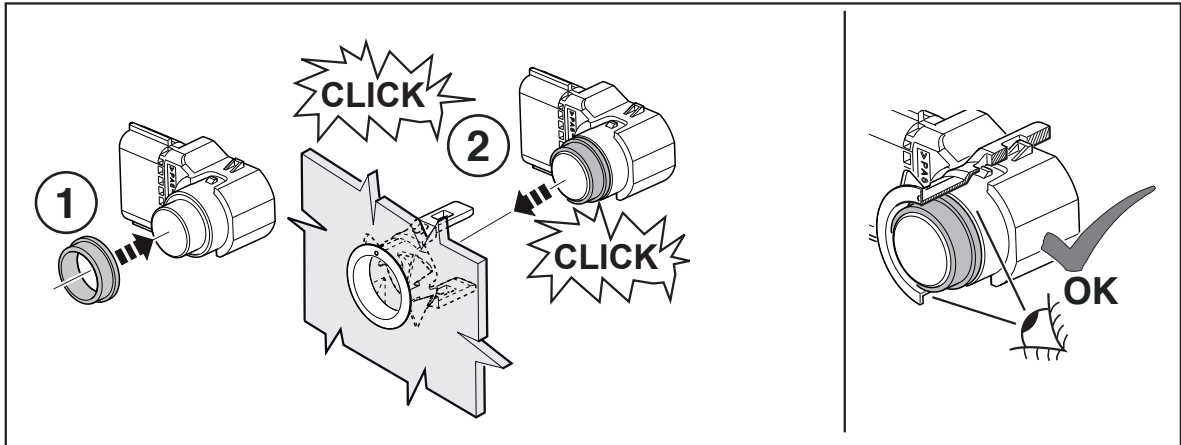

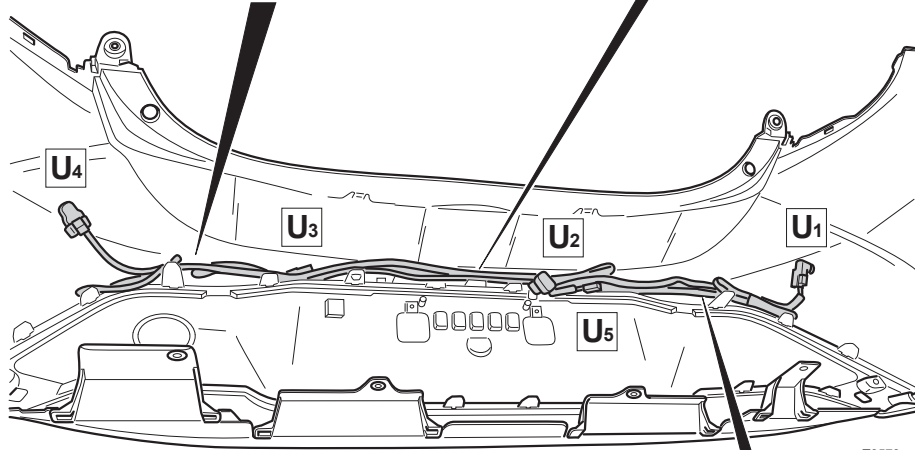
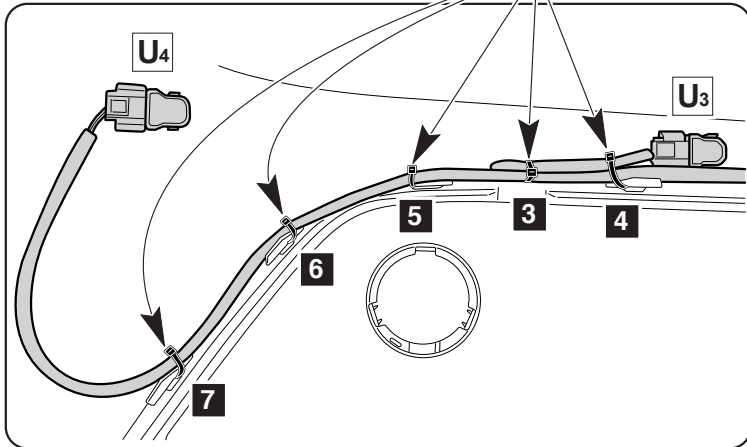
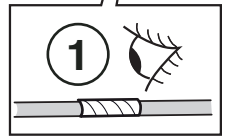
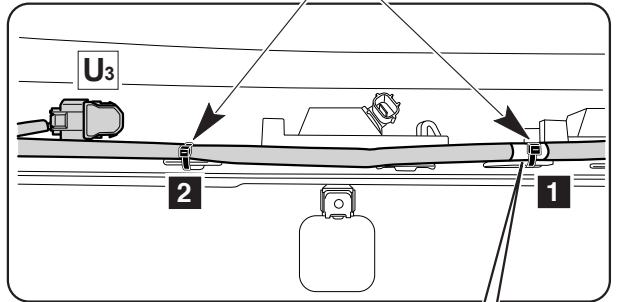
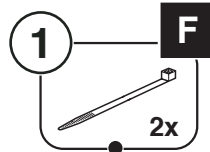
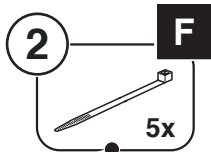
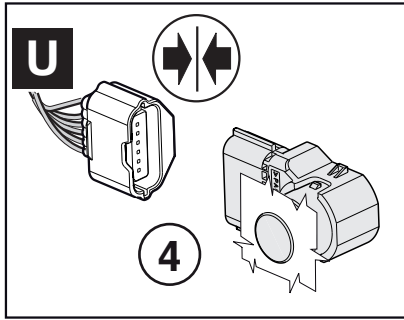

T9573

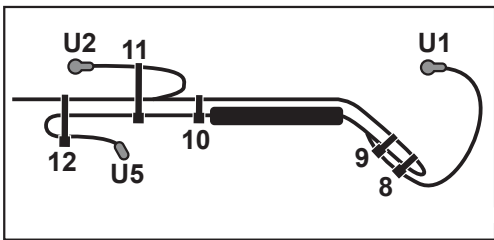
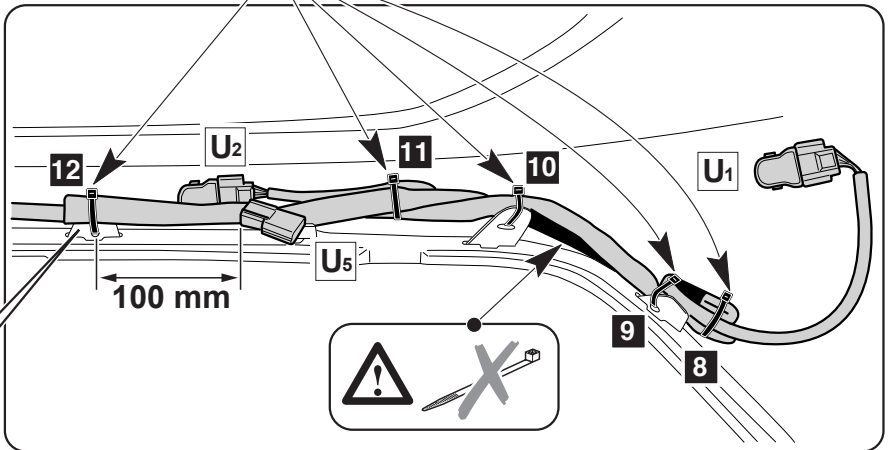
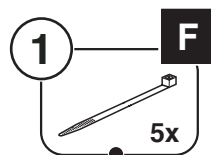

14

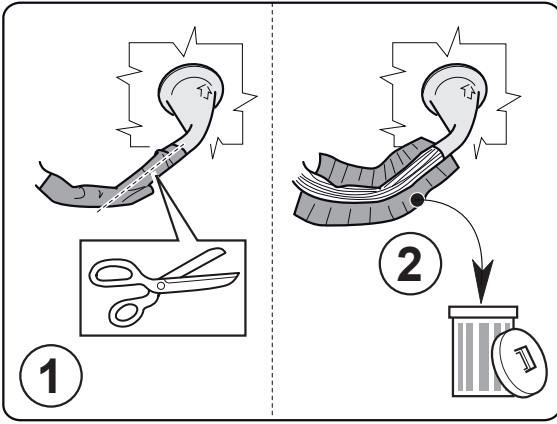

T9649

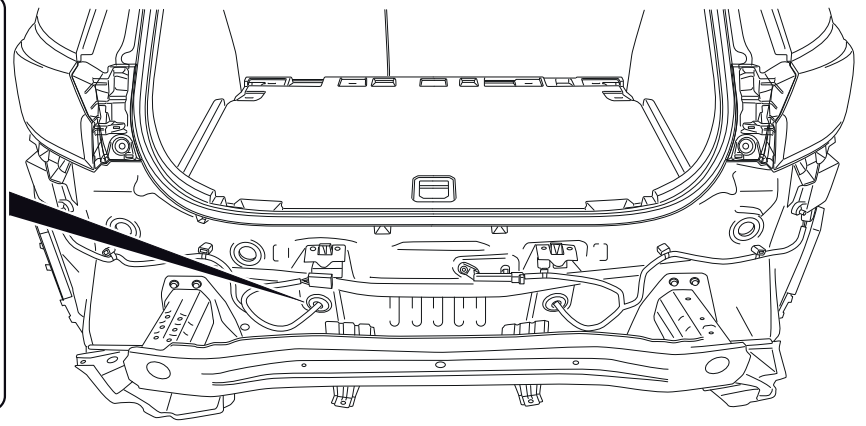

15

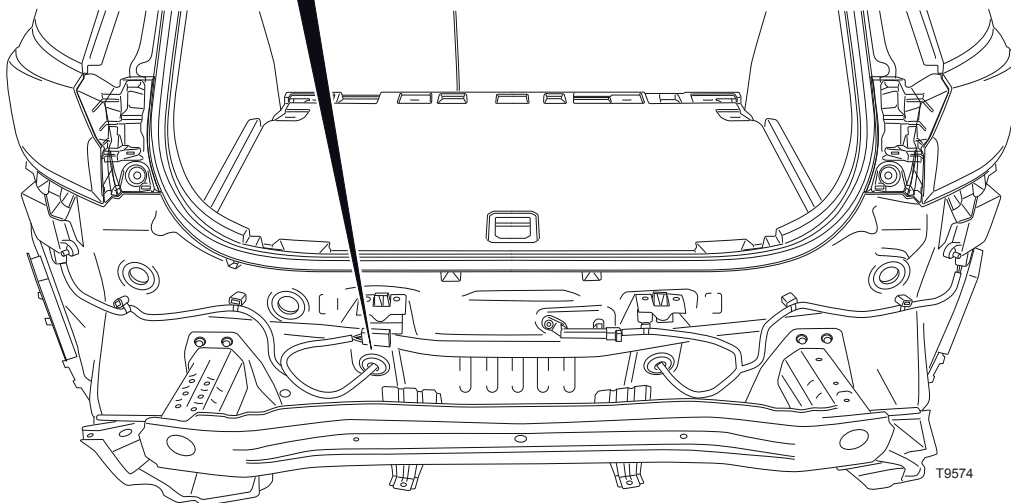
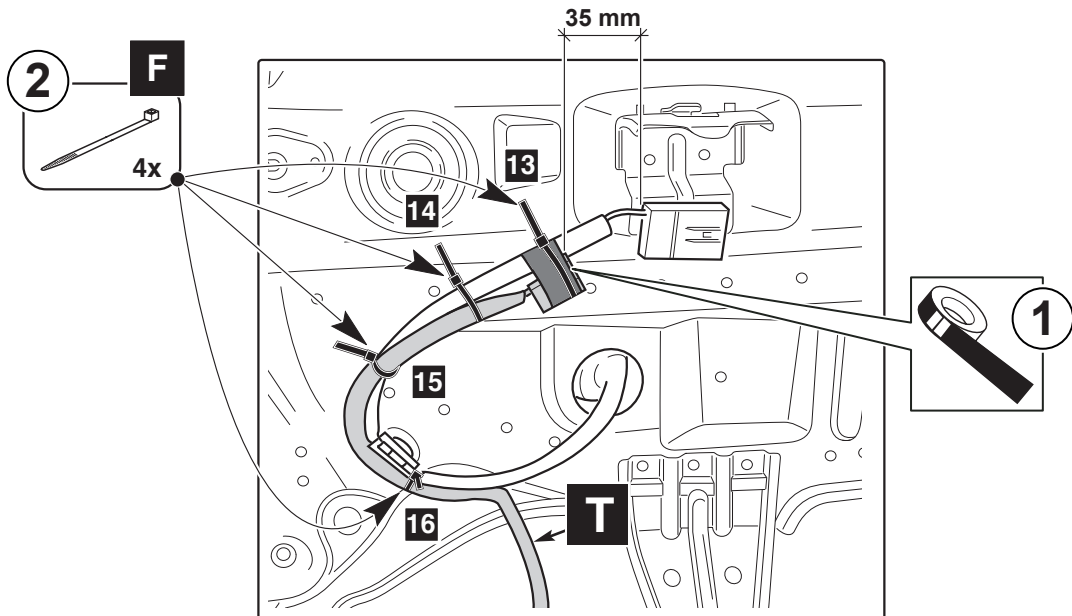

T9574

16

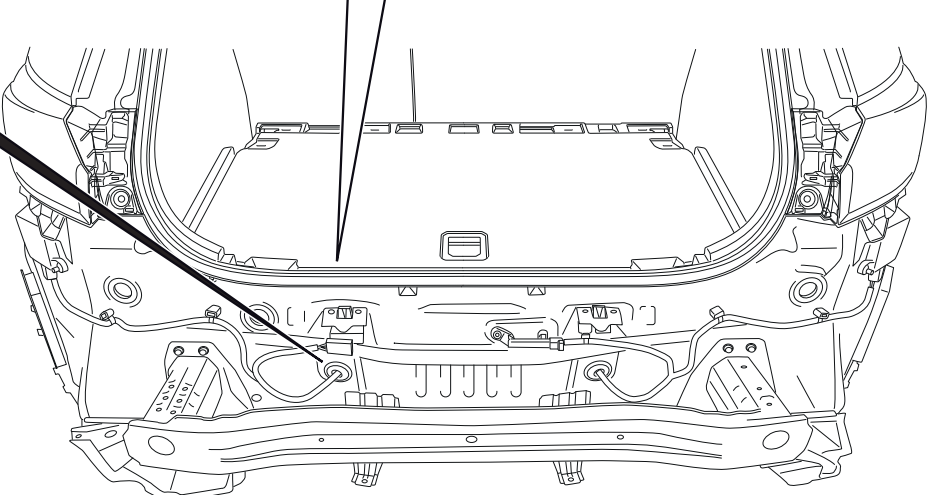
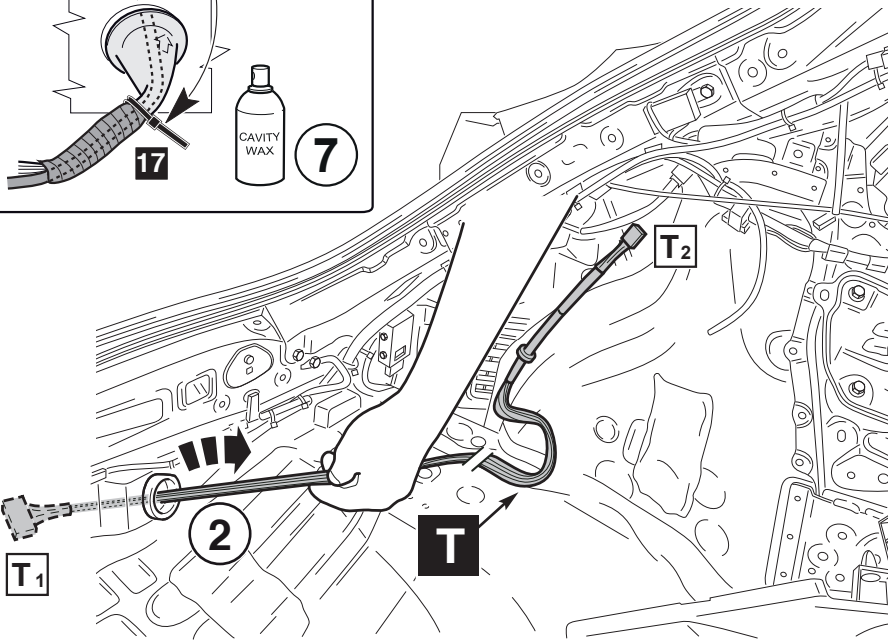
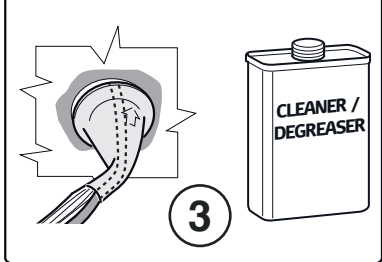
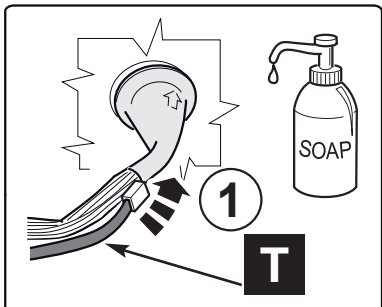
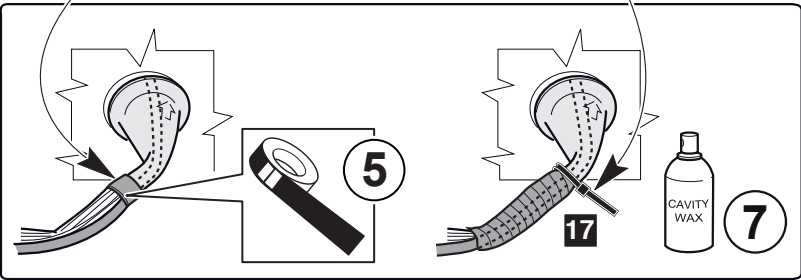
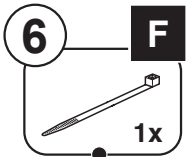
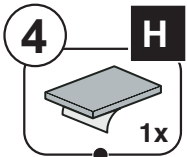

T9576

17

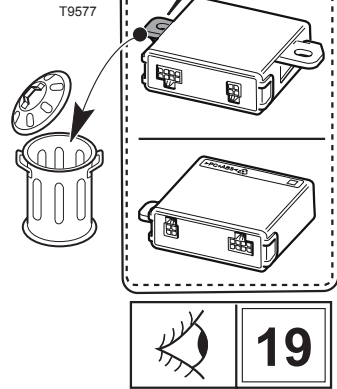
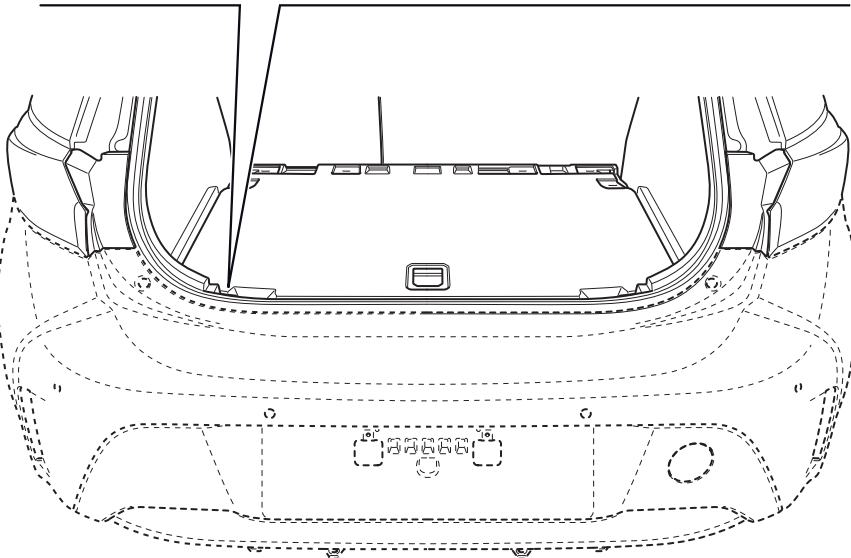
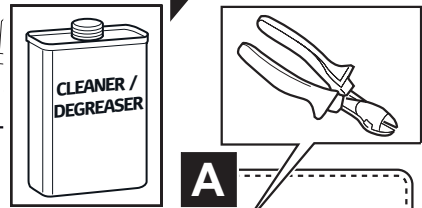
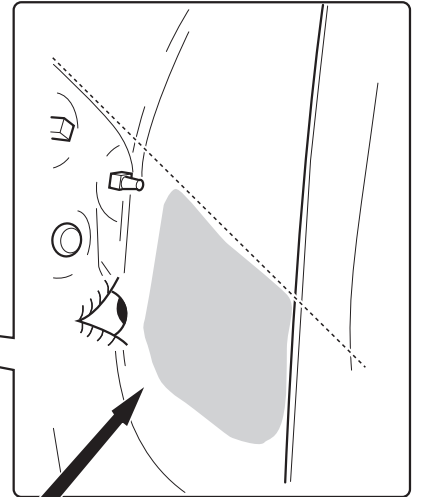
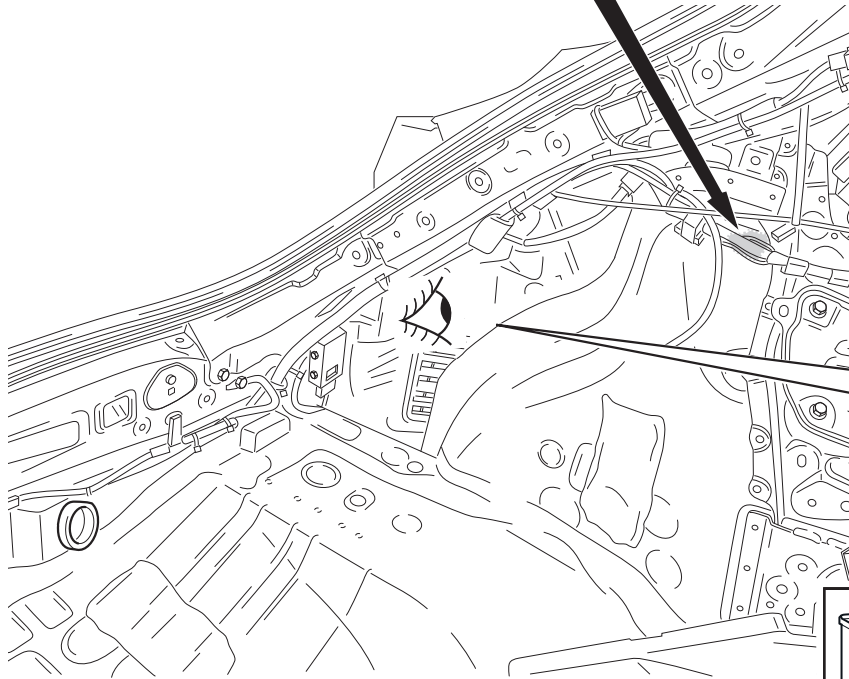
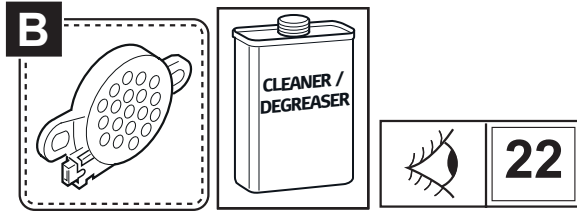

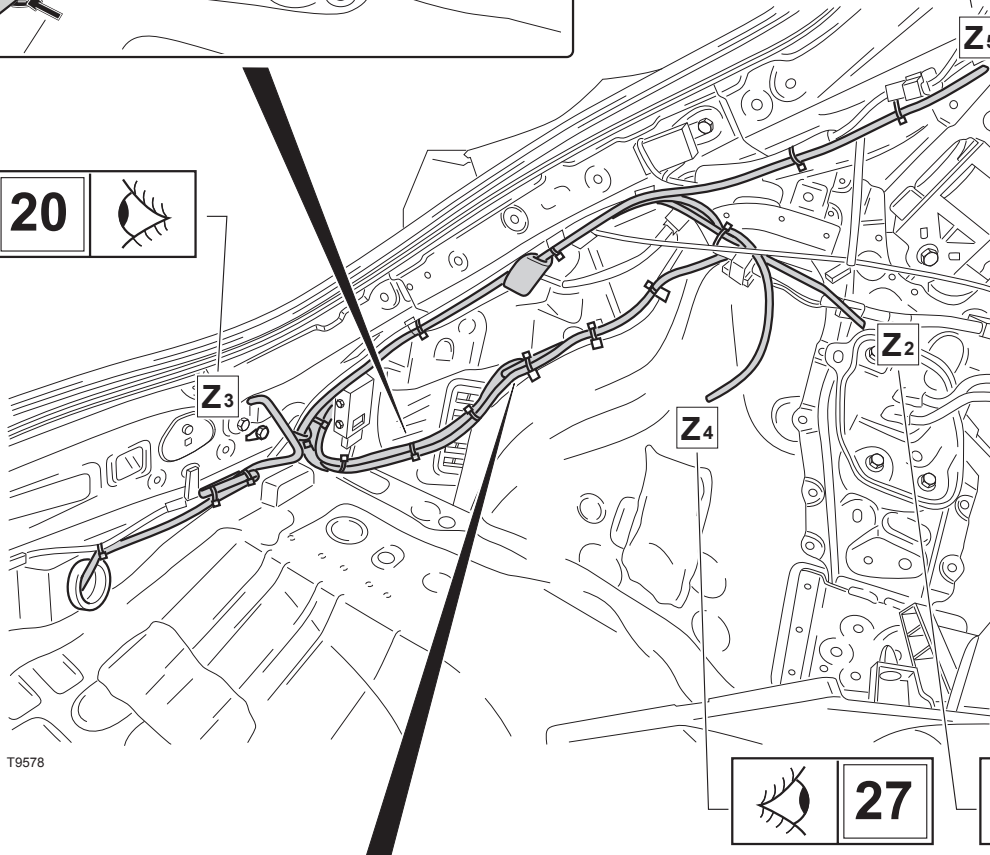
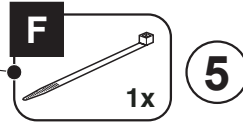
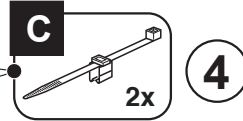
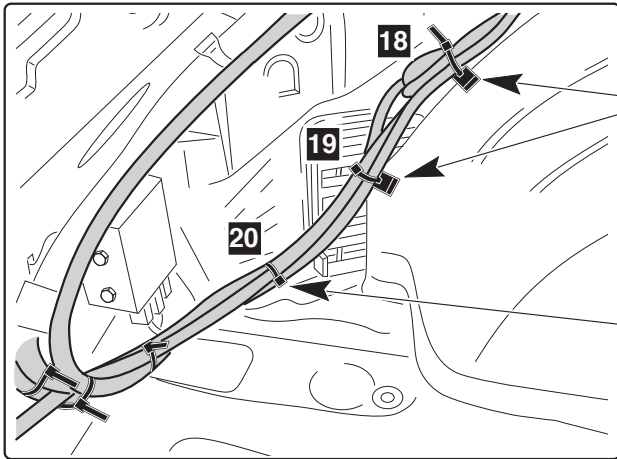

T9578

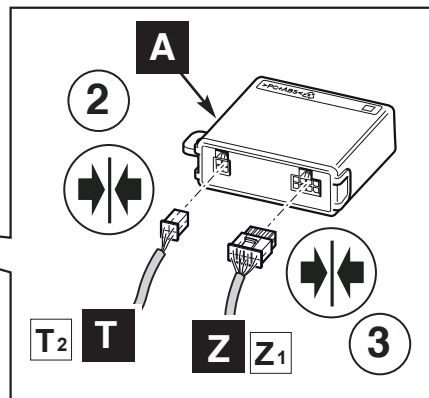
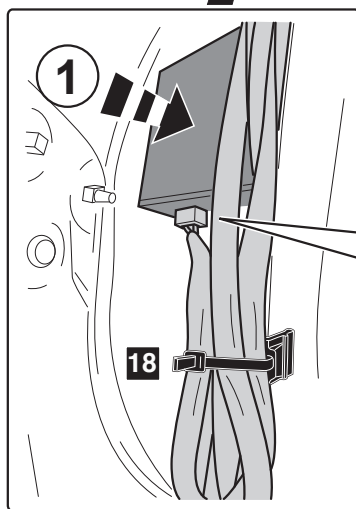

19

WITH FUEL PUMP CONTROL

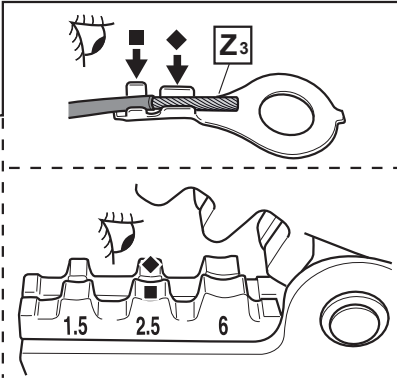
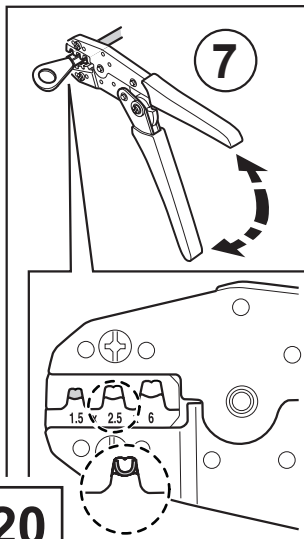
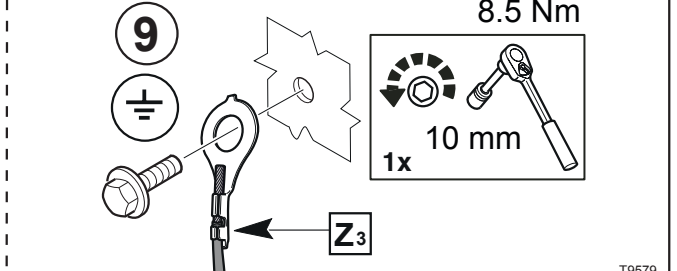
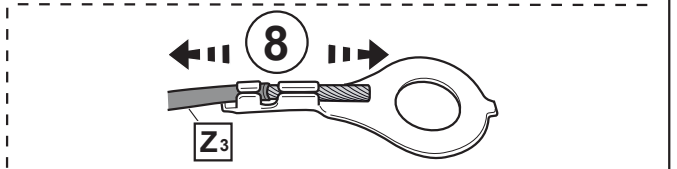
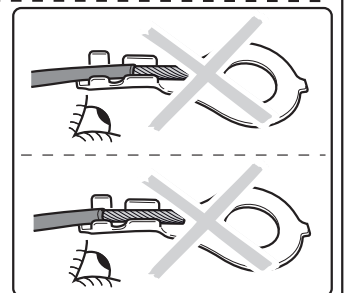
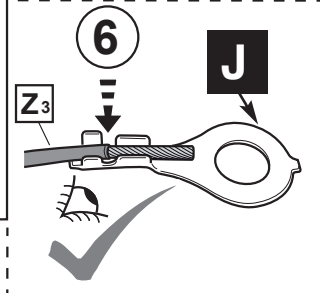
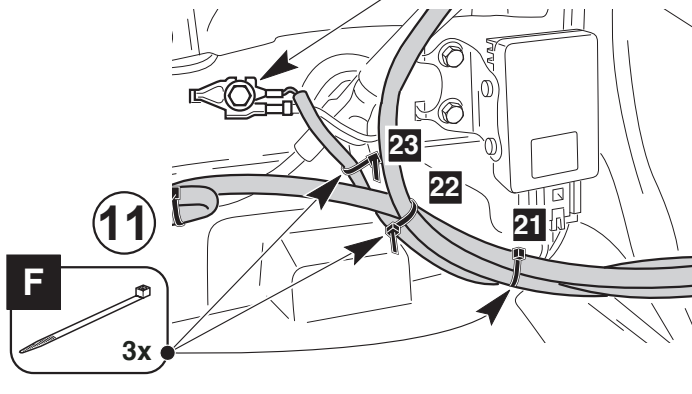
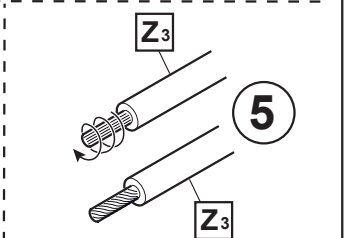
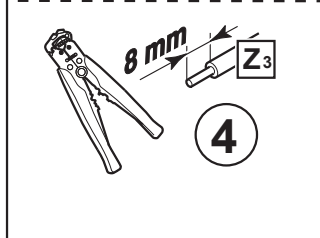
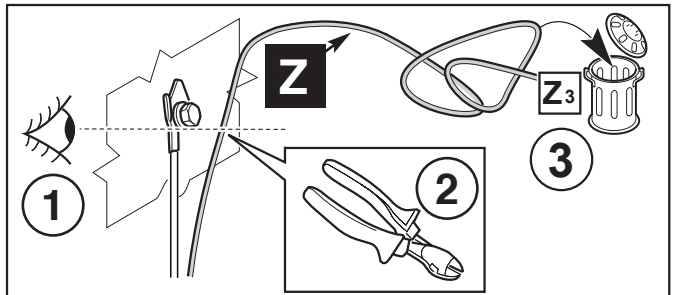
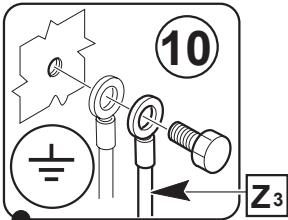
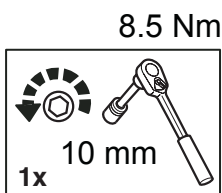
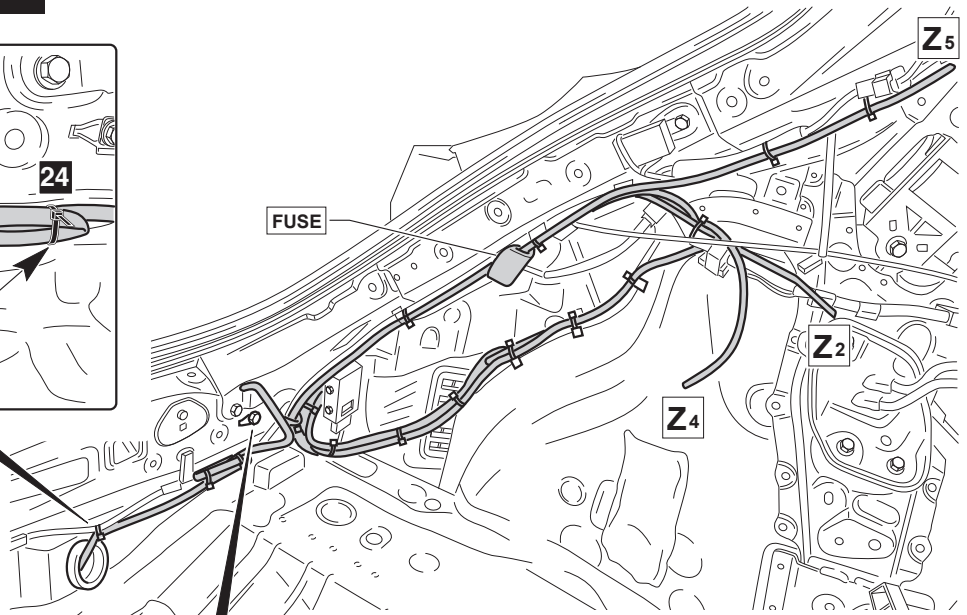
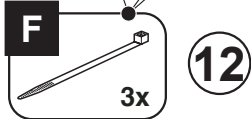
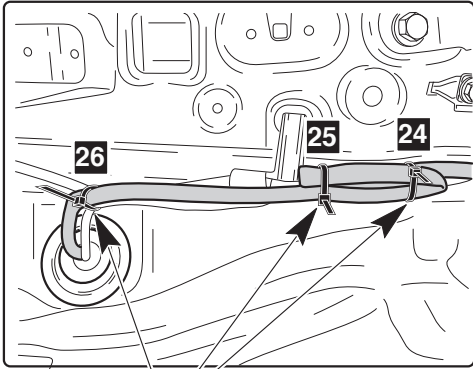

20

T9579

WITHOUT FUEL PUMP CONTROL

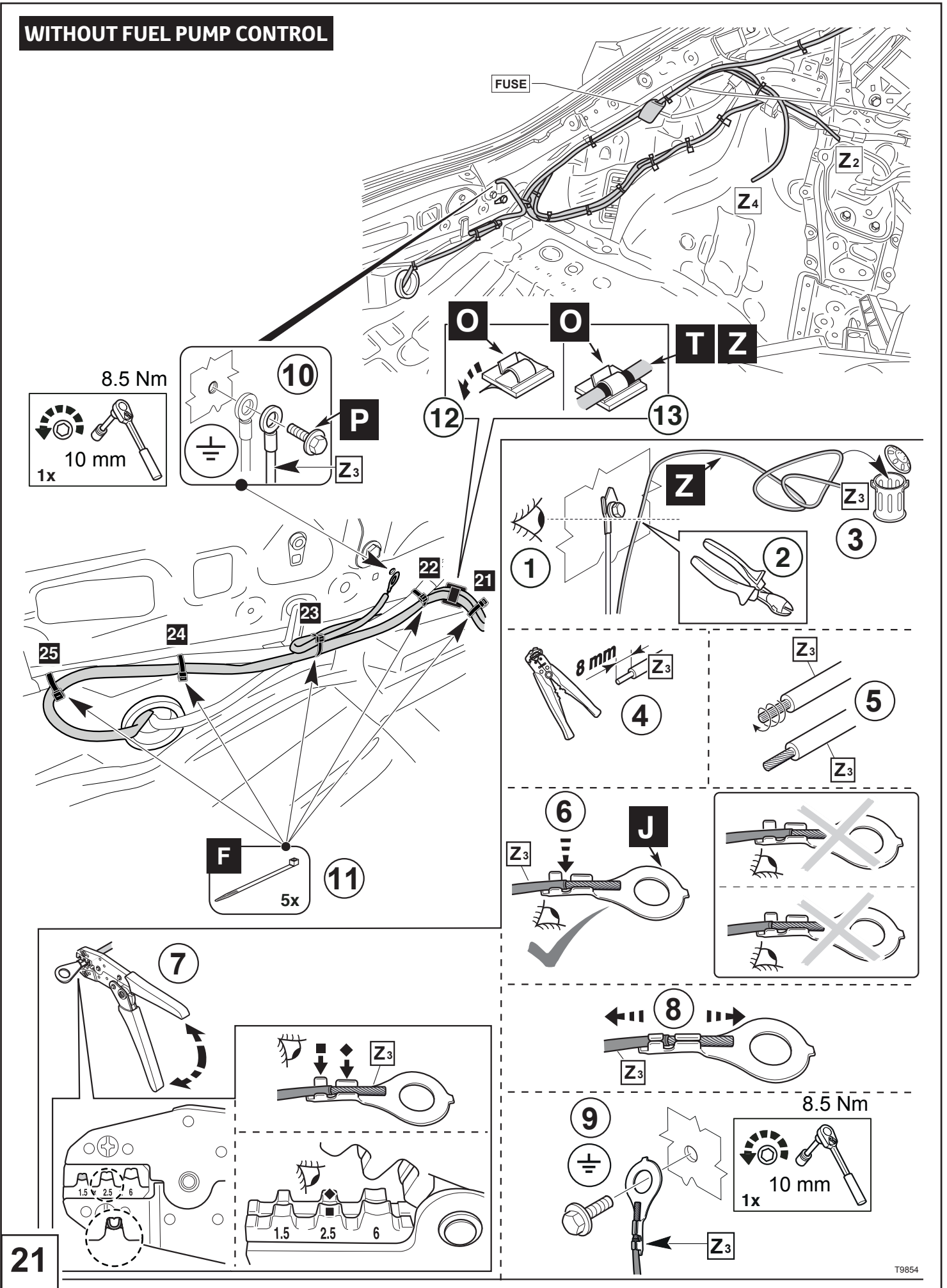

T9854

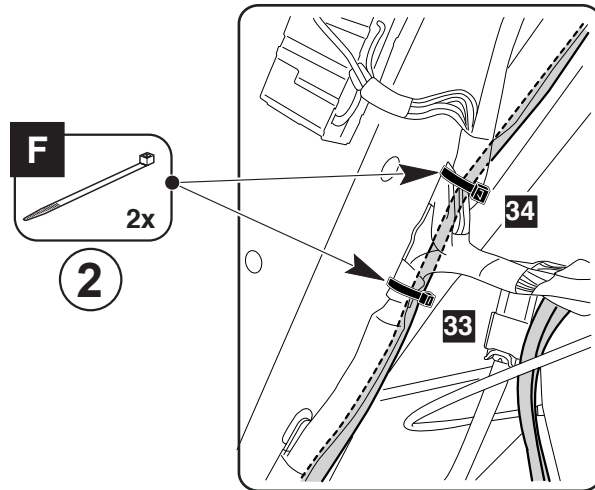
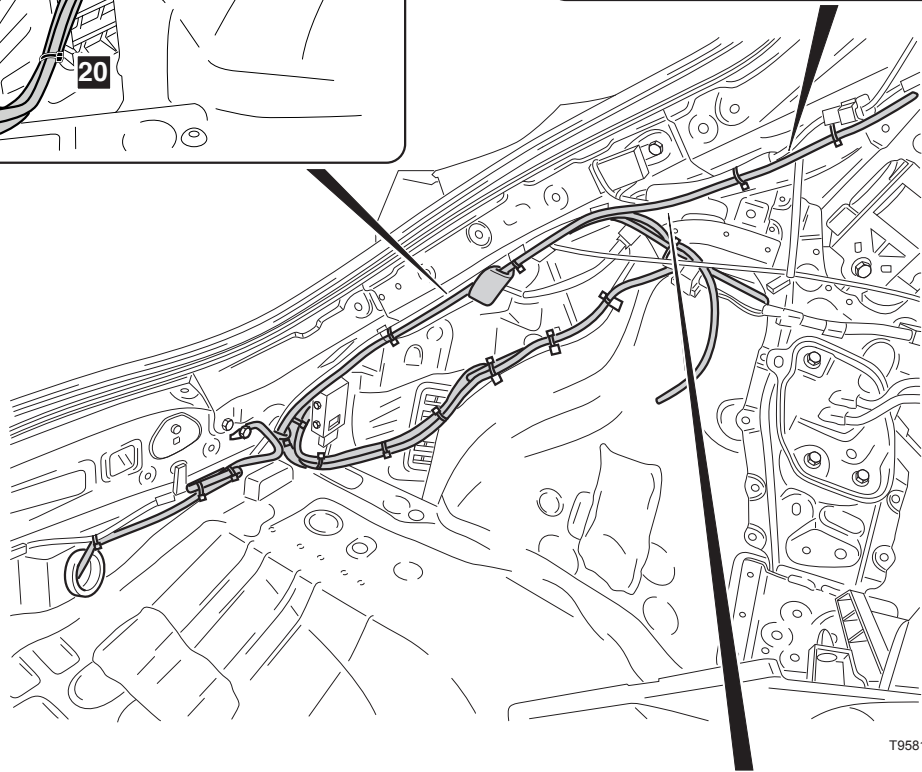
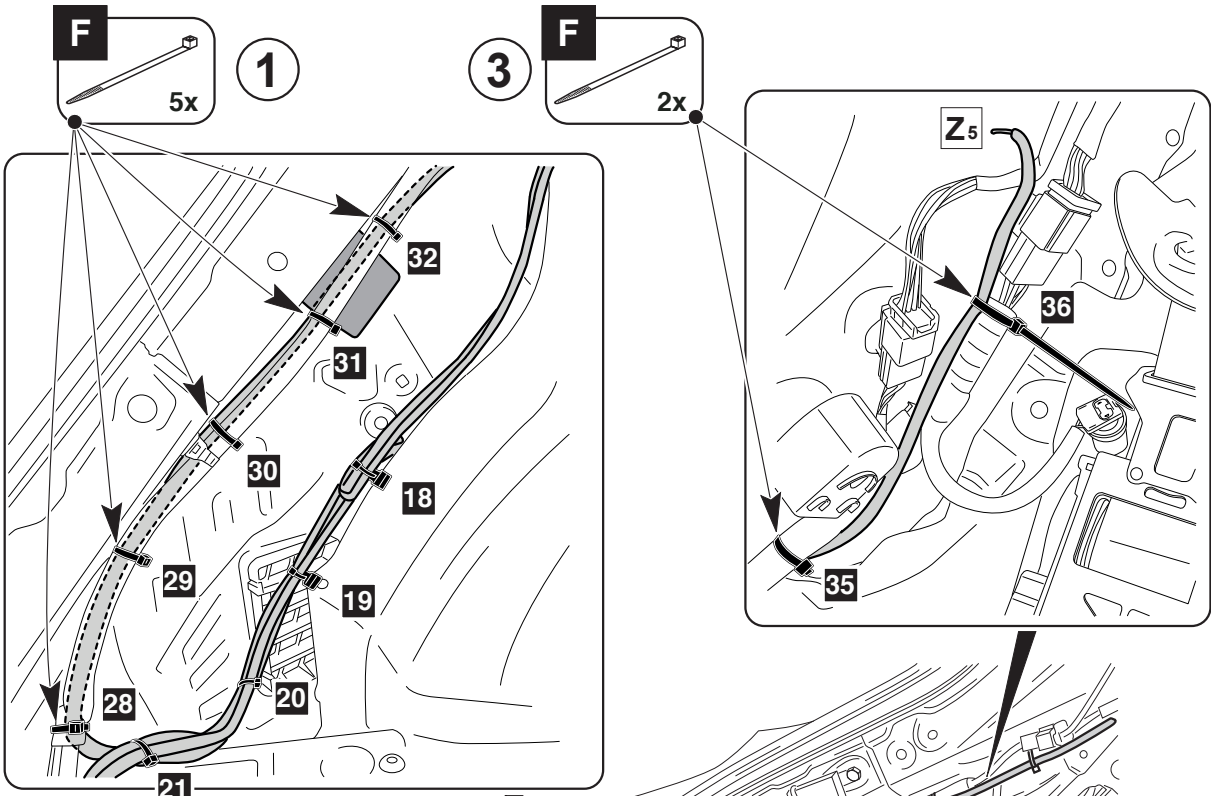

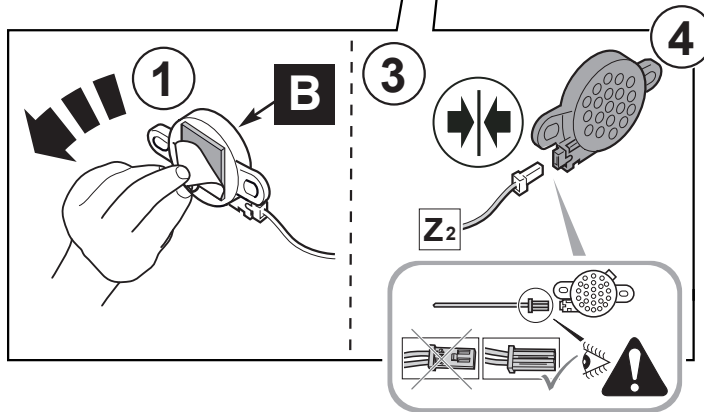
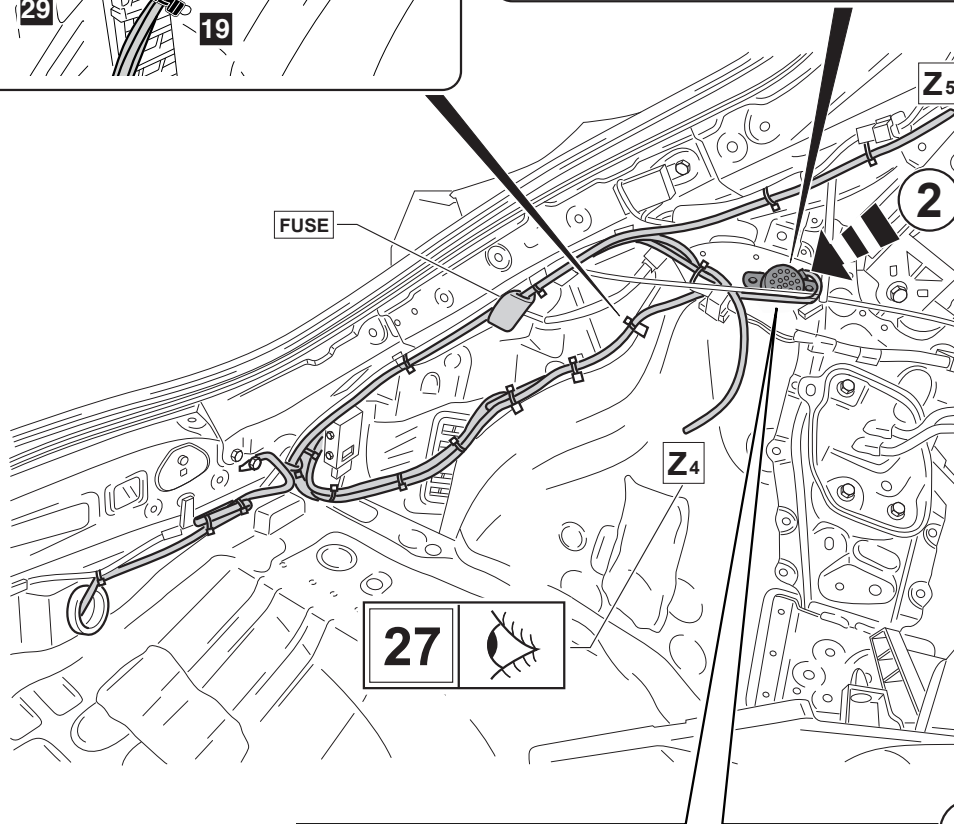
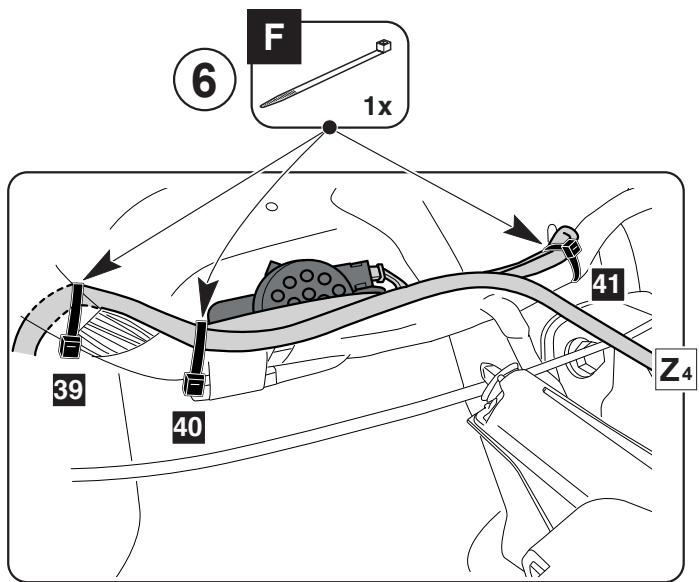
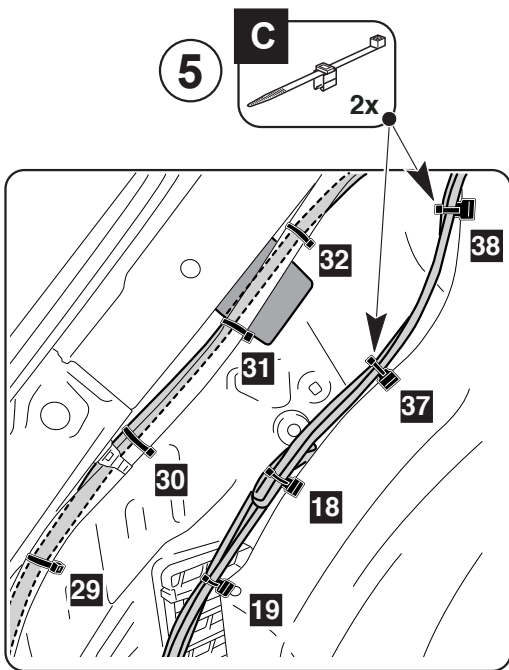

T9580

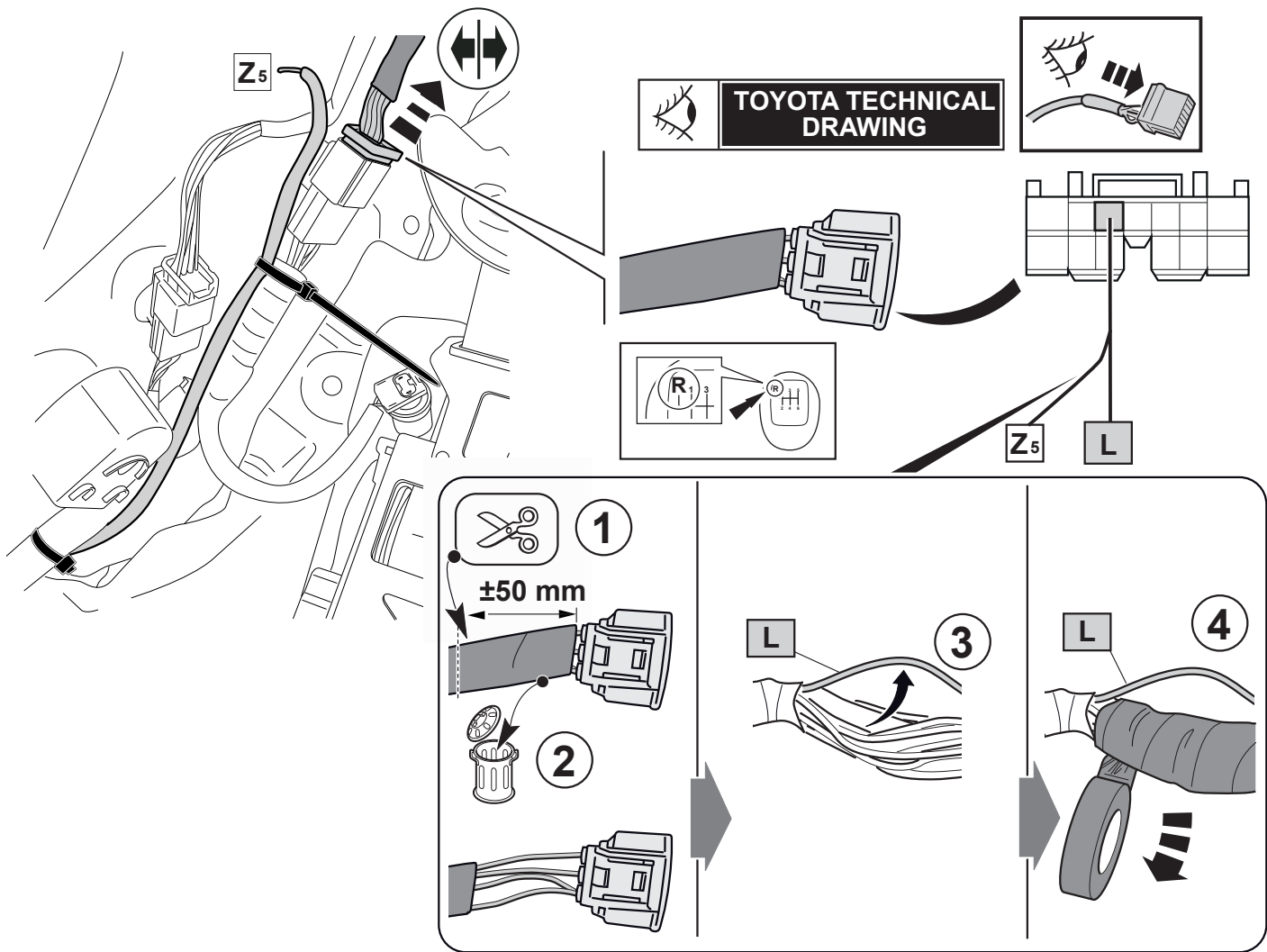

T10178

PW501-00583

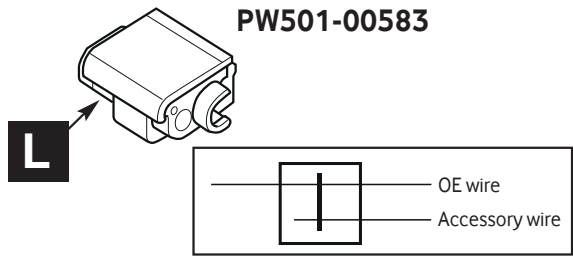

Only applicable for Copper wires

558	Wire range (mm ²)		Wire insulation diameter (mm)
	Min.	Max.	
OE wire	0,35	1,5	3
Accessory wire	0,35	1,5	3

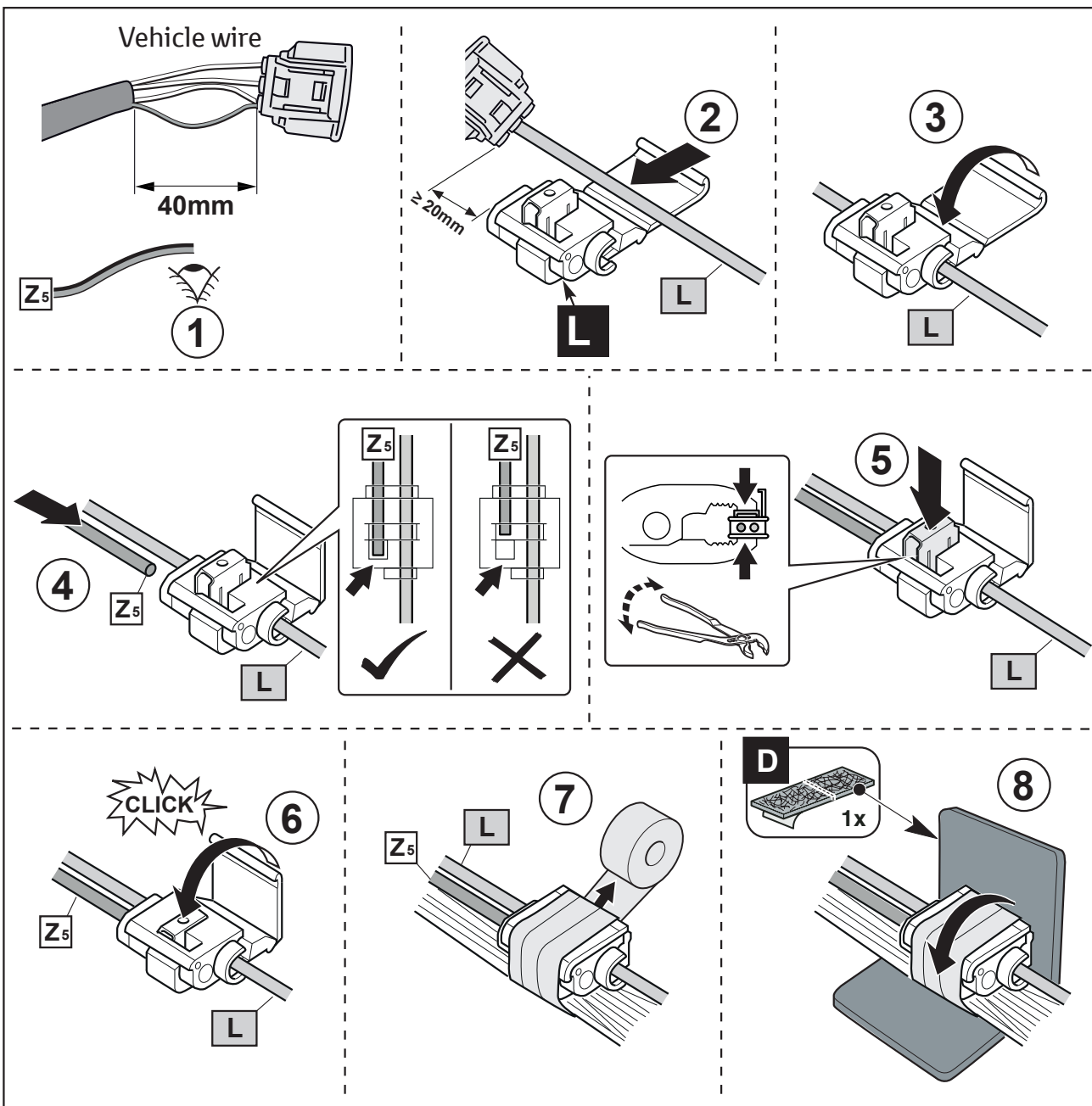

T9855

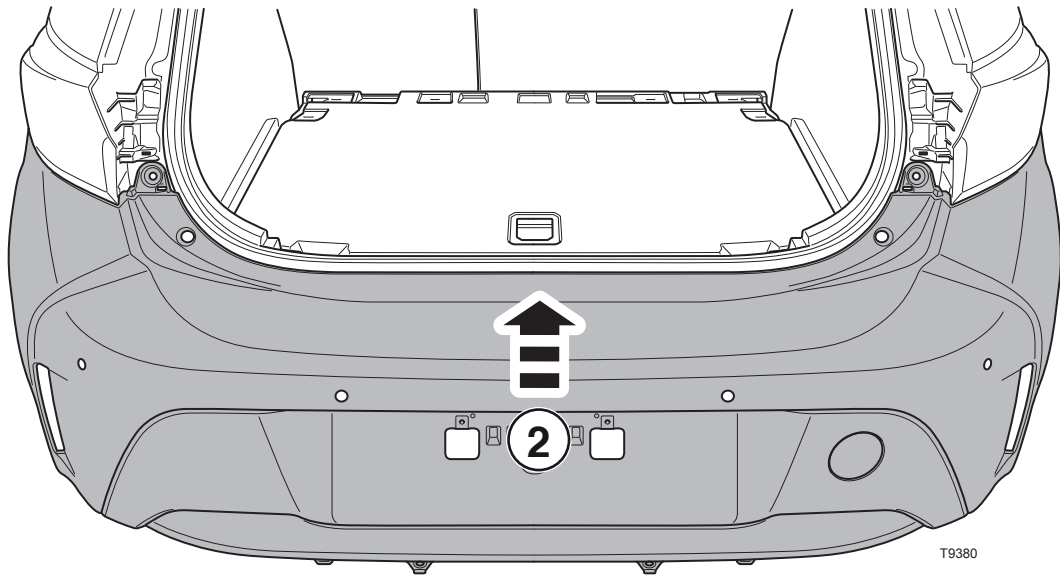
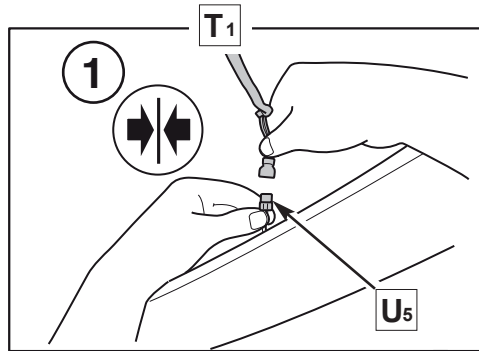

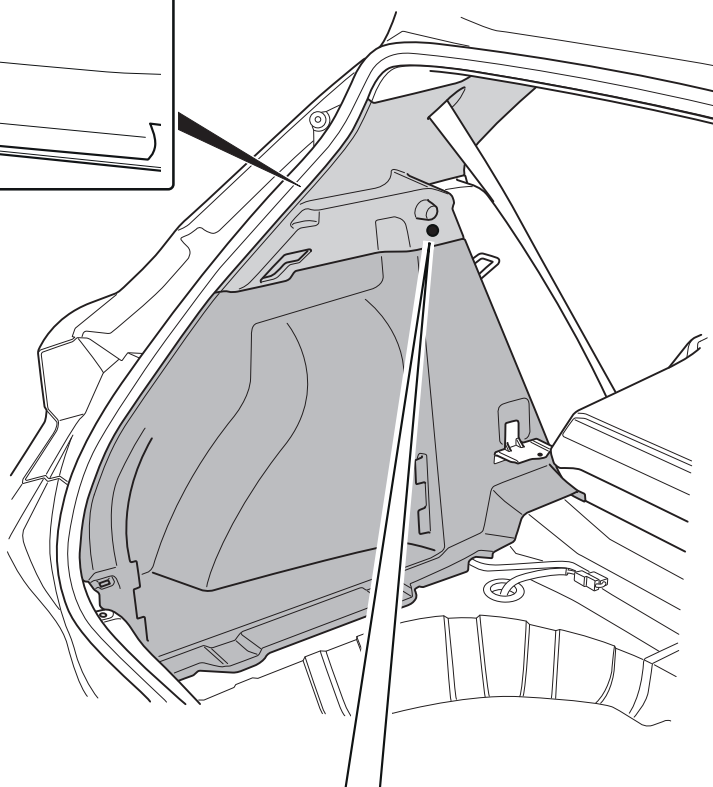
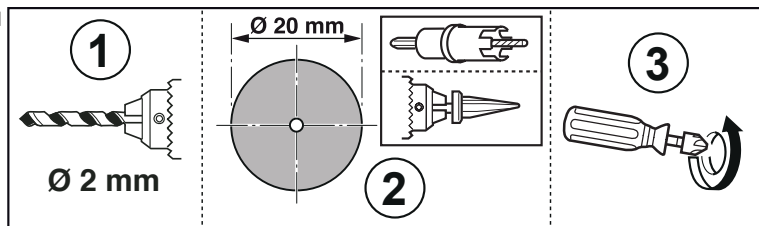
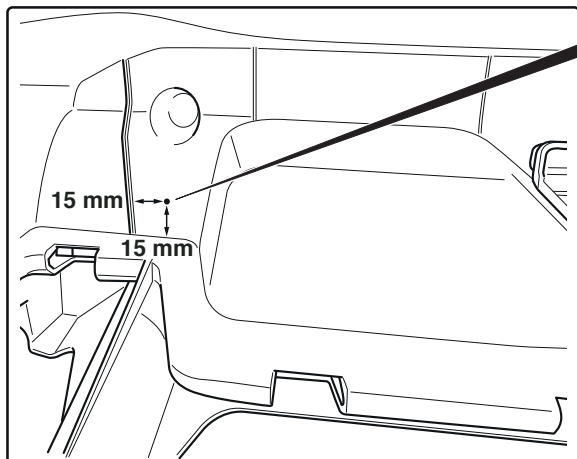

OPTIONAL



T9382

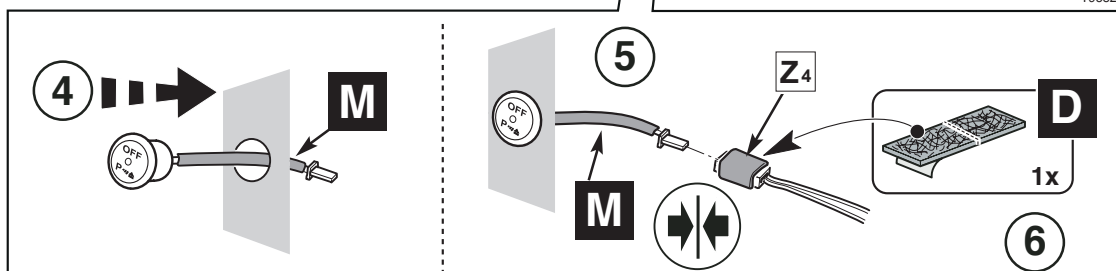

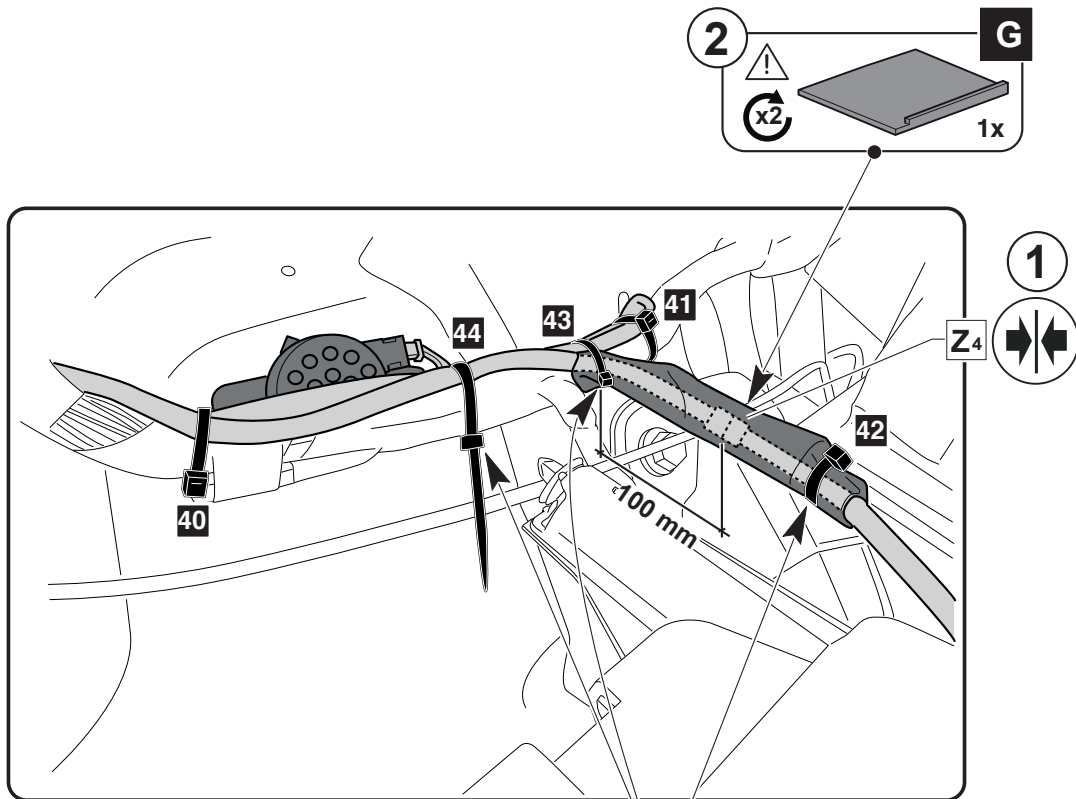

OPTIONAL

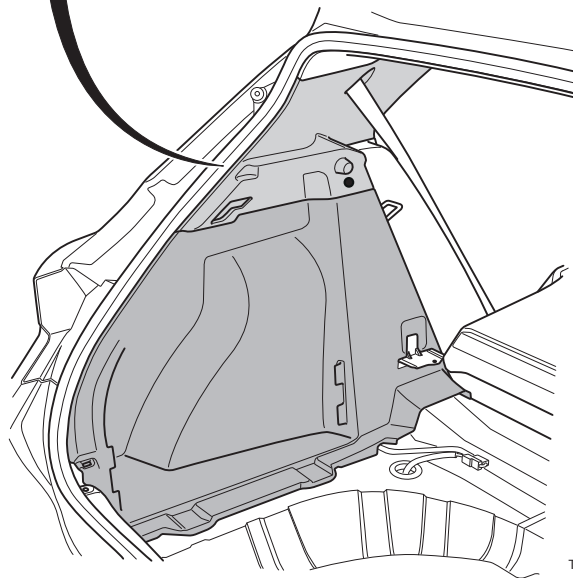
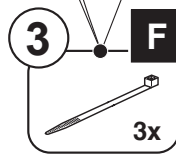

T9856

28

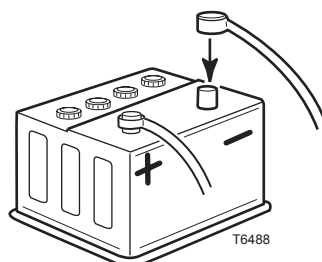
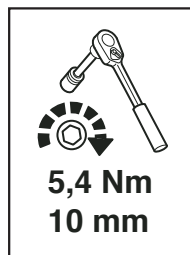

29

CHECK SHEET

Page 1/2



TOYOTA

Model / Year

Corolla 2019/01



TPA Rear

DURING INSTALLATION

ALWAYS A BETTER WAY

VIN n°

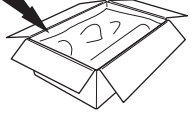
P/N = OK

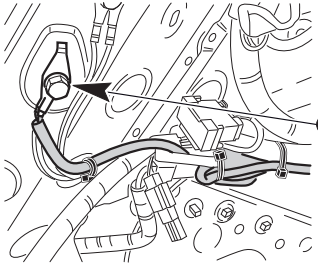
Z₃

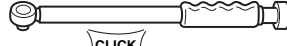

Serial Number

8,5 Nm

2x
37 Nm **A** **B**

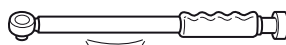

Serial Number

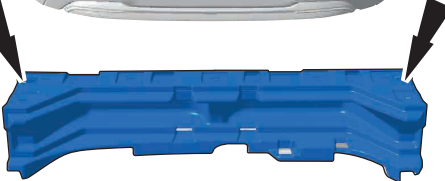
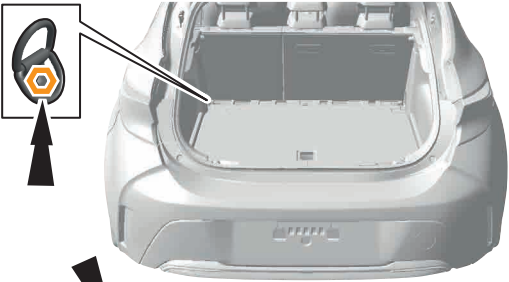

5x
6 Nm

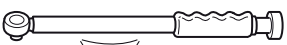

Serial Number

Installation Date:
... / ... / ...

Technician Name & Signature:

Stamp:

CHECK SHEET

Page 2/2



TOYOTA

ALWAYS A BETTER WAY

Model / Year

Corolla 2019/01

TPA Rear

AFTER INSTALLATION

VIN n°

4

S !
 1x
 18 Nm A B

Serial Number

T1-T2-T3-T4

Beep

ON

OFF

= OK

Serial Number

5.4 Nm

2

DIAGNOSTIC TOOL

NO DTC = OK

Installation Date:

... / ... / ...

Technician Name & Signature:

Stamp: