



TOYOTA

ALWAYS A
BETTER WAY

Prius (RHD)

Tilt Sensor

Installation instructions

Model year:	2003	
Vehicle code:	NHW20R - AHEEBW	
Part number:	PW625 - 00101	Tilt sensor base kit
	PW625 - 00201	Kit sensor optional extension kit battery backup siren

Manual reference number: AIM 004 705-0

EN

- Expert Fitment Required.
- Disconnect the battery earth cable.
- To avoid damage to the wiring harness, ensure contact with sharp edges is prevented.
- Install parts as shown on illustrations.
- Re-connect battery.
- Re-fit panels, ensure that the wiring harness and other components are neatly and securely located.

ES

- Montaje sólo por el concesionario.
- Desconectar el cable de masa de la batería.
- A efectos de evitar desperfectos en el aislamiento del cable, hay que evitar el contacto con aristas cortantes.
- Montar las piezas tal como se indica en las figuras.
- Vuelva a conectar la batería.
- Volver a colocar los paneles; preste atención a que el mazo del cable y las demás piezas tengan la posición correcta y precisa.

IT

- E' necessario in officina specializzata.
- Staccare il cavo di massa dalla batteria
- Allo scopo di evitare danni all'isolazione dei cavi, evitare di metterli a contatto con spigoli acuti.
- Montare le parti secondo quanto rilevabile delle illustrazioni.
- Riconnettere la batteria.
- Rimettere in posizione i pannelli; far ben attenzione che il fascio di cavi e le altre parti siano state posizionate con esattezza e nella dovuta maniera.

NL

- Montage door vakman nodig.
- Massakabel van accu losmaken.
- Ter vermindering van beschadiging aan de isolatie van de elektrokit dient contact met scherpe kanten te worden vermeden.
- Delen overeenkomstig afbeelding monteren.
- Accu weer aansluiten.
- Panelen weer monteren; let erop, dat de kabelboom en andere delen correct en netjes gepositioneerd worden.

NO

- Nødvendig med montering fra fagverksted.
- Klem jordkabelen av batteriet.
- For å unngå skader på kabelisoleringen må berøring av skarpe kanter unngås.
- Monter alle deler i henhold til illustrasjonene.
- Tilkoppl batteriet igjen.
- Monter panelene igjen, og pass på at kabelbunten og andre deler er anbrakt ordentlig og på riktig sted.

FI

- Asennus tarpeen merkkikorjaamossa.
- Erotta maadoitusjohto akusta
- Pidä huoli myös siitä, että kaapelointi on korin kiinnityksen myötäinen ja kiinnitetty huolellisesti muihin liikkuviin osiin.
- Asenna osat kuvien mukaan.
- Kytke akku takaisin.
- Aseta paneelit paikalleen; tarkista, että kaapelointi ja muut osat ovat asianmukaisesti ja tarkalleen paikoillaan.

DE

- Montage durch Fachwerkstatt erforderlich.
- Massekabel von Batterie abklemmen.
- Zur Vermeidung von Beschädigungen an der Kabelisolierung ist Berührung mit scharfen Kanten zu vermeiden.
- Teile gemäß Abbildung montieren.
- Batterie wieder anschließen.
- Paneele wieder anbringen; achten Sie darauf, dass der Kabelbaum und andere Teile ordnungsgemäß und genau positioniert sind.

FR

- Montage par spécialiste nécessaire.
- Débrancher le câble de masse de la batterie.
- Éviter tout contact avec des arêtes vives afin de ne pas endommager l'isolation des câbles.
- Monter les pièces selon les figures.
- Reconnecter la batterie.
- Remettre le panneau; veillez à ce que le faisceau et les autres pièces soient positionnés correctement et avec la précision requise.

PT

- Especialista em montagem requerido.
- Separe o cabo de terra do acumulador.
- Para não se danificar a isolamento dos cabos, é conveniente evitar-se contacto com arestas afiadas.
- Monte as partes conforme ilustrado.
- Recolocar a bateria
- Tornar a colocar os painéis; verificar se a árvore de cabos e outras peças estão na posição exacta e prescrita.

DA

- Montage ved professionelt værksted påkrævet.
- Stelkabel fjernes fra batteri.
- Berøring med skarpe kanter skal undgås for at undgå beskadigelse af kabelisoleringen.
- Dele skal monteres i henhold til illustrationer.
- Tilslut batteri igen.
- Paneler fastgøres igen; vær opmærksom på, at kabelsamlingen og andre dele placeres korrekt og præcist.

SV

- Verkstadsmontage erfordras.
- Lossa stomkabeln från batteriet.
- För att förhindra skador på ledningarnas isolation skall berøring med vassa kanter undvikas.
- Montera detaljerna enligt figurerna
- Anslut batteriet igen.
- Sätt tillbaka panelerna igen; kontrollera noga att ledningsmattan och andra detaljer ligger på rätt plats.

CS

- Montáž ve specializované dílně nutná.
- Odpojte zemnicí kabel od baterie.
- Zabraňte tomu, aby se kabely poškodily tím, že jsou položeny na ostrých hranách.
- Montujte části podle vyobrazení
- Opět připojte baterii.
- Opět připevněte panely; dbejte na to, aby svazek kabelů a ostatní části byly uloženy na správném místě.

HU

- A szereléshez szakműhely kell.
- Húzza le az akkumulátor testkábeljét.
- A kábelszigetelés megsérülésének elkerülésére ügyeljen arra, hogy a kábel ne juthasson érintkezésbe éles peremű alkatrészekkel.
- Az alkatrészeket az ábrák szerint szerelje be.
- Ismét csatlakoztassa az akkumulátort.
- Szerelje vissza a fedőlapokat, ügyeljen arra, hogy a ábelek és a többi alkatrészek pontosan a számkra kijelölt helyen maradjanak.

EL

- Η τοποθέτηση να γίνει MONO από εξουσιοδοτημένο συνεργείο
- Αποσυνδέστε το καλώδιο της γείωσης από την μπαταρία
- Για να αποφευχθούν φθορές στη μόνωση των καλωδίων, βεβαιωθείτε ότι αυτά δεν έρχονται σε επαφή με αιχμηρά σημεία
- Τοποθετήστε τα εξαρτήματα σύμφωνα με τα σχέδια
- Συνδέστε πάλι την μπαταρία
- Τοποθετήστε πάλι τα διάφορα πλαίσια – ΠΡΟΣΟΧΗ: η πλεξούδα καθώς και τα υπόλοιπα εξαρτήματα να τοποθετηθούν οργανωμένα, με ασφάλεια και σύμφωνα με τους κανονισμούς

TR

- Uzmanın takması gereklidir.
- Akü toprak kablosunu ayırın.
- Kablo demetinin hasar görmemesi için, sivri objelerle temasın engellenmesini sağlayın.
- Parçaları çizimlerde gösterildiği gibi takın.
- Aküyü tekrar bağlayın.
- Panoları tekrar takın, kablo demeti ve diğer komponentlerin tam ve sıkıca yerleşmesini sağlayın.

ET

- Paigaldada spetsialisti poolt.
- Võtke massikaabel aku küljest lahti.
- Juhtmestiku kahjustamise vältimiseks hoidke juhtmed eemal teravatest servadest.
- Paigaldage osad vastavalt joonistele.
- Ühendage aku.
- Paigaldage kattepaneelid; veenduge, et juhtmestik ja muud osad on paigutatud korrektselt ning kindlalt.

LT

- Būtina, kad sumontuotų specialistas.
- Atjunkite akumulatoriaus įžeminimo laidą.
- Tam, kad išvengtumėte įvado apgadinimo, saugokite, kad laidai nesiliestų prie aštrių briaunų.
- Sumontuokite dalis taip, kaip pavaizduota iliustracijoje.
- Prijunkite akumuliatorių.
- Į vietas įdėkite skydelius, patikrinkite, ar laidų šarvai ir kiti komponentai yra savo vietose ir gerai pritvirtinti.

SL

- Potrebna je strokovna montaža.
- Odklopite ozemljitveni kabel akumulatorja.
- Da preprečite poškodbe kableskega snopa, preprečite stik z ostrimi robovi.
- Dele namestite, kot je prikazano na slikah.
- Ponovno priklpite akumulator.
- Ponovno montirajte panele in zagotovite, da so kabelski snop in druge komponente nameščene varno.

PL

- Konieczny montaż przez warsztat specjalistyczny.
- Odłączyć przewód masy od akumulatora.
- Dla zapobieżenia uszkodzeniu izolacji chronić przed zetknięciem z ostrymi krawędziami.
- Zamontować części zgodnie z rysunkiem.
- Ponownie podłączyć akumulator.
- Na powrót osadzić osłony; zadbać aby wiązka kablowa i inne części były właściwie i dokładnie ułożone.

RU

- Монтаж должны выполнять специалисты в мастерской
- Отсоединить заземляющий кабель аккумулятора
- Во избежание повреждений изоляции кабеля не допускать соприкосновения с острыми углами
- Монтировать части согласно иллюстрации
- Снова подключить аккумулятор
- Установить панель, проверить правильность и точность расположения кабелей и других частей.

BG

- Изисква се поставяне от специалист.
- Откачете заземяващия кабел на акумулатора.
- За избягване на повреди по кабелния сноп се уверете, че няма контакт с остри ръбове.
- Монтирайте частите според показаното на илюстрацията.
- Свържете отново акумулатора.
- Поставете отново панелите, уверете се, че кабелният сноп и останалите компоненти са разположени подредено и надеждно.

LV

- Nepieciešami īpaši saliekamie elementi.
- Atvienojiet akumulatora zemējuma vadu.
- Lai nesabojātu elektroinstalāciju, nepieskarieties tai ar asiem priekšmetiem.
- Uzstādiet detaļas, kā parādīts attēlos.
- Pievienojiet akumulatoru.
- Uzlieciet paneļus, raugieties, lai elektroinstalācija un citas daļas būtu kārtīgi un stingri nofiksētas.

RO

- Este necesară instalarea de către un specialist.
- Deconectați cablul de împământare a bateriei.
- Pentru a evita deteriorarea cablajului, evitați contactul cu muchiile ascuțite.
- Montați componentele așa cum este prezentat în figuri.
- Reconectați bateria
- Reinstalați panourile, aveți grijă de plasarea îngrijită și în condiții de siguranță a cablajului și a celorlalte componente.

SK





- Vyžaduje sa profesionálne vybavenie.
- Odpojte zemniaci vodič akumulátora.
- Káblové zväzky sa nesmú dotýkať ostrých okrajov, aby sa nepoškodili.
- Dielce založte tak, ako je znázornené na obrázkoch.
- Znovu zapojte akumulátor.
- Založte panely a uistite sa, že káblové zväzky a iné dielce sú bezpečne a prehľadne uložené.



	EN	DE	ES	FR	IT	PT	NL	DA	NO	SV	FI	CS
L	Blue	Blau	Azul	Bleu	Blu	Azul	Blauw	Blå	Blå	Blå	Sininen	Modrá
B	Black	Schwarz	Negro	Noir	Nero	Preto	Zwart	Sort	Sort	Svart	Musta	Černá
BR	Brown	Braun	Marrón	Marron	Marrone	Castanho	Bruin	Brun	Brun	Brun	Ruskea	Hnědá
DL	Dark blue	Dunkelblau	Azul oscuro	Bleu foncé	Blu scuro	Azul-escuro	Donkerblauw	Mørkeblå	Mørkeblå	Mørkblå	Tummansininen	Tmavomodrá
DG	Dark green	Dunkelgrün	Verde oscuro	Vert foncé	Verde scuro	Verde-escuro	Donkergrøen	Mørkegrøn	Mørkegrønn	Mörkgrön	Tummanvihreä	Tmavozelená
G	Green	Grün	Verde	Vert	Verde	Verde	Groen	Grøn	Grønn	Grön	Vihreä	Zelená
GR	Grey	Grau	Gris	Gris	Grigio	Cinzeno	Grijs	Grå	Grå	Grå	Harmaa	Šedá
LA	Lavender	Lavendel	Lavanda	Lavande	Lavanda	Lavanda	Lavendel	Lavendel	Lavendel	Lavendel	Laventeli	Levandulová
LB	Light blue	Hellblau	Azul claro	Bleu clair	Blu chiaro	Azul-claro	Lichtblauw	Lyseblå	Lyseblå	Ljusblå	Vaaleansininen	Bleděmodrá
LG	Light green	Hellgrün	Verde claro	Vert clair	Verde chiaro	Verde-claro	Lichtgroen	Lysegroen	Lysegroenn	Ljuskgrön	Vaaleanvihreä	Světlezelená
NO	Natural colour	Naturfarben	Color natural	Nature	Colori naturali	Cores naturais	Naturel	Naturfarvet	Naturfarger	Naturfärger	Luonnonväri	Přírodní barva
O	Orange	Orange	Naranja	Orange	Arancione	Laranja	Oranje	Orange	Orange	Orange	Oranssi	Oranžová
P	Pink	Rosa	Rosa	Rose	Rosa	Rosa	Rosé	Rosa	Rosa	Rosa	Rosa	Růžová
R	Red	Rot	Rojo	Rouge	Rosso	Vermelho	Rood	Rød	Rød	Röd	Punainen	Červená
PU	Purple	Purpur	Púrpura	Pourpre	Rosso porpora	Púrpura	Paars	Purpur	Purpur	Purpur	Purppura	Purpurová
SB	Sky blue	Himmelblau	Azul cielo	Bleu ciel	Celeste	Azul-céu	Hemelsblauw	Himmelblå	Himmelblå	Himmelsblå	Taivaansininen	Blankytá
T	Yellow brown	Gelbbraun	Amarillo-marrón	Marron-jaune	Giallomarrone	Castanho-amarelado	Geelbruin	Gulbrun	Gulbrun	Gulbrun	Keltaisenruskea	Žlutohnědá
W	White	Weiß	Blanco	Blanc	Bianco	Branco	Wit	Hvid	Hvit	Vit	Valkoinen	Bílá
Y	Yellow	Gelb	Amarillo	Jaune	Giallo	Amarelo	Geel	Gul	Gul	Gul	Keltainen	Žlutá
V	Violet	Violett	Violeta	Violet	Viola	Violeta	Violet	Violet	Fiolett	Violett	Violett	Fialová

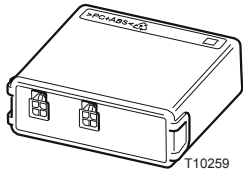
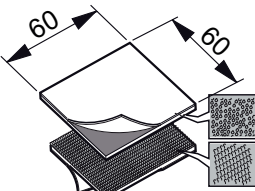
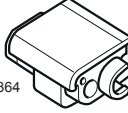
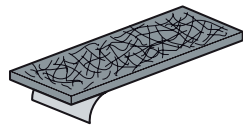

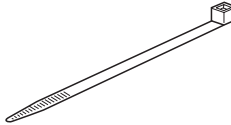
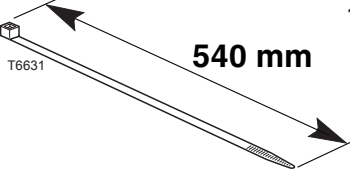
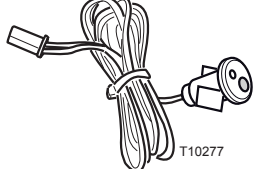
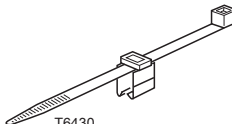
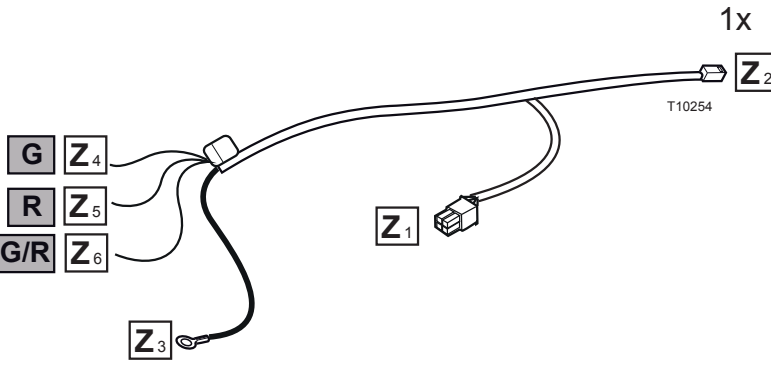

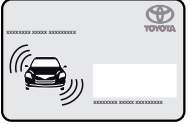

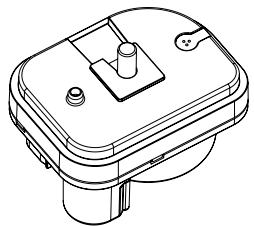
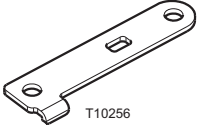

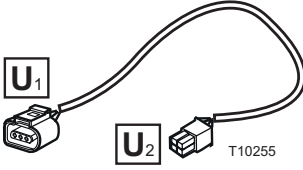
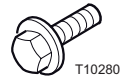

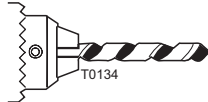
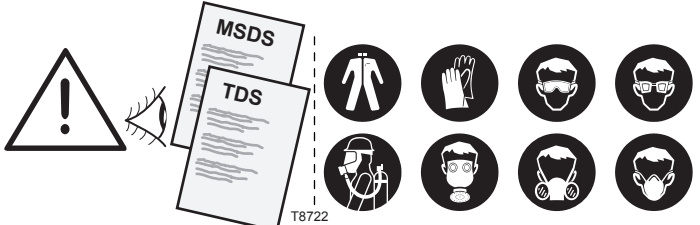
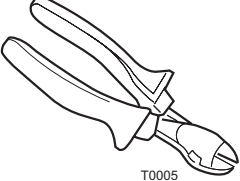
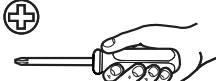

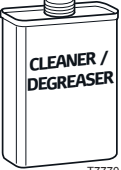
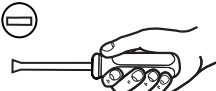

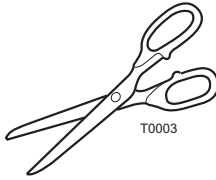
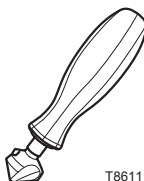
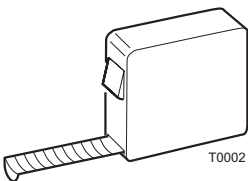
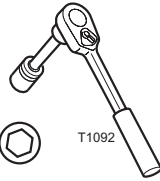











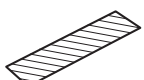

	HU	PL	EL	RU	TR	BG	ET	LV	LT	RO	SL	SK
L	Kék	Niebieska	Μπλε	Синий	Mavi	Синьо	Sinine	Zils	Mélyna	Albastru	Modra	Modrá
B	Fekete	Czarna	Μαύρο	Чёрный	Siyah	Черно	Must	Melns	Juoda	Negru	Črna	Čierna
BR	Barna	Brazowa	Καφέ	Коричневый	Kahverengi	Καφяво	Pruun	Brūns	Ruda	Maro	Rjava	Hnědá
DL	Sötétkék	Granatowa	Σκούρο Μπλε	Тёмно-синий	Koyu mavi	Тъмносиньо	Tumesinine	Tumši zils	Tamsiai mélyna	Albastru închis	Temno modra	Tmavomodrá
DG	Sötétzöld	Ciemnozielona	Σκούρο Πράσινο	Тёмно-зелёный	Koyu yesil	Тъмнозелено	Tumeroheline	Tumši zaļš	Tamsiai žalia	Verde închis	Temno zelena	Tmavozelená
G	Zöld	Zielona	Πράσινο	Зелёный	Yeşil	Зелено	Roheline	Zaļš	Žalia	Verde	Zelena	Zelená
GR	Szürke	Szara	Γκρι	Серый	Gri	Сиво	Hall	Peléks	Pilka	Gri	Siva	Sivá
LA	Levendulakék	Lawenda	Λεβάντα	Лавандовый	Lavanta	Лавандула	Lavendel	Lavanda	Lavanda	Lavandă	Sivka	Levandul'a
LB	Világoskék	Jasniebieska	Ανοιχτό Μπλε	Голубой	Acik mavi	Светлосиньо	Helesinine	Gaiši zils	Šviesiai mélyna	Albastru deschis	Svetlo modra	Svetlomodrá
LG	Világoszöld	Jasnozielona	Ανοιχτό Πράσινο	Светло-зелёный	Acik yesil	Светлозелено	Heleroheline	Gaiši zaļš	Šviesiai žalia	Verde deschis	Svetlo zelena	Svetlozelená
NO	Természetes színű	Barwy naturalne	Φυσικό Χρώμα	Телесный	Nötr	Естествен цвят	Vārītu	Dabiska krāsa	Natūrali spalva	Culoare naturală	Naravna barva	Přírodní farba
O	Narancs	Pomarańczowa	Πορτοκαλί	Оранжевый	Turuncu	Оранжево	Oranž	Oranžs	Oranžinė	Portocaliu	Oranžna	Oranžová
P	Rózsaszín	Różowa	Ροζ	Розовый	Pembe	Розово	Roosa	Rozā	Rožinė	Roz	Roza	Ružová
R	Piros	Czerwona	Κόκκινο	Красный	Kırmızı	Червено	Punane	Sarkans	Raudona	Roșu	Rdeča	Červená
PU	Biborvörös	Purpurowa	Πορφύρο	Пурпурный	Mor	Пурпурно	Tume-punane	Purpursarkans	Purpurinė	Mov	Škrlatna	Purpurová
SB	Égyszínű	Bekitna	Γαλάζιο	Небесно-голубой	Gök mavisi	Небесносиньо	Taevasinine	Debeszils	Žydra	Azuriu	Nebesno modra	Azürová
T	Sárgásbarna	Żółto-brązowa	Κίτρινο-καφέ	Жёлто-коричневый	Sari kahverengi	Жълтокафяво	Kollane-pruun	Dzeltenbrūns	Gelsvai ruda	Galben-maró	Rumeno rjava	Žltohnědá
W	Fehér	Biała	Λευκό	Белый	Beyaz	Бяло	Valge	Balts	Balta	Alb	Bela	Biela
Y	Sárga	Żółta	Κίτρινο	Жёлтый	Sarı	Жълто	Kollane	Dzeltens	Geltona	Galben	Rumena	Žitá
V	Ibolyakék	Fioletowa	Μωβ	Фиолетовый	Menekşe	Виолетово	Lilla	Violetš	Violetinė	Violet	Vijolična	Fialová

Revision record

Rev. No.	Date	Page	Step	Remarks

A  1x	B  1x	C  3x
D  2x	E  3x	F  25x
G  1x	H  1x	O  1x
Z  1x	X  2x	Y  1x

OPTIONAL			
L  1x	M  1x	N  1x	U  1x
P  1x			

 <p>T0001</p>	 <p>T0134</p> <p>Ø 3 mm Ø 10 mm</p>	 <p>T8722</p>			
 <p>T0005</p>	 <p>T0006</p>	 <p>T0007</p>	 <p>T7770</p> <p>AIM 003 516-*</p>		
 <p>T5400</p>	 <p>T3659</p>	 <p>T6239</p>	 <p>T0003</p>		
 <p>T8611</p>	 <p>T0002</p>	 <p>T1092</p> <p>10 mm</p>			
 = 	 = 	 = 	  = 	 = 	 = 
 = 	 = 	 = 	  = 	 =  START	

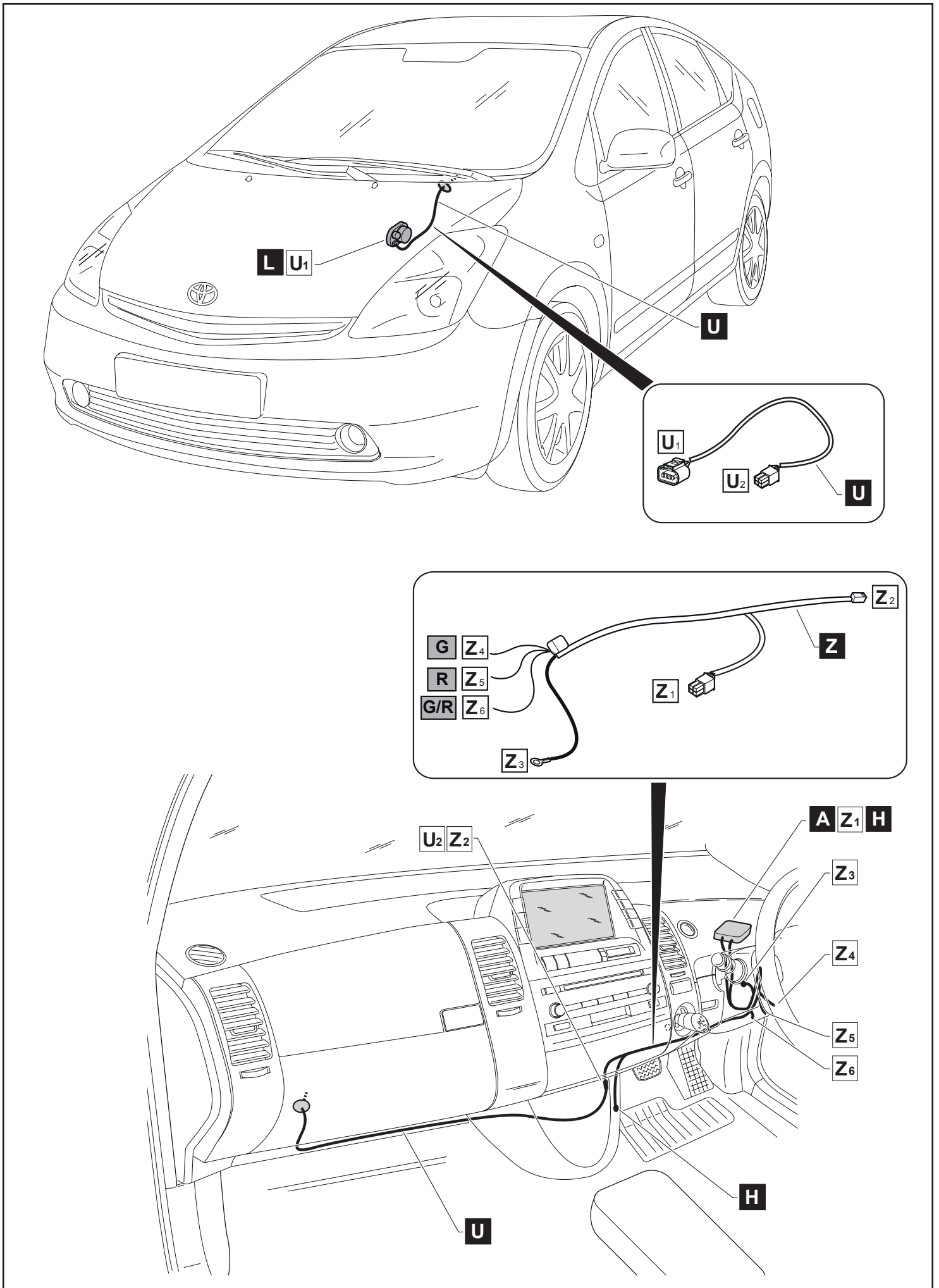

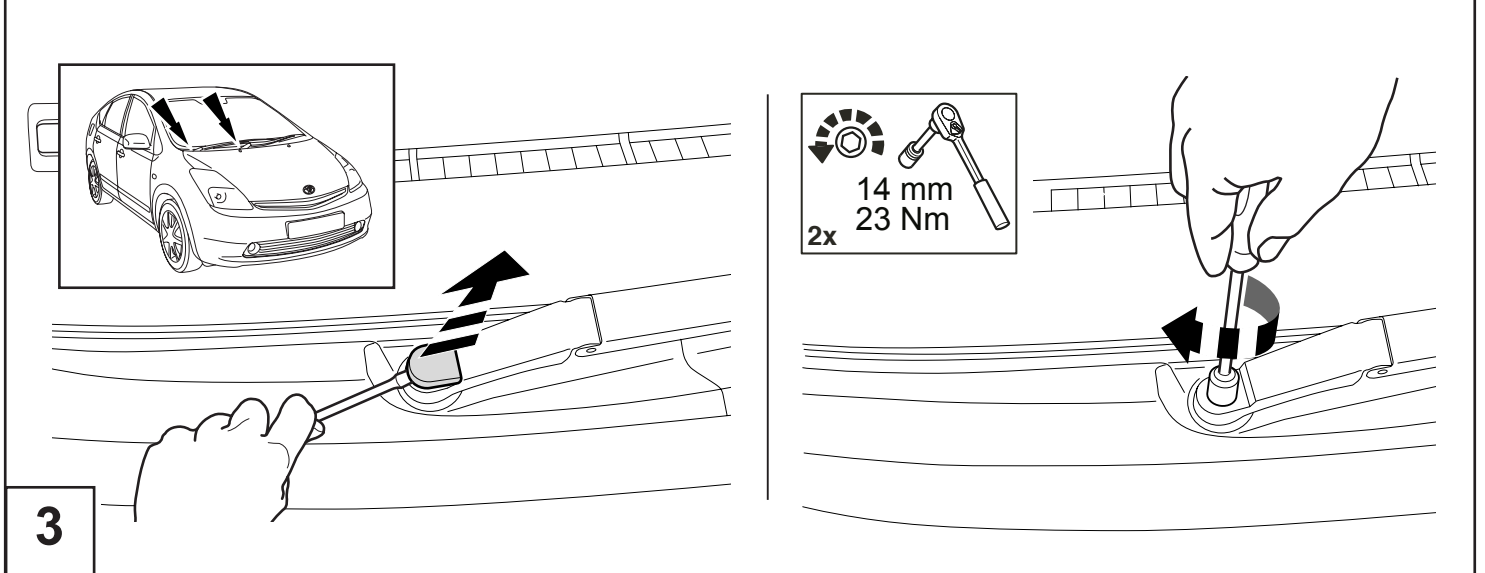
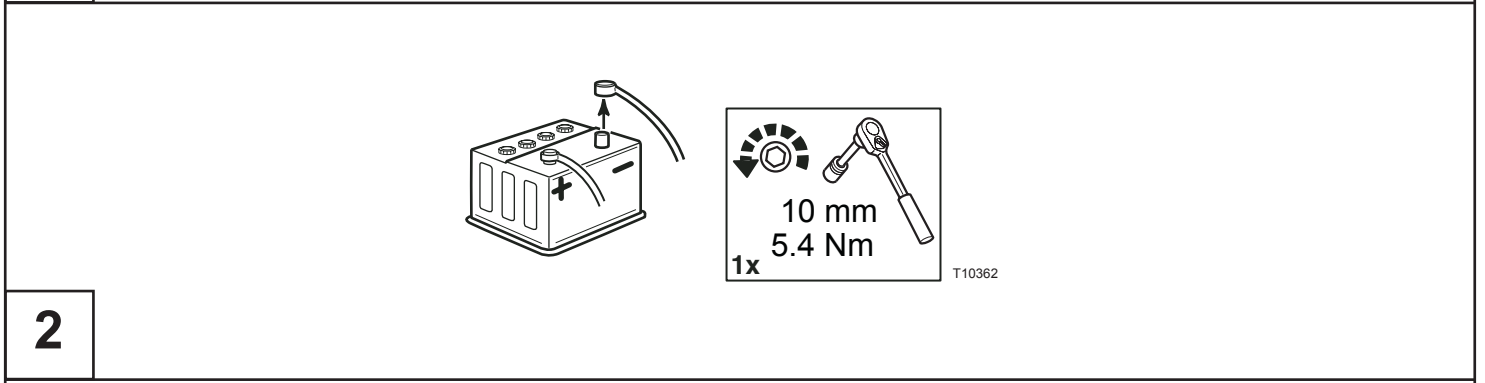
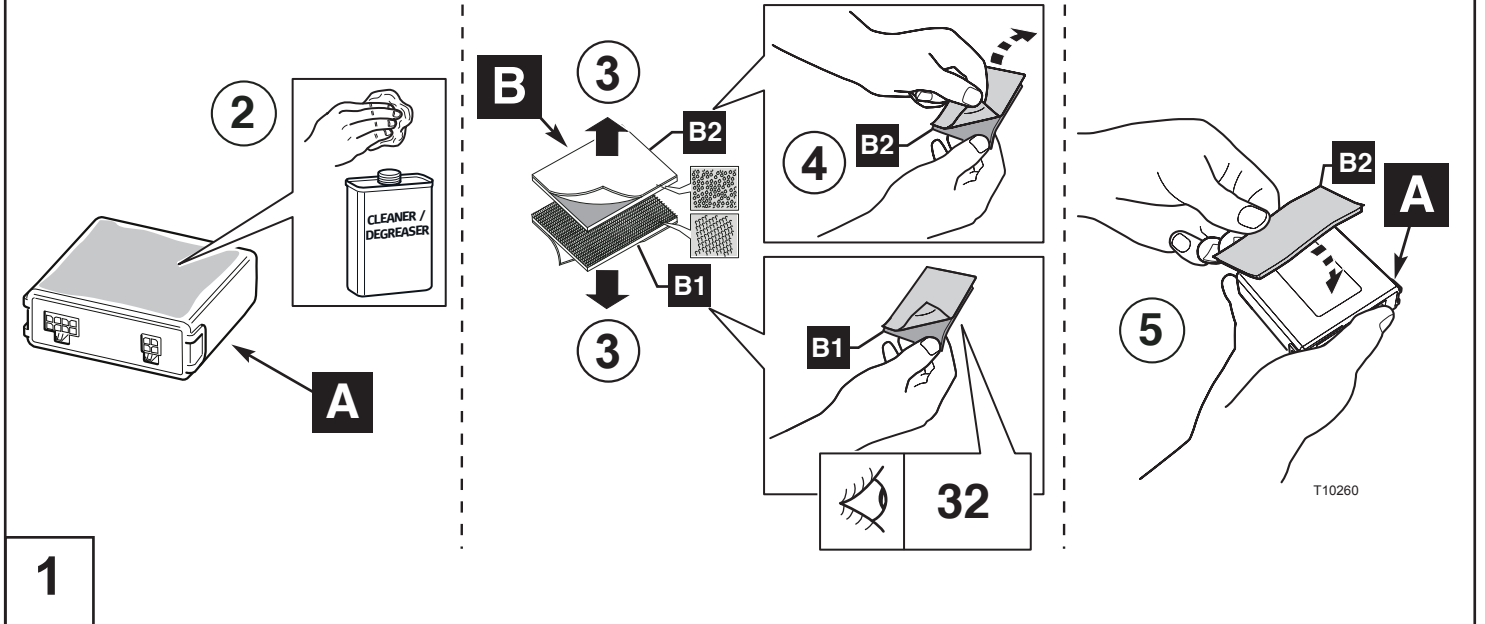
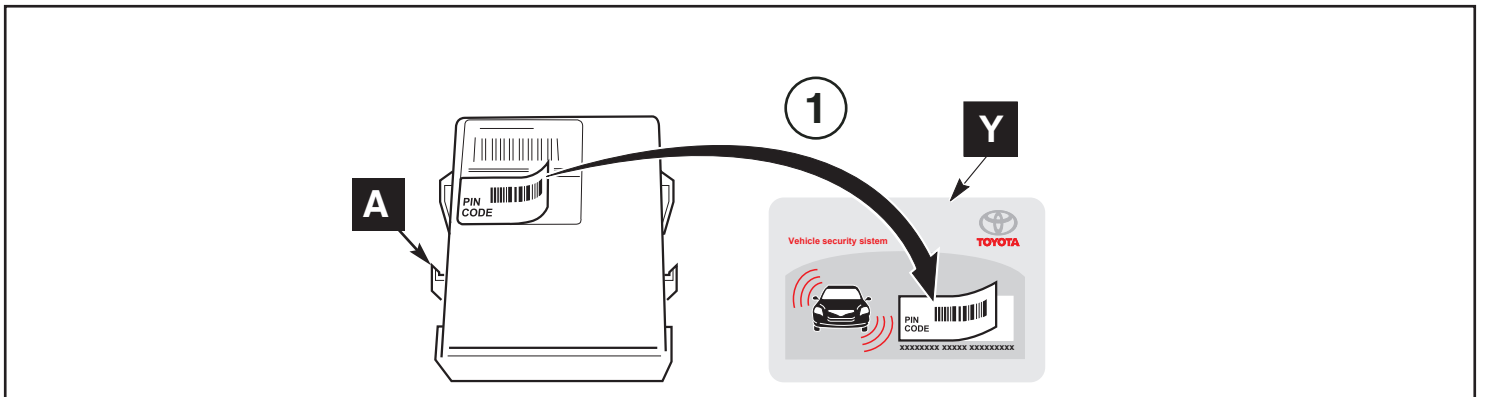

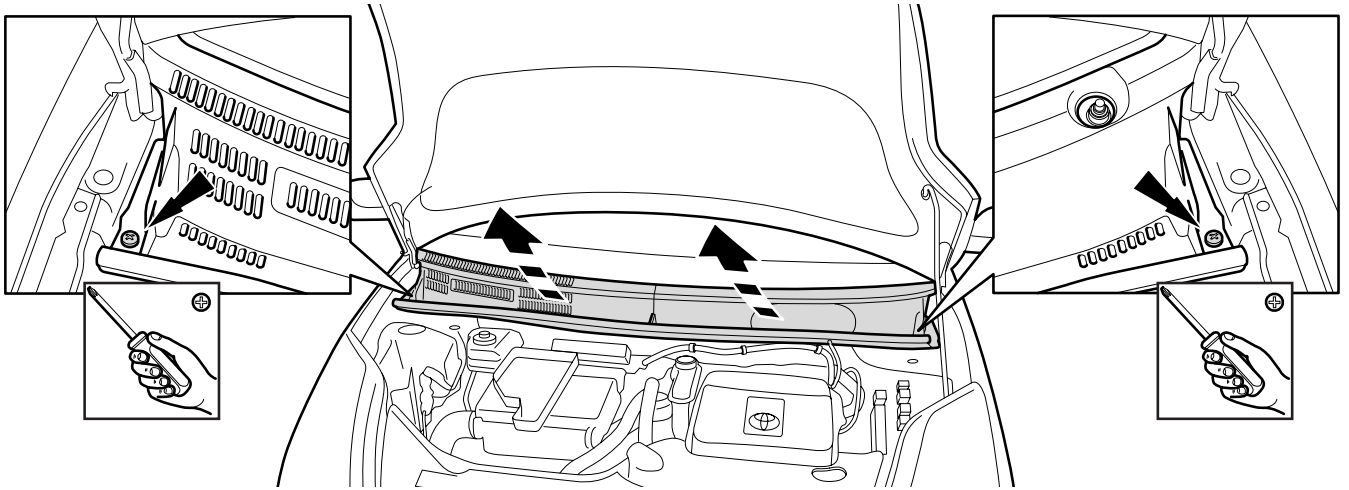

4

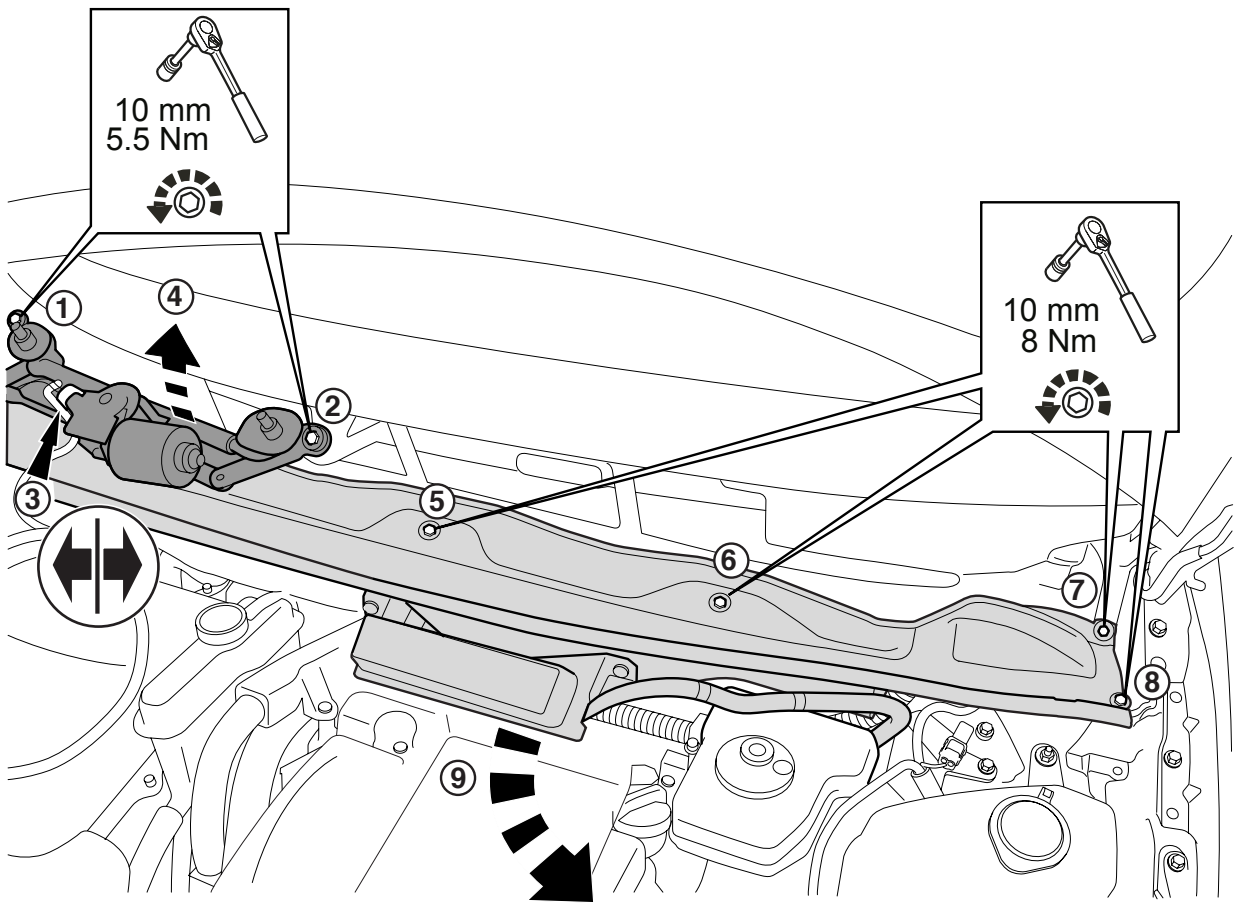

5

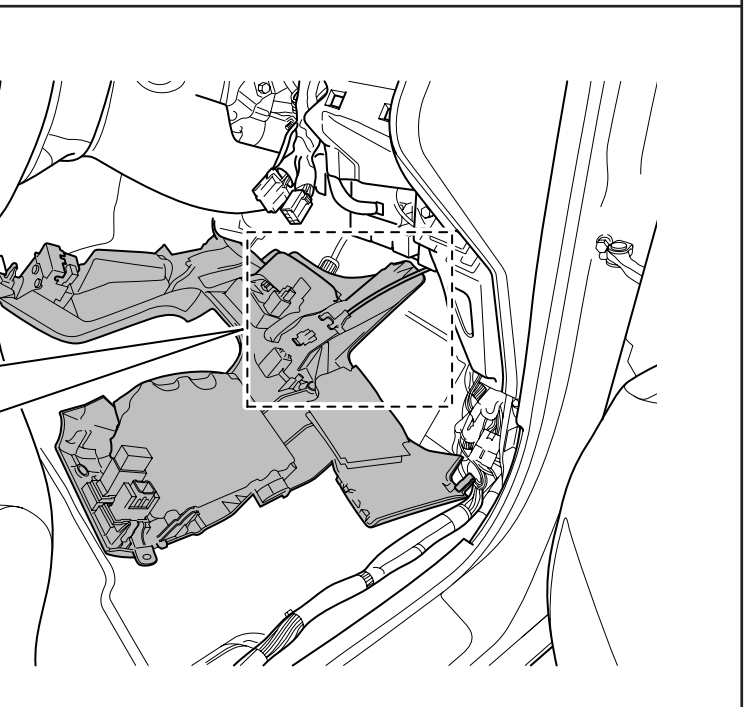
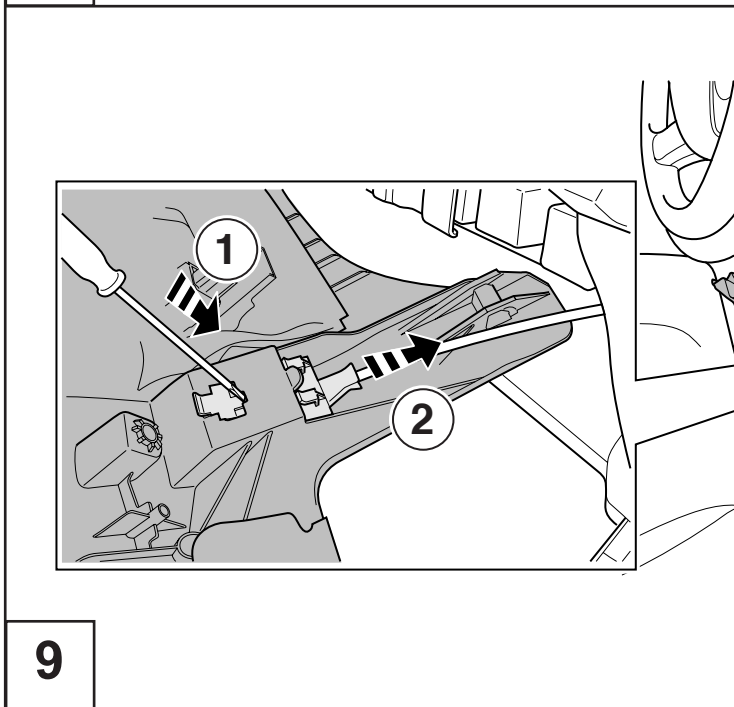
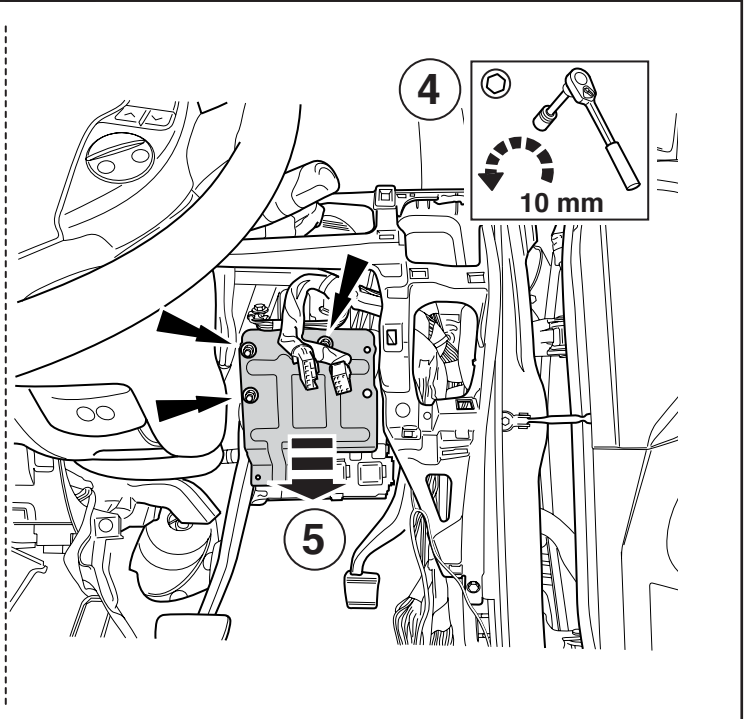
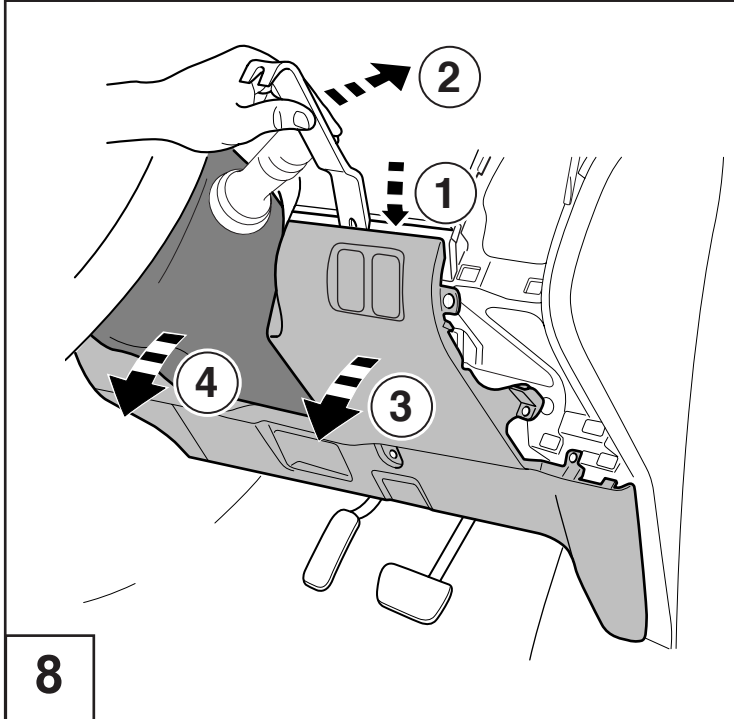
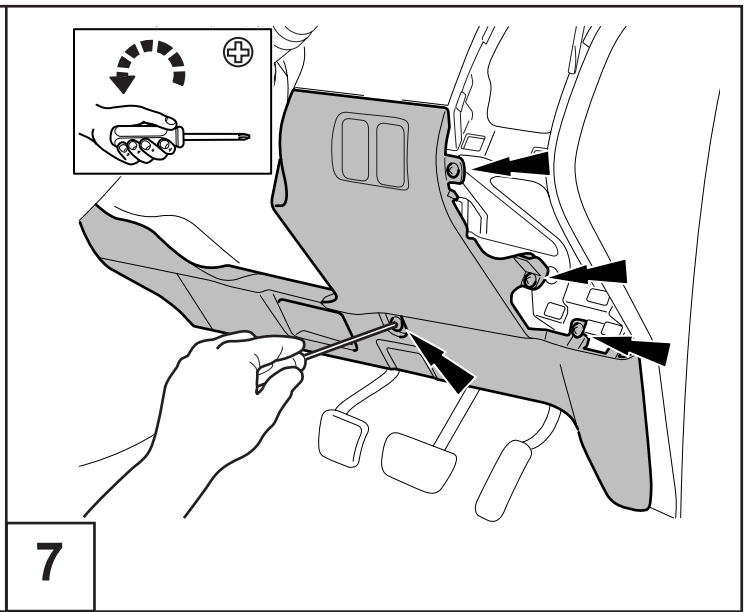
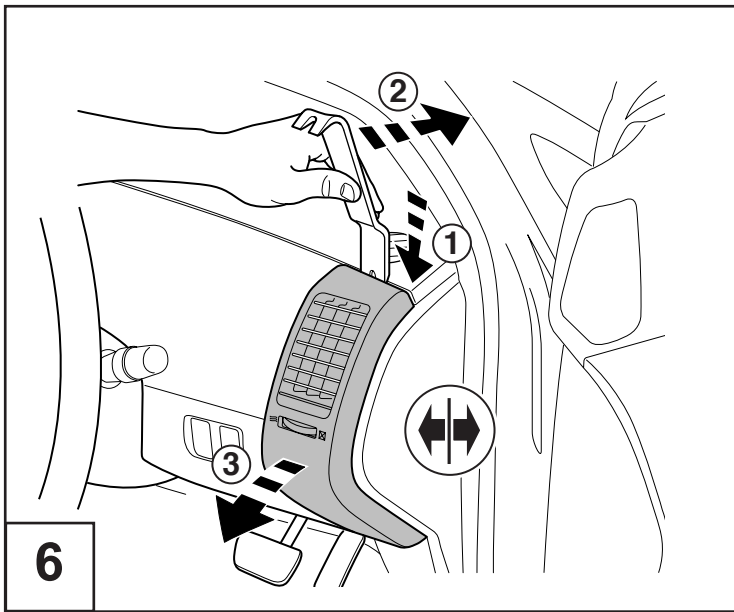

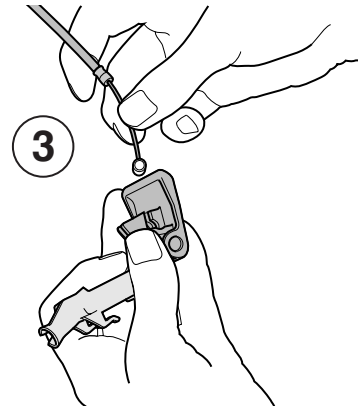
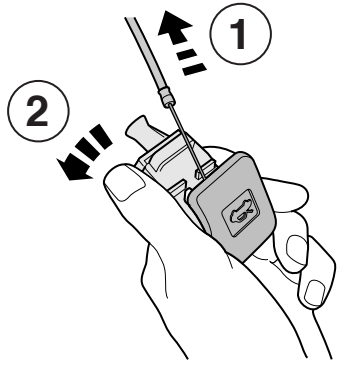

10

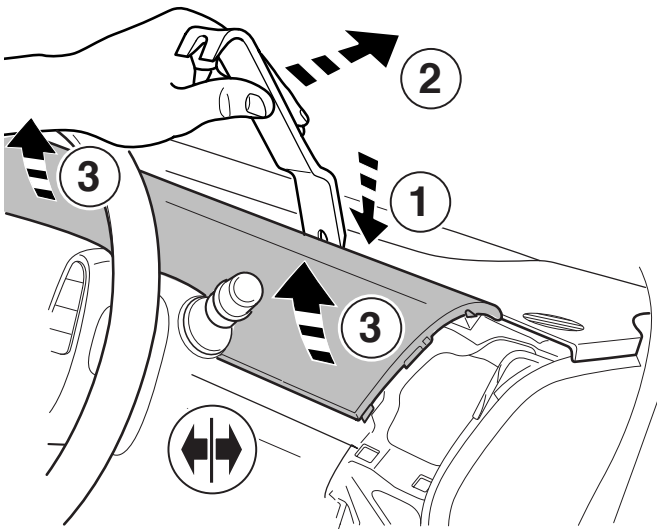

11

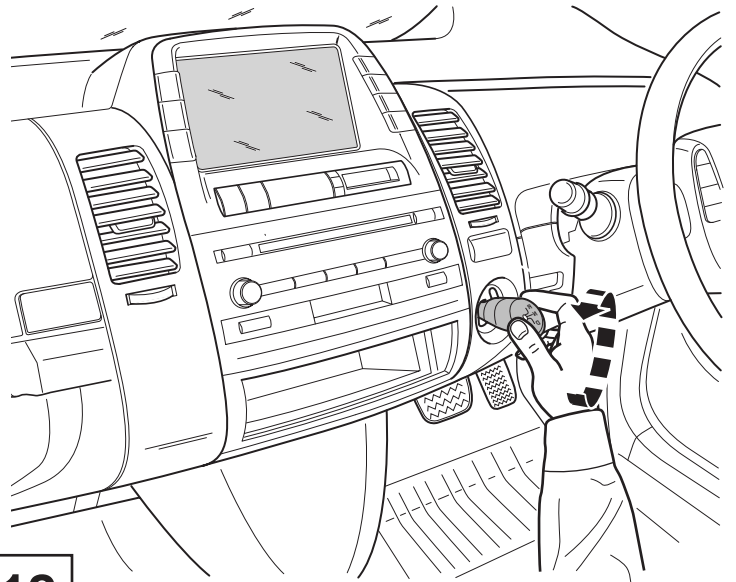

12

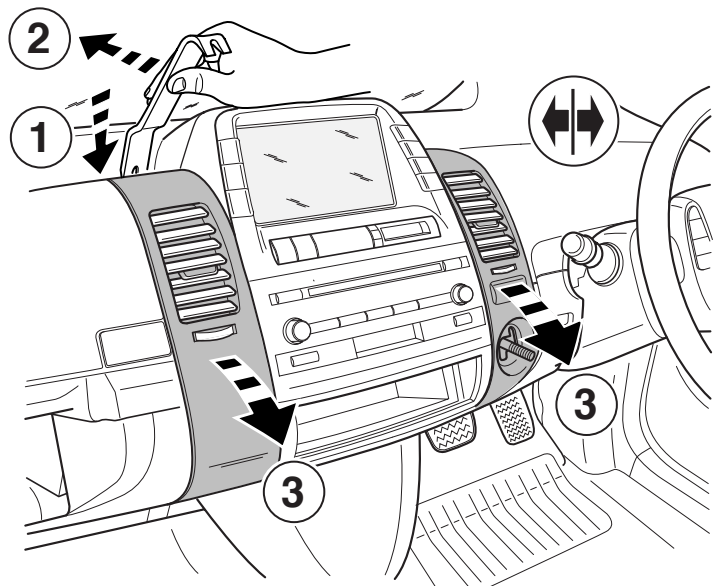
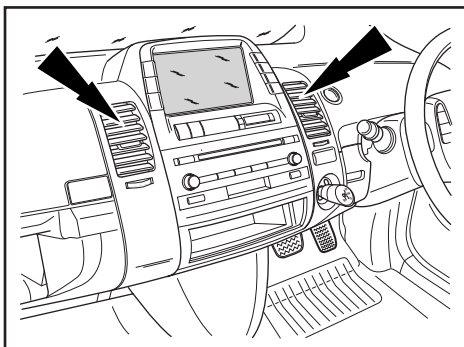

13

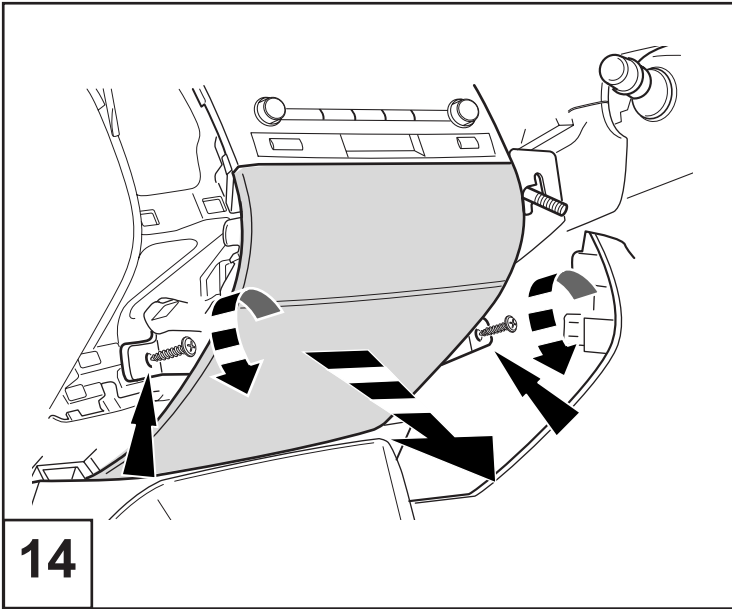

14

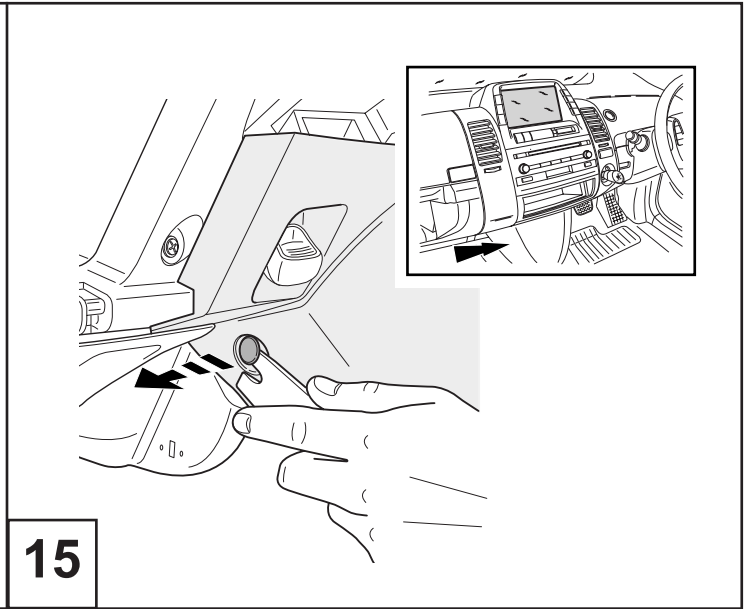

15

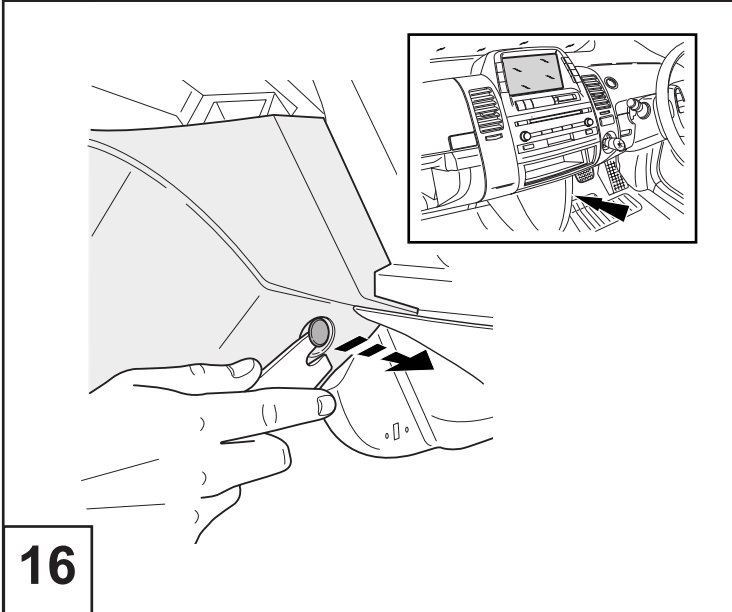

16

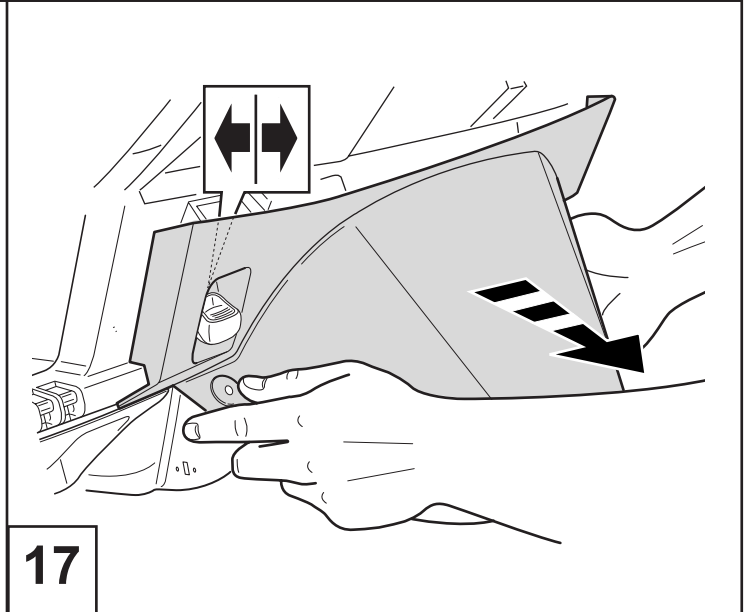

17

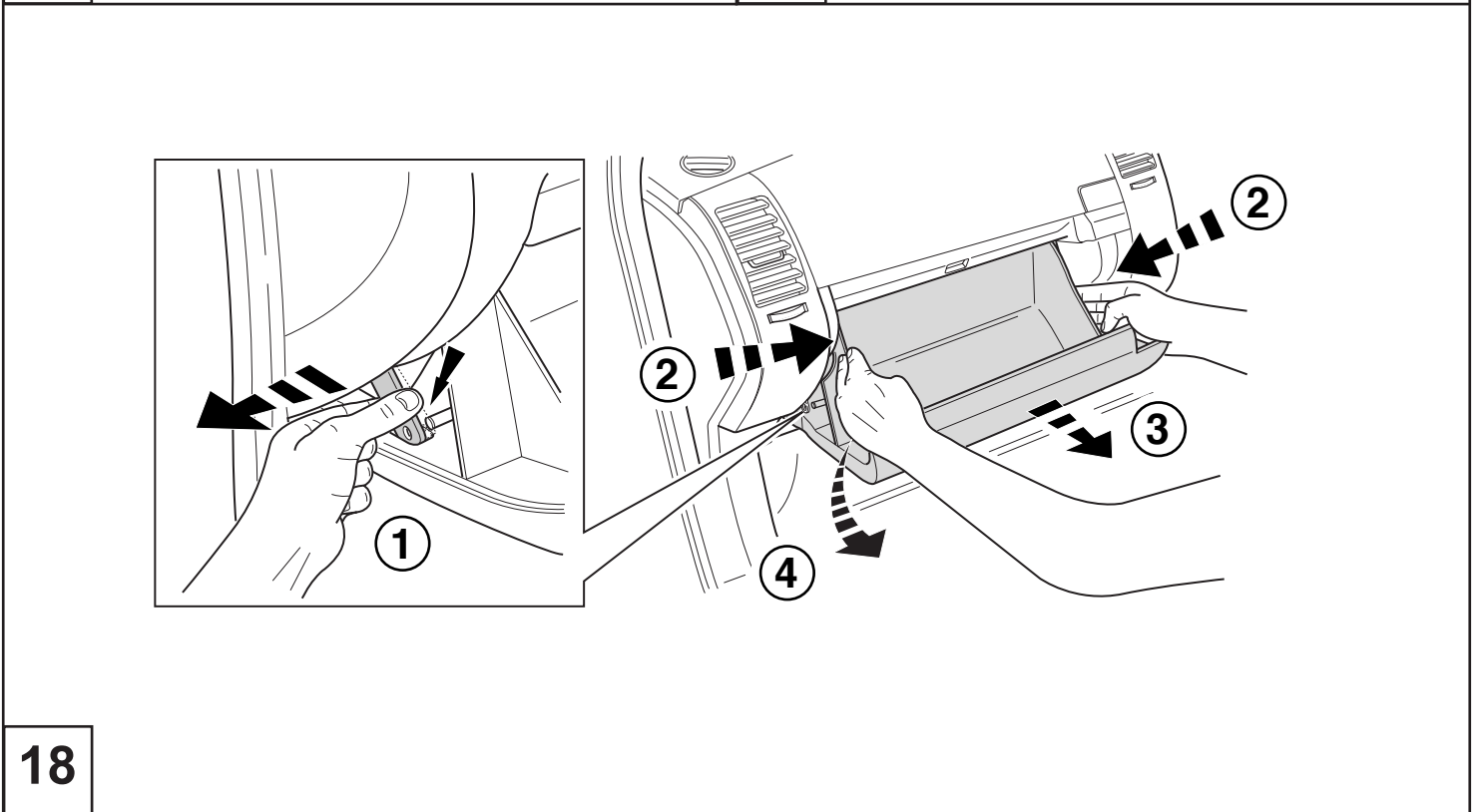

18

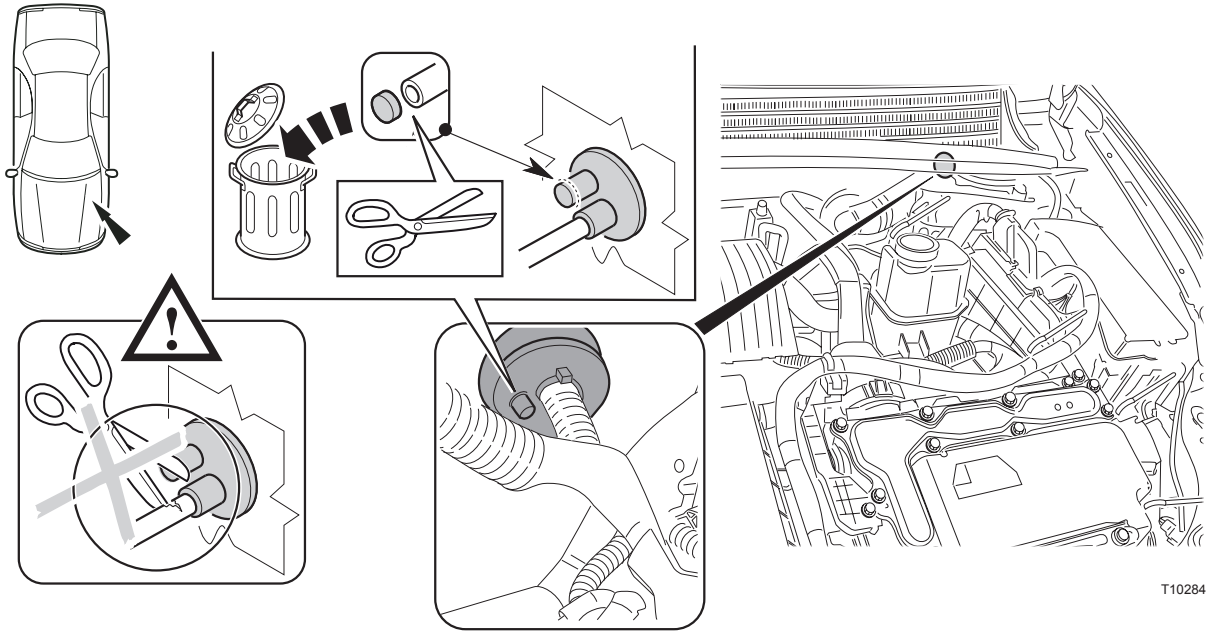

T10284

19

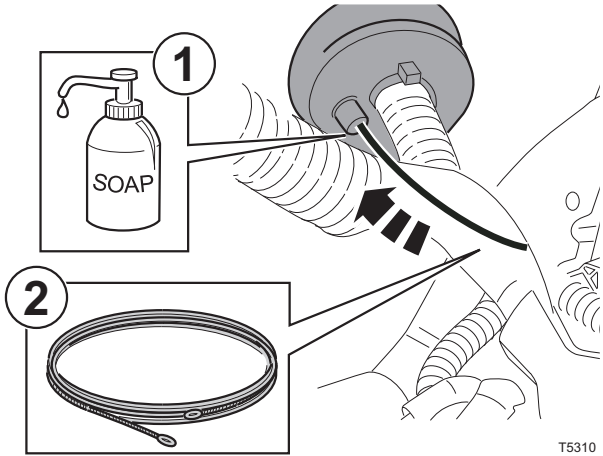

T5310

20

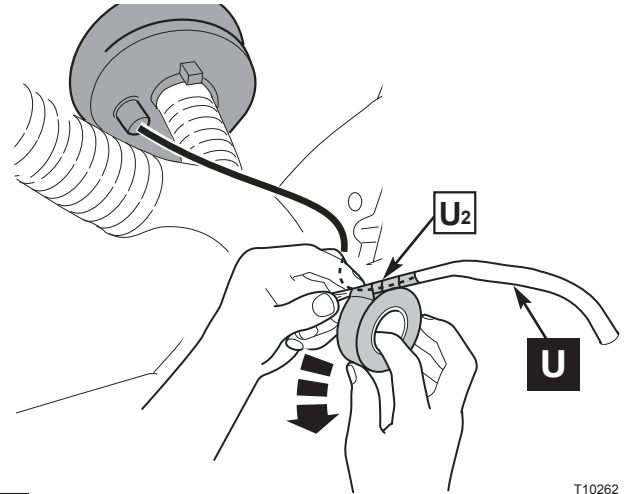

T10262

21

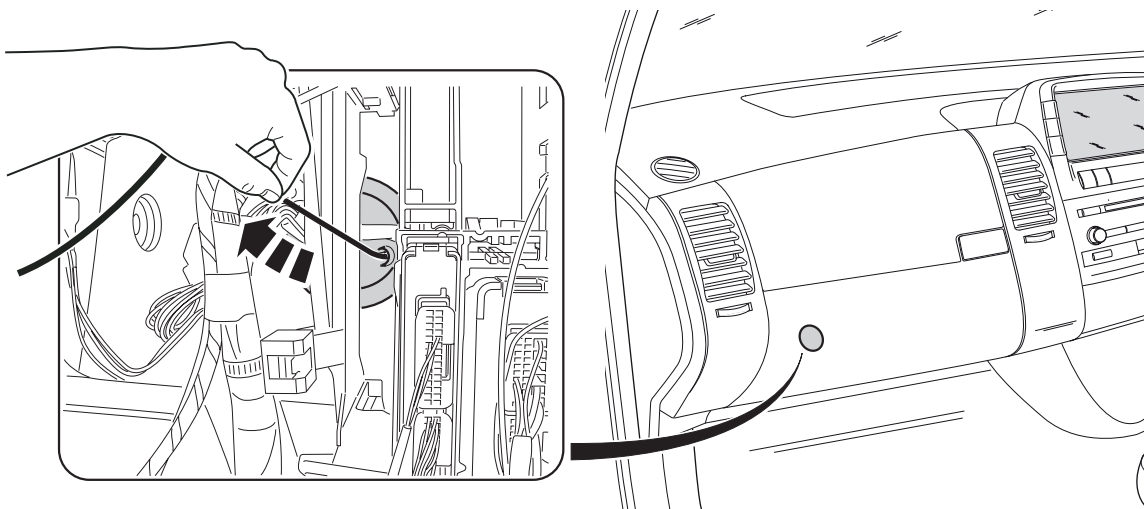

T10328

22

23

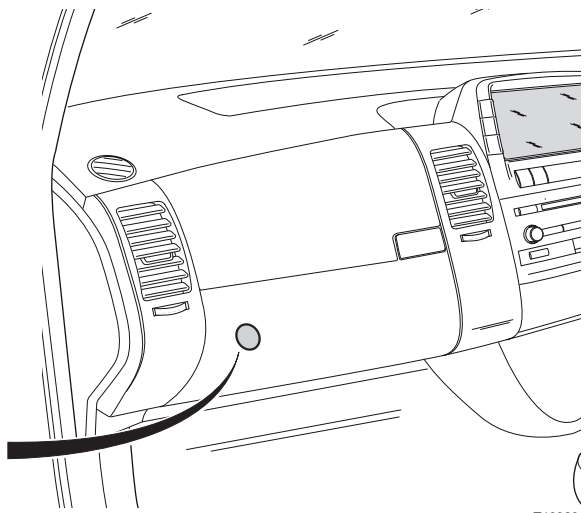
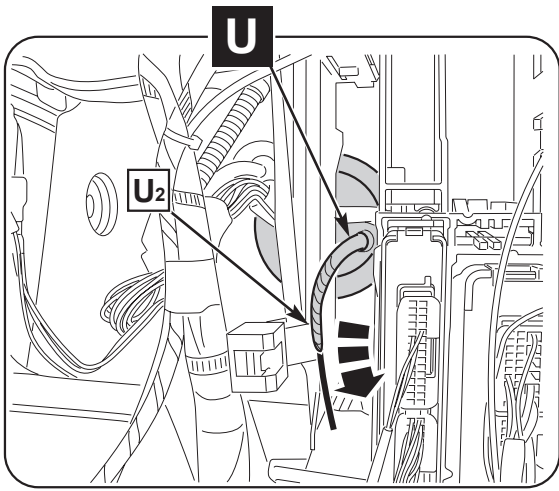

T10329

24

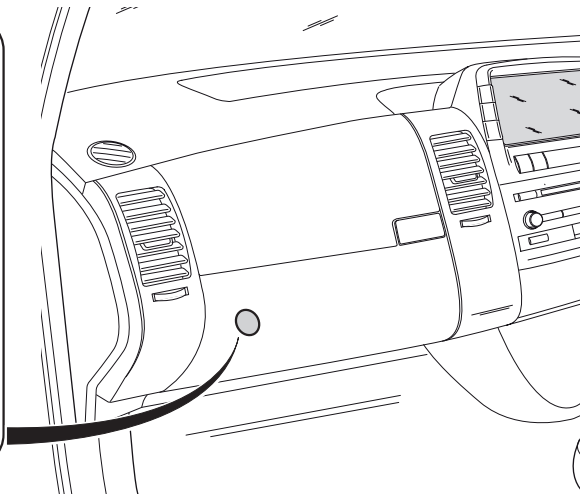
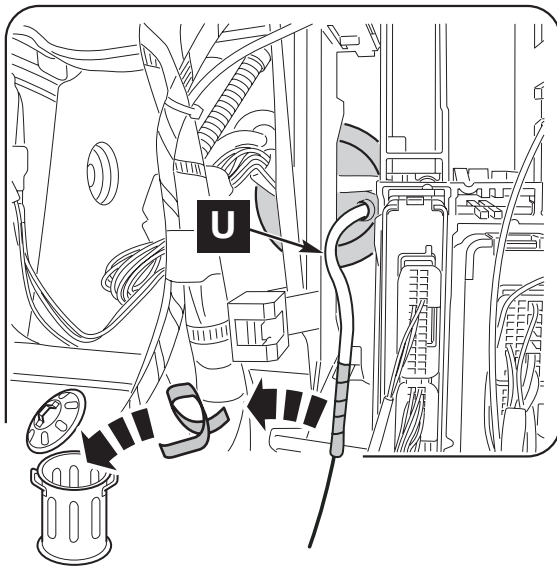

T10330

25

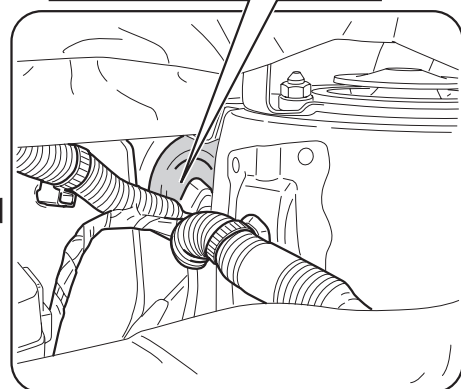
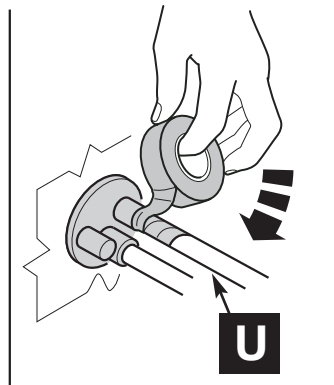
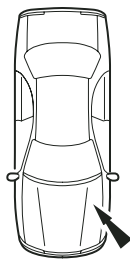
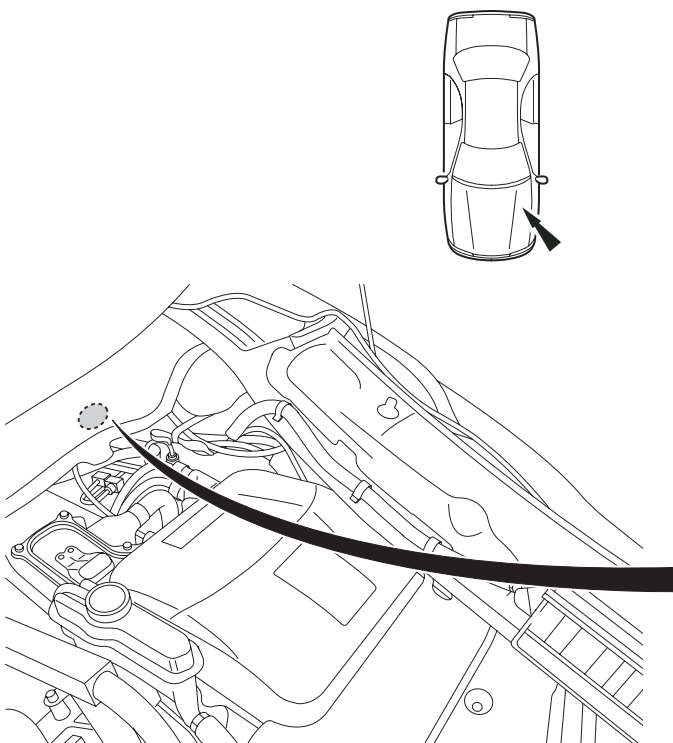

T10331

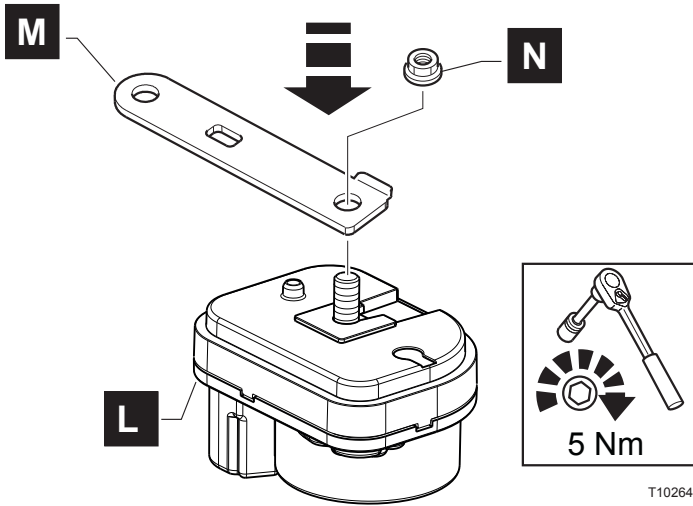

26

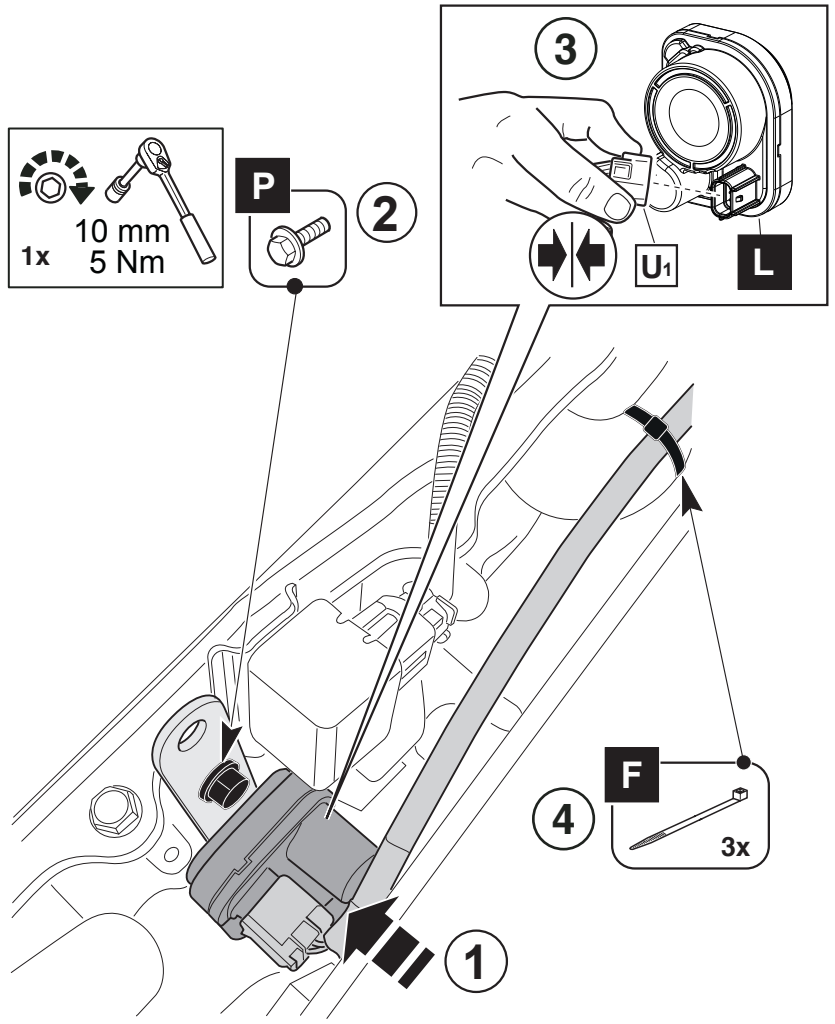
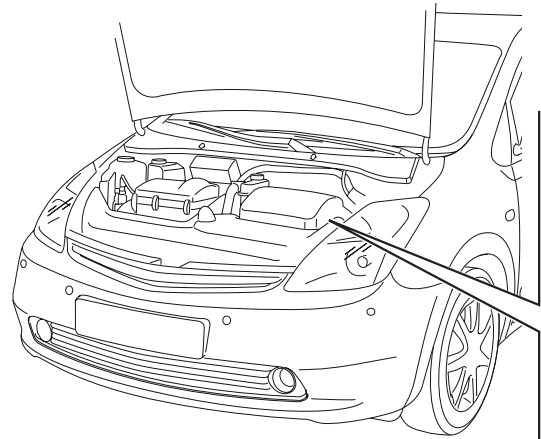

27

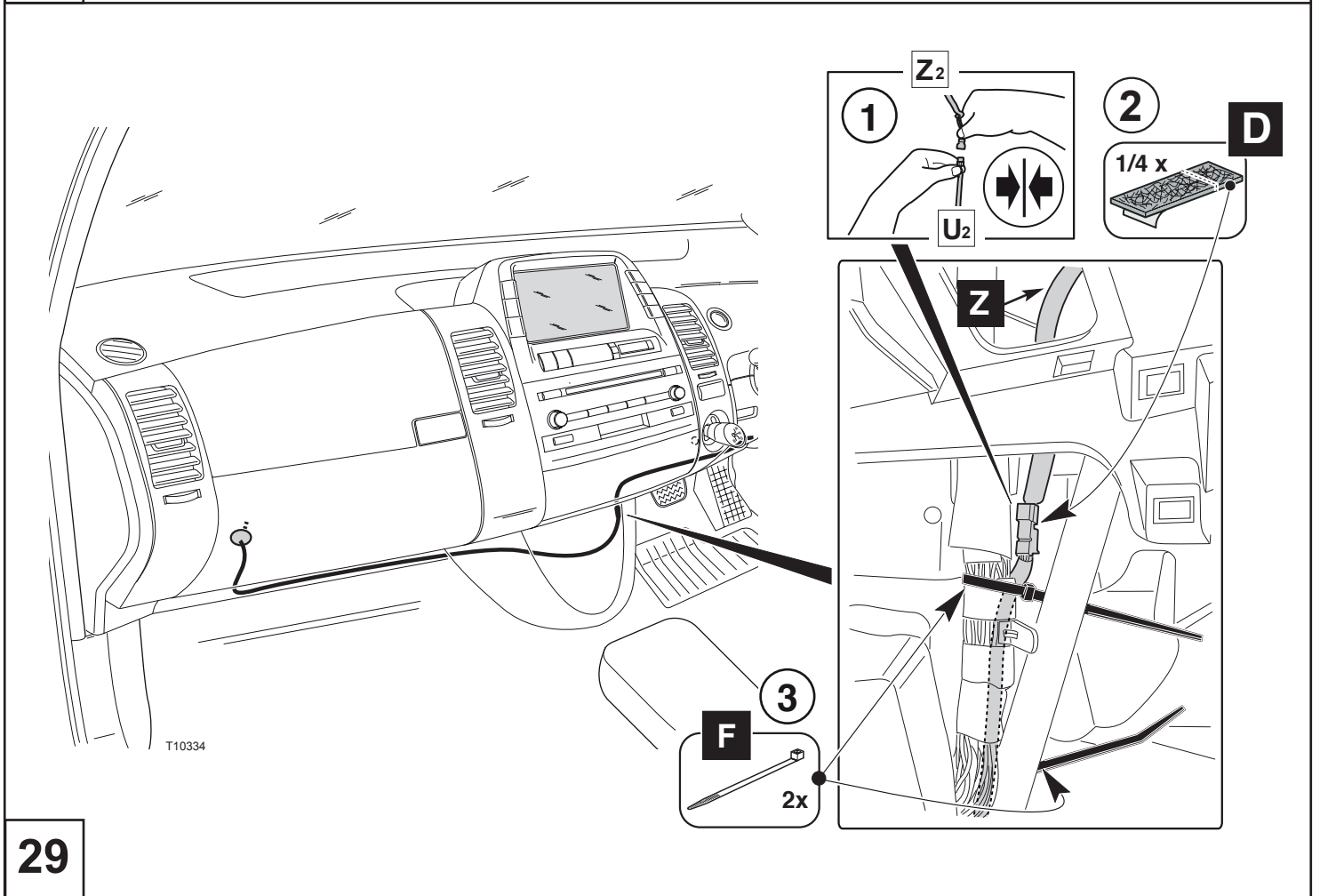
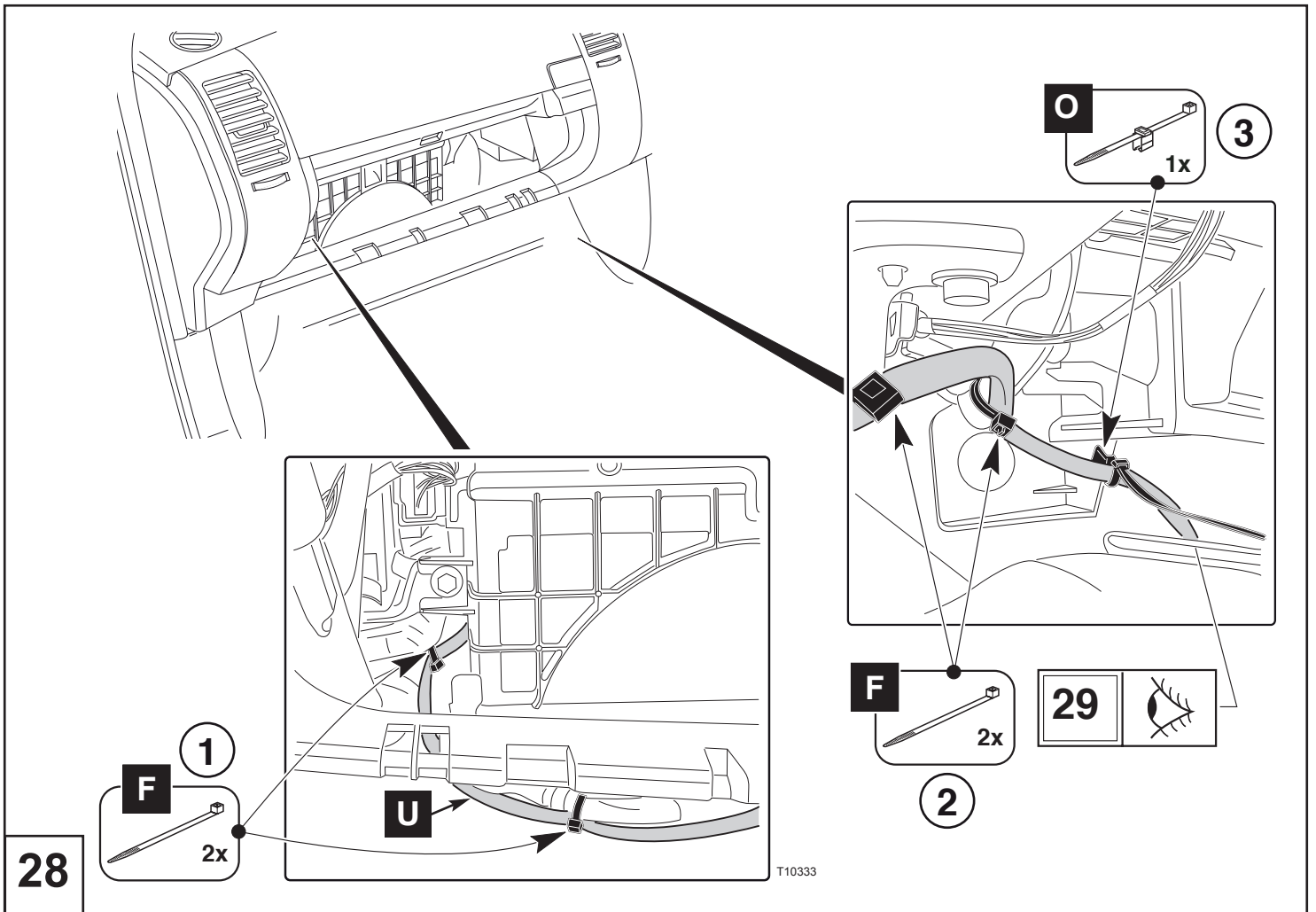

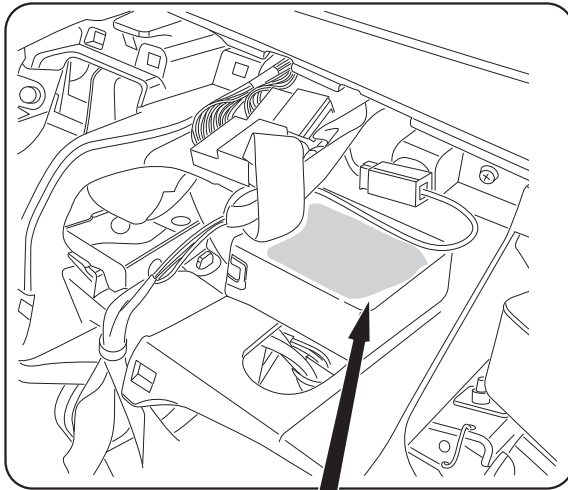

T10335

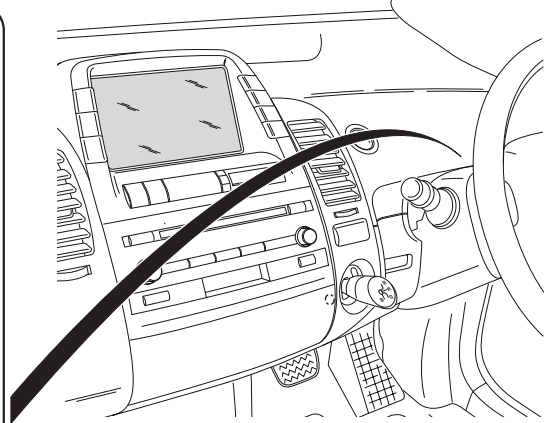

B



32

30

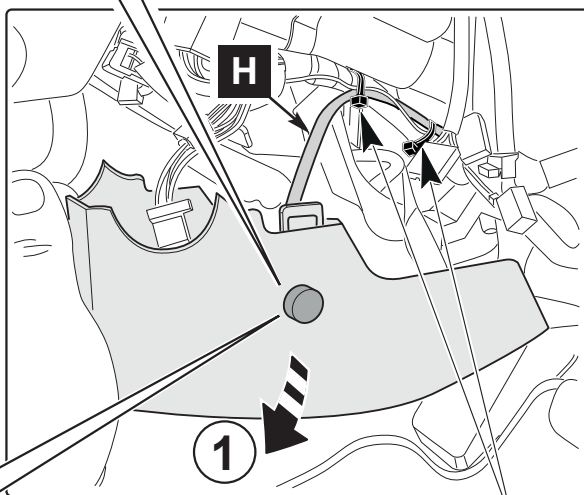
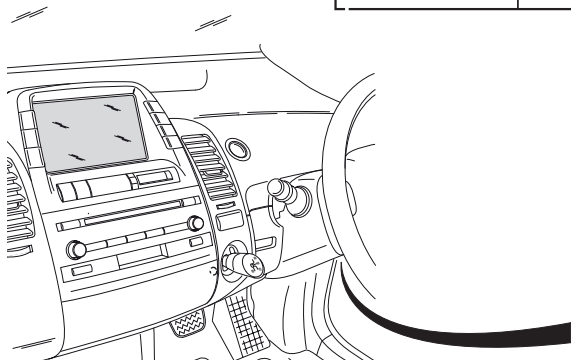
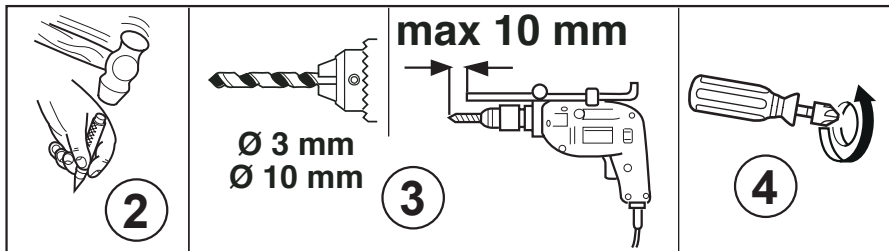

T10336

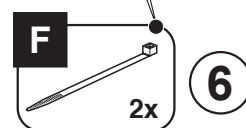
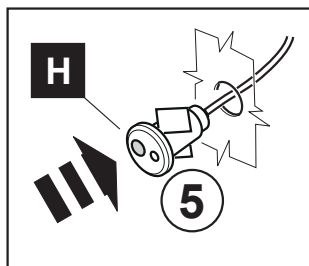

31

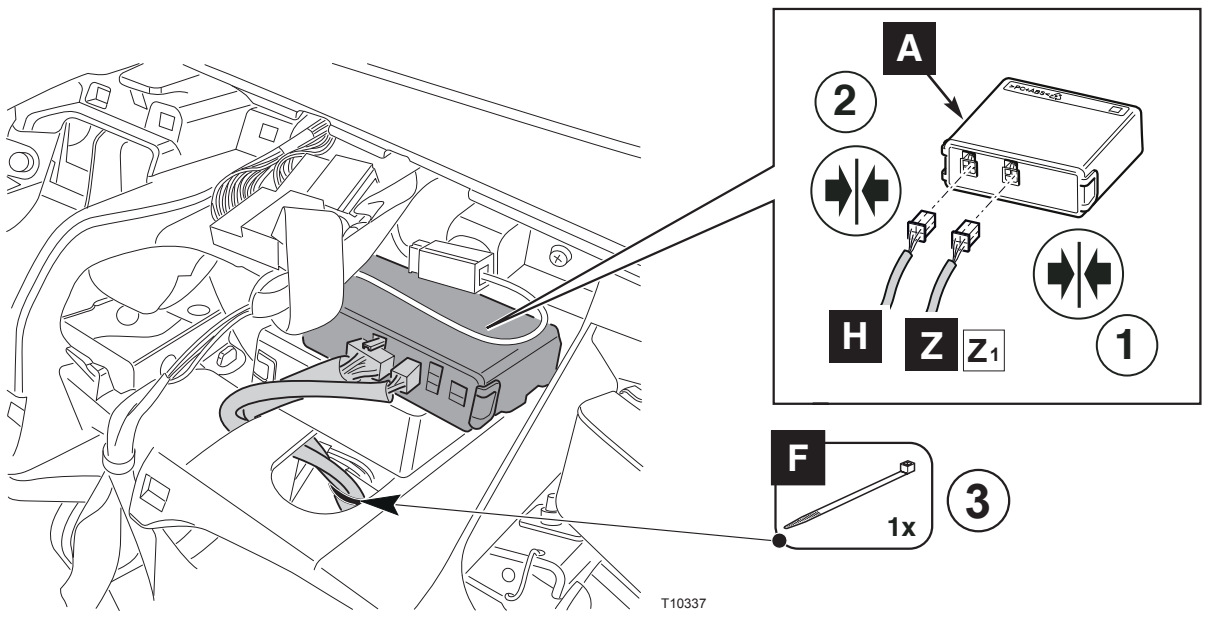

32

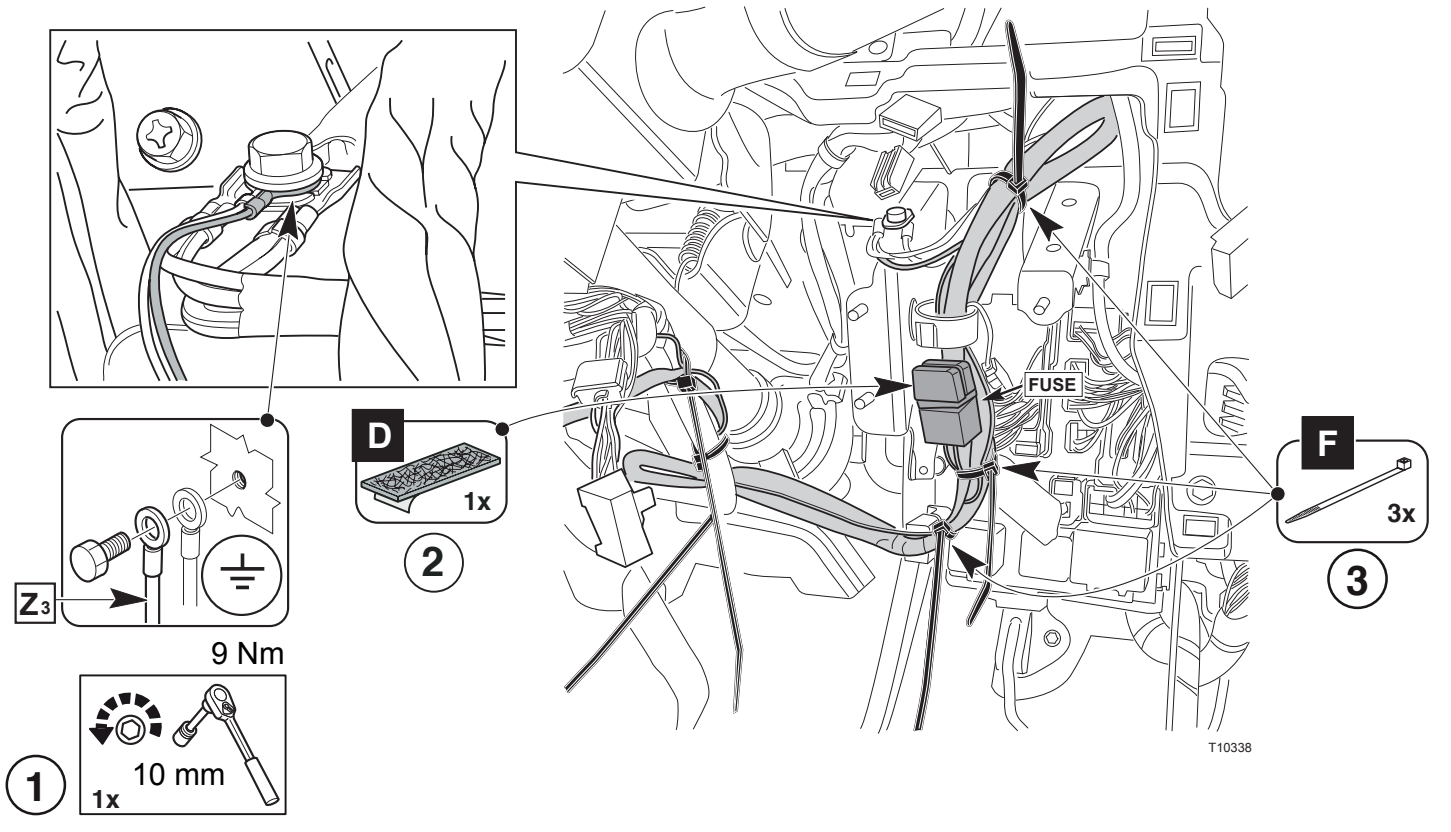

33

HORN

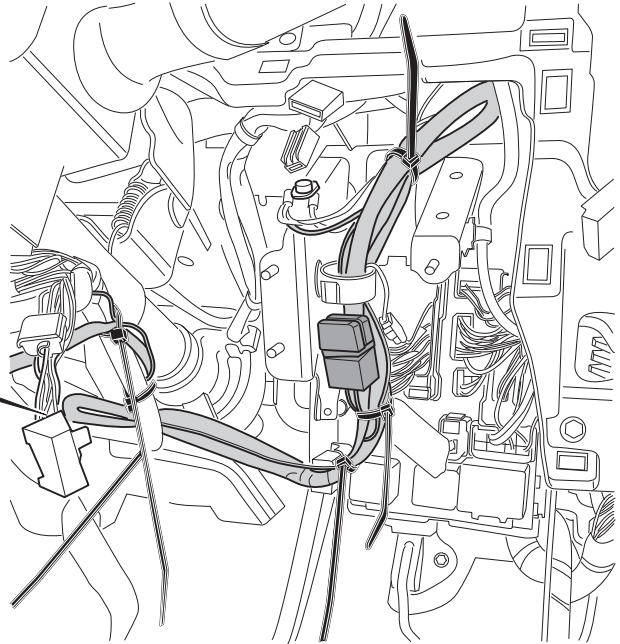
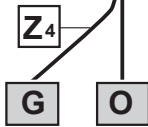
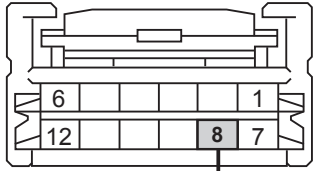
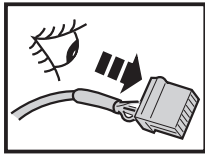

T10292



TOYOTA TECHNICAL DRAWING



37

34

B+

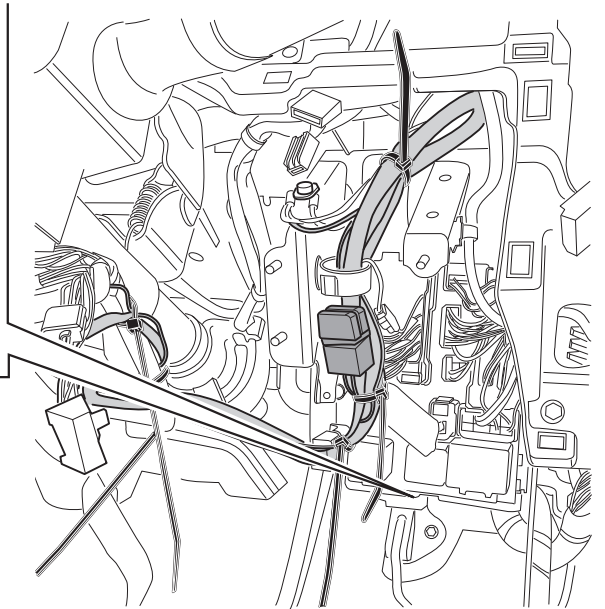
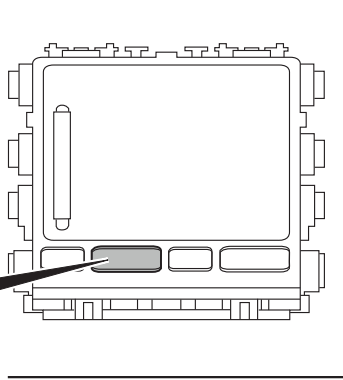
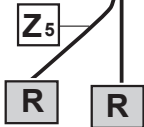
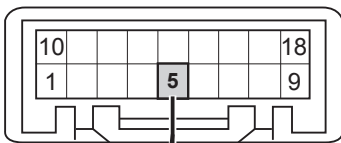
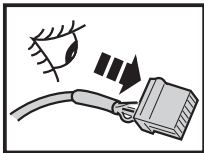

T10340



TOYOTA TECHNICAL DRAWING



37

35

+15 

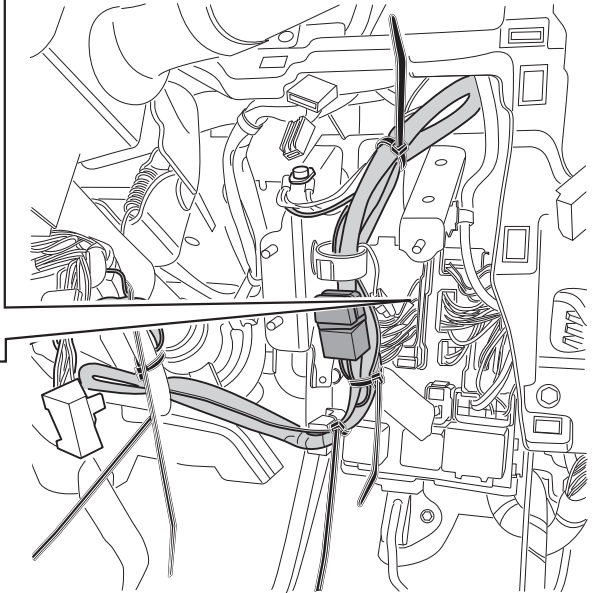
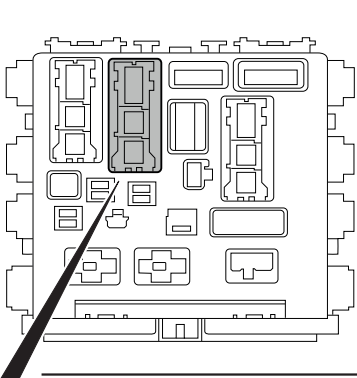
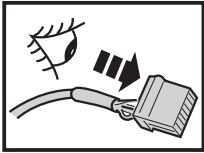

 **TOYOTA TECHNICAL DRAWING**

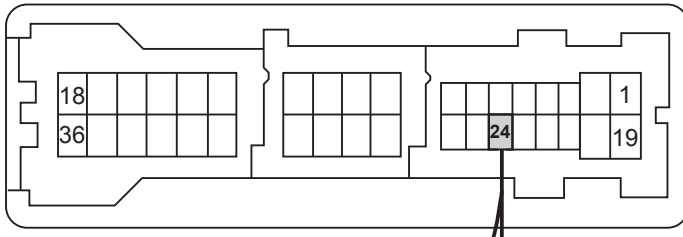

Z₆
G/R **B**

 **37**

36

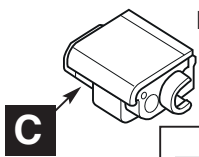

PW501-00583

Only applicable for Copper wires

558	Wire range (mm ²)		Wire insulation diameter (mm)
	Min.	Max.	
OE wire	0,35	1,5	3
Accessory wire	0,35	1,5	3

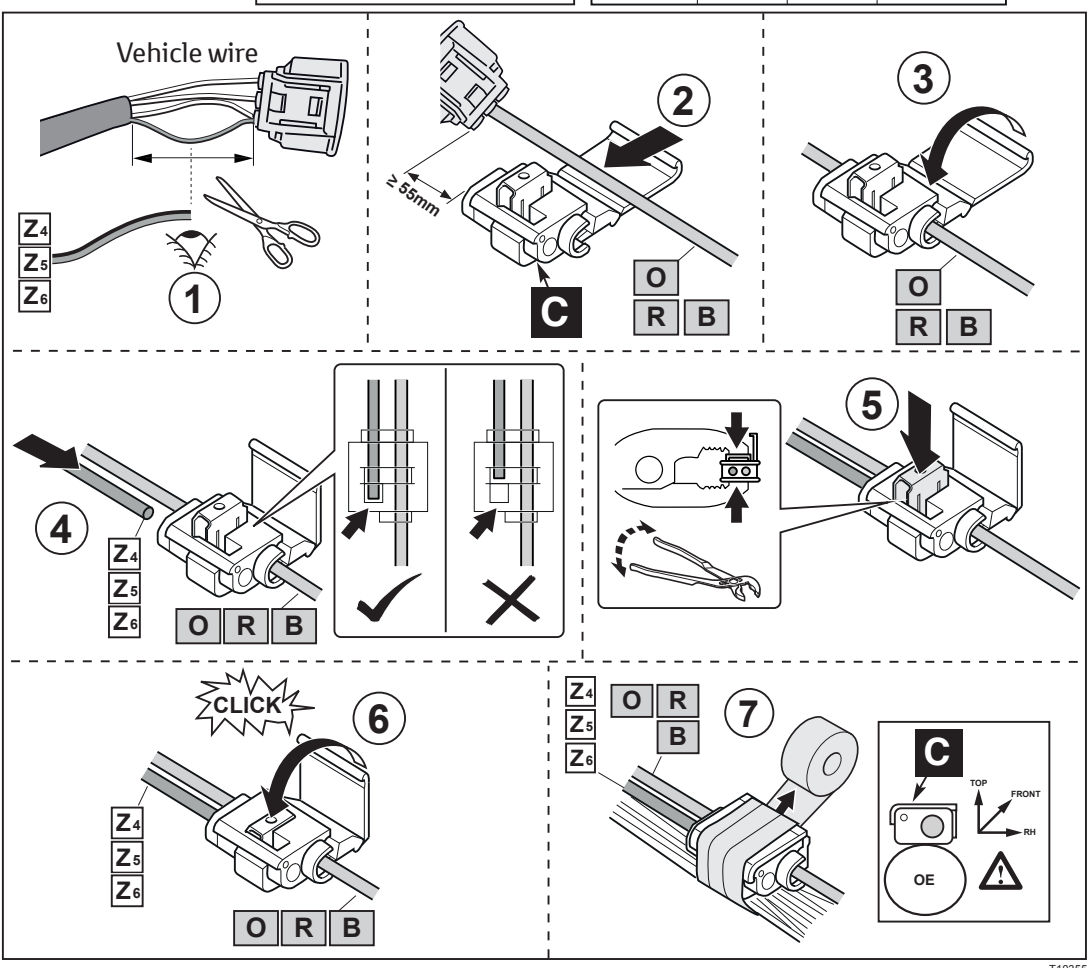
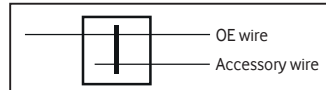

37

T10355

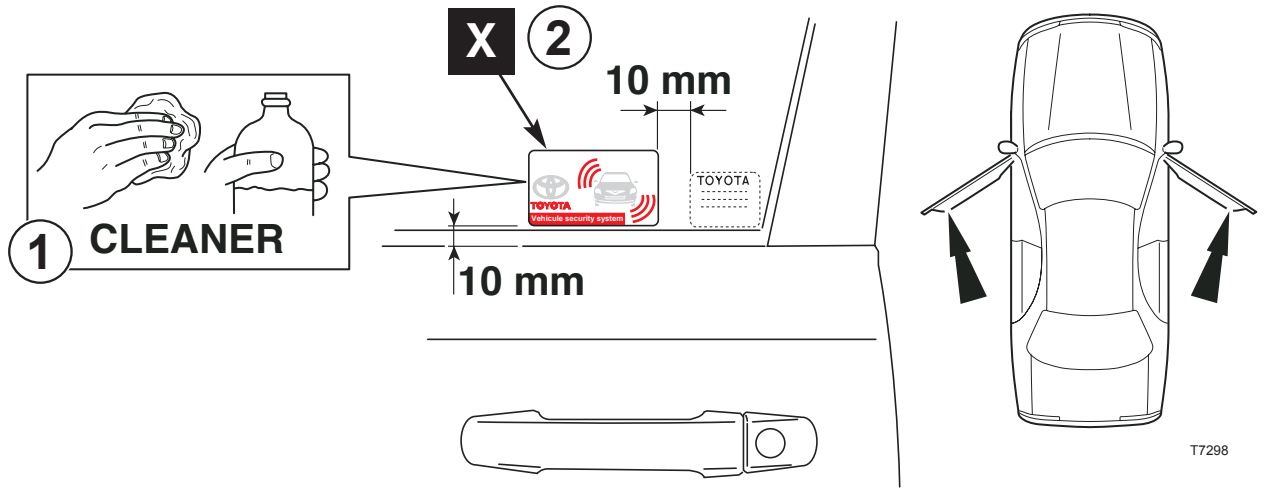

38

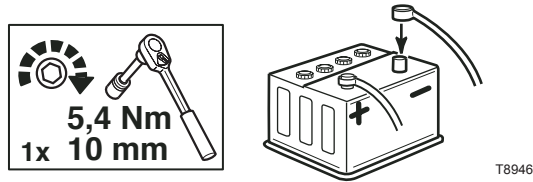

39

CHECK SHEET

Model / Year

Prius RHD 2003

Tilt Sensor

VIN n°

