



TOYOTA

ALWAYS A
BETTER WAY

Yaris

Airvent contours (painted)

Installation Instructions

Model year: 2017/03
Vehicle code: **P13**-C****W
Part number: PW277- 0D100-**

Manual reference number: AIM 004 020-2

Revision record





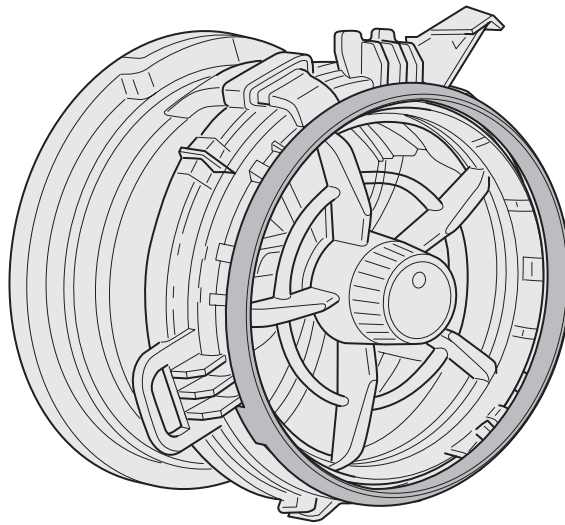













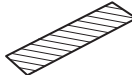

Rev. No.	Date	Page	Picture	Update	New	Deleted steps
1	25-03-17	2, 3, 4	A, 2, 5	X		3, 4
2	09-03-18	1, 2		Part Number		

PW277-0D100-**



A

2x

 = 	 = 	 = 	  = 	 = 
 = 	 = 	 = 	  = 	 =  START

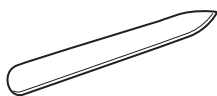

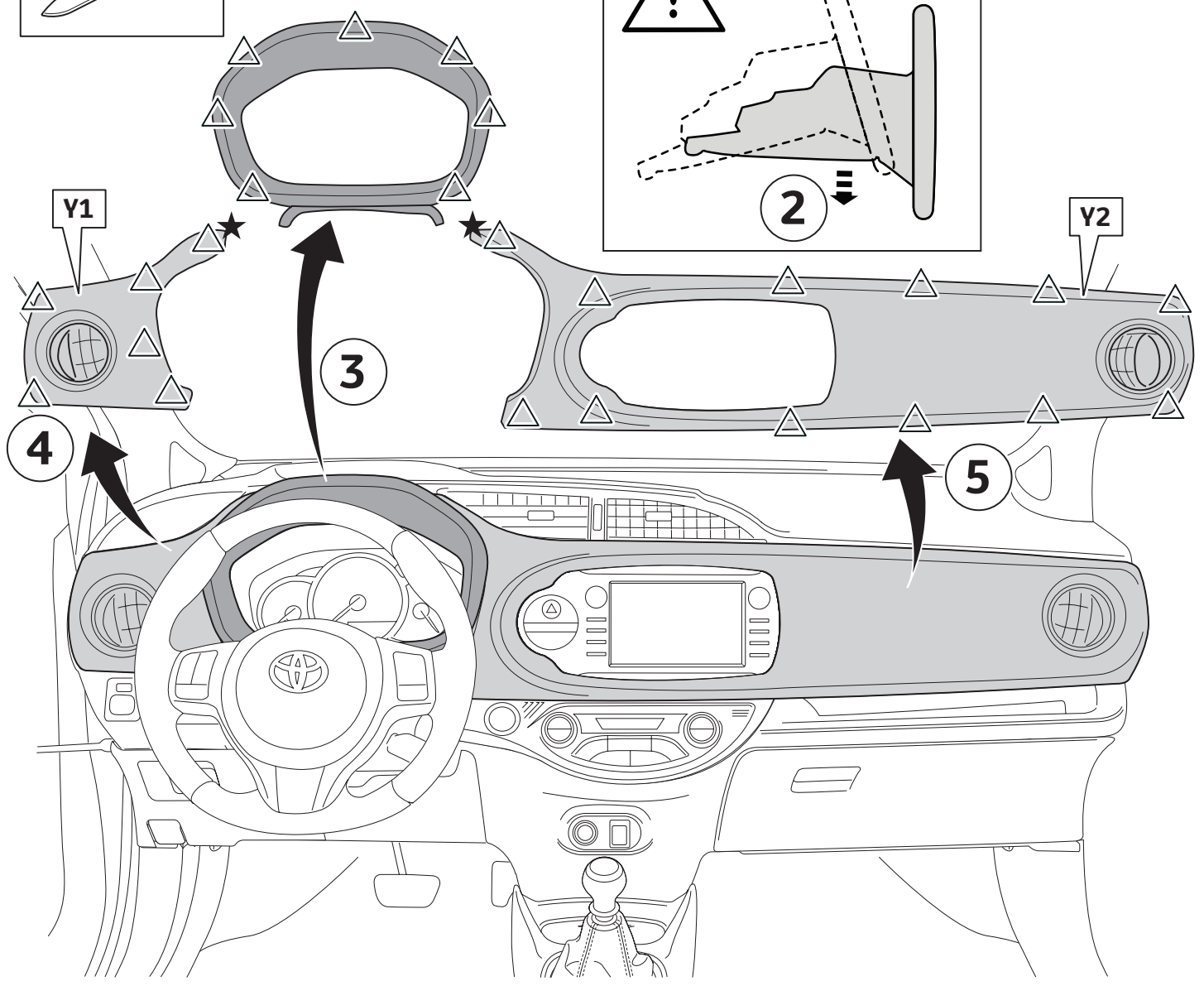
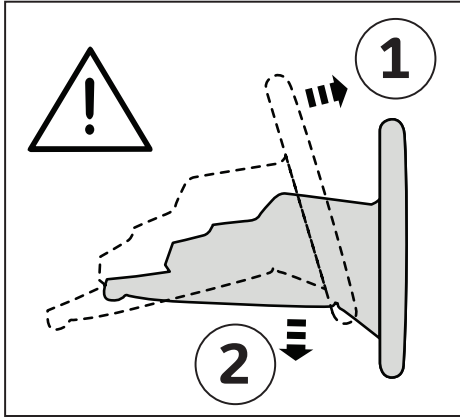
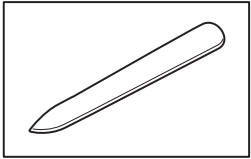

1

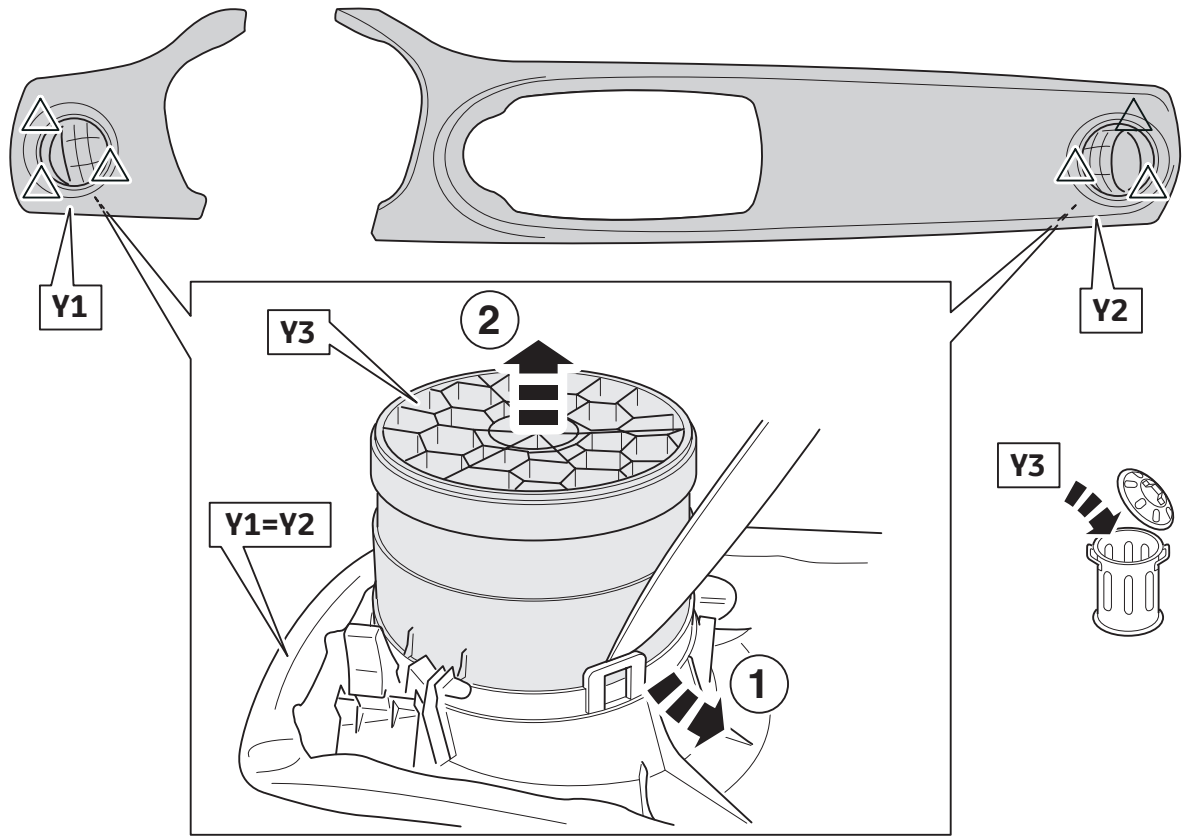

2

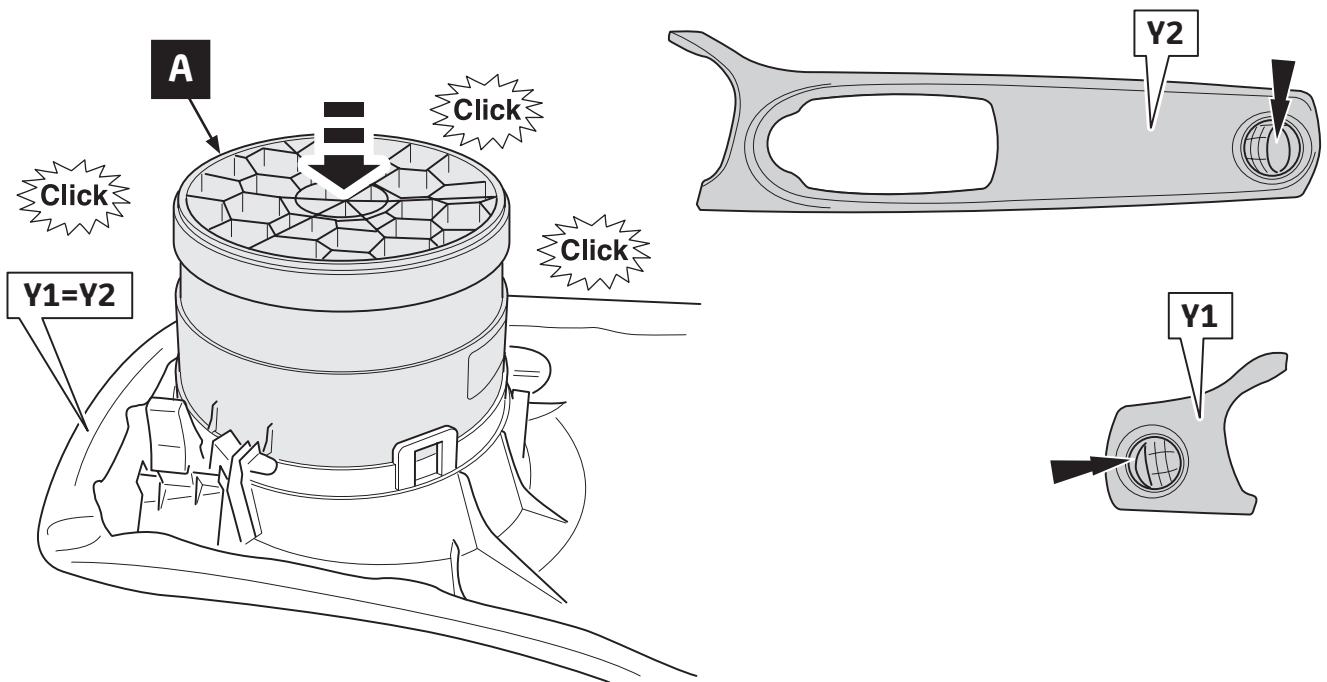

3

CHECK SHEET



TOYOTA

ALWAYS A
BETTER WAY



Model / Year

**Yaris
2017/03**

Airvent contours (painted)

VIN n°

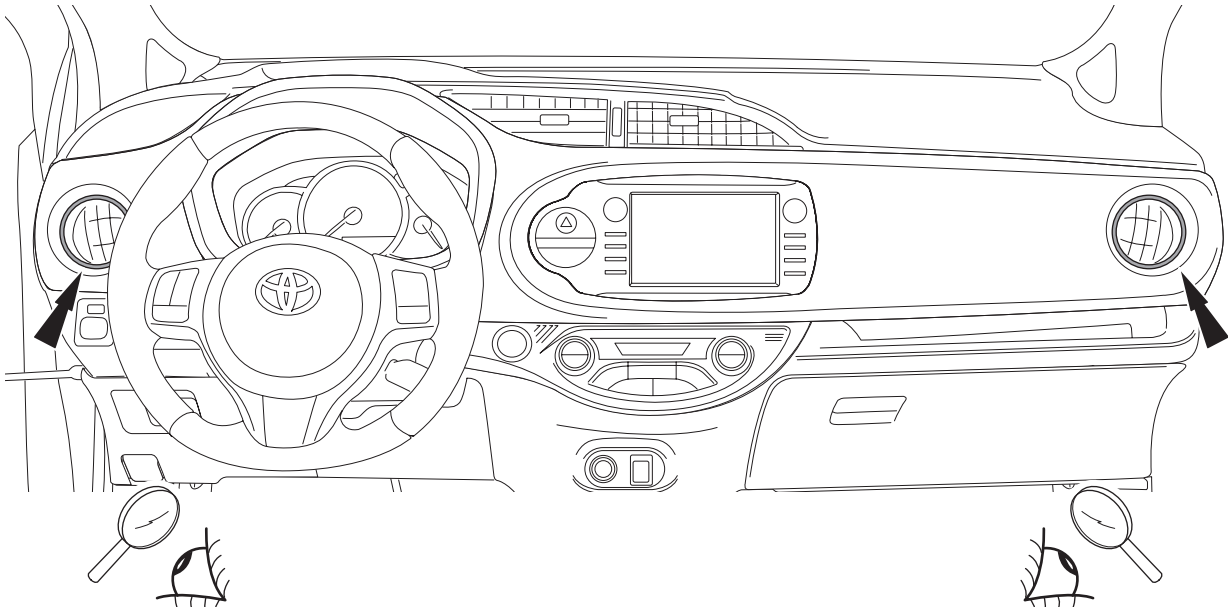
 **P/N = OK**

= OK = OK

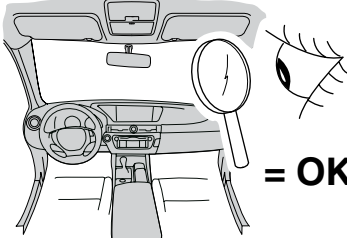

= OK

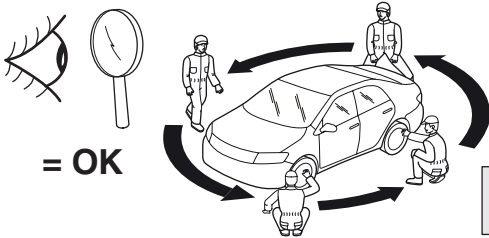

= OK

Installation Date:
... / ... / ...

Technician Name & Signature:

Stamp:



TOYOTA