



TOYOTA

ALWAYS A
BETTER WAY

Yaris

Rear bumper protection plate, plastic

Installation Instructions

Model year: As from 2020/06

Vehicle code: **P*11*-*H***W

Part number: PW178-0D100

Manual reference number: AIM 004 441-0

Revision record

Rev. No.	Date	Page	Step	Remarks

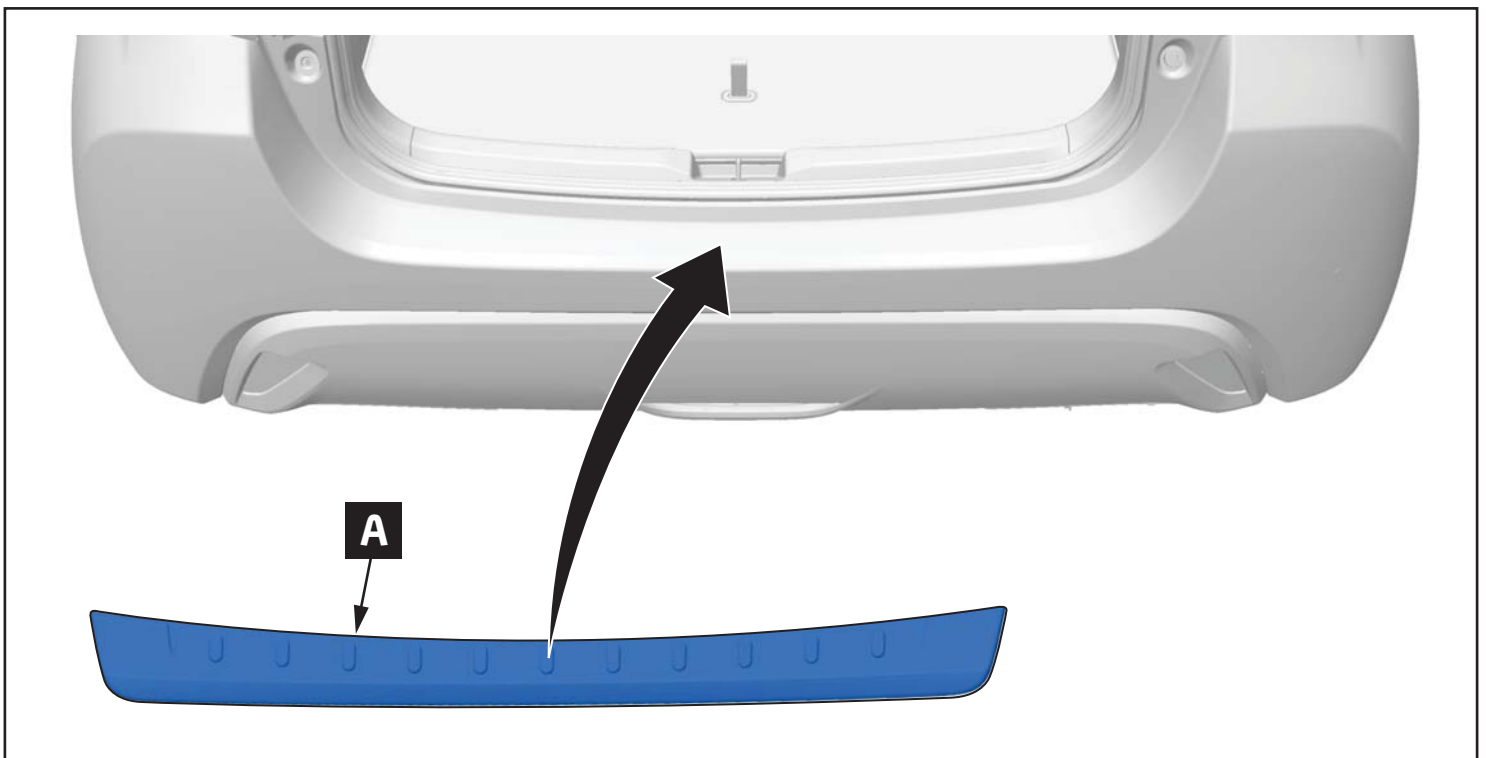

<p>AIM 003-516-*</p>		

INFO



Material Safety Data Sheet



Technical Data Sheet

20°C - 40°C

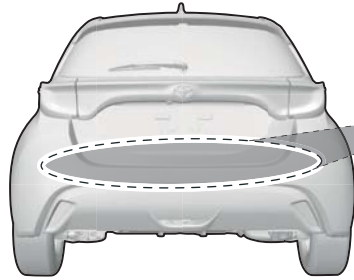

20°C - 40°C

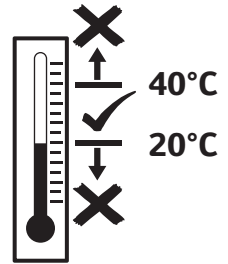
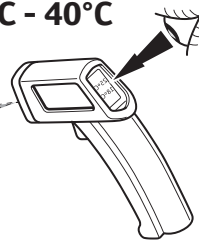

20°C - 40°C

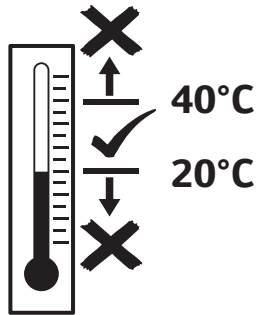
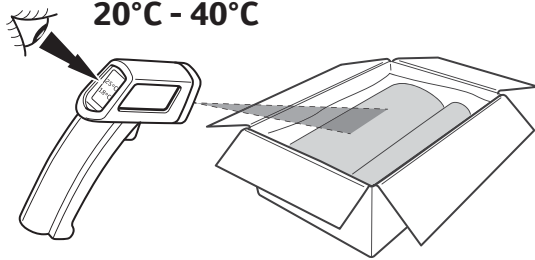

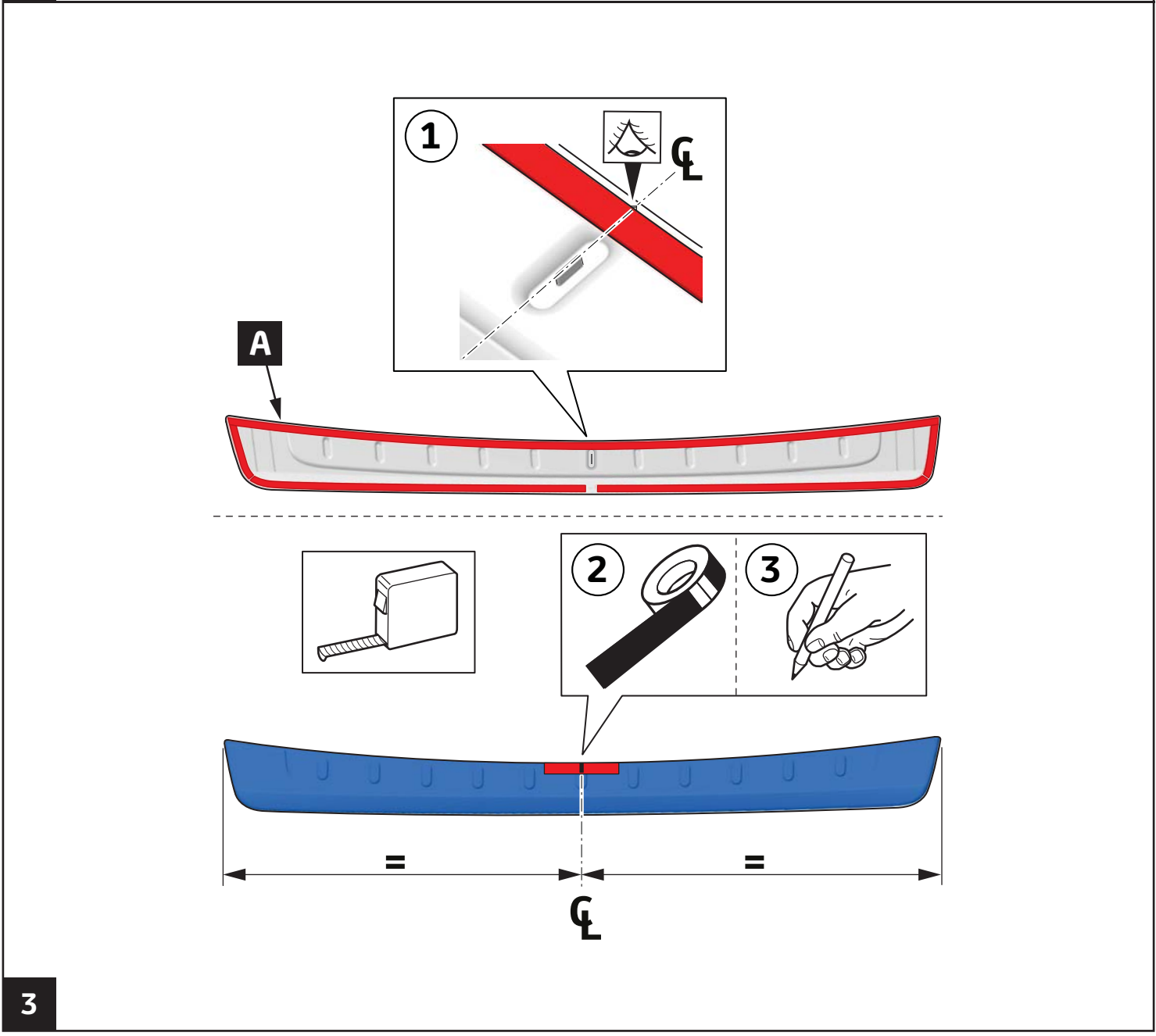
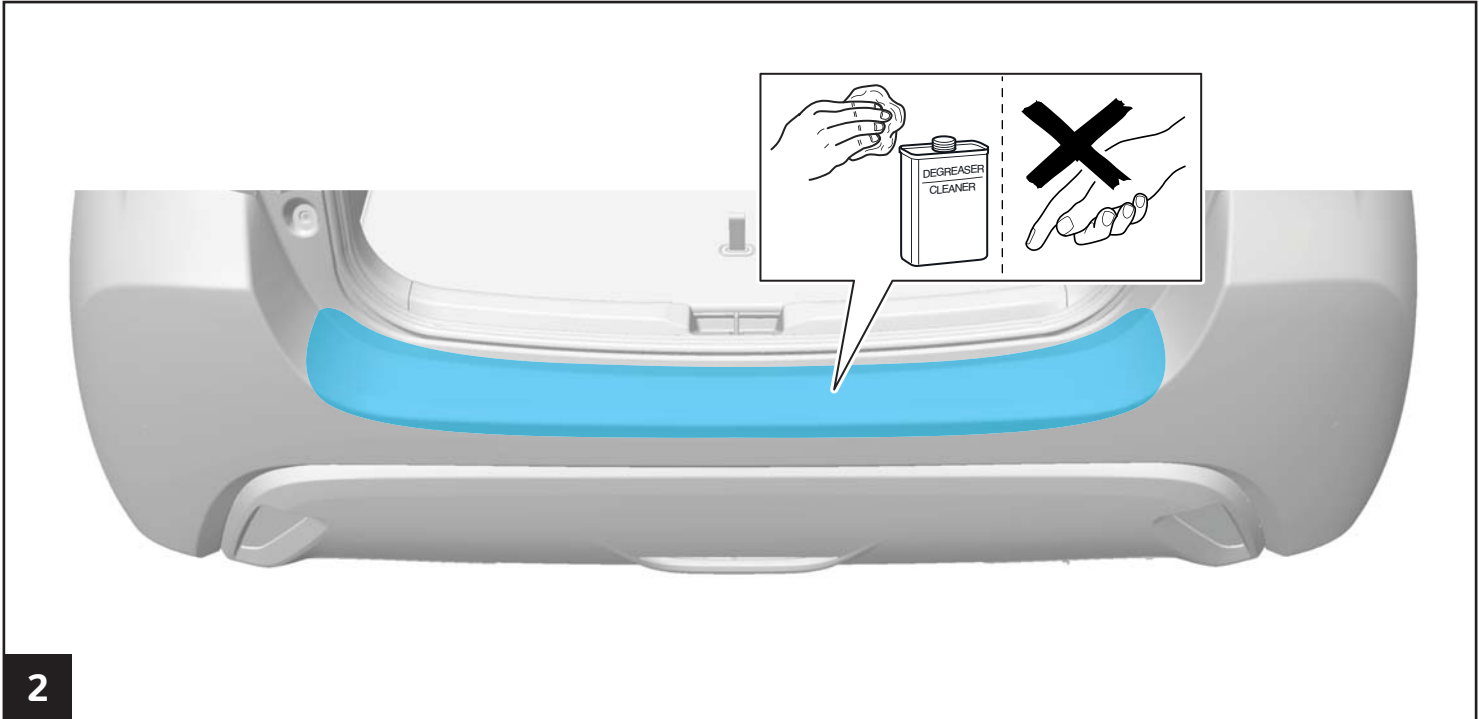

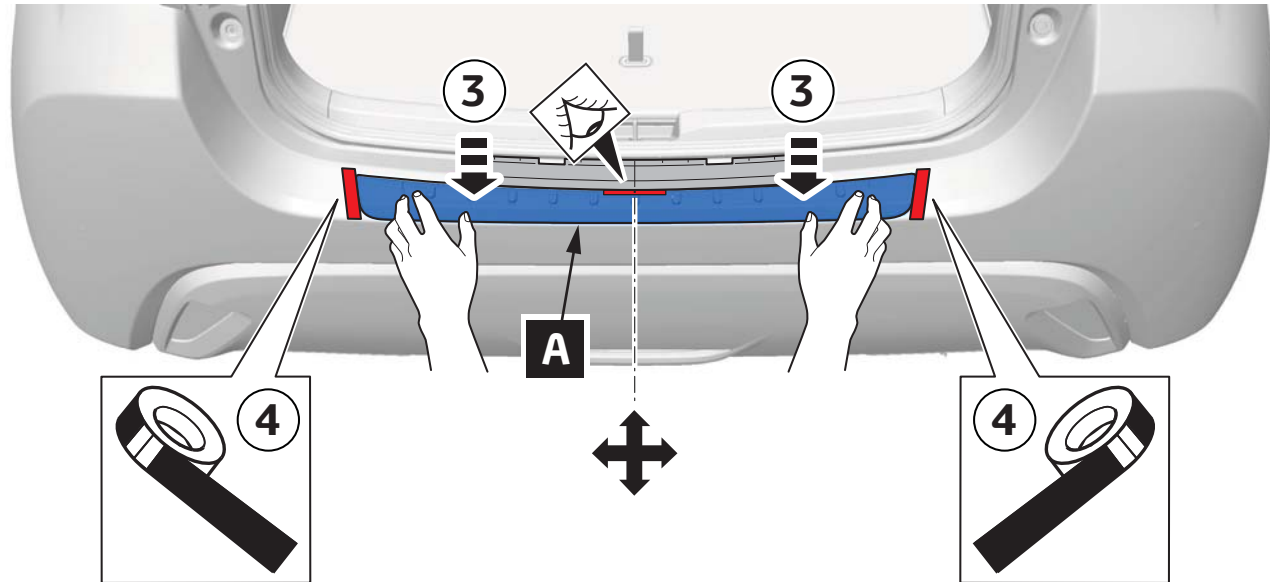
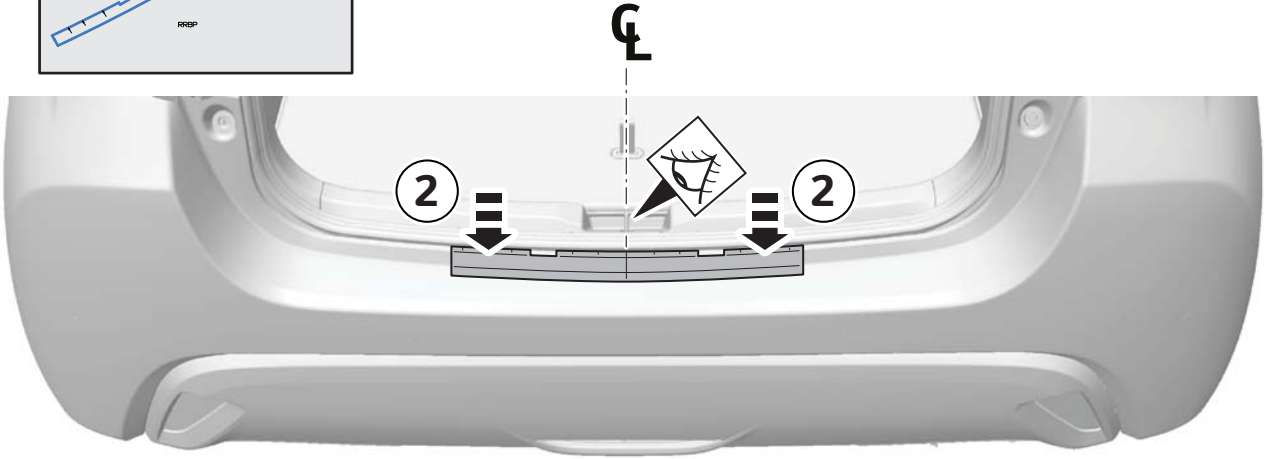
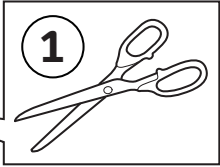
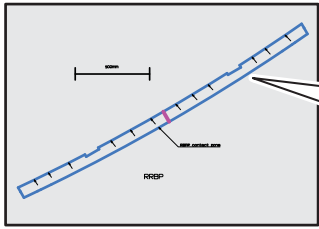

4

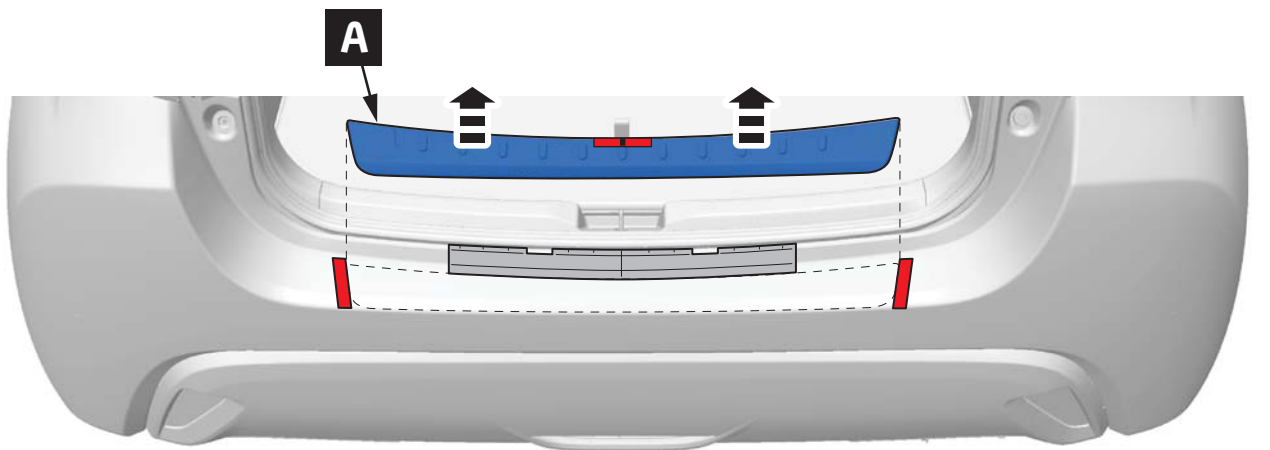

5

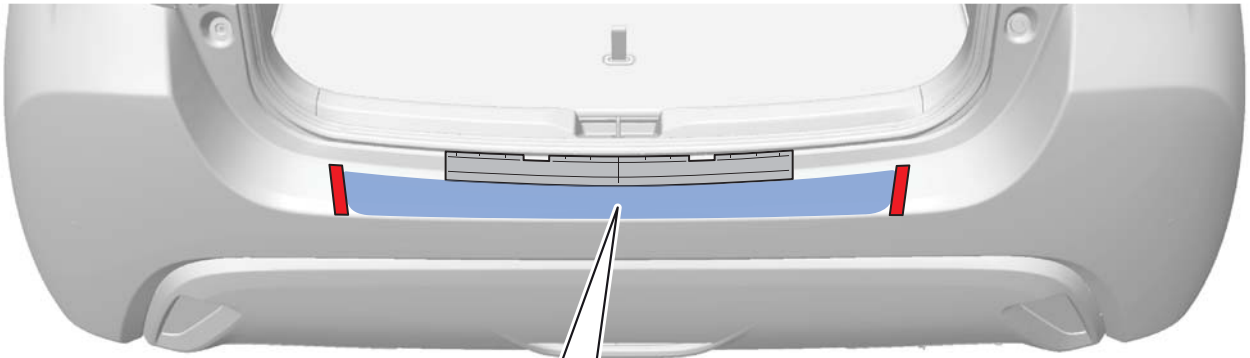

<p>1</p>	<p>< 20°C → 2</p> <p>20°C - 40°C → 7</p>	<p>2</p>
<p>3</p>	<p>20°C - 40°C → 7</p>	<p>INFO</p>

6

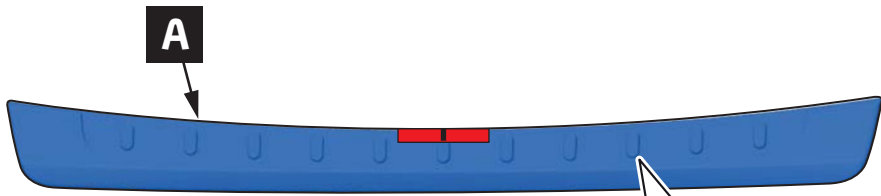

<p>1</p>	<p>< 20°C → 2</p> <p>20°C - 40°C → 8</p>	<p>2</p>
<p>3</p>	<p>20°C - 40°C → 8</p>	<p>INFO</p>

7

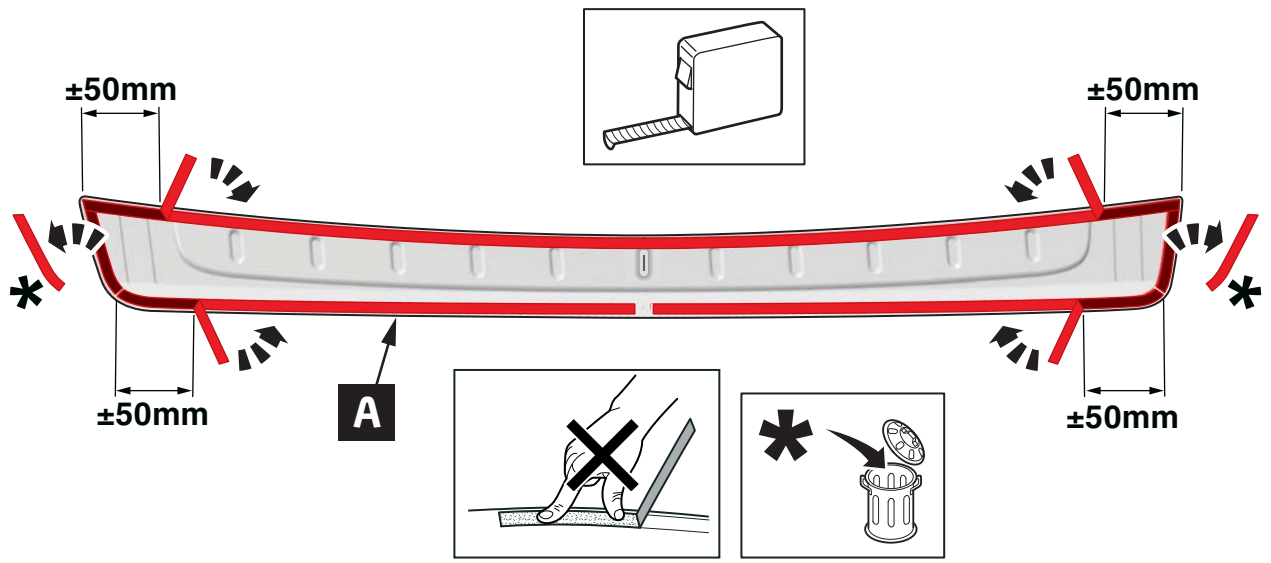

8

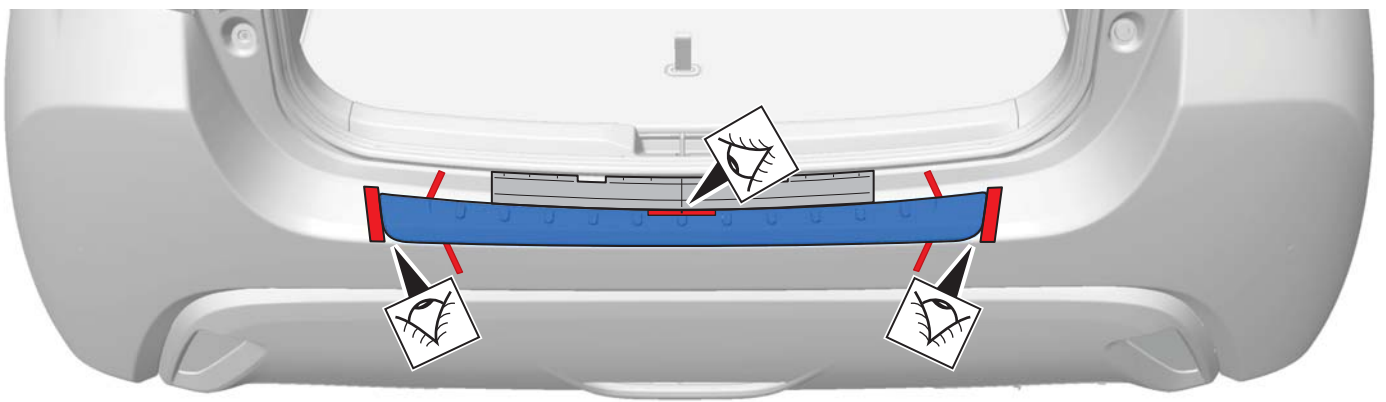
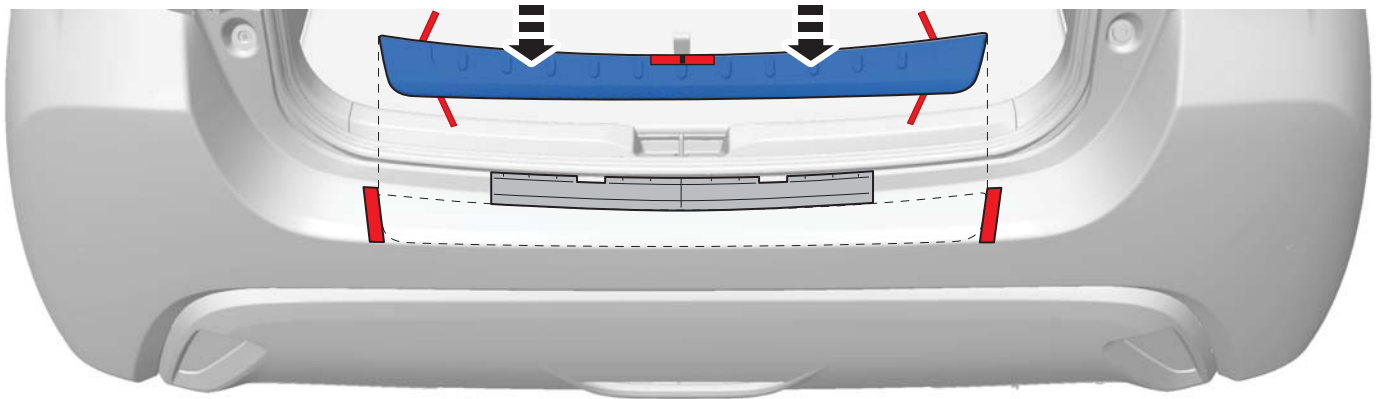

9

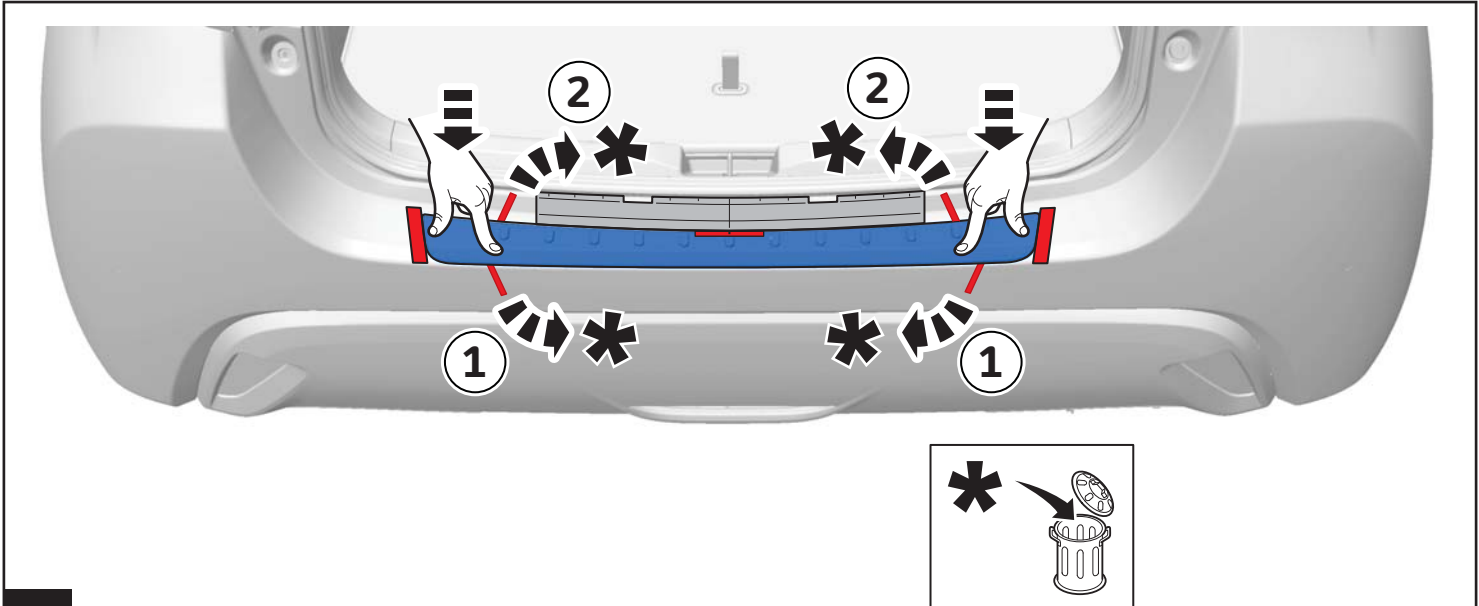

10

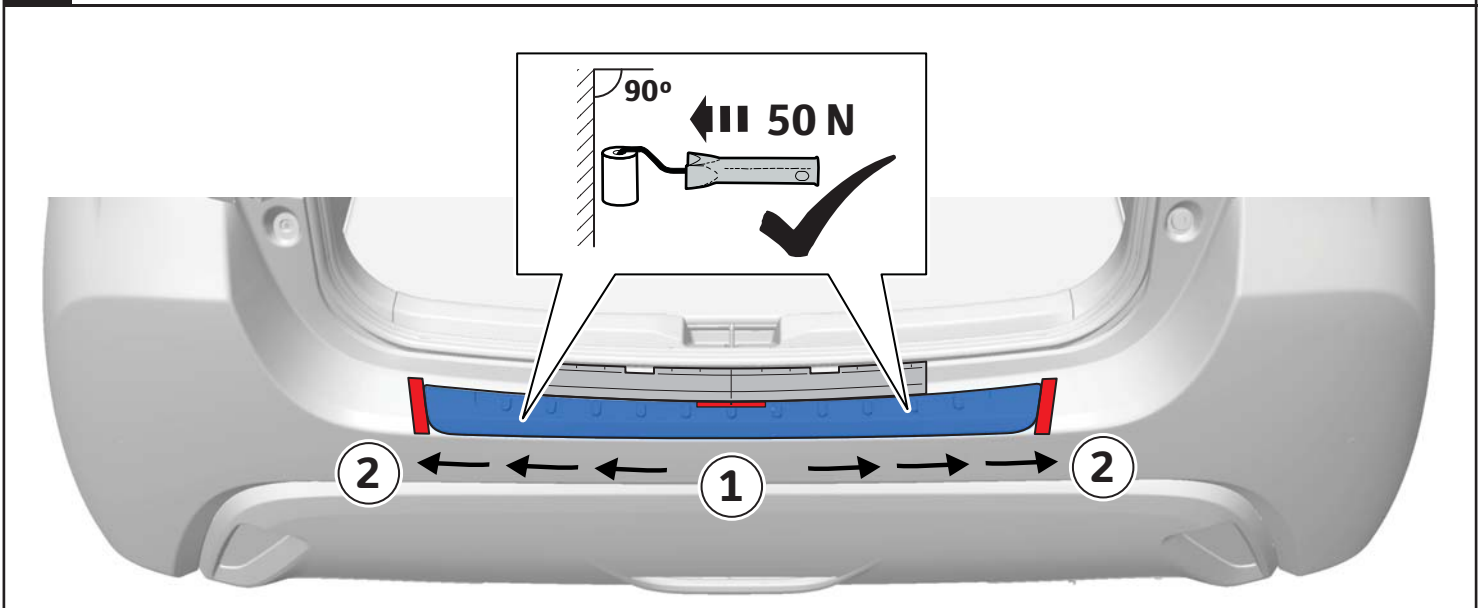

11

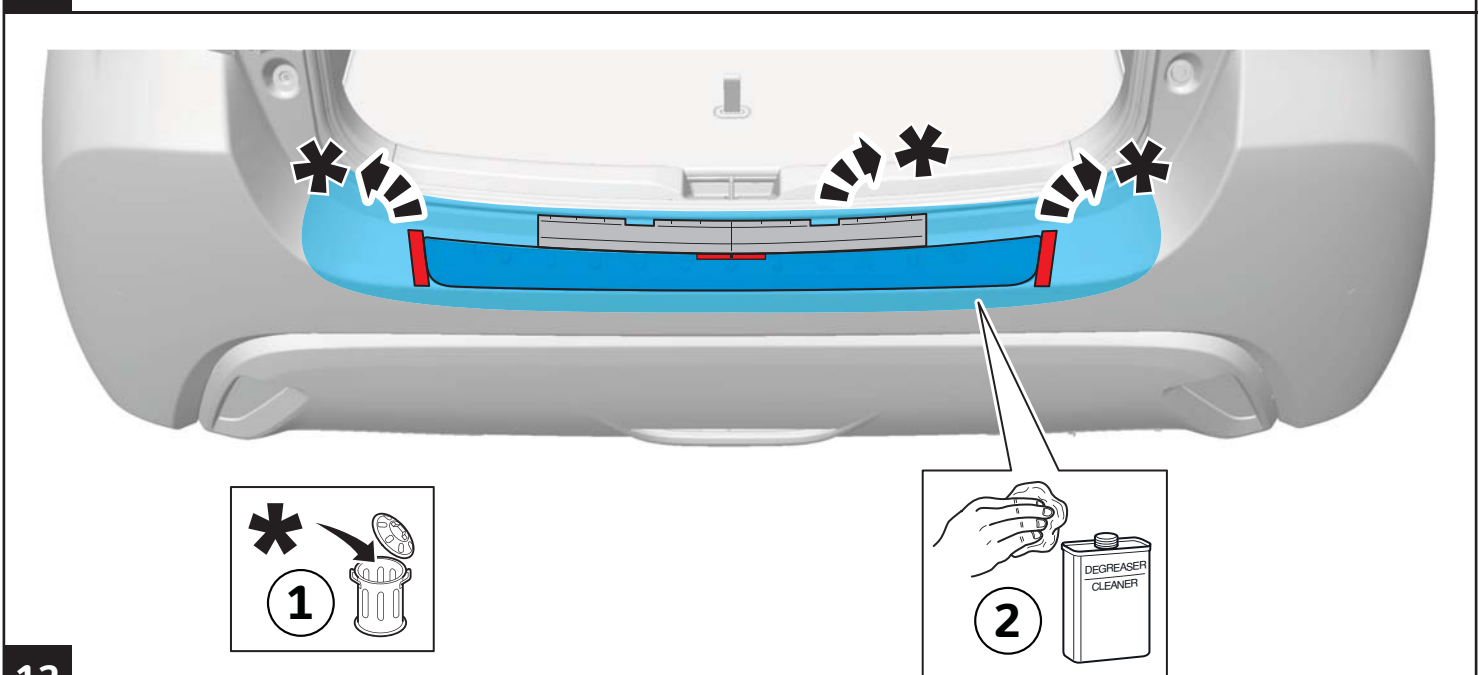

12

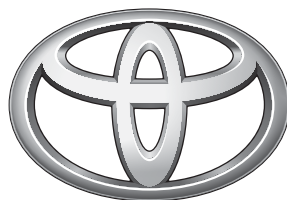
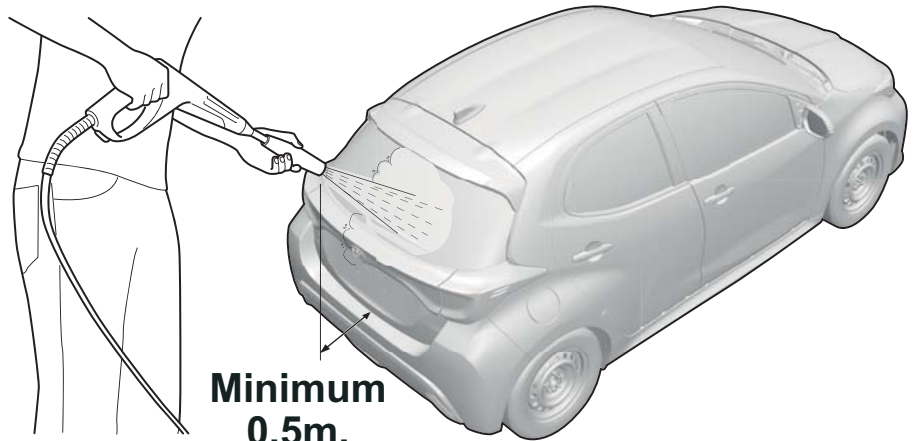
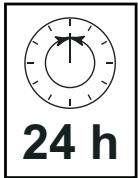
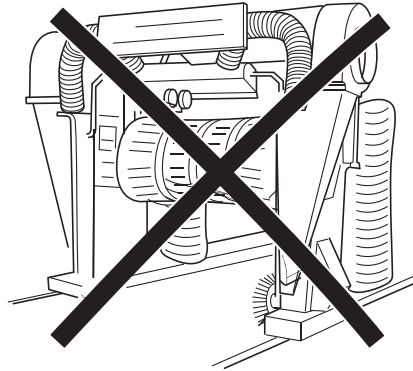
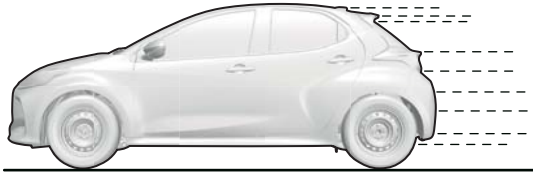
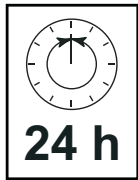

TOYOTA



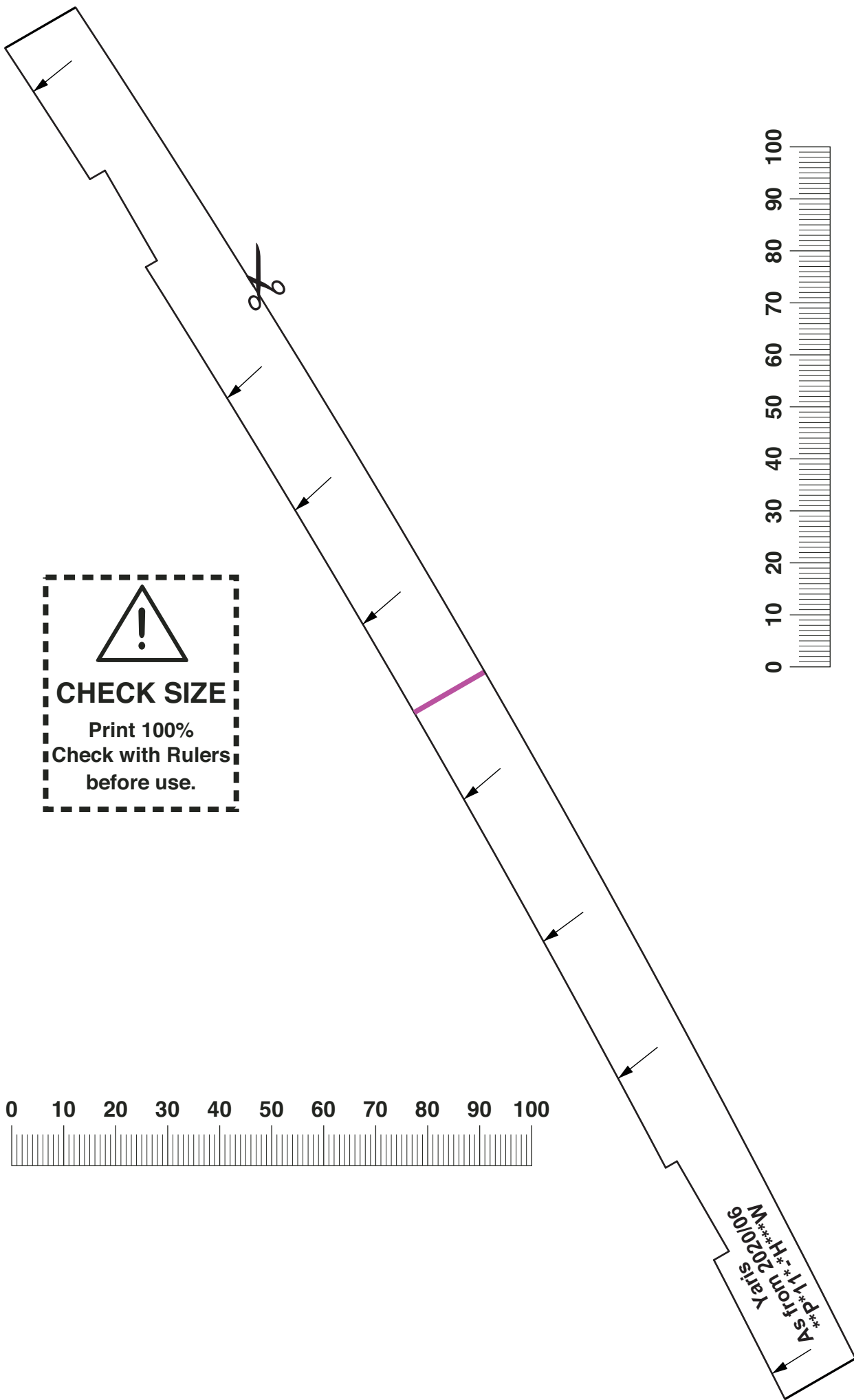

CHECK SIZE
Print 100%
Check with Rulers
before use.





TOYOTA

CHECK SHEET

Page 1 of 1

Model/Year

Yaris
As from 2020/06

Rear bumper protection
plate, plastic

VIN n°

□ □ □ □ □ □ □ □ □ □ □ □ □ □ □ □

ALWAYS A
BETTER WAY

DURING INSTALLATION

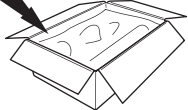
1  P/N = OK 

AFTER INSTALLATION

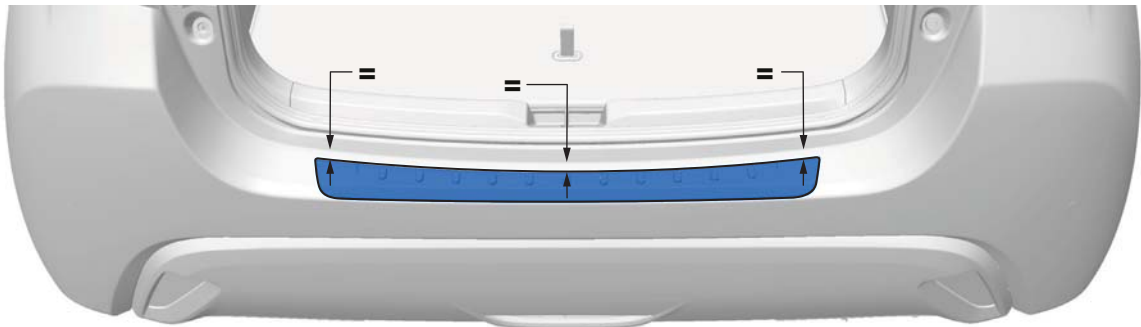
1 

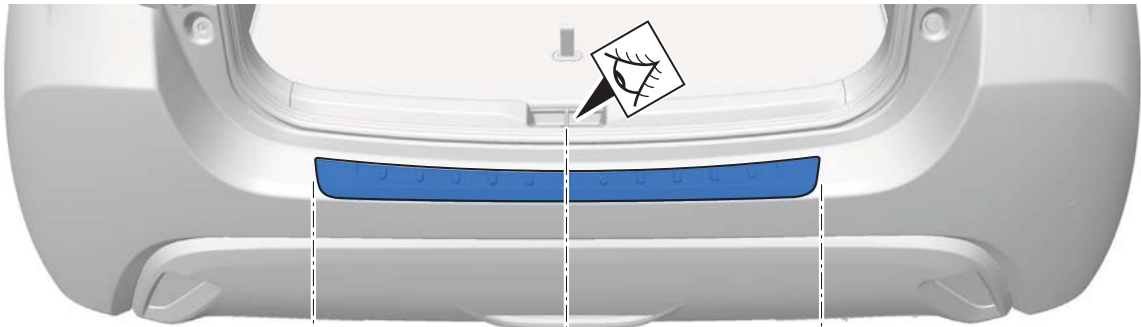
2 

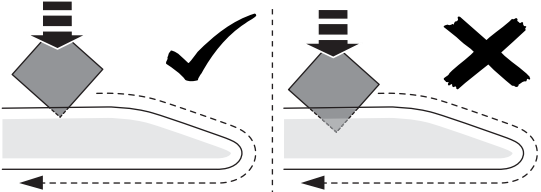
3 

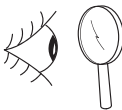
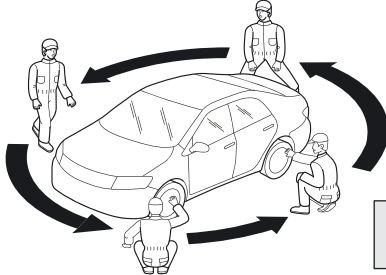
4  = OK 

Installation Date:
. . / . . /

Technician Name & Signature:

Stamp:

